

1
2
3
4
5
6
7
8
9
10
11
12
13
14
15
16
17
18
19
20
21
22
23
24
25
26
27
28
29
30
31
32
33

IN THE UNITED STATES PATENT AND TRADEMARK OFFICE

In re Application of Jed Margolin

Serial No.: 11/736,356

Examiner: Ronnie M. Mancho

Filed: 04/17/2007

Art Unit: 3664

For: SYSTEM AND METHOD FOR SAFELY FLYING UNMANNED AERIAL VEHICLES
IN CIVILIAN AIRSPACE

Mail Stop Amendment
Commissioner for Patents
P.O. Box 1450
Alexandria, VA 22313-1450

RESPONSE

Dear Sir:

In response to the Office Action mailed September 1, 2010, please consider the following remarks.

Section 1. General Summary

Claims 1 - 14 were rejected solely under 35 U.S.C. §103(a) as being obvious by combining U.S. Patent 5,904,724 (“Margolin ‘724”) and published Patent Application US 2005004723 (“Duggan”). Applicant will show that the Examiner has failed his burden of establishing a *prima facie* case of obviousness.

- a.** The Examiner has failed to distinctly point out where all of the claim elements and limitations of Applicant’s claims are present in the two cited references.

1 **b.** The Examiner has mischaracterized the two cited references as teaching all of the claim
2 elements and limitations of Applicant's claims, when they do not.

3 **c.** The present Applicant is the named inventor on one of the Examiner's cited references
4 (U.S. Patent 5,904,724).

5
6 **Section 2 - Detailed Response**

7
8 **Part A - Examiner's Detailed Action Paragraph 2**

9
10 **2. *Claims 1-14 are rejected under 35 U.S.C. 103(a) as being unpatentable over Margolin***
11 ***(5904724) in view of Duggan et al (US 2005004723).***

12
Regarding claim 1, Margolin (abstract; figs. 1-7; col. 3, lines 8-67; col. 4, lines 1-67; col. 5, lines 1-67) discloses a system for safely flying an unmanned aerial vehicle in civilian airspace comprising:

(a) a ground station 400 (fig. 1 & 4) equipped with a synthetic vision system (figs. 1 & 3; col. 4, lines 1 to col. 5, lines 67);

(b) an unmanned aerial vehicle 300 (figs. 1 & 3) capable of supporting said synthetic vision system (305, 306, 307, 311 on aircraft; col. 3, lines 8-67; col. 4, lines 1-67; col. 5, lines 1-67);

(c) a remote pilot 102 operating said ground station 400 (figs. 1&4; col. 3, lines 8-67; col. 4, lines 1-67; col. 5, lines 1-67);

(d) a communications link between said unmanned aerial vehicle 300 and said ground station 400;

(e) a system onboard said unmanned aerial vehicle 300 for detecting the presence and position of nearby aircraft (305, 306, 307, 311 on aircraft) and communicating this information to said remote pilot 102 (col. 3, lines 8-67; col. 4, lines 1-67; col. 5, lines 1-67);

whereas said remote pilot uses said synthetic vision system (305, 306, 307, 311 on aircraft) to control said unmanned aerial vehicle 300 during at least selected phases of the flight of said unmanned aerial vehicle.

1 Applicant Responds.

2 MPEP § 2142 states under the heading **ESTABLISHING A PRIMA FACIE CASE OF**
3 **OBVIOUSNESS**

a. ****>The key to supporting any rejection under 35 U.S.C. 103 is the clear articulation of the reason(s) why the claimed invention would have been obvious.** The Supreme Court in *KSR International Co. v. Teleflex Inc.*, 550 U.S. ___, ___, 82 USPQ2d 1385, 1396 (2007) noted that the analysis supporting a rejection under 35 U.S.C. 103 should be **made explicit**. The Federal Circuit has stated that "**rejections on obviousness cannot be sustained with mere conclusory statements; instead, there must be some articulated reasoning with some rational underpinning to support the legal conclusion of obviousness.**" In *re Kahn*, 441 F.3d 977, 988, 78 USPQ2d 1329, 1336 (Fed. Cir. 2006). See also *KSR*, 550 U.S. at ___, 82 USPQ2d at 1396 (quoting Federal Circuit statement with approval). <

4
5 {Emphasis added}

6
7 The Examiner has cited lengthy passages in the above rejection and made conclusory statements as
8 to their contents.

9
10 **Examiner:**

11 Regarding claim 1, Margolin (abstract; figs. 1-7; col. 3, lines 8-67; col. 4, lines 1-67; col. 5,
12 lines 1-67) discloses a system for safely flying an unmanned aerial vehicle in civilian airspace
13 comprising:

14
15 **Applicant:**

16 In Margolin '724: Column 3, lines 8-67; Column 4, lines 1-67; and Column 5, lines 1-67 form a
17 continuous passage from Column 3, line 8 to Column 5, line 67. This passage of approximately
18 1619 words forms the core of the Margolin '724 DETAILED DESCRIPTION. The remainder of the
19 Margolin '724 DETAILED DESCRIPTION teaches additional topics such as **Flight Control** (with
20 headings *Flight Control*, *Direct Control Non-Remotely Piloted Vehicles*, *Computer Mediated Non-*
21 *Remotely Piloted Vehicles*, *Second Order Flight Control Mode*, *First Order Flight Control Mode*

1 { See Column 6, line 19 - Column 8, line 3 }, the features of a Control Panel (See Column 8, line 64
2 - Column 9, line 18), the use of a Head-Mounted Display { See Column 9, lines 19 - 32 }, the use of
3 the invention for training { See Column 9, lines 33 - 63 }, and **The Database** { See Column 9, line 64
4 - Column 10, line 50. }

5

6 The Examiner cites Figures 1 - 7 in Margolin '724. These constitute all the figures in Margolin
7 '724.

8

9 The Examiner also cites the Abstract in Margolin '724. According to **608.01(b) Abstract of the**
10 **Disclosure [R-7]:**

11 **37 CFR 1.72 Title and abstract.**

12 *****

13 (b) A brief abstract of the technical disclosure in the specification must commence on a
14 separate sheet, preferably following the claims, under the heading "Abstract" or "Abstract of
15 the Disclosure." The sheet or sheets presenting the abstract may not include other parts of the
16 application or other material. The abstract in an application filed under 35 U.S.C. 111 may not
17 exceed 150 words in length. The purpose of the abstract is to enable the United States Patent
18 and Trademark Office and the public generally to determine quickly from a cursory inspection
19 the nature and gist of the technical disclosure.<

20

21 {Emphasis added}

22

23 The popular interpretation of 608.01(b) is that the purpose of the Abstract is to provide search
24 terms. In any event, the Abstract in Margolin '724 does not say anything about civilian airspace.

25

26 The Examiner has made a conclusory statement by repeating the title of Applicant's invention
27 (leaving out the words "and method") and citing the core of the DETAILED DESCRIPTION in
28 Margolin '724.

29

30 In the remaining sections of the Examiner's rejection of Applicant's Claim 1 he asserts that he has
31 found all of the elements and limitations of Applicant's invention.

32

1 It is not surprising that some of the elements of Applicant's invention are present in Margolin '724
2 since Margolin '724 is probably the pioneering patent for the use of what is now called *synthetic*
3 *vision* in remotely piloted aircraft (now commonly called Unmanned Aerial Vehicles) and
4 Applicant's present invention uses synthetic vision as an element.

5
6 However, there are limitations in Applicant's current invention that are not present in Margolin
7 '724.

8

9 **Examiner:**

10

11 whereas said remote pilot uses said synthetic vision system (305, 306, 307, 311 on aircraft) to
12 control said unmanned aerial vehicle 300 during at least selected phases of the flight of said
13 unmanned aerial vehicle.

14

15 {From Applicant's Claim 1 }

16

17 References 305, 306, 307, 311, and 300 come from Margolin '724 Figure 3 which shows the
18 structural elements in Margolin '724 Remote Aircraft Unit 300. There is nothing in these structural
19 elements which show that synthetic vision is used "during at least selected phases of the flight of
20 said unmanned aerial vehicle."

21

22 The Examiner has not shown that this limitation is taught in Margolin '724. He has only made a
23 conclusory statement.

24

25 Although *KSR* may have loosened the required reasoning that may be employed for combining prior
26 art references in an obviousness rejection, the Examiner must still provide a factual basis for each of
27 the claimed features of a rejected claim. MPEP 2143.03 entitled "**All Claim Limitations must be**
28 **Considered**" states: "all words in a claim must be considered in judging the patentability of that
29 claim against the prior art." *In re Wilson*, 424 F.2d 1382, 1385, 165 USPQ 494, 496 (CCPA 1970)."

30 If an examiner fails to address all of the recitations of a rejected claim, a *prima facie* case of

31 obviousness has not been established because such a deficiency fails to satisfy the evidentiary

32 requirements articulated by the Supreme Court in *KSR* (e.g. "the key to supporting any rejection

1 under 35 U.S.C. 103 is the clear articulation of the reason(s) why the claimed invention would have
2 been obvious” and that “a rejection under 35 U.S.C. 103 should be made explicit.”)

3 The BPAI in a recent decision (*Ex parte Wehling et al.*) stated (with emphases added):
4 “the dispositive issue in this case is **whether the Examiner has explicitly articulated a prima**
5 **facie case of obviousness which addresses all of the limitations of the claimed invention.**” The
6 BPAI was guided by the following legal principles:

7 “When determining whether a claim is obvious, an Examiner must make ‘a searching comparison of
8 the claimed invention – including all its limitations – with the teachings of the prior art.’ *In re*
9 *Ochiai*, 71 F.3d 1565, 1572 (Fed. Cir. 1995) (emphasis added). Thus, ‘obviousness requires a
10 suggestion of all limitations in a claim.’ *CFMT, Inc. v. Yieldup Int’l. Corp.*, 349 F.3d 1333, 1342
11 (Fed. Cir. 2003) (citing *In re Royka*, 490 F.2d 981, 985 (CCPA 1974)). Furthermore, in *KSR Int’l*
12 *Co. v. Teleflex Inc.*, 550 U.S. 398, 418 (2007) (citing *In re Kahn*, 441 F.3d 977, 988 (Fed. Cir.
13 2006), the Supreme Court noted that “[t]o facilitate review, this [obviousness] analysis should
14 be made explicit.” (*Ex parte Wehling et al.*, Appeal No. 2009-8111 (BPAI))

15 The BPAI in *Ex Parte Wehling et al.* held that “absent a fact-based analysis which explicitly
16 compares all the limitations of the claimed invention with the combined teachings of Gioffre and
17 Rockliffe, we are constrained to reverse the rejection of claims 1, 21, 29, and 31 and the claims
18 dependent thereon under § 103 over the combined teachings of Gioffre and Rockliffe.”

19 Note that *Ex Parte Wehling et al.* (Appeal 2009-008111, Application 10/743,118) was decided May
20 17, 2010. According to the BPAI online database the decision was issued 10/19/2010 which is after
21 the mail date of the Examiner’s rejection (9/1/2010).

22
23 **Examiner’s Detailed Action Paragraph 2 (Continued)**

24

25 The Examiner continues

26

27 *Margolin did not disclose that the vehicle is flown using an autonomous control system.*

28 *However, Duggan teach of a system for safely flying an unmanned aerial vehicle in civilian*
29 *airspace comprising:*

30 *a ground station controlling an unmanned aerial vehicle (sec. 0352, 00353), wherein*

1 *during phases of a flight of an unmanned aerial vehicle (UAV, sec 0318, 0322, 0353) when a*
 2 *synthetic vision (sec. 0356, 0365, 0388, 0390) is not used to control said unmanned aerial*
 3 *vehicle said unmanned aerial vehicle is flown using an autonomous control system (autopilot,*
 4 *sec 0346 to 0350, 0390-0329).*

5 *Therefore, it would have been obvious to one of ordinary skill in the art at the time the*
 6 *invention was made to modify Margolin as taught by Duggan for the purpose of incorporating*
 7 *an autopilot to ensure smooth transitions (Duggna abstract, sec 0014, 0085, 0086).*

8 *The different embodiments in both prior arts are combinable as it would be obvious to*
 9 *ne[sic] having ordinary skill in the art.*

10
 11 (Applicant assumes Examiner meant to say, “*The different embodiments in both prior arts are*
 12 *combinable as it would be obvious to one having ordinary skill in the art.*)

13
 14 The Examiner has mischaracterized Duggan.

15

| <u>Examiner</u> | <u>Duggan</u> |
|--|--|
| <p>Margolin did not disclose that the vehicle is flown using an autonomous control system. However, Duggan teach of a system for safely flying an unmanned aerial vehicle in civilian airspace comprising: a ground station controlling an unmanned aerial vehicle (sec. 0352, 00353),</p> | <p>[0352] In one aspect of the present invention, an operator station (also referred to as the ground control station or GCS) is designed to accommodate command and control of multiple vehicles or a single vehicle by a single operator. In accordance with one embodiment, the ground control station is platform independent and implements an application program interface that provides windowing and communications interfaces (e.g., the platform is implemented in Open Source wxWindows API). The underlying operating system is illustratively masked and enables a developer to code in a high level environment.</p> <p>[0353] In one embodiment, the ground control station incorporates several specialized user interface concepts</p> |

| | |
|---|--|
| <p>wherein during phases of a flight of an unmanned aerial vehicle (UAV, sec 0318,</p> <p>0322,</p> | <p>designed to effectively support a single operator tasked to control multiple vehicles. The GCS also illustratively supports manual control and sensor steering modes. In the manual control mode, the operator can assume control authority of the vehicles individually from the ground control station at any time in flight. In the sensor steering mode, a vehicle will autonomously fly in the direction the operator is manually pointing the on-board imaging sensor (e.g., operator views video output from a digital camera on a TV interface, computer screen display, etc.). A custom data link is illustratively, utilized to support a two-way transfer of data between the ground control station and the UAV's. These design concepts together provide a flexible, multiple vehicle control system. The details of the concepts are discussed below.</p> <p>[0318] If the pilot chooses a surveillance location outside the total FOV, then the outer loop guidance will illustratively follow a command-to-LOS mode guide law until the UAV flight path points toward the target. Once the desired staring-point comes within a minimum range threshold, the guidance automatically trips into a loiter pattern (either constant-radius or elliptical) to maintain a station with a single key-click while he/she conducts other activities. FIGS. 22A & 22B together demonstrate the surveillance-point approach scenario.</p> <p>[0322] In accordance with one aspect of the present invention, sensor-slave mode commands are generated by an autonomous line-of-sight driven function, in which the command objectives are generated by the necessities of the function rather than by an operator. For example, a function</p> |
|---|--|

| | |
|---|--|
| | <p>designed to command a raster-scan of a particular surveillance area, or a function designed to scan a long a roadway could be used to generate sensor slave commands. Another example is a function designed to generate line-of-sight commands for UAV-to-UAV rendezvous formation flying.</p> |
| 0353) | <p>[0353] In one embodiment, the ground control station incorporates several specialized user interface concepts designed to effectively support a single operator tasked to control multiple vehicles. The GCS also illustratively supports manual control and sensor steering modes. In the manual control mode, the operator can assume control authority of the vehicles individually from the ground control station at any time in flight. In the sensor steering mode, a vehicle will autonomously fly in the direction the operator is manually pointing the on-board imaging sensor (e.g., operator views video output from a digital camera on a TV interface, computer screen display, etc.). A custom data link is illustratively, utilized to support a two-way transfer of data between the ground control station and the UAV's. These design concepts together provide a flexible, multiple vehicle control system. The details of the concepts are discussed below.</p> |
| when a synthetic vision (sec. 0356, 0365, | <p>[0356] a synthetic vision display</p> <p>[0365] The two video monitors are illustratively used to display real-time data linked camera imagery from two air vehicles having cameras (of course, fewer, more or none of the vehicles might have cameras and the number of monitor displays can be altered accordingly). In accordance with one</p> |

| | |
|--|---|
| <p>0388,</p> <p>0390) is not used to control said unmanned aerial vehicle said unmanned aerial vehicle is flown using an autonomous control system</p> | <p>embodiment, camera imagery is recorded on videotapes during a mission. In accordance with one embodiment, the two repeater displays are used to provide redundant views of the GUI and synthetic vision display. The laptop illustratively serves as a GUI backup in the event that the main GUI fails.</p> <p>[0388] In one aspect of the present invention, synthetic vision display technical approach of the present invention is based upon integrating advanced simulated visuals, originally developed for training purposes, into UAV operational systems. In accordance with one embodiment, the simulated visuals are integrated with data derived from the ground control station during flight to enable real-time synthetic visuals.</p> <p>[0390] In one aspect of the present invention, through GUI display 2622, an operator can maintain a variable level of control over a UAV, from fully manual to fully autonomous, with simple user-friendly inputs. For example, if an operator decides to divert a UAV to a new route, the operator has a plurality of options to select from. The following are examples of some of the options that an operator has. Those skilled in the art should recognize that this is not an exhaustive list. In one embodiment, the operator could graphically edit the existing route on mission situation display 2629 by adding a waypoint or orbit pattern in the vicinity of a desired target region. Prior to accepting the edited route, the control system evaluates the revised route against the vehicle performance capability as well as terrain obstructions. If the route is within acceptable bounds, the control system registers the modified route and maneuvers the vehicle accordingly. In another</p> |
|--|---|

embodiment, the operator could select a park mode on selections pane 2630. After selected, the control system queues the operator to click the location of and graphical size (via a mouse) the desired orbit pattern in which the vehicle will fly while "parked" over a desired target. In another embodiment, the operator can select a manual control mode on selections pane 2630. By selecting RDC (remote directional command), for example, the control system controls the UAV into a constant altitude, heading and speed flight until the operator instructs a maneuver. While in RDC mode, the operator can either pseudo-manually direct the UAV using the control stick (e.g. joystick) or the operator can program a fixed heading, altitude and speed using the control options provided in selections pane 2630.

(autopilot, sec 0346 to 0350,

[0346] In accordance with one embodiment, an exemplary translation layer implementation will now be provided. After the guidance algorithms execute, the outputs are translated to the native vehicle autopilot commands. The equations below provide example kinematic translations from the guidance acceleration commands to native vehicle autopilot commands. These equations demonstrate the principal that vehicle motion is activated through acceleration. The methods that various vehicles employ to generate acceleration are numerous (bank angle autopilot, acceleration autopilot, heading control autopilot, altitude control autopilot, etc). Since the control algorithms described herein generate acceleration commands that can be kinematically translated into any of these native autopilot commands, the guidance algorithms truly provide a generalized library of control laws that can control any vehicle through that vehicle's native atomic functions. Ubiquitous

acceleration control techniques enable VACS to synthesize control commands for any vehicle, including air, ground, or sea-based. a_v = vertical plane acceleration command a_h = horizontal plane acceleration command $\theta = \tan^{-1} (a_h / a_v) =$ bank angle command $a_T = \sqrt{a_v^2 + a_h^2} =$ total body acceleration command $\dot{\theta} = a_h / V =$ turn rate command $\dot{\psi} = \dot{\theta} - 1 + \dot{\theta}$ = heading command $\dot{\psi} = (a_v - g) / V =$ flight path rate command $\dot{\psi} = \dot{\theta} - 1 + \dot{\theta}$ = flight path angle command $\dot{h} = V \sin(\theta) =$ climb rate command $\dot{h} = \dot{h} = 1 + \dot{h} \cdot t =$ altitude command Eq. 57

[0347] Additional functionality that can be enabled in a translation layer is means for discouraging or preventing an operator (e.g., the human or non-human operator interfacing the VACS architecture) from overdriving, stalling, or spinning the vehicle frame. This being said, limiting algorithms can also be employed in the guidance or autopilot functions.

[0348] X. Autopilot

[0349] As has been addressed, the present invention is not limited to, and does not require, a particular autopilot system. The control system and architecture embodiments of the present invention can be adapted to accommodate virtually any autopilot system.

[0350] For the purpose of providing an example, an illustrative suitable autopilot software system will now be described. The illustrative autopilot system incorporates a three-axis design (pitch and yaw with an attitude control loop in the roll axis) for vehicle stabilization and guidance

command tracking. The autopilot software design incorporates flight control techniques, which allow vehicle control algorithms to dynamically adjust airframe stabilization parameters in real-time during flight. The flight computer is programmed directly with the airframe physical properties, so that it can automatically adjust its settings with changes in airframe configuration, aerodynamic properties, and/or flight state. This provides for a simple and versatile design, and possesses the critical flexibility needed when adjustments to the airframe configuration become necessary. The three-loop design includes angular rate feedback for stability augmentation, attitude feedback for closed-loop stiffness, and acceleration feedback for command tracking. In addition, an integral controller in the forward loop illustratively provides enhanced command tracking, low frequency disturbance rejection and an automatic trim capability.

0390-0329).

{The Examiner may have meant 0390-0392. Otherwise the range is not credible}

[0390] In one aspect of the present invention, through GUI display 2622, an operator can maintain a variable level of control over a UAV, from fully manual to fully autonomous, with simple user-friendly inputs. For example, if an operator decides to divert a UAV to a new route, the operator has a plurality of options to select from. The following are examples of some of the options that an operator has. Those skilled in the art should recognize that this is not an exhaustive list. In one embodiment, the operator could graphically edit the existing route on mission situation display 2629 by adding a waypoint or orbit pattern in the vicinity of a desired target region. Prior to accepting the edited route, the control system

evaluates the revised route against the vehicle performance capability as well as terrain obstructions. If the route is within acceptable bounds, the control system registers the modified route and maneuvers the vehicle accordingly. In another embodiment, the operator could select a park mode on selections pane 2630. After selected, the control system queues the operator to click the location of and graphical size (via a mouse) the desired orbit pattern in which the vehicle will fly while "parked" over a desired target. In another embodiment, the operator can select a manual control mode on selections pane 2630. By selecting RDC (remote directional command), for example, the control system controls the UAV into a constant altitude, heading and speed flight until the operator instructs a maneuver. While in RDC mode, the operator can either pseudo-manually direct the UAV using the control stick (e.g. joystick) or the operator can program a fixed heading, altitude and speed using the control options provided in selections pane 2630.

[0391] The described Intelligent displays with smart variables represent an effective approach to actively displaying information for different types of vehicles. However, a problem can arise when a new vehicle is integrated into the ground control station with a completely foreign command and control interface. Under these circumstances, the ground control station is not concerned about displaying data, but is tasked to provide a command and control interface for the operator to perform the required operations. This conundrum is the motivation for another embodiment of the present invention, namely, the integration of vehicle specific panels in the ground control station.

[0392] In one embodiment, a generic vehicle class (GVC) is illustratively a software component that provides a rapid development environment API to add new vehicle classes and types to the ground control station. The GVC also illustratively serves as a software construct that allows the inclusion of multiple vehicles within the ground control station framework. One of the variables in the application is a vector of pointers to a generic vehicle class. This list is constructed by allocating new specific vehicles and returning a type case to the base generic vehicle class. When a new vehicle is integrated into the ground control station, the generic vehicle class provides all of the virtual functions to integrate with system control components (e.g., to integrate with a map display, a communications package, PCIG imagery and/or appropriate display windows). An important object in the application framework is illustratively a pointer to the current vehicle generic class. When the user switches vehicles, this pointer is updated and all displays grab the appropriate smart variables from the pointer to the new base class. This is the mechanism by which windows immediately update to the current vehicle information whenever the user switches vehicles. The default windows use the pointer to the current vehicle to grab information. In this manner, if the user switches to a new vehicle with a different set of datalink variables, that fact is immediately apparent on the display windows.

Therefore, it would have been obvious to one of ordinary skill in the art at the time the invention

was made to modify Margolin as taught by Duggan for the purpose of incorporating an autopilot to ensure smooth transitions (Duggan abstract, sec 0014, 0085, 0086).

The different embodiments in both prior arts are combinable as it would be obvious to one [sic] having ordinary skill in the art.

Abstract

Embodiments are disclosed for a vehicle control system and related sub-components that together provide an operator with a plurality of specific modes of operation, wherein various modes of operation incorporate different levels of autonomous control. Through a control user interface, an operator can move between certain modes of control even after vehicle deployment. Specialized autopilot system components and methods are employed to ensure smooth transitions between control modes. Empowered by the multi-modal control system, an operator can even manage multiple vehicles simultaneously.

[0014] Embodiments of the present invention pertain to a hierarchical control system, user interface system, and control architecture that together incorporate a broad range of user-selectable control modes representing variable levels of autonomy and vehicle control functionality. A unified autopilot is provided to process available modes and mode transitions. An intelligence synthesizer is illustratively provided to assist in resolving functional conflicts and transitioning between control modes, although certain resolutions and transitions can be incorporated directly into the functional sub-components associated with the different control modes. In accordance with one embodiment, all modes and transitions are funneled through an acceleration-based autopilot system. Accordingly, control commands and transitions are generally reduced to an acceleration vector to

be processed by a centralized autopilot system.

[0085] As will be discussed in greater detail below, the control system and architecture embodiments of the present invention essentially enable any autopilot design to support control of a vehicle in numerous control modes that are executed with switches between modes during flight. All control modes are supported even in the presence of sensor errors, such as accelerometer and gyro biases. This robustness is at least partially attributable to the fact that the closed-loop system, in all control modes, is essentially slaved to an inertial path and, hence, the sensor biases wash out in the closed loop, assuming the biases are not so grossly large that they induce stability problems in the autopilot system. Furthermore, winds are generally not an issue in the overall control scheme in that the flight control system will regulate to the inertial path, adjusting for winds automatically in the closed loop. Given the precision afforded by inertial navigation aided by GPS technology, inertial path regulation offers a highly effective and robust UAV control approach. Generally speaking, the autopilot system functions such that winds, medium Dryden turbulence levels, sensor errors, airframe aerodynamic and mass model parameter uncertainties, servo non-linearity (slew rate limits, etc.), and various other atmospheric and noise disturbances will non have a critically negative impact on flight path regulation.

[0086] Component 408 receives commands generated by component 404 and filtered by autopilot component 406. The commands received by component 408 are executed to actually manipulate the vehicle's control surfaces. Autopilot component 406 then continues to monitor vehicle stabilization

| | |
|--|--|
| | and/or command tracking, making additional commands to component 408 as necessary. |
|--|--|

1

2 At the beginning of this subsection, the Examiner asserts, “Margolin did not disclose that the
3 vehicle is flown using an autonomous control system. However, Duggan teach of a system for
4 safely flying an unmanned aerial vehicle in civilian airspace comprising: ...”

5

6 The Examiner’s statement, “However, Duggan teach of a system for safely flying an unmanned
7 aerial vehicle in civilian airspace comprising: ...” is conclusory and is not supported by the
8 Examiner’s citations to Duggan.

9

10 In addition, none of the Duggan citations teach that either synthetic vision or Duggan’s Variable
11 Autonomy System is used “during at least selected phases of the flight of said unmanned aerial
12 vehicle” which is a limitation in Applicant’s Claim 1.

13

14 Duggan fails to teach the limitation that his Variable Autonomy System is used during selected
15 phases of a UAV’s flight and Margolin ‘724 fails to teach the limitation that synthetic vision is used
16 during selected phases of a UAV’s flight. Therefore, the combination of Duggan and Margolin ‘724
17 does not read on Applicant’s Claim 1.

18

19 As cited above by Applicant, MPEP 2143.03 “**All Claim Limitations must be Considered**” states:
20 “all words in a claim must be considered in judging the patentability of that claim against the prior
21 art.” *In re Wilson*, 424 F.2d 1382, 1385, 165 USPQ 494, 496 (CCPA 1970).”

22

23 The Examiner has failed his duty under MPEP 2143.03 (and in view of *Wehling*) to present a *prima*
24 *facie* case of obviousness for rejecting Applicant’s Claim 1.

25

26 **Examiner’s Regarding Claim 2**, a claim dependent on Claim 1. Applicant has shown that Claim 1
27 is nonobvious. Therefore, under **2143.03 All Claim Limitations Must Be Considered**, Claim 2 is
28 non-obvious.

29

2143.03 All Claim Limitations Must Be ~~*>~~Considered< [R-6]**

1 ** "All words in a claim must be considered in judging the patentability of that claim against
2 the prior art." *In re Wilson*, 424 F.2d 1382, 1385, 165 USPQ 494, 496 (CCPA 1970). If an
3 independent claim is nonobvious under 35 U.S.C. 103, then any claim depending therefrom is
4 nonobvious. *In re Fine*, 837 F.2d 1071, 5 USPQ2d 1596 (Fed. Cir. 1988).

5
6 **Examiner's Regarding Claim 3**, a claim dependent on Claim 1. Applicant has shown that Claim 1
7 is nonobvious. Therefore, under 2143.03 **All Claim Limitations Must Be Considered**, Claim 3 is
8 non-obvious.

9 **2143.03 All Claim Limitations Must Be ~~Considered~~ [R-6]**

10 ** "All words in a claim must be considered in judging the patentability of that claim against
11 the prior art." *In re Wilson*, 424 F.2d 1382, 1385, 165 USPQ 494, 496 (CCPA 1970). If an
12 independent claim is nonobvious under 35 U.S.C. 103, then any claim depending therefrom is
13 nonobvious. *In re Fine*, 837 F.2d 1071, 5 USPQ2d 1596 (Fed. Cir. 1988).

14
15 **Examiner's Regarding Claim 4**, a claim dependent on Claim 1. Applicant has shown that Claim 1
16 is nonobvious. Therefore, under 2143.03 **All Claim Limitations Must Be Considered**, Claim 4 is
17 non-obvious.

18 **2143.03 All Claim Limitations Must Be ~~Considered~~ [R-6]**

19 ** "All words in a claim must be considered in judging the patentability of that claim against
20 the prior art." *In re Wilson*, 424 F.2d 1382, 1385, 165 USPQ 494, 496 (CCPA 1970). If an
21 independent claim is nonobvious under 35 U.S.C. 103, then any claim depending therefrom is
22 nonobvious. *In re Fine*, 837 F.2d 1071, 5 USPQ2d 1596 (Fed. Cir. 1988).

23
24 **Examiner:**

Regarding claim 5, Margolin (abstract; figs. 1-7; col. 3, lines 8-67; col. 4, lines 1-67; col. 5, lines 1-67) in view of Duggan disclose a system for safely flying an unmanned aerial vehicle in civilian airspace comprising:

- (a) a ground station equipped with a synthetic vision system;
- (b) an unmanned aerial vehicle capable of supporting said synthetic vision system;
- (c) a remote pilot operating said ground station;

- (d) a communications link between said unmanned aerial vehicle and said ground station;
- e) a system onboard said unmanned aerial vehicle for detecting the presence and position of nearby aircraft and communicating this information to said remote pilot;

whereas said remote pilot uses said synthetic vision system to control said unmanned aerial vehicle during at least selected phases of the flight of said unmanned aerial vehicle, and during those phases of the flight of said unmanned aerial vehicle when said synthetic vision system is not used to control said unmanned aerial vehicle said unmanned aerial vehicle is flown using an autonomous control system, and

whereas the selected phases of the flight of said unmanned aerial vehicle comprise:

(a) when said unmanned aerial vehicle is within a selected range of an airport or other designated location and is below a first specified altitude;

(b) when said unmanned aerial vehicle is outside said selected range of an airport or other designated location and is below a second specified altitude.

1

2 **Applicant:**

3 In Margolin '724: Column 3, lines 8-67; Column 4, lines 1-67; and Column 5, lines 1-67 form a
4 continuous passage from Column 3, line 8 to Column 5, line 67. This passage of approximately
5 1619 words forms the core of the Margolin '724 DETAILED DESCRIPTION. The remainder of the
6 Margolin '724 DETAILED DESCRIPTION teaches additional topics such as **Flight Control** (with
7 headings *Flight Control*, *Direct Control Non-Remotely Piloted Vehicles*, *Computer Mediated Non-*
8 *Remotely Piloted Vehicles*, *Second Order Flight Control Mode*, *First Order Flight Control Mode*
9 {See Column 6, line 19 - Column 8, line 3}, the features of a Control Panel (See Column 8, line 64
10 - Column 9, line 18}, the use of a Head-Mounted Display {See Column 9, lines 19 - 32}, the use of
11 the invention for training {See Column 9, lines 33 - 63}, and **The Database** {See Column 9, line 64
12 - Column 10, line 50.}

13

14 The Examiner cites Figures 1 - 7 in Margolin '724. These constitute all the figures in Margolin
15 '724.

16

17 The Examiner also cites the Abstract in Margolin '724. According to **608.01(b) Abstract of the**

18 **Disclosure [R-7]:**

19 **37 CFR 1.72 Title and abstract.**

1 *****

2 (b) A brief abstract of the technical disclosure in the specification must commence on a
3 separate sheet, preferably following the claims, under the heading "Abstract" or "Abstract of
4 the Disclosure." The sheet or sheets presenting the abstract may not include other parts of the
5 application or other material. The abstract in an application filed under 35 U.S.C. 111 may not
6 exceed 150 words in length. The purpose of the abstract is to enable the United States Patent
7 and Trademark Office and the public generally to determine quickly from a cursory inspection
8 the nature and gist of the technical disclosure.<

9
10 {Emphasis added}

11
12 The popular interpretation of 608.01(b) is that the purpose of the Abstract is to provide search
13 terms. In any event, the Abstract in Margolin '724 does not say anything about civilian airspace.

14
15 The Examiner has made a conclusory statement by repeating the title of Applicant's invention
16 (leaving out the words "and method") and citing the core of the DETAILED DESCRIPTION in
17 Margolin '724.

18
19 In the remaining sections of the Examiner's rejection of Applicant's Claim 5 he asserts that he has
20 found all of the elements and limitations of Applicant's invention.

21
22 It is not surprising that some of the elements of Applicant's invention are present in Margolin '724
23 since Margolin '724 is probably the pioneering patent for the use of what is now called *synthetic*
24 *vision* in remotely piloted aircraft (now commonly called Unmanned Aerial Vehicles) and
25 Applicant's present invention uses synthetic vision as an element.

26
27 However, there are limitations in Applicant's current invention that are not present in Margolin
28 '724.

29
30 Examiner:

31 whereas said remote pilot uses said synthetic vision system to control said unmanned aerial
32 vehicle during at least selected phases of the flight of said unmanned aerial vehicle, and during

1 those phases of the flight of said unmanned aerial vehicle when said synthetic vision system is
2 not used to control said unmanned aerial vehicle said unmanned aerial vehicle is flown using an
3 autonomous control system, and

4
5 whereas the selected phases of the flight of said unmanned aerial vehicle comprise:

6 (a) when said unmanned aerial vehicle is within a selected range of an airport or other designated
7 location and is below a first specified altitude;

8 (b) when said unmanned aerial vehicle is outside said selected range of an airport or other
9 designated location and is below a second specified altitude.

10
11 The Examiner has not even attempted to show where these limitations are taught in Margolin '724.
12 As noted, he has cited the core of the Margolin '724 DETAILED DESCRIPTION, all of the
13 drawings, and the abstract. His rejection is purely conclusory and does not follow the requirements
14 for making a *prima facie* rejection required by MPEP § 2143.03 **All Claim Limitations Must Be**
15 **Considered**, *KSR*, and *Wehling*, as well as MPEP § 2142 **ESTABLISHING A PRIMA FACIE**
16 **CASE OF OBVIOUSNESS**.

17
18 The Examiner continues:

19 *Margolin did not disclose that the vehicle is flown using an autonomous control system.*

20 *However, Duggan teach of a system for safely flying an unmanned aerial vehicle in civilian*
21 *airspace comprising:*

22 *a ground station controlling an unmanned aerial vehicle (sec. 0352, 00353), wherein*
23 *during phases of a flight of an unmanned aerial vehicle (UAV, sec 0318, 0322, 0353) when a*
24 *synthetic vision (sec. 0356, 0365, 0388, 0390) is not used to control said unmanned aerial*
25 *vehicle said unmanned aerial vehicle is flown using an autonomous control system (autopilot,*
26 *sec 0346 to 0350, 0390-0329).*

27 *Therefore, it would have been obvious to one of ordinary skill in the art at the time the*
28 *invention was made to modify Margolin as taught by Duggan for the purpose of incorporating*
29 *an autopilot to ensure smooth transitions (Duggna abstract, sec 0014, 0085, 0086).*

- 1 *The different embodiments in both prior arts are combinable as it would be obvious to ne*
- 2 *having ordinary skill in the art.*

| <u>Examiner</u> | <u>Duggan</u> |
|---|---|
| <p>Margolin did not disclose that the vehicle is flown using an autonomous control system. However, Duggan teach of a system for safely flying an unmanned aerial vehicle in civilian airspace comprising: a ground station controlling an unmanned aerial vehicle (sec. 0352, 00353),</p> | <p>[0352] In one aspect of the present invention, an operator station (also referred to as the ground control station or GCS) is designed to accommodate command and control of multiple vehicles or a single vehicle by a single operator. In accordance with one embodiment, the ground control station is platform independent and implements an application program interface that provides windowing and communications interfaces (e.g., the platform is implemented in Open Source wxWindows API). The underlying operating system is illustratively masked and enables a developer to code in a high level environment.</p> <p>[0353] In one embodiment, the ground control station incorporates several specialized user interface concepts designed to effectively support a single operator tasked to control multiple vehicles. The GCS also illustratively supports manual control and sensor steering modes. In the manual control mode, the operator can assume control authority of the vehicles individually from the ground control station at any time in flight. In the sensor steering mode, a vehicle will autonomously fly in the direction the operator is manually pointing the on-board imaging sensor (e.g., operator views video output from a digital camera on a TV interface, computer screen display, etc.). A custom data link is illustratively, utilized to support a two-way transfer of data between the ground control station and the UAV's. These design concepts together provide a flexible, multiple vehicle</p> |

| | |
|--|---|
| <p>wherein during phases of a flight of an unmanned aerial vehicle (UAV, sec 0318,</p> <p>0322,</p> <p>0353)</p> | <p>control system. The details of the concepts are discussed below.</p> <p>[0318] If the pilot chooses a surveillance location outside the total FOV, then the outer loop guidance will illustratively follow a command-to-LOS mode guide law until the UAV flight path points toward the target. Once the desired starting-point comes within a minimum range threshold, the guidance automatically trips into a loiter pattern (either constant-radius or elliptical) to maintain a station with a single key-click while he/she conducts other activities. FIGS. 22A & 22B together demonstrate the surveillance-point approach scenario.</p> <p>[0322] In accordance with one aspect of the present invention, sensor-slave mode commands are generated by an autonomous line-of-sight driven function, in which the command objectives are generated by the necessities of the function rather than by an operator. For example, a function designed to command a raster-scan of a particular surveillance area, or a function designed to scan a long a roadway could be used to generate sensor slave commands. Another example is a function designed to generate line-of-sight commands for UAV-to-UAV rendezvous formation flying.</p> <p>[0353] In one embodiment, the ground control station incorporates several specialized user interface concepts designed to effectively support a single operator tasked to control multiple vehicles. The GCS also illustratively supports manual control and sensor steering modes. In the manual control mode, the operator can assume control authority of the vehicles individually from the ground control station at any</p> |
|--|---|

| | |
|-------------------------------------|--|
| | <p>time in flight. In the sensor steering mode, a vehicle will autonomously fly in the direction the operator is manually pointing the on-board imaging sensor (e.g., operator views video output from a digital camera on a TV interface, computer screen display, etc.). A custom data link is illustratively, utilized to support a two-way transfer of data between the ground control station and the UAV's. These design concepts together provide a flexible, multiple vehicle control system. The details of the concepts are discussed below.</p> |
| when a synthetic vision (sec. 0356, | [0356] a synthetic vision display |
| 0365, | [0365] The two video monitors are illustratively used to display real-time data linked camera imagery from two air vehicles having cameras (of course, fewer, more or none of the vehicles might have cameras and the number of monitor displays can be altered accordingly). In accordance with one embodiment, camera imagery is recorded on videotapes during a mission. In accordance with one embodiment, the two repeater displays are used to provide redundant views of the GUI and synthetic vision display. The laptop illustratively serves as a GUI backup in the event that the main GUI fails. |
| 0388, | [0388] In one aspect of the present invention, synthetic vision display technical approach of the present invention is based upon integrating advanced simulated visuals, originally developed for training purposes, into UAV operational systems. In accordance with one embodiment, the simulated visuals are integrated with data derived from the ground control station during flight to enable real-time synthetic |

| | |
|---|--|
| <p>0390) is not used to control said unmanned aerial vehicle said unmanned aerial vehicle is flown using an autonomous control system</p> | <p>visuals.</p> <p>[0390] In one aspect of the present invention, through GUI display 2622, an operator can maintain a variable level of control over a UAV, from fully manual to fully autonomous, with simple user-friendly inputs. For example, if an operator decides to divert a UAV to a new route, the operator has a plurality of options to select from. The following are examples of some of the options that an operator has. Those skilled in the art should recognize that this is not an exhaustive list. In one embodiment, the operator could graphically edit the existing route on mission situation display 2629 by adding a waypoint or orbit pattern in the vicinity of a desired target region. Prior to accepting the edited route, the control system evaluates the revised route against the vehicle performance capability as well as terrain obstructions. If the route is within acceptable bounds, the control system registers the modified route and maneuvers the vehicle accordingly. In another embodiment, the operator could select a park mode on selections pane 2630. After selected, the control system queues the operator to click the location of and graphical size (via a mouse) the desired orbit pattern in which the vehicle will fly while "parked" over a desired target. In another embodiment, the operator can select a manual control mode on selections pane 2630. By selecting RDC (remote directional command), for example, the control system controls the UAV into a constant altitude, heading and speed flight until the operator instructs a maneuver. While in RDC mode, the operator can either pseudo-manually direct the UAV using the control stick (e.g. joystick) or the operator can program a fixed heading, altitude and speed using the control</p> |
|---|--|

(autopilot, sec 0346 to 0350,

options provided in selections pane 2630.

[0346] In accordance with one embodiment, an exemplary translation layer implementation will now be provided. After the guidance algorithms execute, the outputs are translated to the native vehicle autopilot commands. The equations below provide example kinematic translations from the guidance acceleration commands to native vehicle autopilot commands. These equations demonstrate the principal that vehicle motion is activated through acceleration. The methods that various vehicles employ to generate acceleration are numerous (bank angle autopilot, acceleration autopilot, heading control autopilot, altitude control autopilot, etc). Since the control algorithms described herein generate acceleration commands that can be kinematically translated into any of these native autopilot commands, the guidance algorithms truly provide a generalized library of control laws that can control any vehicle through that vehicle's native atomic functions. Ubiquitous acceleration control techniques enable VACS to synthesize control commands for any vehicle, including air, ground, or sea-based. a_v = vertical plane acceleration command a_h = horizontal plane acceleration command $\theta = \tan^{-1} \left(\frac{a_h}{a_v} \right)$ = bank angle command $a_T = \sqrt{a_v^2 + a_h^2}$ = total body acceleration command $\dot{\theta} = \frac{a_h}{V}$ = turn rate command $\dot{\theta} = \dot{\theta} - 1 + \dot{t}$ = heading command $\dot{\theta} = \left(\frac{a_v - g}{V} \right)$ = flight path rate command $\dot{\theta} = \dot{\theta} - 1 + \dot{t}$ = flight path angle command $\dot{h} = V \sin(\theta)$ = climb rate command $\dot{h} = \dot{h} = 1 + \dot{h} \cdot \dot{t}$ = altitude command Eq. 57

[0347] Additional functionality that can be enabled in a translation layer is means for discouraging or preventing an

operator (e.g., the human or non-human operator interfacing the VACS architecture) from overdriving, stalling, or spinning the vehicle frame. This being said, limiting algorithms can also be employed in the guidance or autopilot functions.

[0348] X. Autopilot

[0349] As has been addressed, the present invention is not limited to, and does not require, a particular autopilot system. The control system and architecture embodiments of the present invention can be adapted to accommodate virtually any autopilot system.

[0350] For the purpose of providing an example, an illustrative suitable autopilot software system will now be described. The illustrative autopilot system incorporates a three-axis design (pitch and yaw with an attitude control loop in the roll axis) for vehicle stabilization and guidance command tracking. The autopilot software design incorporates flight control techniques, which allow vehicle control algorithms to dynamically adjust airframe stabilization parameters in real-time during flight. The flight computer is programmed directly with the airframe physical properties, so that it can automatically adjust its settings with changes in airframe configuration, aerodynamic properties, and/or flight state. This provides for a simple and versatile design, and possesses the critical flexibility needed when adjustments to the airframe configuration become necessary. The three-loop design includes angular rate feedback for stability augmentation, attitude feedback for closed-loop stiffness, and acceleration feedback for command tracking. In addition, an

0390-0329).

integral controller in the forward loop illustratively provides enhanced command tracking, low frequency disturbance rejection and an automatic trim capability.

{The Examiner may have meant 0390-0392. Otherwise the range is not credible}

[0390] In one aspect of the present invention, through GUI display 2622, an operator can maintain a variable level of control over a UAV, from fully manual to fully autonomous, with simple user-friendly inputs. For example, if an operator decides to divert a UAV to a new route, the operator has a plurality of options to select from. The following are examples of some of the options that an operator has. Those skilled in the art should recognize that this is not an exhaustive list. In one embodiment, the operator could graphically edit the existing route on mission situation display 2629 by adding a waypoint or orbit pattern in the vicinity of a desired target region. Prior to accepting the edited route, the control system evaluates the revised route against the vehicle performance capability as well as terrain obstructions. If the route is within acceptable bounds, the control system registers the modified route and maneuvers the vehicle accordingly. In another embodiment, the operator could select a park mode on selections pane 2630. After selected, the control system queues the operator to click the location of and graphical size (via a mouse) the desired orbit pattern in which the vehicle will fly while "parked" over a desired target. In another embodiment, the operator can select a manual control mode on selections pane 2630. By selecting RDC (remote directional command), for example, the control system controls the UAV into a constant altitude, heading and speed

flight until the operator instructs a maneuver. While in RDC mode, the operator can either pseudo-manually direct the UAV using the control stick (e.g. joystick) or the operator can program a fixed heading, altitude and speed using the control options provided in selections pane 2630.

[0391] The described Intelligent displays with smart variables represent an effective approach to actively displaying information for different types of vehicles. However, a problem can arise when a new vehicle is integrated into the ground control station with a completely foreign command and control interface. Under these circumstances, the ground control station is not concerned about displaying data, but is tasked to provide a command and control interface for the operator to perform the required operations. This conundrum is the motivation for another embodiment of the present invention, namely, the integration of vehicle specific panels in the ground control station.

[0392] In one embodiment, a generic vehicle class (GVC) is illustratively a software component that provides a rapid development environment API to add new vehicle classes and types to the ground control station. The GVC also illustratively serves as a software construct that allows the inclusion of multiple vehicles within the ground control station framework. One of the variables in the application is a vector of pointers to a generic vehicle class. This list is constructed by allocating new specific vehicles and returning a type case to the base generic vehicle class. When a new vehicle is integrated into the ground control station, the generic vehicle class provides all of the virtual functions to

integrate with system control components (e.g., to integrate with a map display, a communications package, PCIG imagery and/or appropriate display windows). An important object in the application framework is illustratively a pointer to the current vehicle generic class. When the user switches vehicles, this pointer is updated and all displays grab the appropriate smart variables from the pointer to the new base class. This is the mechanism by which windows immediately update to the current vehicle information whenever the user switches vehicles. The default windows use the pointer to the current vehicle to grab information. In this manner, if the user switches to a new vehicle with a different set of datalink variables, that fact is immediately apparent on the display windows.

Therefore, it would have been obvious to one of ordinary skill in the art at the time the invention was made to modify Margolin as taught by Duggan for the purpose of incorporating an autopilot to ensure smooth transitions (Duggna abstract, sec 0014, 0085, 0086).

The different embodiments in both prior arts are combinable as it would be obvious to ne[sic] having ordinary skill in the art.

Abstract

Embodiments are disclosed for a vehicle control system and related sub-components that together provide an operator with a plurality of specific modes of operation, wherein various modes of operation incorporate different levels of autonomous control. Through a control user interface, an operator can move between certain modes of control even after vehicle deployment. Specialized autopilot system components and methods are employed to ensure smooth transitions between

control modes. Empowered by the multi-modal control system, an operator can even manage multiple vehicles simultaneously.

[0014] Embodiments of the present invention pertain to a hierarchical control system, user interface system, and control architecture that together incorporate a broad range of user-selectable control modes representing variable levels of autonomy and vehicle control functionality. A unified autopilot is provided to process available modes and mode transitions. An intelligence synthesizer is illustratively provided to assist in resolving functional conflicts and transitioning between control modes, although certain resolutions and transitions can be incorporated directly into the functional sub-components associated with the different control modes. In accordance with one embodiment, all modes and transitions are funneled through an acceleration-based autopilot system. Accordingly, control commands and transitions are generally reduced to an acceleration vector to be processed by a centralized autopilot system.

[0085] As will be discussed in greater detail below, the control system and architecture embodiments of the present invention essentially enable any autopilot design to support control of a vehicle in numerous control modes that are executed with switches between modes during flight. All control modes are supported even in the presence of sensor errors, such as accelerometer and gyro biases. This robustness is at least partially attributable to the fact that the closed-loop system, in all control modes, is essentially slaved to an inertial path and, hence, the sensor biases wash out in the closed loop,

assuming the biases are not so grossly large that they induce stability problems in the autopilot system. Furthermore, winds are generally not an issue in the overall control scheme in that the flight control system will regulate to the inertial path, adjusting for winds automatically in the closed loop. Given the precision afforded by inertial navigation aided by GPS technology, inertial path regulation offers a highly effective and robust UAV control approach. Generally speaking, the autopilot system functions such that winds, medium Dryden turbulence levels, sensor errors, airframe aerodynamic and mass model parameter uncertainties, servo non-linearity (slew rate limits, etc.), and various other atmospheric and noise disturbances will non have a critically negative impact on flight path regulation.

[0086] Component 408 receives commands generated by component 404 and filtered by autopilot component 406. The commands received by component 408 are executed to actually manipulate the vehicle's control surfaces. Autopilot component 406 then continues to monitor vehicle stabilization and/or command tracking, making additional commands to component 408 as necessary.

1

2

3 At the beginning of this subsection, the Examiner asserts, “Margolin did not disclose that the
4 vehicle is flown using an autonomous control system. However, Duggan teach of a system for
5 safely flying an unmanned aerial vehicle in civilian airspace comprising: ...”

6

7 The Examiner’s statement, “However, Duggan teach of a system for safely flying an unmanned
8 aerial vehicle in civilian airspace comprising: ...” is conclusory and is not supported by the
9 Examiner’s citations to Duggan.

10

1 In addition, none of the Duggan citations teach the limitations in Applicant's Claim 5 that either
2 synthetic vision or Duggan's Variable Autonomy System is used:

- 3 1. "during at least selected phases of the flight of said unmanned aerial vehicle"
- 4 2. that the selected phases comprise:
 - 5 (a) when said unmanned aerial vehicle is within a selected range of an airport or other
6 designated location and is below a first specified altitude;
 - 7 (b) when said unmanned aerial vehicle is outside said selected range of an airport or other
8 designated location and is below a second specified altitude.

9
10 Duggan fails to teach the limitation that his Variable Autonomy System is used during selected
11 phases of a UAV's flight and Margolin '724 fails to teach the limitation that synthetic vision is used
12 during selected phases of a UAV's flight. Therefore, the combination of Duggan and Margolin '724
13 does not read on Applicant's Claim 5.

14
15 As cited above by Applicant, MPEP 2143.03 "**All Claim Limitations must be Considered**" states:
16 "all words in a claim must be considered in judging the patentability of that claim against the prior
17 art." *In re Wilson*, 424 F.2d 1382, 1385, 165 USPQ 494, 496 (CCPA 1970)."

18
19 The Examiner has failed his duty under MPEP 2143.03 (and in view of *Wehling*) to present a *prima*
20 *facie* case of obviousness for rejecting Applicant's Claim 5.

21
22 **Examiner's Regarding Claim 6**, a claim dependent on Claim 5. Applicant has shown that Claim 5
23 is nonobvious. Therefore, under **2143.03 All Claim Limitations Must Be Considered**, Claim 6 is
24 non-obvious.

25 **2143.03 All Claim Limitations Must Be ~~**>~~Considered< [R-6]**

26 ** "All words in a claim must be considered in judging the patentability of that claim against
27 the prior art." *In re Wilson*, 424 F.2d 1382, 1385, 165 USPQ 494, 496 (CCPA 1970). If an
28 independent claim is nonobvious under 35 U.S.C. 103, then any claim depending therefrom is
29 nonobvious. *In re Fine*, 837 F.2d 1071, 5 USPQ2d 1596 (Fed. Cir. 1988).

30

1 **Examiner's Regarding Claim 7**, a claim dependent on Claim 5. Applicant has shown that Claim 5
2 is nonobvious. Therefore, under **2143.03 All Claim Limitations Must Be Considered**, Claim 7 is
3 non-obvious.

4 **2143.03 All Claim Limitations Must Be ~~Considered~~ [R-6]**

5 ** "All words in a claim must be considered in judging the patentability of that claim against
6 the prior art." *In re Wilson*, 424 F.2d 1382, 1385, 165 USPQ 494, 496 (CCPA 1970). If an
7 independent claim is nonobvious under 35 U.S.C. 103, then any claim depending therefrom is
8 nonobvious. *In re Fine*, 837 F.2d 1071, 5 USPQ2d 1596 (Fed. Cir. 1988).

9
10 **Examiner:**

Regarding claim 8, Margolin (abstract; figs. 1-7; col. 3, lines 8-67; col. 4, lines 1-67; col. 5, lines 1-67) in view of Duggan disclose a method for safely flying an unmanned aerial vehicle as part of a unmanned aerial system equipped with a synthetic vision system in civilian airspace comprising the steps of-

(a) using a remote pilot to fly said unmanned aerial vehicle using synthetic vision during at least selected phases of the flight of said unmanned aerial vehicle, and during those phases of the flight of said unmanned aerial vehicle when said synthetic vision system is not used to control said unmanned aerial vehicle an autonomous control system is used to fly said unmanned aerial vehicle;

(b) providing a system onboard said unmanned aerial vehicle for detecting the presence and position of nearby aircraft and communicating this information to said remote pilot.

11

12 **Applicant:**

13 In Margolin '724: Column 3, lines 8-67; Column 4, lines 1-67; and Column 5, lines 1-67 form a
14 continuous passage from Column 3, line 8 to Column 5, line 67. This passage of approximately
15 1619 words forms the core of the Margolin '724 DETAILED DESCRIPTION. The remainder of the
16 Margolin '724 DETAILED DESCRIPTION teaches additional topics such as **Flight Control** (with
17 headings *Flight Control*, *Direct Control Non-Remotely Piloted Vehicles*, *Computer Mediated Non-*
18 *Remotely Piloted Vehicles*, *Second Order Flight Control Mode*, *First Order Flight Control Mode*
19 {See Column 6, line 19 - Column 8, line 3}, the features of a Control Panel (See Column 8, line 64
20 - Column 9, line 18}, the use of a Head-Mounted Display {See Column 9, lines 19 - 32}, the use of

1 the invention for training {See Column 9, lines 33 - 63}, and **The Database** {See Column 9, line 64
2 - Column 10, line 50.}

3
4 The Examiner cites Figures 1 - 7 in Margolin '724. These constitute all the figures in Margolin
5 '724.

6
7 The Examiner also cites the Abstract in Margolin '724. According to **608.01(b) Abstract of the**
8 **Disclosure [R-7]:**

9 **37 CFR 1.72 Title and abstract.**

10 *****

11 (b) A brief abstract of the technical disclosure in the specification must commence on a
12 separate sheet, preferably following the claims, under the heading "Abstract" or "Abstract of
13 the Disclosure." The sheet or sheets presenting the abstract may not include other parts of the
14 application or other material. The abstract in an application filed under 35 U.S.C. 111 may not
15 exceed 150 words in length. The purpose of the abstract is to enable the United States Patent
16 and Trademark Office and the public generally to determine quickly from a cursory inspection
17 the nature and gist of the technical disclosure.<

18
19 {Emphasis added}

20
21 The popular interpretation of 608.01(b) is that the purpose of the Abstract is to provide search
22 terms. In any event, the Abstract in Margolin '724 does not say anything about civilian airspace.

23
24 The Examiner has made a conclusory statement by repeating the title of Applicant's invention
25 (leaving out the words "and method") and citing the core of the DETAILED DESCRIPTION in
26 Margolin '724.

27
28 In the remaining sections of the Examiner's rejection of Applicant's Claim 8 he asserts that he has
29 found the elements and limitations of Applicant's invention.

30 (a) using a remote pilot to fly said unmanned aerial vehicle using synthetic vision during at
31 least selected phases of the flight of said unmanned aerial vehicle, and during those phases of
32 the flight of said unmanned aerial vehicle when said synthetic vision system is not used to

1 control said unmanned aerial vehicle an autonomous control system is used to fly said
2 unmanned aerial vehicle;

3 (b) providing a system onboard said unmanned aerial vehicle for detecting the presence and
4 position of nearby aircraft and communicating this information to said remote pilot.
5

6 The Examiner has not even attempted to show where these limitations are taught in Margolin '724.
7 He has particularly failed to show where the following is taught:

8 (a) using a remote pilot to fly said unmanned aerial vehicle using synthetic vision during at
9 least selected phases of the flight of said unmanned aerial vehicle, and during those phases of
10 the flight of said unmanned aerial vehicle when said synthetic vision system is not used to
11 control said unmanned aerial vehicle an autonomous control system is used to fly said
12 unmanned aerial vehicle;
13

14 As noted, he has cited the core of the Margolin '724 DETAILED DESCRIPTION, all of the
15 drawings, and the abstract. His rejection is purely conclusory and does not follow the requirements
16 for making a *prima facie* rejection required by MPEP § 2143.03 **All Claim Limitations Must Be**
17 **Considered**, *KSR*, and *Wehling*, as well as MPEP § 2142 **ESTABLISHING A PRIMA FACIE**
18 **CASE OF OBVIOUSNESS**.
19

20 The Examiner continues:

21 *Margolin did not disclose that the vehicle is flown using an autonomous control system.*
22 *However, Duggan teach of a system for safely flying an unmanned aerial vehicle in civilian*
23 *airspace comprising:*

24 *a ground station controlling an unmanned aerial vehicle (sec. 0352, 00353), wherein*
25 *during phases of a flight of an unmanned aerial vehicle (UAV, sec 0318, 0322, 0353) when a*
26 *synthetic vision (sec. 0356, 0365, 0388, 0390) is not used to control said unmanned aerial*
27 *vehicle said unmanned aerial vehicle is flown using an autonomous control system (autopilot,*
28 *sec 0346 to 0350, 0390-0329).*

29 *Therefore, it would have been obvious to one of ordinary skill in the art at the time the*
30 *invention was made to modify Margolin as taught by Duggan for the purpose of incorporating*
31 *an autopilot to ensure smooth transitions (Duggna abstract, sec 0014, 0085, 0086).*

1 *The different embodiments in both prior arts are combinable as it would be obvious to one having*
 2 *ordinary skill in the art.*

3

| <u>Examiner</u> | <u>Duggan</u> |
|---|---|
| <p>Margolin did not disclose that the vehicle is flown using an autonomous control system. However, Duggan teach of a system for safely flying an unmanned aerial vehicle in civilian airspace comprising: a ground station controlling an unmanned aerial vehicle (sec. 0352, 00353),</p> | <p>[0352] In one aspect of the present invention, an operator station (also referred to as the ground control station or GCS) is designed to accommodate command and control of multiple vehicles or a single vehicle by a single operator. In accordance with one embodiment, the ground control station is platform independent and implements an application program interface that provides windowing and communications interfaces (e.g., the platform is implemented in Open Source wxWindows API). The underlying operating system is illustratively masked and enables a developer to code in a high level environment.</p> <p>[0353] In one embodiment, the ground control station incorporates several specialized user interface concepts designed to effectively support a single operator tasked to control multiple vehicles. The GCS also illustratively supports manual control and sensor steering modes. In the manual control mode, the operator can assume control authority of the vehicles individually from the ground control station at any time in flight. In the sensor steering mode, a vehicle will autonomously fly in the direction the operator is manually pointing the on-board imaging sensor (e.g., operator views video output from a digital camera on a TV interface, computer screen display, etc.). A custom data link is illustratively, utilized to support a two-way transfer of data between the ground control station and the UAV's. These</p> |

| | |
|--|---|
| <p>wherein during phases of a flight of an unmanned aerial vehicle (UAV, sec 0318,</p> <p>0322,</p> <p>0353)</p> | <p>design concepts together provide a flexible, multiple vehicle control system. The details of the concepts are discussed below.</p> <p>[0318] If the pilot chooses a surveillance location outside the total FOV, then the outer loop guidance will illustratively follow a command-to-LOS mode guide law until the UAV flight path points toward the target. Once the desired staring-point comes within a minimum range threshold, the guidance automatically trips into a loiter pattern (either constant-radius or elliptical) to maintain a station with a single key-click while he/she conducts other activities. FIGS. 22A & 22B together demonstrate the surveillance-point approach scenario.</p> <p>[0322] In accordance with one aspect of the present invention, sensor-slave mode commands are generated by an autonomous line-of-sight driven function, in which the command objectives are generated by the necessities of the function rather than by an operator. For example, a function designed to command a raster-scan of a particular surveillance area, or a function designed to scan a long a roadway could be used to generate sensor slave commands. Another example is a function designed to generate line-of-sight commands for UAV-to-UAV rendezvous formation flying.</p> <p>[0353] In one embodiment, the ground control station incorporates several specialized user interface concepts designed to effectively support a single operator tasked to control multiple vehicles. The GCS also illustratively supports manual control and sensor steering modes. In the manual control mode, the operator can assume control authority of the</p> |
|--|---|

| | |
|-------------------------------------|---|
| | <p>vehicles individually from the ground control station at any time in flight. In the sensor steering mode, a vehicle will autonomously fly in the direction the operator is manually pointing the on-board imaging sensor (e.g., operator views video output from a digital camera on a TV interface, computer screen display, etc.). A custom data link is illustratively, utilized to support a two-way transfer of data between the ground control station and the UAV's. These design concepts together provide a flexible, multiple vehicle control system. The details of the concepts are discussed below.</p> |
| when a synthetic vision (sec. 0356, | [0356] a synthetic vision display |
| 0365, | [0365] The two video monitors are illustratively used to display real-time data linked camera imagery from two air vehicles having cameras (of course, fewer, more or none of the vehicles might have cameras and the number of monitor displays can be altered accordingly). In accordance with one embodiment, camera imagery is recorded on videotapes during a mission. In accordance with one embodiment, the two repeater displays are used to provide redundant views of the GUI and synthetic vision display. The laptop illustratively serves as a GUI backup in the event that the main GUI fails. |
| 0388, | [0388] In one aspect of the present invention, synthetic vision display technical approach of the present invention is based upon integrating advanced simulated visuals, originally developed for training purposes, into UAV operational systems. In accordance with one embodiment, the simulated visuals are integrated with data derived from the ground |

| | |
|---|--|
| <p>0390) is not used to control said unmanned aerial vehicle said unmanned aerial vehicle is flown using an autonomous control system</p> | <p>control station during flight to enable real-time synthetic visuals.</p> <p>[0390] In one aspect of the present invention, through GUI display 2622, an operator can maintain a variable level of control over a UAV, from fully manual to fully autonomous, with simple user-friendly inputs. For example, if an operator decides to divert a UAV to a new route, the operator has a plurality of options to select from. The following are examples of some of the options that an operator has. Those skilled in the art should recognize that this is not an exhaustive list. In one embodiment, the operator could graphically edit the existing route on mission situation display 2629 by adding a waypoint or orbit pattern in the vicinity of a desired target region. Prior to accepting the edited route, the control system evaluates the revised route against the vehicle performance capability as well as terrain obstructions. If the route is within acceptable bounds, the control system registers the modified route and maneuvers the vehicle accordingly. In another embodiment, the operator could select a park mode on selections pane 2630. After selected, the control system queues the operator to click the location of and graphical size (via a mouse) the desired orbit pattern in which the vehicle will fly while "parked" over a desired target. In another embodiment, the operator can select a manual control mode on selections pane 2630. By selecting RDC (remote directional command), for example, the control system controls the UAV into a constant altitude, heading and speed flight until the operator instructs a maneuver. While in RDC mode, the operator can either pseudo-manually direct the UAV using the control stick (e.g. joystick) or the operator can</p> |
|---|--|

(autopilot, sec 0346 to 0350,

program a fixed heading, altitude and speed using the control options provided in selections pane 2630.

[0346] In accordance with one embodiment, an exemplary translation layer implementation will now be provided. After the guidance algorithms execute, the outputs are translated to the native vehicle autopilot commands. The equations below provide example kinematic translations from the guidance acceleration commands to native vehicle autopilot commands. These equations demonstrate the principal that vehicle motion is activated through acceleration. The methods that various vehicles employ to generate acceleration are numerous (bank angle autopilot, acceleration autopilot, heading control autopilot, altitude control autopilot, etc). Since the control algorithms described herein generate acceleration commands that can be kinematically translated into any of these native autopilot commands, the guidance algorithms truly provide a generalized library of control laws that can control any vehicle through that vehicle's native atomic functions. Ubiquitous acceleration control techniques enable VACS to synthesize control commands for any vehicle, including air, ground, or sea-based.

a_v = vertical plane acceleration command
 a_h = horizontal plane acceleration command
 $\theta = \tan^{-1} \left(\frac{a_h}{a_v} \right)$ = bank angle command
 $a_T = \sqrt{a_v^2 + a_h^2}$ = total body acceleration command
 $\dot{\theta} = \frac{a_h}{V}$ = turn rate command
 $i = i - 1 + \dot{\theta} \cdot t$ = heading command
 $\dot{\theta} = \left(\frac{a_v - g}{V} \right)$ = flight path rate command
 $i = i - 1 + \dot{\theta} \cdot t$ = flight path angle command
 $h \cdot \dot{\theta} = V \sin(\theta)$ = climb rate command
 $h_i = h_{i-1} + h \cdot \dot{\theta} \cdot t$ = altitude command Eq . 57

[0347] Additional functionality that can be enabled in a

translation layer is means for discouraging or preventing an operator (e.g., the human or non-human operator interfacing the VACS architecture) from overdriving, stalling, or spinning the vehicle frame. This being said, limiting algorithms can also be employed in the guidance or autopilot functions.

[0348] X. Autopilot

[0349] As has been addressed, the present invention is not limited to, and does not require, a particular autopilot system. The control system and architecture embodiments of the present invention can be adapted to accommodate virtually any autopilot system.

[0350] For the purpose of providing an example, an illustrative suitable autopilot software system will now be described. The illustrative autopilot system incorporates a three-axis design (pitch and yaw with an attitude control loop in the roll axis) for vehicle stabilization and guidance command tracking. The autopilot software design incorporates flight control techniques, which allow vehicle control algorithms to dynamically adjust airframe stabilization parameters in real-time during flight. The flight computer is programmed directly with the airframe physical properties, so that it can automatically adjust its settings with changes in airframe configuration, aerodynamic properties, and/or flight state. This provides for a simple and versatile design, and possesses the critical flexibility needed when adjustments to the airframe configuration become necessary. The three-loop design includes angular rate feedback for stability augmentation, attitude feedback for closed-loop stiffness, and

0390-0329).

acceleration feedback for command tracking. In addition, an integral controller in the forward loop illustratively provides enhanced command tracking, low frequency disturbance rejection and an automatic trim capability.

{The Examiner may have meant 0390-0392. Otherwise the range is not credible}

[0390] In one aspect of the present invention, through GUI display 2622, an operator can maintain a variable level of control over a UAV, from fully manual to fully autonomous, with simple user-friendly inputs. For example, if an operator decides to divert a UAV to a new route, the operator has a plurality of options to select from. The following are examples of some of the options that an operator has. Those skilled in the art should recognize that this is not an exhaustive list. In one embodiment, the operator could graphically edit the existing route on mission situation display 2629 by adding a waypoint or orbit pattern in the vicinity of a desired target region. Prior to accepting the edited route, the control system evaluates the revised route against the vehicle performance capability as well as terrain obstructions. If the route is within acceptable bounds, the control system registers the modified route and maneuvers the vehicle accordingly. In another embodiment, the operator could select a park mode on selections pane 2630. After selected, the control system queues the operator to click the location of and graphical size (via a mouse) the desired orbit pattern in which the vehicle will fly while "parked" over a desired target. In another embodiment, the operator can select a manual control mode on selections pane 2630. By selecting RDC (remote directional command), for example, the control system

controls the UAV into a constant altitude, heading and speed flight until the operator instructs a maneuver. While in RDC mode, the operator can either pseudo-manually direct the UAV using the control stick (e.g. joystick) or the operator can program a fixed heading, altitude and speed using the control options provided in selections pane 2630.

[0391] The described Intelligent displays with smart variables represent an effective approach to actively displaying information for different types of vehicles. However, a problem can arise when a new vehicle is integrated into the ground control station with a completely foreign command and control interface. Under these circumstances, the ground control station is not concerned about displaying data, but is tasked to provide a command and control interface for the operator to perform the required operations. This conundrum is the motivation for another embodiment of the present invention, namely, the integration of vehicle specific panels in the ground control station.

[0392] In one embodiment, a generic vehicle class (GVC) is illustratively a software component that provides a rapid development environment API to add new vehicle classes and types to the ground control station. The GVC also illustratively serves as a software construct that allows the inclusion of multiple vehicles within the ground control station framework. One of the variables in the application is a vector of pointers to a generic vehicle class. This list is constructed by allocating new specific vehicles and returning a type case to the base generic vehicle class. When a new vehicle is integrated into the ground control station, the

generic vehicle class provides all of the virtual functions to integrate with system control components (e.g., to integrate with a map display, a communications package, PCIG imagery and/or appropriate display windows). An important object in the application framework is illustratively a pointer to the current vehicle generic class. When the user switches vehicles, this pointer is updated and all displays grab the appropriate smart variables from the pointer to the new base class. This is the mechanism by which windows immediately update to the current vehicle information whenever the user switches vehicles. The default windows use the pointer to the current vehicle to grab information. In this manner, if the user switches to a new vehicle with a different set of datalink variables, that fact is immediately apparent on the display windows.

Therefore, it would have been obvious to one of ordinary skill in the art at the time the invention was made to modify Margolin as taught by Duggan for the purpose of incorporating an autopilot to ensure smooth transitions (Duggna abstract, sec 0014, 0085, 0086).

The different embodiments in both prior arts are combinable as it would be obvious to one of ordinary skill in the art.

Abstract

Embodiments are disclosed for a vehicle control system and related sub-components that together provide an operator with a plurality of specific modes of operation, wherein various modes of operation incorporate different levels of autonomous control. Through a control user interface, an operator can move between certain modes of control even after vehicle deployment. Specialized autopilot system components and methods are employed to ensure smooth transitions between

control modes. Empowered by the multi-modal control system, an operator can even manage multiple vehicles simultaneously.

[0014] Embodiments of the present invention pertain to a hierarchical control system, user interface system, and control architecture that together incorporate a broad range of user-selectable control modes representing variable levels of autonomy and vehicle control functionality. A unified autopilot is provided to process available modes and mode transitions. An intelligence synthesizer is illustratively provided to assist in resolving functional conflicts and transitioning between control modes, although certain resolutions and transitions can be incorporated directly into the functional sub-components associated with the different control modes. In accordance with one embodiment, all modes and transitions are funneled through an acceleration-based autopilot system. Accordingly, control commands and transitions are generally reduced to an acceleration vector to be processed by a centralized autopilot system.

[0085] As will be discussed in greater detail below, the control system and architecture embodiments of the present invention essentially enable any autopilot design to support control of a vehicle in numerous control modes that are executed with switches between modes during flight. All control modes are supported even in the presence of sensor errors, such as accelerometer and gyro biases. This robustness is at least partially attributable to the fact that the closed-loop system, in all control modes, is essentially slaved to an inertial path and, hence, the sensor biases wash out in the closed loop,

assuming the biases are not so grossly large that they induce stability problems in the autopilot system. Furthermore, winds are generally not an issue in the overall control scheme in that the flight control system will regulate to the inertial path, adjusting for winds automatically in the closed loop. Given the precision afforded by inertial navigation aided by GPS technology, inertial path regulation offers a highly effective and robust UAV control approach. Generally speaking, the autopilot system functions such that winds, medium Dryden turbulence levels, sensor errors, airframe aerodynamic and mass model parameter uncertainties, servo non-linearity (slew rate limits, etc.), and various other atmospheric and noise disturbances will non have a critically negative impact on flight path regulation.

[0086] Component 408 receives commands generated by component 404 and filtered by autopilot component 406. The commands received by component 408 are executed to actually manipulate the vehicle's control surfaces. Autopilot component 406 then continues to monitor vehicle stabilization and/or command tracking, making additional commands to component 408 as necessary.

1
2 At the beginning of this subsection, the Examiner asserts, “Margolin did not disclose that the
3 vehicle is flown using an autonomous control system. However, Duggan teach of a system for
4 safely flying an unmanned aerial vehicle in civilian airspace comprising: ...”

5
6 The Examiner’s statement, “However, Duggan teach of a system for safely flying an unmanned
7 aerial vehicle in civilian airspace comprising: ...” is conclusory and is not supported by the
8 Examiner’s citations to Duggan.

9

1 In addition, none of the Duggan citations teach the limitations in Applicant's Claim 8 that either
2 synthetic vision or Duggan's Variable Autonomy System comprises the step of:

3 (a) using a remote pilot to fly said unmanned aerial vehicle using synthetic vision during at
4 least selected phases of the flight of said unmanned aerial vehicle, and during those phases of
5 the flight of said unmanned aerial vehicle when said synthetic vision system is not used to
6 control said unmanned aerial vehicle an autonomous control system is used to fly said
7 unmanned aerial vehicle;

8

9 Duggan fails to teach the limitation that his Variable Autonomy System is used during selected
10 phases of a UAV's flight and Margolin '724 fails to teach the limitation that synthetic vision is used
11 during selected phases of a UAV's flight. Therefore, the combination of Duggan and Margolin '724
12 does not read on Applicant's Claim 8.

13

14 As cited above by Applicant, MPEP 2143.03 "**All Claim Limitations must be Considered**" states:
15 "all words in a claim must be considered in judging the patentability of that claim against the prior
16 art." *In re Wilson*, 424 F.2d 1382, 1385, 165 USPQ 494, 496 (CCPA 1970)."

17

18 The Examiner has failed his duty under MPEP 2143.03 (and in view of *Wehling*) to present a *prima*
19 *facie* case of obviousness for rejecting Applicant's Claim 8.

20

21 **Examiner's Regarding Claim 9**, a claim dependent on Claim 8. Applicant has shown that Claim 8
22 is nonobvious. Therefore, under **2143.03 All Claim Limitations Must Be Considered**, Claim 9 is
23 non-obvious.

24 **2143.03 All Claim Limitations Must Be ~~**>~~Considered< [R-6]**

25 ****** "All words in a claim must be considered in judging the patentability of that claim against
26 the prior art." *In re Wilson*, 424 F.2d 1382, 1385, 165 USPQ 494, 496 (CCPA 1970). If an
27 independent claim is nonobvious under 35 U.S.C. 103, then any claim depending therefrom is
28 nonobvious. *In re Fine*, 837 F.2d 1071, 5 USPQ2d 1596 (Fed. Cir. 1988).

29

30 **Examiner's Regarding Claim 10**, a claim dependent on Claim 8. Applicant has shown that Claim
31 8 is nonobvious. Therefore, under **2143.03 All Claim Limitations Must Be Considered**, Claim 10
32 is non-obvious.

1 **2143.03 All Claim Limitations Must Be ~~**>~~Considered< [R-6]**

2 ** "All words in a claim must be considered in judging the patentability of that claim against
3 the prior art." *In re Wilson*, 424 F.2d 1382, 1385, 165 USPQ 494, 496 (CCPA 1970). If an
4 independent claim is nonobvious under 35 U.S.C. 103, then any claim depending therefrom is
5 nonobvious. *In re Fine*, 837 F.2d 1071, 5 USPQ2d 1596 (Fed. Cir. 1988).

6
7 **Examiner's Regarding Claim 11**, a claim dependent on Claim 8. Applicant has shown that Claim
8 8 is nonobvious. Therefore, under **2143.03 All Claim Limitations Must Be Considered**, Claim 11
9 is non-obvious.

10 **2143.03 All Claim Limitations Must Be ~~**>~~Considered< [R-6]**

11 ** "All words in a claim must be considered in judging the patentability of that claim against
12 the prior art." *In re Wilson*, 424 F.2d 1382, 1385, 165 USPQ 494, 496 (CCPA 1970). If an
13 independent claim is nonobvious under 35 U.S.C. 103, then any claim depending therefrom is
14 nonobvious. *In re Fine*, 837 F.2d 1071, 5 USPQ2d 1596 (Fed. Cir. 1988).

15
16 **Examiner:**

Regarding claim 12, Margolin (abstract; figs. 1-7; col. 3, lines 8-67; col. 4, lines 1-67; col. 5, lines 1-67) in view of Duggan disclose a method for safely flying an unmanned aerial vehicle as part of a unmanned aerial system equipped with a synthetic vision system in civilian airspace comprising the steps of:

- (a) using a remote pilot to fly said unmanned aerial vehicle using synthetic vision during at least selected phases of the flight of said unmanned aerial vehicle, and during those phases of the flight of said unmanned aerial vehicle when said synthetic vision system is not used to control said unmanned aerial vehicle an autonomous control system is used to fly said unmanned aerial vehicle;
- (b) providing a system onboard said unmanned aerial vehicle for detecting the presence and position of nearby aircraft and communicating this information to said remote pilot;

whereas said selected phases of the flight of said unmanned aerial vehicle comprise:

- (a) when said unmanned aerial vehicle is within a selected range of an airport or other designated location and is below a first specified altitude;

(b) when said unmanned aerial vehicle is outside said selected range of an airport or other designated location and is below a second specified altitude.

1

2 Applicant:

3 In Margolin '724: Column 3, lines 8-67; Column 4, lines 1-67; and Column 5, lines 1-67 form a
4 continuous passage from Column 3, line 8 to Column 5, line 67. This passage of approximately
5 1619 words forms the core of the Margolin '724 DETAILED DESCRIPTION. The remainder of the
6 Margolin '724 DETAILED DESCRIPTION teaches additional topics such as **Flight Control** (with
7 headings *Flight Control*, *Direct Control Non-Remotely Piloted Vehicles*, *Computer Mediated Non-*
8 *Remotely Piloted Vehicles*, *Second Order Flight Control Mode*, *First Order Flight Control Mode*
9 {See Column 6, line 19 - Column 8, line 3}, the features of a Control Panel (See Column 8, line 64
10 - Column 9, line 18}, the use of a Head-Mounted Display {See Column 9, lines 19 - 32}, the use of
11 the invention for training {See Column 9, lines 33 - 63}, and **The Database** {See Column 9, line 64
12 - Column 10, line 50.}

13

14 The Examiner cites Figures 1 - 7 in Margolin '724. These constitute all the figures in Margolin
15 '724.

16

17 The Examiner also cites the Abstract in Margolin '724. According to **608.01(b) Abstract of the**

18 Disclosure [R-7]:**19 37 CFR 1.72 Title and abstract.**

20 *****

21 (b) A brief abstract of the technical disclosure in the specification must commence on a
22 separate sheet, preferably following the claims, under the heading "Abstract" or "Abstract of
23 the Disclosure." The sheet or sheets presenting the abstract may not include other parts of the
24 application or other material. The abstract in an application filed under 35 U.S.C. 111 may not
25 exceed 150 words in length. The purpose of the abstract is to enable the United States Patent
26 and Trademark Office and the public generally to determine quickly from a cursory inspection
27 the nature and gist of the technical disclosure.<

28

29 {Emphasis added}

30

1 The popular interpretation of 608.01(b) is that the purpose of the Abstract is to provide search
2 terms. In any event, the Abstract in Margolin '724 does not say anything about civilian airspace.

3
4 The Examiner has made a conclusory statement by repeating the title of Applicant's invention
5 (leaving out the words "and method") and citing the core of the DETAILED DESCRIPTION in
6 Margolin '724.

7
8 In the remaining sections of the Examiner's rejection of Applicant's Claim 8 he asserts that he has
9 found the elements and limitations of Applicant's invention.

10
11 (a) using a remote pilot to fly said unmanned aerial vehicle using synthetic vision during at
12 least selected phases of the flight of said unmanned aerial vehicle, and during those phases of
13 the flight of said unmanned aerial vehicle when said synthetic vision system is not used
14 to control said unmanned aerial vehicle an autonomous control system is used to fly said
15 unmanned aerial vehicle;

16 (b) providing a system onboard said unmanned aerial vehicle for detecting the presence and
17 position of nearby aircraft and communicating this information to said remote pilot;

18
19 whereas said selected phases of the flight of said unmanned aerial vehicle comprise:

20 (a) when said unmanned aerial vehicle is within a selected range of an airport or other
21 designated location and is below a first specified altitude;

22 (b) when said unmanned aerial vehicle is outside said selected range of an airport or other
23 designated location and is below a second specified altitude.

24
25 The Examiner has not even attempted to show where these limitations are taught in Margolin '724.
26 He has particularly failed to show where the following is taught:

27 (a) using a remote pilot to fly said unmanned aerial vehicle using synthetic vision during at
28 least selected phases of the flight of said unmanned aerial vehicle, and during those phases of
29 the flight of said unmanned aerial vehicle when said synthetic vision system is not used
30 to control said unmanned aerial vehicle an autonomous control system is used to fly said
31 unmanned aerial vehicle;

32

1 and

2 whereas said selected phases of the flight of said unmanned aerial vehicle comprise:

3 (a) when said unmanned aerial vehicle is within a selected range of an airport or other
4 designated location and is below a first specified altitude;

5 (b) when said unmanned aerial vehicle is outside said selected range of an airport or other
6 designated location and is below a second specified altitude.

7
8 As noted, he has cited the core of the Margolin '724 DETAILED DESCRIPTION, all of the
9 drawings, and the abstract. His rejection is purely conclusory and does not follow the requirements
10 for making a *prima facie* rejection required by MPEP § 2143.03 **All Claim Limitations Must Be**
11 **Considered**, *KSR*, and *Wehling*, as well as MPEP § 2142 **ESTABLISHING A PRIMA FACIE**
12 **CASE OF OBVIOUSNESS**.

13

14 The Examiner continues:

15 *Margolin did not disclose that the vehicle is flown using an autonomous control system.*
16 *However, Duggan teach of a system for safely flying an unmanned aerial vehicle in civilian*
17 *airspace comprising:*

18 *a ground station controlling an unmanned aerial vehicle (sec. 0352, 00353), wherein*
19 *during phases of a flight of an unmanned aerial vehicle (UAV, sec 0318, 0322, 0353) when a*
20 *synthetic vision (sec. 0356, 0365, 0388, 0390) is not used to control said unmanned aerial*
21 *vehicle said unmanned aerial vehicle is flown using an autonomous control system (autopilot,*
22 *sec 0346 to 0350, 0390-0329).*

23 *Therefore, it would have been obvious to one of ordinary skill in the art at the time the*
24 *invention was made to modify Margolin as taught by Duggan for the purpose of incorporating*
25 *an autopilot to ensure smooth transitions (Duggna abstract, sec 0014, 0085, 0086).*

26 *The different embodiments in both prior arts are combinable as it would be obvious to ne*
27 *having ordinary skill in the art.*

28

| <u>Examiner</u> | <u>Duggan</u> |
|------------------------------------|--|
| Margolin did not disclose that the | [0352] In one aspect of the present invention, an operator |

| | |
|--|--|
| <p>vehicle is flown using an autonomous control system. However, Duggan teach of a system for safely flying an unmanned aerial vehicle in civilian airspace comprising: a ground station controlling an unmanned aerial vehicle (sec. 0352, 00353),</p> <p>wherein during phases of a flight of an unmanned aerial vehicle (UAV, sec 0318,</p> | <p>station (also referred to as the ground control station or GCS) is designed to accommodate command and control of multiple vehicles or a single vehicle by a single operator. In accordance with one embodiment, the ground control station is platform independent and implements an application program interface that provides windowing and communications interfaces (e.g., the platform is implemented in Open Source wxWindows API). The underlying operating system is illustratively masked and enables a developer to code in a high level environment.</p> <p>[0353] In one embodiment, the ground control station incorporates several specialized user interface concepts designed to effectively support a single operator tasked to control multiple vehicles. The GCS also illustratively supports manual control and sensor steering modes. In the manual control mode, the operator can assume control authority of the vehicles individually from the ground control station at any time in flight. In the sensor steering mode, a vehicle will autonomously fly in the direction the operator is manually pointing the on-board imaging sensor (e.g., operator views video output from a digital camera on a TV interface, computer screen display, etc.). A custom data link is illustratively, utilized to support a two-way transfer of data between the ground control station and the UAV's. These design concepts together provide a flexible, multiple vehicle control system. The details of the concepts are discussed below.</p> <p>[0318] If the pilot chooses a surveillance location outside the total FOV, then the outer loop guidance will illustratively</p> |
|--|--|

| | |
|-------|--|
| | <p>follow a command-to-LOS mode guide law until the UAV flight path points toward the target. Once the desired starting-point comes within a minimum range threshold, the guidance automatically trips into a loiter pattern (either constant-radius or elliptical) to maintain a station with a single key-click while he/she conducts other activities. FIGS. 22A & 22B together demonstrate the surveillance-point approach scenario.</p> |
| 0322, | <p>[0322] In accordance with one aspect of the present invention, sensor-slave mode commands are generated by an autonomous line-of-sight driven function, in which the command objectives are generated by the necessities of the function rather than by an operator. For example, a function designed to command a raster-scan of a particular surveillance area, or a function designed to scan a long a roadway could be used to generate sensor slave commands. Another example is a function designed to generate line-of-sight commands for UAV-to-UAV rendezvous formation flying.</p> |
| 0353) | <p>[0353] In one embodiment, the ground control station incorporates several specialized user interface concepts designed to effectively support a single operator tasked to control multiple vehicles. The GCS also illustratively supports manual control and sensor steering modes. In the manual control mode, the operator can assume control authority of the vehicles individually from the ground control station at any time in flight. In the sensor steering mode, a vehicle will autonomously fly in the direction the operator is manually pointing the on-board imaging sensor (e.g., operator views video output from a digital camera on a TV interface, computer screen display, etc.). A custom data link is</p> |

| | |
|---|---|
| <p>when a synthetic vision (sec. 0356,</p> <p>0365,</p> <p>0388,</p> <p>0390) is not used to control said unmanned aerial vehicle said unmanned aerial vehicle is flown</p> | <p>illustratively, utilized to support a two-way transfer of data between the ground control station and the UAV's. These design concepts together provide a flexible, multiple vehicle control system. The details of the concepts are discussed below.</p> <p>[0356] a synthetic vision display</p> <p>[0365] The two video monitors are illustratively used to display real-time data linked camera imagery from two air vehicles having cameras (of course, fewer, more or none of the vehicles might have cameras and the number of monitor displays can be altered accordingly). In accordance with one embodiment, camera imagery is recorded on videotapes during a mission. In accordance with one embodiment, the two repeater displays are used to provide redundant views of the GUI and synthetic vision display. The laptop illustratively serves as a GUI backup in the event that the main GUI fails.</p> <p>[0388] In one aspect of the present invention, synthetic vision display technical approach of the present invention is based upon integrating advanced simulated visuals, originally developed for training purposes, into UAV operational systems. In accordance with one embodiment, the simulated visuals are integrated with data derived from the ground control station during flight to enable real-time synthetic visuals.</p> <p>[0390] In one aspect of the present invention, through GUI display 2622, an operator can maintain a variable level of control over a UAV, from fully manual to fully autonomous,</p> |
|---|---|

| | |
|--|---|
| <p>using an autonomous control system</p> <p>(autopilot, sec 0346 to 0350,</p> | <p>with simple user-friendly inputs. For example, if an operator decides to divert a UAV to a new route, the operator has a plurality of options to select from. The following are examples of some of the options that an operator has. Those skilled in the art should recognize that this is not an exhaustive list. In one embodiment, the operator could graphically edit the existing route on mission situation display 2629 by adding a waypoint or orbit pattern in the vicinity of a desired target region. Prior to accepting the edited route, the control system evaluates the revised route against the vehicle performance capability as well as terrain obstructions. If the route is within acceptable bounds, the control system registers the modified route and maneuvers the vehicle accordingly. In another embodiment, the operator could select a park mode on selections pane 2630. After selected, the control system queues the operator to click the location of and graphical size (via a mouse) the desired orbit pattern in which the vehicle will fly while "parked" over a desired target. In another embodiment, the operator can select a manual control mode on selections pane 2630. By selecting RDC (remote directional command), for example, the control system controls the UAV into a constant altitude, heading and speed flight until the operator instructs a maneuver. While in RDC mode, the operator can either pseudo-manually direct the UAV using the control stick (e.g. joystick) or the operator can program a fixed heading, altitude and speed using the control options provided in selections pane 2630.</p> <p>[0346] In accordance with one embodiment, an exemplary translation layer implementation will now be provided. After the guidance algorithms execute, the outputs are translated to</p> |
|--|---|

the native vehicle autopilot commands. The equations below provide example kinematic translations from the guidance acceleration commands to native vehicle autopilot commands. These equations demonstrate the principal that vehicle motion is activated through acceleration. The methods that various vehicles employ to generate acceleration are numerous (bank angle autopilot, acceleration autopilot, heading control autopilot, altitude control autopilot, etc). Since the control algorithms described herein generate acceleration commands that can be kinematically translated into any of these native autopilot commands, the guidance algorithms truly provide a generalized library of control laws that can control any vehicle through that vehicle's native atomic functions. Ubiquitous acceleration control techniques enable VACS to synthesize control commands for any vehicle, including air, ground, or sea-based.

a_v = vertical plane acceleration command
 a_h = horizontal plane acceleration command
 $\theta = \tan^{-1} (a_h / a_v)$ = bank angle command
 $a_T = \sqrt{a_v^2 + a_h^2}$ = total body acceleration command
 $\dot{\theta} = a_h / V$ = turn rate command
 $i = i - 1 + \dot{\theta} \cdot t$ = heading command
 $\dot{\theta} = (a_v - g) / V$ = flight path rate command
 $i = i - 1 + \dot{\theta} \cdot t$ = flight path angle command
 $h \cdot = V \sin(\theta)$ = climb rate command
 $\dot{h} = h \cdot = 1 + h \cdot \cdot t$ = altitude command Eq . 57

[0347] Additional functionality that can be enabled in a translation layer is means for discouraging or preventing an operator (e.g., the human or non-human operator interfacing the VACS architecture) from overdriving, stalling, or spinning the vehicle frame. This being said, limiting algorithms can also be employed in the guidance or autopilot functions.

[0348] X. Autopilot

[0349] As has been addressed, the present invention is not limited to, and does not require, a particular autopilot system. The control system and architecture embodiments of the present invention can be adapted to accommodate virtually any autopilot system.

[0350] For the purpose of providing an example, an illustrative suitable autopilot software system will now be described. The illustrative autopilot system incorporates a three-axis design (pitch and yaw with an attitude control loop in the roll axis) for vehicle stabilization and guidance command tracking. The autopilot software design incorporates flight control techniques, which allow vehicle control algorithms to dynamically adjust airframe stabilization parameters in real-time during flight. The flight computer is programmed directly with the airframe physical properties, so that it can automatically adjust its settings with changes in airframe configuration, aerodynamic properties, and/or flight state. This provides for a simple and versatile design, and possesses the critical flexibility needed when adjustments to the airframe configuration become necessary. The three-loop design includes angular rate feedback for stability augmentation, attitude feedback for closed-loop stiffness, and acceleration feedback for command tracking. In addition, an integral controller in the forward loop illustratively provides enhanced command tracking, low frequency disturbance rejection and an automatic trim capability.

0390-0329).

{The Examiner may have meant 0390-0392. Otherwise the

range is not credible}

[0390] In one aspect of the present invention, through GUI display 2622, an operator can maintain a variable level of control over a UAV, from fully manual to fully autonomous, with simple user-friendly inputs. For example, if an operator decides to divert a UAV to a new route, the operator has a plurality of options to select from. The following are examples of some of the options that an operator has. Those skilled in the art should recognize that this is not an exhaustive list. In one embodiment, the operator could graphically edit the existing route on mission situation display 2629 by adding a waypoint or orbit pattern in the vicinity of a desired target region. Prior to accepting the edited route, the control system evaluates the revised route against the vehicle performance capability as well as terrain obstructions. If the route is within acceptable bounds, the control system registers the modified route and maneuvers the vehicle accordingly. In another embodiment, the operator could select a park mode on selections pane 2630. After selected, the control system queues the operator to click the location of and graphical size (via a mouse) the desired orbit pattern in which the vehicle will fly while "parked" over a desired target. In another embodiment, the operator can select a manual control mode on selections pane 2630. By selecting RDC (remote directional command), for example, the control system controls the UAV into a constant altitude, heading and speed flight until the operator instructs a maneuver. While in RDC mode, the operator can either pseudo-manually direct the UAV using the control stick (e.g. joystick) or the operator can program a fixed heading, altitude and speed using the control options provided in selections pane 2630.

[0391] The described Intelligent displays with smart variables represent an effective approach to actively displaying information for different types of vehicles. However, a problem can arise when a new vehicle is integrated into the ground control station with a completely foreign command and control interface. Under these circumstances, the ground control station is not concerned about displaying data, but is tasked to provide a command and control interface for the operator to perform the required operations. This conundrum is the motivation for another embodiment of the present invention, namely, the integration of vehicle specific panels in the ground control station.

[0392] In one embodiment, a generic vehicle class (GVC) is illustratively a software component that provides a rapid development environment API to add new vehicle classes and types to the ground control station. The GVC also illustratively serves as a software construct that allows the inclusion of multiple vehicles within the ground control station framework. One of the variables in the application is a vector of pointers to a generic vehicle class. This list is constructed by allocating new specific vehicles and returning a type case to the base generic vehicle class. When a new vehicle is integrated into the ground control station, the generic vehicle class provides all of the virtual functions to integrate with system control components (e.g., to integrate with a map display, a communications package, PCIG imagery and/or appropriate display windows). An important object in the application framework is illustratively a pointer to the current vehicle generic class. When the user switches vehicles, this pointer is updated and all displays grab the

| | |
|---|---|
| <p>Therefore, it would have been obvious to one of ordinary skill in the art at the time the invention was made to modify Margolin as taught by Duggan for the purpose of incorporating an autopilot to ensure smooth transitions (Duggna abstract, sec 0014, 0085, 0086).</p> <p>The different embodiments in both prior arts are combinable as it would be obvious to ne[sic] having ordinary skill in the art.</p> | <p>appropriate smart variables from the pointer to the new base class. This is the mechanism by which windows immediately update to the current vehicle information whenever the user switches vehicles. The default windows use the pointer to the current vehicle to grab information. In this manner, if the user switches to a new vehicle with a different set of datalink variables, that fact is immediately apparent on the display windows.</p> <p>Abstract</p> <p>Embodiments are disclosed for a vehicle control system and related sub-components that together provide an operator with a plurality of specific modes of operation, wherein various modes of operation incorporate different levels of autonomous control. Through a control user interface, an operator can move between certain modes of control even after vehicle deployment. Specialized autopilot system components and methods are employed to ensure smooth transitions between control modes. Empowered by the multi-modal control system, an operator can even manage multiple vehicles simultaneously.</p> <p>[0014] Embodiments of the present invention pertain to a hierarchical control system, user interface system, and control architecture that together incorporate a broad range of user-</p> |
|---|---|

selectable control modes representing variable levels of autonomy and vehicle control functionality. A unified autopilot is provided to process available modes and mode transitions. An intelligence synthesizer is illustratively provided to assist in resolving functional conflicts and transitioning between control modes, although certain resolutions and transitions can be incorporated directly into the functional sub-components associated with the different control modes. In accordance with one embodiment, all modes and transitions are funneled through an acceleration-based autopilot system. Accordingly, control commands and transitions are generally reduced to an acceleration vector to be processed by a centralized autopilot system.

[0085] As will be discussed in greater detail below, the control system and architecture embodiments of the present invention essentially enable any autopilot design to support control of a vehicle in numerous control modes that are executed with switches between modes during flight. All control modes are supported even in the presence of sensor errors, such as accelerometer and gyro biases. This robustness is at least partially attributable to the fact that the closed-loop system, in all control modes, is essentially slaved to an inertial path and, hence, the sensor biases wash out in the closed loop, assuming the biases are not so grossly large that they induce stability problems in the autopilot system. Furthermore, winds are generally not an issue in the overall control scheme in that the flight control system will regulate to the inertial path, adjusting for winds automatically in the closed loop. Given the precision afforded by inertial navigation aided by GPS technology, inertial path regulation offers a highly effective

and robust UAV control approach. Generally speaking, the autopilot system functions such that winds, medium Dryden turbulence levels, sensor errors, airframe aerodynamic and mass model parameter uncertainties, servo non-linearity (slew rate limits, etc.), and various other atmospheric and noise disturbances will non have a critically negative impact on flight path regulation.

[0086] Component 408 receives commands generated by component 404 and filtered by autopilot component 406. The commands received by component 408 are executed to actually manipulate the vehicle's control surfaces. Autopilot component 406 then continues to monitor vehicle stabilization and/or command tracking, making additional commands to component 408 as necessary.

1

2

3 At the beginning of this subsection, the Examiner asserts, “Margolin did not disclose that the
4 vehicle is flown using an autonomous control system. However, Duggan teach of a system for
5 safely flying an unmanned aerial vehicle in civilian airspace comprising: ...”

6

7 The Examiner’s statement, “However, Duggan teach of a system for safely flying an unmanned
8 aerial vehicle in civilian airspace comprising: ...” is conclusory and is not supported by the
9 Examiner’s citations to Duggan.

10

11 In addition, none of the Duggan citations teach the limitations in Applicant’s Claim 12 that either
12 synthetic vision or Duggan’s Variable Autonomy System comprises the step of:

13 (a) using a remote pilot to fly said unmanned aerial vehicle using synthetic vision during at
14 least selected phases of the flight of said unmanned aerial vehicle, and during those phases of
15 the flight of said unmanned aerial vehicle when said synthetic vision system is not used to
16 control said unmanned aerial vehicle an autonomous control system is used to fly said
17 unmanned aerial vehicle;

18 and

1 whereas said selected phases of the flight of said unmanned aerial vehicle comprise:

2 (a) when said unmanned aerial vehicle is within a selected range of an airport or other
3 designated location and is below a first specified altitude;

4 (b) when said unmanned aerial vehicle is outside said selected range of an airport or other
5 designated location and is below a second specified altitude.
6

7 Duggan fails to teach the limitation that his Variable Autonomy System is used during selected
8 phases of a UAV's flight and Margolin '724 fails to teach the limitation that synthetic vision is used
9 during selected phases of a UAV's flight. Therefore, the combination of Duggan and Margolin '724
10 does not read on Applicant's Claim 12.
11

12 As cited above by Applicant, MPEP 2143.03 "**All Claim Limitations must be Considered**" states:
13 "all words in a claim must be considered in judging the patentability of that claim against the prior
14 art." *In re Wilson*, 424 F.2d 1382, 1385, 165 USPQ 494, 496 (CCPA 1970)."
15

16 The Examiner has failed his duty under MPEP 2143.03 (and in view of *Wehling*) to present a *prima*
17 *facie* case of obviousness for rejecting Applicant's Claim 12.
18

19 **Examiner's Regarding Claim 13**, a claim dependent on Claim 12. Applicant has shown that Claim
20 12 is nonobvious. Therefore, under **2143.03 All Claim Limitations Must Be Considered**, Claim
21 13 is non-obvious.

22 **2143.03 All Claim Limitations Must Be ~~**>~~Considered< [R-6]**

23 ** "All words in a claim must be considered in judging the patentability of that claim against
24 the prior art." *In re Wilson*, 424 F.2d 1382, 1385, 165 USPQ 494, 496 (CCPA 1970). If an
25 independent claim is nonobvious under 35 U.S.C. 103, then any claim depending therefrom is
26 nonobvious. *In re Fine*, 837 F.2d 1071, 5 USPQ2d 1596 (Fed. Cir. 1988).
27

28 **Examiner's Regarding Claim 14**, a claim dependent on Claim 12. Applicant has shown that Claim
29 12 is nonobvious. Therefore, under **2143.03 All Claim Limitations Must Be Considered**, Claim
30 14 is non-obvious.

31 **2143.03 All Claim Limitations Must Be ~~**>~~Considered< [R-6]**

1 ** "All words in a claim must be considered in judging the patentability of that claim against
2 the prior art." *In re Wilson*, 424 F.2d 1382, 1385, 165 USPQ 494, 496 (CCPA 1970). If an
3 independent claim is nonobvious under 35 U.S.C. 103, then any claim depending therefrom is
4 nonobvious. *In re Fine*, 837 F.2d 1071, 5 USPQ2d 1596 (Fed. Cir. 1988).

5
6 **Part B - The Present Applicant is the named inventor on 5,904,724.**

7 The present Applicant (Jed Margolin) is the named inventor on U.S. Patent 5,904,724. See the
8 attached DECLARATION OF JED MARGOLIN. The Examiner is barred from citing '724 as prior
9 art in a 35 U.S.C. §103 rejection. *See ISCO INTERN v. Conductus, Inc*, 279 F.Supp.2d 489 (D.Del.
10 2003) Footnote 4:

11 [4] Although § 102 relates to prior invention by another, anticipation, and abandonment, its
12 standard for determining prior art is applied to the § 103 obviousness inquiry as well. *See, e.g.,*
13 *Panduit Corp. v. Dennison Mfg. Co.*, 810 F.2d 1561, 1568 (Fed.Cir.1987), *cert. denied*, 481
14 U.S. 1052, 107 S.Ct. 2187, 95 L.Ed.2d 843 (1987) ("Before answering *Graham's* `content'
15 inquiry, it must be known whether a patent or publication is in the prior art under 35 U.S.C. §
16 102.") (citing *Graham v. John Deere Co.*, 383 U.S. 1, 86 S.Ct. 684, 15 L.Ed.2d 545 (1966)); *Ex*
17 *parte Andresen*, 212 U.S.P.Q. 100, 102 (Pat.& Tr. Office Bd.App. 1981) (citing congressional
18 committee record and commentary and concluding that Congress intended § 103 to "includ[e]
19 all of the various bars to a patent as set forth in section 102").

20
21 As MPEP 2129 explains, "However, even if labeled as "prior art," the work of the same inventive
22 entity may not be considered prior art against the claims unless it falls under one of the statutory
23 categories."

24 **2129 Admissions as Prior Art [R-6]**

25 **I. ADMISSIONS BY APPLICANT CONSTITUTE PRIOR ART**

26 A statement by an applicant >in the specification or made< during prosecution identifying the
27 work of another as "prior art" is an admission **>which can be relied upon for both
28 anticipation and obviousness determinations, regardless of whether the admitted prior art would

1 otherwise qualify as prior art under the statutory categories of 35 U.S.C. 102. *Riverwood Int'l*
2 *Corp. v. R.A. Jones & Co.*, 324 F.3d 1346, 1354, 66 USPQ2d 1331, 1337 (Fed. Cir. 2003);
3 *Constant v. Advanced Micro-Devices Inc.*, 848 F.2d 1560, 1570, 7 USPQ2d 1057, 1063 (Fed.
4 Cir. 1988).< However, even if labeled as "prior art," the work of the same inventive entity may
5 not be considered prior art against the claims unless it falls under one of the statutory
6 categories. *Id.*; see also *Reading & Bates Construction Co. v. Baker Energy Resources Corp.*,
7 748 F.2d 645, 650, 223 USPQ 1168, 1172 (Fed. Cir. 1984) ("[W]here the inventor continues to
8 improve upon his own work product, his foundational work product should not, without a
9 statutory basis, be treated as prior art solely because he admits knowledge of his own work. It is
10 common sense that an inventor, regardless of an admission, has knowledge of his own work.").

11 Consequently, the examiner must determine whether the subject matter identified as "prior art"
12 is applicant's own work, or the work of another. In the absence of another credible explanation,
13 examiners should treat such subject matter as the work of another.

14
15 **Part D - Applicant's invention meets a long felt but unmet need.**

16 According to the article **NASA Plans UAS Push** (Exhibit 1 at 81):

17 NASA is seeking industry feedback on its plans for a new five-year, \$150-million program to
18 help integrate unmanned aircraft into civil airspace. The feedback is likely to be mixed, as the
19 agency's last major unmanned aircraft research program was canceled before it got off the
20 ground, despite industry backing.

21
22 Briefed to industry experts in early August, the Unmanned Air Systems (UAS) Integration in
23 the National Airspace System (NAS) project is planned to begin in Fiscal 2011. It would be
24 NASA's first major unmanned aircraft effort since the High-Altitude Long-Endurance Remotely
25 Operated Aircraft (HALE ROA) project was killed in 2005.

26
27 The new program would focus on separation assurance and collision avoidance, pilot-aircraft
28 interface, certification requirements and communications, involving a series of increasingly
29 complex flight demonstrations. The main goal is to generate data to help the FAA and

1 standards organizations develop guidelines and regulations for the design and operation of
2 UASs in the NAS. The research is expected to have an impact in the 2015-25 timeframe.

3
4 Applicant's invention solves a long-felt unmet need to safely fly UAVs in civilian airspace. (See
5 MPEP 716.04 **Long-Felt Need and Failure of Others.**) Otherwise it would not be necessary for
6 NASA to set up "a new five-year, \$150-million program to help integrate unmanned aircraft into
7 civilian airspace."

8
9 **Part E - The Duggan Application.**

10 The Examiner's choice of Duggan Patent Application US 2005004723 as a reference is interesting.
11 By a coincidence Applicant ("Margolin") discovered the Duggan Application not long after the
12 USPTO published it.

13
14 Margolin analyzed the Dugan claims and found some deficiencies. For example, Duggan Claim 1:

15
16 1. A computer-implemented method for providing an operator of a vehicle with a plurality of
17 control modes, wherein the system is configured to support transitioning between control
18 modes during operation of the vehicle, the method comprising: receiving a first operator input
19 that corresponds to a first control mode; generating a first directional representation of the first
20 operator input; processing the first directional representation through a unified autopilot system
21 so as to generate a first control output; mechanically adjusting a control component associated
22 with the vehicle based on the first control output; receiving a second operator input that
23 corresponds to a request to transition from the first control mode to a second control mode;
24 transitioning from the first control mode to the second control mode; receiving a third operator
25 input that corresponds to the second control mode; generating a second directional
26 representation of the third operator input; processing the second directional representation
27 through the unified autopilot system so as to generate a second control output; and
28 mechanically adjusting a control component associated with the vehicle based on the second
29 control output.

30 {Emphasis added}

1 This claims a method where the operator of a vehicle is able to select two or more control modes
2 and the system transitions between them. The claim does not say how the system transitions
3 between them other than that the autopilot does it. The term “directional representation” does not
4 appear in the Specification. What is the “directional representation” of an operator input? Common
5 English usage suggests that it is the line or course along which the operator moves the joystick or
6 mouse. Also, by definition an autopilot mechanically adjusts control components so this part of the
7 claim is redundant.

8
9 Duggan’s Dependent claim 2 is redundant. Duggan’s Claim 1 already specifies the use of a unified
10 autopilot.

11 2. The method of claim 1, wherein said transitioning comprises processing a transition
12 command through the unified autopilot system.

13

14 Duggan Dependent claim 3:

15 3. The method of claim 1, wherein generating a first directional representation comprises
16 generating a first set of acceleration and bank angle commands.

17

18 Finally, something real. A directional representation can be a set of acceleration and bank angle
19 commands. What else can a “directional representation” be? Duggan does not teach it, so Claim 1 is
20 indistinct.

21

22 Even so, this may have already been done. For example see U.S. Patent 4,155,525 **Maneuver**
23 **detector circuit for use in autothrottle control systems having thrust and flight path control**
24 **decoupling** issued May 22, 1979 to Peter-Contesse (assigned to Boeing). From Column 1, lines 15-
25 28:

26 It is an object of this invention to provide a flight control system having thrust and flight path
27 control decoupling utilizing maneuver detector and limited integrator circuit means in lieu of
28 the aforementioned time-constant programmer circuit means.

29

30 It is yet another object of this invention to provide circuit means responsive to elevator, normal
31 acceleration, and pitch attitude signals for providing a signal having a first predetermined
32 polarity when a purposeful maneuver of the aircraft is effected and a further signal having a
33 polarity opposite to said first predetermined polarity when a non-maneuver is indicated, a

1 purposeful maneuver being defined as one initiated by the pilot as contrasted to non-pilot
2 initiated aircraft maneuvers.

3
4 There is also U.S. Patent 6,062,513 **Total energy based flight control system** issued May 16, 2000
5 to Lambregts (also assigned to Boeing). From Column 6, line 65 - Column 7, line 14:

6 The present invention modifies the known TEC system by using an alternate control strategy
7 and flight path command γ processing scheme. This alternate strategy is used
8 during manual control mode (using a control column or the like) when the thrust has been
9 driven to a preset value (such as a maximum or minimum thrust limit) or when the automatic
10 throttle is disengaged. Under these circumstances, instead of reverting to a pure path priority
11 scheme for stick or control column inputs (by opening switch 30 and letting the airspeed
12 increase or decreases until a speed limit is reached as is done in the known TEC system), the
13 present invention transitions to a combined speed and path priority scheme, where flight path
14 angle is the short term control priority and the set speed command is the long term priority. In
15 this scheme, switch 30' remains closed and the normal speed control feedback is continued after
16 thrust reaches a limit.

17
18 Duggan Claim 31:

19 31. A multi-modal variable autonomy control system, the system comprising:

20
21 a plurality of control mode components each corresponding to a different mode of control and
22 being configured to respond to command inputs by generating directionally descriptive control
23 commands; and

24
25 a unified autopilot component for processing said directionally descriptive control commands.

26
27 an vehicle control component for receiving processed commands from the unified autopilot
28 system and actuating control devices accordingly.

29
30 This claim contains inexcusable punctuation errors. These errors were not introduced by the Patent
31 Office; they are in the Application in the File Wrapper. See Exhibit 2 at 83.

32

1 Margolin gave his analysis to Optima Technology, Inc. (now Optima Technology Group) who was
2 then acting as Margolin's agent for selling or licensing his patents. Optima contacted Geneva
3 Aerospace, the assignee of the Duggan application.

4
5 Geneva responded by filing a Supplemental IDS listing all of Margolin's patents (even though only
6 5,566,073 and 5,904,724 were relevant), U.S. Patents 4,155,525 and 6,062,513, along with some of
7 the non-patent literature that Margolin had presented, such as:

8
9 **Beringer, D.; Applying Performance-Controlled Systems, Fuzzy Logic, and Fly-By-Wire**
10 **Controls to General Aviation**, Office of Aerospace Medicine, May 2002.

11
12 **Abernathy, M.; "Virtual Cockpit Window" for a Windowless Aerospacecraft.**
13 <http://www.nasatech.com/Briefs/Jan03/MSC23096.html> Jan. 2003.

14
15 See Exhibit 2 at 84-88.

16
17 **Geneva also licensed Margolin Patents 5,566,073 and 5,904,724.** See Exhibit 3 at 91.

18
19 It came as a complete surprise to Applicant when the Duggan Application was allowed as filed
20 (despite its defects) in the FOAM. Geneva's attorneys may have been surprised as well. They had to
21 ask the Duggan Examiner to correct the punctuation errors in Duggan Claim 31. See Exhibit 2 at 89.

22
23 Perhaps the Duggan Examiner was preoccupied with financial problems. See Exhibit 4 at 109. But
24 where were the Second Set of Eyes? Perhaps they were sleeping that day.

25
26 Margolin wishes to note that the Examiner in the present case cited the Duggan Application even
27 though it had already issued as U.S. Patent 7,343,232 ('232) **Vehicle control system including**
28 **related methods and components** on March 11, 2008.

29
30 The Duggan Application may have other problems as well. The Duggan Application claims priority
31 from Provisional Application Ser. No. 60/480,192, filed Jun. 20, 2003. According to 35 U.S.C. 102
32 **Conditions for patentability; novelty and loss of right to patent.**

33 A person shall be entitled to a patent unless -

34 *****

1 (b) the invention was patented or described in a printed publication in this or a foreign country
2 or in public use or on sale in this country, more than one year prior to the date of application for
3 patent in the United States.
4

5 There is evidence that this might have occurred. The paper **UCAV Distributed Mission Training**
6 **Testbed: Lessons Learned and Future Challenges** by Dr. Dutch Guckenberger and Matt Archer;
7 The Interservice/Industry Training, Simulation & Education Conference (I/ITSEC), Volume: 2000
8 (Conference Theme: Partnerships for Learning in the New Millennium) was presented at the
9 I/ITSEC Conference in 2000. The title page and page 7 are reproduced in Exhibit 5 at 180. On
10 document page 7 (Exhibit 5 at 183), under the heading **Variable Autonomy Control System**
11 **(VACS)** it refers to Geneva Aerospace's Variable Autonomy Control System:

12
13 As a portion of the DMT UCAV Testbed development, the **Geneva AeroSpace Variable**
14 **Autonomy Control System (VACS) was added to LiteFlite. The VACS is designed to be**
15 **effective for UAV and UCAV systems as usable to individuals whose training is focused**
16 **on the requirements of a given mission or the usability of the payload, rather than on the**
17 **aviation of the vehicle.** As the dependence on UAVs for military operations grows and UAV
18 technology is integrated into the emerging global command and control architecture, the cost
19 and complexity of managing and controlling these assets can easily become substantial. The
20 VACS solution to this UAV control problem lies in the appropriate functional allocation
21 between the human and the machine. By merging modern stand-off missile flight control,
22 advanced aircraft flight control, and state-of-the-art communications technologies, **Geneva has**
23 **developed a novel hierarchical flight control structure with varied levels of remote**
24 **operator input to address the human-machine functional allocation problem.**

25
26 **The VACS has been successfully demonstrated enabling a diverse range of users to**
27 **effectively operate UAVs.** Furthermore, the VACS solution eliminates the requirement for
28 UAVs to be controlled by highly trained, rated pilots. In a continuing development and
29 demonstration effort VACS is to be used Joint STARS MTE workstation and the Freewing
30 Scorpion 100-50 UAV and conduct a flight test demonstration. This program will demonstrate
31 the benefits of the variable autonomy flight control system design with simplified manual
32 control modes, demonstrate the compatibility of such a system with the military's emerging C4I

1 architecture, and demonstrate the synergism between Joint STARS and UAVs using the
2 simplified UAV flight control technology.

3
4 {Emphasis added}

5
6 Geneva Aerospace filed a trademark application with the USPTO on 1/22/2004 for the trademark
7 “Variable Autonomy Control System.” See Exhibit 6 at 185. In the application Geneva Aerospace
8 declared, under penalty of perjury:

9
10 The applicant, or the applicant's related company or licensee, is using the mark in commerce,
11 and lists below the dates of use by the applicant, or the applicant's related company, licensee, or
12 predecessor in interest, of the mark on or in connection with the identified goods and/or
13 services. 15 U.S.C. Section 1051(a), as amended.

14
15 International Class 009: computer software for autonomous aerial vehicle guidance and
16 control systems

17
18 In International Class 009, the mark was first used at least as early as 09/01/1998, **and first**
19 **used in commerce at least as early as 09/01/1998**, and is now in use in such commerce. The
20 applicant is submitting or will submit one specimen for each class showing the mark as used in
21 commerce on or in connection with any item in the class of listed goods and/or services,
22 consisting of a(n) Portion of company website describing product.

23
24 {Emphasis added}

25
26 The mark “Variable Autonomy Control System” is for “computer software for autonomous aerial
27 vehicle guidance and control systems”.

28
29 Geneva declares that the “Variable Autonomy Control System” was first used in commerce as early
30 as 09/01/1998, which is more than one year prior to the 6/20/2003 filing date of the provisional
31 application.

32

1 Is the “Variable Autonomy Control System” in the Duggan ‘232 patent the same “Variable
2 Autonomy Control System” that Geneva wished to trademark? Their trademark application
3 included a portion of the company website describing the product, which states (Exhibit 6 at 188):

4
5 **Products: Variable Autonomy Control System (VACS)TM**

6
7 **Under Air Force Research Lab funding** Geneva has developed an innovative UAV control
8 design that combines state-of-the-art missile technologies with fixed-wing aircraft control. Our
9 design balances autonomous flight control **With manual control to provide variable levels of**
10 **directional independence** and minimizes the personnel and training requirements for the
11 operation of the UAV, The truly enabled UAV operator is not required to be a trained aviator,
12 but still retains a wide range of control flexibility in order to successfully execute the mission
13 objectives that call upon his/her specialized expertise.

14
15 **Our solution is a hierarchical flight control structure with multiple levels of remote**
16 **operator input combined with an off-board controller software package and intuitive**
17 **human system interface.** Research of the UAV control problem has indicated that the best
18 solution lies in the appropriate functional allocation between the human and the machine,
19 leading to the organization of the control problem between the two fundamental categories:
20 flight governance and flight management.

21
22 {Emphasis added}

23
24 It sounds like it is.

25
26 Therefore, the Duggan ‘232 patent is invalid for failing to meet the requirements of 35 U.S.C 102.

27
28 Note that the Duggan “Variable Autonomy Control System” was developed under Air Force
29 Research Lab funding. That would give the Government certain patent rights in the invention. This
30 is not stated in the Duggan ‘232 patent.

31
32 Geneva also filed an application to trademark “VCAS”. They made the same declaration as they did
33 for “Variable Autonomy Control System” and included the same company website page. See
34 Exhibit 7 at 190.

35

1 Dave Duggan of Geneva Aerospace and Luis A. Piñeiro of AFRL presented a paper at the 2002
2 AUVSI Symposium. The paper from the Proceedings is reproduced as Exhibit 8 at 195. From
3 Exhibit 8 at 196, last paragraph under the heading **VACS Overview**:

4
5 Funding for the variable autonomy control concept was provided under the Small Business
6 Innovative Research (SBIR) program Phase I, Phase II, and Phase III funding vehicles through
7 the Air Force Research Laboratory (AFRL) Human Effectiveness and Air Vehicles Integration
8 Directorates (Reference 1).

9
10 Reference 1 says:

11 1. Duggan, David S., "Demonstration of an Integrated Variable Autonomy UAV Flight
12 Control System", Phase II SBIR Final Report, AFRL-HE-WP-TR-2001-0035, January 2001

13

14 Applicant has not been able to obtain this reference from DTIC.

15

16 However, Duggan/Geneva Aerospace's Provisional Application (Application Number 60/480,192)
17 contains Geneva Aerospace's **Small Business Innovation Research (SBIR) Program Projects**
18 **Summary**, Topic Number AF98-179 (Exhibit 9 at 211), which shows that Geneva Aerospace had
19 the invention described in '232 in its possession as early as the date the SBIR Project Summary for
20 AF98-179 was submitted. According to the Air Force SBIR Web site at
21 <http://www.afsbirsttr.com/TechMall/Default.aspx?kwa=AF98-179> the SBIR Phase I Contract
22 started 5/14/1998, ended 2/14/1999, and the date of the DTIC report is 3/20/2001. See Exhibit 10 at
23 235.

24

25 This suggests that Geneva Aerospace was being truthful in their Trademark Applications, that the
26 products named Variable Autonomy Control Systems and VACS were first used commercially as
27 early as 09/01/1998.

28

29 The '232 patent claims priority from Provisional Application 60/480,192 filed June 20, 2003 and
30 incorporates the Provisional Application in its entirety in the '232 patent. See '232 Column 1, lines
31 6 - 9. However, Provisional Application 60/480,192 was not made available to the public on PAIR
32 until November 22, 2010. See Margolin Declaration § 14. As a result, the public was not able to
33 read the entire '232 patent until November 22, 2010.

1

2 The Duggan Provisional Application contains an Information Disclosure Statement (PTO-1449),
3 filed July 29, 2004 listing a number of patent references. See Exhibit 11 at 237. With the exception
4 of U.S. Patent 5,904,724 none of the other patent references are listed on the '232 patent. And, with
5 the exception of 5,904,724 none of the references cited by Duggan in his Provisional Application
6 are marked as having been considered by the Duggan Examiner.

7

8 The irregularities surrounding the '232 patent would call for an investigation by the USPTO's
9 Inspector General, but the USPTO does not seem to have an Inspector General.

10

11

Section 3.

12

13 For the foregoing reasons, Applicant submits that all objections and rejections have been overcome.
14 Applicant requests that the rejection of pending claims 1-14 be withdrawn and that the application
15 be allowed as filed.

16

17 Respectfully submitted,

18

19 /Jed Margolin/ Date: November 29, 2010

20 Jed Margolin

21

22

23 Jed Margolin

24 1981 Empire Rd.

25 Reno, NV 89521-7430

26 (775) 847-7845

27

28

29

1 **IN THE UNITED STATES PATENT AND TRADEMARK OFFICE**

2

3 In re Application of Jed Margolin

4 Serial No.: 11/736,356

Examiner: Ronnie M. Mancho

5 Filed: 04/17/2007

Art Unit: 3664

6 For: SYSTEM AND METHOD FOR SAFELY FLYING UNMANNED AERIAL VEHICLES
7 IN CIVILIAN AIRSPACE

8

9 DECLARATION OF JED MARGOLIN

10

11 I, Jed Margolin, declare as follows:

12

13 1. I am the Applicant in the above patent application.

14

15 2. I am the named inventor (Jed Margolin) on U.S. Patent 5,904,724 **Method and apparatus for**
16 **remotely piloting an aircraft** issued May 18, 1999.

17

18 3. Exhibit 1 is a true and accurate reproduction of the article **NASA Plans UAS Push** by Graham
19 Warwick that appeared in Aviation Week & Space Technology, August 16, 2010, page 13.

20

21 4. Exhibit 2 is a true and accurate reproduction of documents from the image filewrapper for the
22 Duggan Application 10/871,612 that I downloaded from the USPTO's PAIR Web site on or about
23 November 1, 2010.

24

25 5. Exhibit 3 is a true and accurate reproduction of the License Agreement between Geneva
26 Aerospace, Optima Technology, Inc., and myself. I have redacted financial information as per
27 Federal Rules of Civil Procedure Rule 5.2. I have also redacted other sensitive information. (Note
28 that Optima Technology, Inc. subsequently changed their name to Optima Technology Group.)

29

30 6. Exhibit 4 is a true and accurate reproduction of public documents that I downloaded from the
31 Palm Beach County, Florida Web site at http://oris.co.palm-beach.fl.us/or_web1/or_sch_1.asp
32 between approximately August 30, 2010 and September 13, 2010.

1 7. Exhibit 5 is a true and accurate reproduction of the Web page that I downloaded from
2 <http://ntsa.metapress.com/link.asp?id=4mrrc0aupmjpf8e6> on or about November 16, 2010, showing
3 the availability of the paper **Lessons Learned and Future Challenges** by Dr. Dutch Guckenberger
4 and Matt Archer presented at the 2000 Interservice/Industry Training, Simulation & Education
5 Conference (I/ITSEC), and part of Volume: 2000 (Conference Theme: Partnerships for Learning in
6 the New Millennium, followed by the title page and the seventh page from the paper that I
7 purchased from Meta Press on or about November 16, 2010.

8
9 8. Exhibit 6 is a true and accurate reproduction of documents filed by Geneva Aerospace in
10 Trademark Application, Serial Number 78355947 for “Variable Autonomy Control System” that I
11 downloaded from the USPTO Trademark Document Retrieval (TDR) Web site at
12 <http://tportal.uspto.gov/external/portal/tow> on or about November 17, 2010.

13
14 9. Exhibit 7 is a true and accurate reproduction of documents filed by Geneva Aerospace in
15 Trademark Application, Serial Number 78355939 for “VACS” that I downloaded from the USPTO
16 Trademark Document Retrieval (TDR) Web site at <http://tportal.uspto.gov/external/portal/tow> on
17 or about November 17, 2010.

18
19 10. Exhibit 8 is a true and accurate reproduction of the paper **Development and Testing of a**
20 **Variable Autonomy Control System (VACS) for UAVs** by Dave Duggan of Geneva Aerospace
21 and Luis A. Piñeiro of AFRL contained in the Proceedings AUVSI Symposium, 2002, that was
22 given to me by AUVSI (Association of Unmanned Vehicles International) on November 18, 2010.

23
24 11. Exhibit 9 is a true and accurate reproduction of the document contained in Geneva Aerospace
25 Provisional Application 60/480,192 **Small Business Innovation Research (SBIR) Program**
26 **Projects Summary, Topic Number AF98-179**, that I downloaded from PAIR on November 22,
27 2010.

28
29 12. Exhibit 10 is a true and accurate reproduction of the Web page containing Geneva Phase I
30 Contract information for AF98-179 that I downloaded from the Air Force SBIR Web site at
31 <http://www.afsbirsttr.com/TechMall/Default.aspx?kwa=AF98-179> on November 26, 2010.

32

1 **13.** Exhibit 11 is a true and accurate reproduction of the Information Disclosure Statement in the
2 Duggan Provisional Application 60/480,192 that I downloaded from PAIR on November 22, 2010.

3
4 **14.** November 22, 2010 was the first day that Provisional Application 60/480,192 became available
5 to the public on PAIR. Provisional Application 60/480,192 became available to the public on PAIR
6 only as a result of my telephone conversations with Mr. Don Levin (Director of SEARCH AND
7 INFORMATION RESOURCES ADMINISTRATION) and Mr. Richard Fernandez (of that same
8 office) the previous week.

9
10
11 I hereby declare under the penalty of perjury that the foregoing is true and correct to the best of my
12 knowledge and belief.

13

14 Dated: November 29, 2010

15

Jed Margolin
Jed Margolin

1

2

Exhibit 1 – AWST Article **NASA Plans UAS Push**

LEADING EDGE



BY GRAHAM WARWICK

Senior Editor-Technology
Graham Warwick blogs at:
AviationWeek.com/leadingedge
warwick@aviationweek.com

COMMENTARY

NASA Plans UAS Push

Agency uses them for scientific research, but has lacked a focus on UAVs—until now

NASA's Ikhana, a Predator B, will be used in several demonstrations planned under the new program.

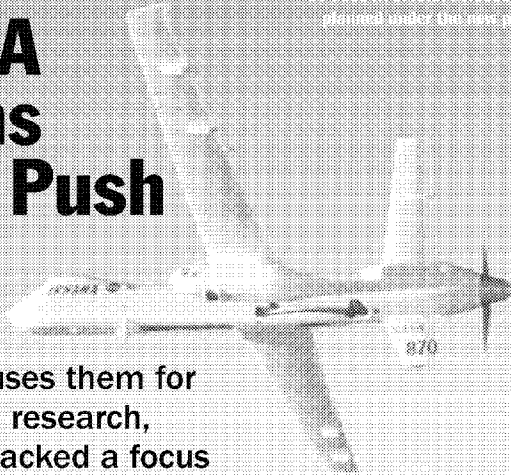

NASA/JIM ROSS

NASA is seeking industry feedback on its plans for a new five-year, \$150-million program to help integrate unmanned aircraft into civil airspace. The feedback is likely to be mixed, as the agency's last major unmanned aircraft research program was canceled before it got off the ground, despite industry backing.

Briefed to industry experts in early August, the Unmanned Air Systems (UAS) Integration in the National Airspace System (NAS) project is planned to begin in Fiscal 2011. It would be NASA's first major unmanned aircraft effort since the High-Altitude Long-Endurance Remotely Operated Aircraft (HALE ROA) project was killed in 2005.

The new program would focus on separation assurance and collision avoidance, pilot-aircraft interface, certification requirements and communications, involving a series of increasingly complex flight demonstrations. The main goal is to generate data to help the FAA and standards organizations develop guidelines and regulations for the design and operation of UASs in the NAS. The research is expected to have an impact in the 2015-25 timeframe.

NASA has tried to avoid duplication with, and identify gaps in, UAS civil-airspace integration efforts already underway, says Jeff Bauer, project planning lead. "Scope has

been the biggest thing we have struggled with—what are the right things to do," he says. The result is a hodge-podge, lacking the singular vision of the HALE ROA project, which was the intended centerpiece of a government-industry plan to enable routine operations by long-endurance UAVs in airspace above 18,000 ft.

Some industry experts believe the new program is too near-term and that NASA should focus on longer-term challenges such as autonomy. Others think the program is "late to need" and that some of the data to be generated are required urgently to support efforts in progress to certify small unmanned aircraft and secure

dedicated frequency spectrum for UAS command-and-control links.

NASA did not have free rein in scoping out the program as its direction from Congress and the Obama administration was to coordinate with the FAA and Defense and Homeland Security departments to address operational and safety issues with UAS integration into the NAS while avoiding duplication.

As a result, the separation assurance and collision-avoidance project will focus on real-time trajectory and contingency monitoring to provide an additional layer of safety for air traffic controllers and UAS operators. NASA will also develop mission planning tools to automate contingency procedures after communications or systems failures while minimizing the impact of UAS operations on air transport system capacity and delays.

The pilot-aircraft interface project will develop guidelines for designing or modifying ground control stations to be compliant with NAS requirements. This could involve adding audible, tactile and visual cues, and will culminate in a proof-of-concept demonstration using a Predator B ground station modified for NAS compliance.

Initially, the communications project will support work underway to secure dedicated "safety of flight" spectrum for UAS command-and-control links at the 2012 World Radiocommunication Conference. Subsequently, the project will develop and test prototypes of a data link radio that meets safety, security and scalability requirements.

Finally, NASA plans to provide the FAA with a methodology for developing airworthiness requirements for the certification of UAS. While some argue that manned aircraft certification rules should be the starting point, the agency believes the balance between probability of failure and severity of consequences used to define airworthiness requirements for passenger-carrying aircraft needs to be reassessed for unmanned aircraft. NASA also plans to assess UAS-specific hazards and risks and develop guidance for type design, focusing on the automation aspects. ☐

1

2

Exhibit 2 – Duggan Filewrapper Documents

-154-

to support transition between the first and second modes of control.

31. A multi-modal variable autonomy control system, the system comprising:

a plurality of control mode components each corresponding to a different mode of control and being configured to respond to command inputs by generating directionally descriptive control commands; and
a unified autopilot component for processing said directionally descriptive control commands.

an vehicle control component for receiving processed commands from the unified autopilot system and actuating control devices accordingly.

32. The system of claim 31, wherein said plurality of control mode components are associated with more than three different modes of control.

33. The system of claim 31, wherein said plurality of control mode components are associated with both autonomous and user-input-based modes of control.

34. The system of claim 31, wherein said plurality of control modes are further configured to respond to

IFW



IN THE UNITED STATES PATENT AND TRADEMARK OFFICE

First Named Inventor : David S. Duggan et al.

Appln. No. : 10/871,612

Filed : June 18, 2004

Group Art Unit: 3661

For : VEHICLE CONTROL SYSTEM INCLUDING RELATED METHODS AND COMPONENTS

Examiner:

Docket No.: G46.12-0001

SUPPLEMENTAL INFORMATION DISCLOSURE STATEMENT

Commissioner for Patents
P.O. Box 1450
Alexandria, VA 22313-1450

I HEREBY CERTIFY THAT THIS PAPER IS BEING SENT BY U.S. MAIL, FIRST CLASS, TO THE COMMISSIONER FOR PATENTS, P.O. BOX 1450, ALEXANDRIA, VA 22313-1450, THIS

19th DAY OF November, 2005
[Signature]
PATENT ATTORNEY

Sir:

The patents or publications listed on the enclosed PTO Form-1449 are submitted pursuant to 37 C.F.R. § 1.97. Copies of the foreign references or "other art" references are included.

LIST REFERENCES NOT SUBMITTED

TIME OF FILING

The information disclosure statement is being filed:

- 1. X 1. Within three months of the filing date of a national application other than a Continued Prosecution Application (CPA);
- 2. Within three months of the date of entry of the National Stage international application;
- 3. Before the mailing date of a first Office Action on the merits; or
- 4. Before the mailing of a first Office Action after the filing of a Request for Continued Examination (RCE).

2. ___ after the time period specified in paragraph 1 above, but before the mailing date of a final action under 37 C.F.R. § 1.113 or notice of allowance under 37 C.F.R. § 1.311. Therefore, in accordance with 37 C.F.R. § 1.97(c), submitted herewith is:

(check either A or B below)

- A. ___ a statement as specified in 37 C.F.R. § 1.97(e).
- B. ___ the fee set forth in 37 C.F.R. § 1.17(p) for submission of an information disclosure statement under 37 C.F.R. § 1.97(c).

3. ___ after the mailing date of either a final action under 37 C.F.R. § 1.113 or a notice of allowance under 37 C.F.R. § 1.311, whichever occurs first, but before payment of the issue fee. Therefore, Applicant petitions for consideration and submits herewith:

- A. a statement as specified in 37 C.F.R. § 1.97(e);
- B. the petition fee set forth in 37 C.F.R. § 1.17(p).

STATEMENT

(only used if No. 2(A) or No. 3 above is checked)

The person(s) signing below certify

(check appropriate paragraph)

___ that each item of information contained in this Information Disclosure Statement was first cited in any communication from a foreign patent office in a counterpart foreign application not more than three months prior to the filing of this statement. 37 C.F.R. § 1.97(e)(1).

OR

___ that no item of information contained in this Information Disclosure Statement was cited in a communication from a foreign patent office in a counterpart foreign application or, to the knowledge of the person signing the certification after making reasonable inquiry, was known to any individual designated in 37 C.F.R. § 1.56(c) more than

three months prior to the filing of this statement. 37
C.F.R. § 1.97(e)(2).

METHOD OF PAYMENT

X No fee is required.
 Attached is a check in the amount of \$.

The Director is authorized to charge any fee deficiency required by this paper or credit any overpayment to Deposit Account No. 23-1123.

Respectfully submitted,

WESTMAN, CHAMPLIN & KELLY, P.A.

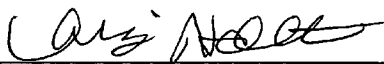
By: 
Christopher L. Holt, Reg. No. 45,844
Suite 1400 - International Centre
900 Second Avenue South
Minneapolis, Minnesota 55402-3319
Phone: (612) 334-3222
Fax: (612) 334-3312

CLH:rkp

| | | |
|---|----------------------------------|--------------------------|
| FORM PTO-1449 | Atty. Docket No.: G46.12-0001 | Appl. No.: 10/871,612 |
| LIST OF PATENTS AND PUBLICATIONS FOR APPLICANT'S INFORMATION DISCLOSURE STATEMENT | First Named Inventor: | |
| | David S. Duggan et al. | |
| | Filing Date | Group Art: |
| | June 18, 2004 | 3661 |



U.S. PATENT DOCUMENTS

| Examiner Initial | Document No. | Date | Name | Class | Sub Class | Filing Date If Appropriate |
|------------------|--|---------|----------|-------|-----------|----------------------------|
| AA | U.S. Patent Pub. No. US 2005-0256938 A1 | 11/2005 | Margolin | 709 | 218 | |
| AB | 5,666,531 | 09/1997 | Martin | 395 | 620 | |
| AC | 5,422,998 | 06/1995 | Margolin | 395 | 166 | |
| AD | 5,553,229 | 09/1996 | Margolin | 395 | 166 | |
| AE | 5,933,156 | 08/1999 | Margolin | 345 | 509 | |
| AF | 5,566,073 | 10/1996 | Margolin | 364 | 449 | |
| AG | 5,904,724 | 05/1999 | Margolin | 701 | 120 | |
| AH | 5,974,423 | 10/1999 | Margolin | 707 | 104 | |
| AI | 6,023,278 | 02/2000 | Margolin | 345 | 419 | |
| AJ | 6,377,436 | 04/2002 | Margolin | 361 | 230 | |
| AK | 6,177,943 | 01/2001 | Margolin | 345 | 419 | |
| AL | 5,978,488 | 11/1999 | Margolin | 381 | 61 | |

FOREIGN PATENT DOCUMENTS

| | Document No. | Date | Country | Class | Sub Class | Translation Yes No |
|----|--------------|------|---------|-------|-----------|--------------------|
| AM | | | | | | |

OTHER ART (Including Author, Title, Date, Pertinent Pages, Etc.)

| | |
|----|--|
| AN | |
| AO | |
| AP | |

EXAMINER:

DATE CONSIDERED:

EXAMINER: Initial if citation considered, whether or not citation is in conformance with MPEP 609; draw line through citation if not in conformance and not considered. Include copy of this form with next communication to applicant.

-5-

Sheet 2 of 2

| | | |
|---|----------------------------------|--------------------------|
| FORM PTO-1449 | Atty. Docket No.: G46.12-0001 | Appl. No.: 10/871,612 |
| LIST OF PATENTS AND PUBLICATIONS FOR APPLICANT'S INFORMATION DISCLOSURE STATEMENT | First Named Inventor: | |
| | David S. Duggan et al. | |
| | Filing Date | Group Art: |
| | June 18, 2004 | 3661 |

U.S. PATENT DOCUMENTS

| Examiner Initial | Document No. | Date | Name | Class | Sub Class | Filing Date If Appropriate |
|------------------|--------------|---------|----------------|-------|-----------|----------------------------|
| AQ | 6,862,501 | 03/2005 | He | 701 | 3 | |
| AR | 6,062,513 | 05/2000 | Lambregts | 244 | 175 | |
| AS | 4,155,525 | 05/1979 | Peter-Contesse | 244 | 182 | |
| AT | 6,304,819 | 10/2001 | Agnew et al. | 701 | 207 | |
| AU | 6,064,939 | 05/2000 | Nishida et al. | 701 | 120 | |
| AV | 6,498,984 | 12/2002 | Agnew et al. | 701 | 207 | |
| AW | | | | | | |

FOREIGN PATENT DOCUMENTS

| | Document No. | Date | Country | Class | Sub Class | Translation Yes No |
|----|--------------|------|---------|-------|-----------|--------------------|
| AX | | | | | | |

OTHER ART (Including Author, Title, Date, Pertinent Pages, Etc.)

| | |
|----|--|
| AY | RIS Press Releases - http://www.landform.com/pages/PressReleases.htm . 4 pgs. |
| AZ | Beringer, D.; "Applying Performance-Controlled Systems, Fuzzy Logic, and Fly-By-Wire Controls to General Aviation Office of Aerospace Medicine, May 2002, pgs. 1-8. |
| BA | R. Parrish et al.; "Spatial Awareness Comparisons Between Large-Screen, Integrated Pictorial Displays and Conventional EFIS Displays During Simulated Landing Approaches," NASA Technical Paper 3467, CECOM Technical Report 94-E-1, October 1994, 1-22. |
| BB | Office of the Secretary of Defense, Airspace Integration Plan for Unmanned Aviation November 2004. |
| BC | Abernathy, M.; "Virtual Cockpit Window" for a Windowless Aerospacecraft. http://www.nasatech.com/Briefs/Jan03/MSC23096.html , Jan. 2003. 2 pgs. |

EXAMINER:

DATE CONSIDERED:

EXAMINER: Initial if citation considered, whether or not citation is in conformance with MPEP 609; draw line through citation if not in conformance and not considered. Include copy of this form with next communication to applicant.

| | | | |
|--------------------------|----------------------------|---------------------|--|
| Interview Summary | Application No. | Applicant(s) | |
| | 10/871,612 | DUGGAN ET AL. | |
| | Examiner | Art Unit | |
| | Gertrude Arthur-Jeanglaude | 3661 | |

All participants (applicant, applicant's representative, PTO personnel):

(1) Gertrude Arthur-Jeanglaude. (3) _____.

(2) Christopher Holt (Reg # 45,844). (4) _____.

Date of Interview: 26 November 2007.

Type: a) Telephonic b) Video Conference
 c) Personal [copy given to: 1) applicant 2) applicant's representative]

Exhibit shown or demonstration conducted: d) Yes e) No.
 If Yes, brief description: _____.

Claim(s) discussed: 31.

Identification of prior art discussed: none.

Agreement with respect to the claims f) was reached. g) was not reached. h) N/A.

Substance of Interview including description of the general nature of what was agreed to if an agreement was reached, or any other comments: To amend claim 31 to correct typo errors.

(A fuller description, if necessary, and a copy of the amendments which the examiner agreed would render the claims allowable, if available, must be attached. Also, where no copy of the amendments that would render the claims allowable is available, a summary thereof must be attached.)

THE FORMAL WRITTEN REPLY TO THE LAST OFFICE ACTION MUST INCLUDE THE SUBSTANCE OF THE INTERVIEW. (See MPEP Section 713.04). If a reply to the last Office action has already been filed, APPLICANT IS GIVEN A NON-EXTENDABLE PERIOD OF THE LONGER OF ONE MONTH OR THIRTY DAYS FROM THIS INTERVIEW DATE, OR THE MAILING DATE OF THIS INTERVIEW SUMMARY FORM, WHICHEVER IS LATER, TO FILE A STATEMENT OF THE SUBSTANCE OF THE INTERVIEW. See Summary of Record of Interview requirements on reverse side or on attached sheet.

Examiner Note: You must sign this form unless it is an Attachment to a signed Office action.

Examiner's signature, if required

1

2

Exhibit 3 – Geneva License Agreement

1



Geneva Aerospace, Inc
4240 International Parkway, Suite 100
Carrollton, TX 75007
469-568-2376
Fax 469-568-2101

May 17th, 2006

SAMUELS, GREEN, STEEL & ADAMS, LLP
Mr. Scott Albrecht, Esq.
19800 MacArthur Blvd, Suite 1000
IRVINE, CA, 92612

SUBJECT: RPV NON-EXCLUSIVE LICENSE AGREEMENT

Dear Mr. Albrecht,

I am enclosing two (2) originals of a "RPV NON-EXCLUSIVE LICENSE AGREEMENT". Please, have both copies signed and dated. Retain one executed original for your files and return one executed copy to Mr. Alan Barker at the above address.

Best regards,

Corinne Leroux
Assistant

2

RPV NON-EXCLUSIVE LICENSE AGREEMENT

This Agreement is made this 01 day of May, 2006 ("Effective Date") by and between Optima Technology Inc. (hereinafter referred to as "Licensor"), a Delaware corporation, Mr. Jed Margolin (hereinafter referred to as "Inventor"), an individual, both having a place of business at 2222 Michelson Drive, Suite 1830, Irvine, California 92612 USA, and Geneva Aerospace®, Inc., a Texas corporation (hereinafter referred to as "Licensee"), having its principal place of business at 4240 International Parkway, Suite 100, Carrollton, TX 75007, individually referred to as "Party" and collectively as the "Parties."

WITNESSED THAT

WHEREAS, as is demonstrated by the document(s) attached hereto as Exhibit A, Licensor has obtained from Inventor the right to provide a license under certain patents as herein identified; and

WHEREAS, Inventor is the named inventor in one or more of said patents; and

WHEREAS, Licensee desires to obtain, and Licensor is willing to grant Licensee, a non-exclusive license as hereafter defined and under the terms and provisions herein specified.

NOW, THEREFORE, in consideration of the promises and mutual agreements herein contained Licensor, Inventor and Licensee agree as follows:

TERMS

1. DEFINITIONS

- 1.1 The term "consist" limits and covers only the elements expressly recited. By contrast, the utilization of the terms "include," "such as," and "for example" are not limited and therefore cover more elements than those recited.
- 1.2 "Affiliate" shall mean any corporation or the like at least fifty percent (50%) of whose voting share capital is owned or directly or indirectly controlled by or under common control with a Party as of the Effective Date of this Agreement or at any time during the term of this Agreement and any other entity over which a Party exercises effective managerial control.
- 1.3 "Days" shall mean calendar days.
- 1.4 "RPV" shall mean "remotely piloted vehicle." A "remotely piloted aircraft" is an RPV. "UAV" shall mean "unmanned aerial vehicle." RPV is an older term for UAV. "UCAV" shall mean "Unmanned Combat Aerial Vehicle." UCAV is also sometimes defined as an "Uninhabited Combat Aerial Vehicle." UCAV is a UAV

that is intended for use in combat. UCAS means "Unmanned Combat Air System."

- 1.5 "Synthetic Vision" is the current term for "Synthetic Environment" and is the three dimensional projected image data presented to the pilot or other observer.
- 1.6 "Patent Portfolio" shall mean the portfolio consisting of United States Patent Numbers 5,904,724 (Method and Apparatus for Remotely Piloting an Aircraft), 5,566,073 (Pilot Aid Using a Synthetic Environment), and those future United States patents that may be added in accordance with the covenants and warranties set forth in Section 8.1.
- 1.7 "Royalty Products" shall mean only the product identified as Licensee Part Number 606-0069-001 missionTEK Synthetic Image Module described as situational awareness aid for a UAV operator using missionTEK. This Part Number excludes the SDS Acuity IG software package hosted on a rack mount computer. This Part Number interfaces to mission TEK through an Ethernet connection and creates a synthetic image of a UAV that is driven by the current vehicle telemetry stream on the product order form attached hereto as Exhibit B. The other products and options identified in Exhibit B are specifically excluded from the definition of "Royalty Products." It is to be understood that Royalty Products shall include systems or components that are manufactured outside the United States, its territories, or possessions and which can reasonably be expected to be used or sold within the United States, its territories, or possessions and/or including and covering all countries on planet Earth and surrounding planets/systems, so long as those systems or components are also identified in Exhibit B as Licensee Part Number 606-0069-001 missionTEK Synthetic Image Module described as situational awareness aid for a UAV operator using missionTEK. This Part Number excludes the SDS Acuity IG software package hosted on a rack mount computer. This Part Number interfaces to mission TEK through an Ethernet connection and creates a synthetic image of a UAV that is driven by the current vehicle telemetry stream.
- 1.8 "Sale or Sold" shall mean selling, leasing, or otherwise transferring ownership, possession, or use to another party, of a Royalty Product (except as scrap), either directly or through a chain of distribution, and shall be deemed to have occurred upon invoicing of a Royalty Product to a third party, or if not invoiced, when ownership, possession, or use is transferred to a third party directly or indirectly.
- 1.9 "Claims" shall mean one or more patent claims identified within the body of a Patent (s).
- 1.10 "Claims in the Patent Portfolio" shall mean Claims identified within the body of a Patent(s) included in the Patent Portfolio (defined in Section 1.6 of this Agreement).

2. LICENSE GRANT

- 2.1 Subject to the terms and provisions of this Agreement, and to Licensee making the payments required under Section 4.1, Licensor and Inventor grants to Licensee a royalty bearing non-exclusive, personal, non-transferable, worldwide right and license under the Claims in the Patent Portfolio to test, make, have made, use, import, export, distribute, offer for sale, sell, lease, and/or otherwise dispose of products in, or for, the United States and its territories and possessions, subject to any applicable export laws and regulations of the United States.
- 2.2 Subject to the terms and provisions of this Agreement, and to Licensee making the payments required under Section 4.1, Licensor and Inventor grants to Licensee the right to extend to its direct and indirect distributors, suppliers, dealers, and customers its right, under the Claims in the Patent Portfolio, to test, make, have made, use, import, export, distribute, offer for sale, sell, lease, and/or otherwise dispose of products in, or for, the United States and its territories and possessions subject to any applicable exports laws and regulations of the United States.
- 2.3 Subject to execution of this agreement by the Parties, Licensor and Inventor release and forever discharge Licensee (and its direct and indirect distributors, suppliers, dealers and customers) from any and all claims, liens, demands, causes of action, obligations, losses, damages, and liabilities, known or unknown, suspected or unsuspected, liquidated or unliquidated, fixed or contingent, that they have had in the past or now have or may have in the future under any of the Claims in the Patent Portfolio based on or arising out of products Sold, prior to and including May 01, 2006 by Licensee in, or for, the United States and its territories and possessions.
- 2.4 Subject to the terms and provisions of this Agreement, and to Licensee making the payment required under Section 4.1 and during the term of the life of this Agreement, Licensor and Inventor further represent, covenant and agree that neither they nor any entity directly or indirectly controlled by either will bring suit or otherwise assert a claim for infringement against Licensee (or its direct and indirect distributors, suppliers, dealers or customers) before any court or administrative agency in any country of the world based on or arising out of products Sold by Licensee in, or for, the United States and its territories and possessions.
- 2.5 The release and covenant not to sue provided in Sections 2.3 and 2.4, as well as any other releases or covenants not to sue set out in this Agreement, shall bind any assignee or other person to whom the Assignor or Inventor may assign ownership or control of Claims in the Patent Portfolio.
- 2.6 Licensor and Inventor grants to Licensee the right to sublicense to an Affiliate of Licensee the rights granted to Licensee under this Agreement; provided that the

Affiliate is bound by the terms and provisions of this Agreement as if it were named in the place of Licensee, and provided that the Affiliate shall pay and account, directly or through Licensee, to the Licensor the royalties payable under this Agreement as a result of the activities of the Affiliate as if it were named in the place of Licensee. Any rights granted to an Affiliate shall terminate automatically and without notice on the date such Affiliate ceases to be an Affiliate; provided, however, that such termination shall not affect the rights granted to the Affiliate for acts occurring prior to the effective date of such termination. Upon written request from Licensor as to whether a particular entity or entities is an Affiliate, Licensee will answer such request in writing within thirty (30) Days from receipt of the request.

- 2.7 The rights, grants, covenants, and terms of Section 2.1, 2.2, 2.4, and 4.1 shall not apply to Royalty Products Sold by Licensee to a third party after Licensee was notified by Licensor that such third party has or had, directly or through others, asserted in any judicial proceeding or judicial document, at any time during the lifetime of this Agreement, that any of the Claims in the Patent Portfolio are invalid and/or not infringed.
- 2.8 The rights, grants, covenants, and terms of Sections 2.1, 2.2, 2.3, 2.4, and 4.1 shall not apply to Royalty Products Sold by Licensee to a third party for sale under a brand not owned or controlled by Licensee unless: (i) such third party has executed with Licensor a License Agreement; and/or (ii) Licensee pays the Royalty, under Sections 4.1 and 4.2, to Licensor for every Royalty Product Sold by such third party in, or for, the United States and its territories and possessions.
3. LIMITS ON SCOPE OF LICENSE GRANT
- 3.1 Any license grant or other authorization that may be provided by Licensor or Inventor to Licensee under this Agreement or to a third party does not provide, directly, by implication, or otherwise, any license grant, or authorization to Licensee to make, have made, use, import, export, distribute, offer for sale, sell, rent, or otherwise dispose of RPV systems for use by R/C hobbyists; and/or to make, have made, test, use, import, export, distribute, offer for sale, sell or lease, or otherwise dispose of equipment used to product or manufacture RPV systems for use by R/C hobbyists.
- 3.2 Any third party which acquires rights under this agreement is bound by the requirements of section 3.1.
4. ROYALTY AND PAYMENTS
- 4.1 In consideration for the licenses, covenants not to sue, and other rights granted by Licensor and Inventor to Licensee under this Agreement relative to Royalty Products Sold by Licensee in, or for, the United States and its territories and possessions and/or including and covering all countries on planet Earth and

surrounding planets/systems after May, 01, 2006, Licensee agrees to pay Licensor a continuing "Royalty" throughout the term of this Agreement equal to five percent (5%) for each such Royalty Product.

- 4.2 [DELETED BY PARTIES DURING NEGOTIATION]
- 4.3 Only one Royalty shall be paid on any Royalty Product with respect to the Claims in the Patent Portfolio regardless as to whether the Royalty Product is encompassed by one or more of the Claims in the Patent Portfolio. Licensee shall not be required to make payments under Section 4.1 as to Royalty Products Sold by Licensee where the Royalty due has been paid to Licensor by a third party. Licensee shall not be required to make payments under Section 4.1 as to Royalty Products Sold by Licensee and subsequently found defective and returned to Licensee for full credit, and not thereafter Sold by Licensee in, or for, the United States and its territories and possession and/or including and covering all countries on planet Earth and surrounding planets/systems.
- 4.4 The Parties understand that there should be no taxes imposed by any foreign country on the income of Licensor paid under this Agreement. However, to the extent, if any, that such taxes are imposed for any reason: (i) such taxes shall be borne by Licensor; (ii) Licensee will deduct such tax from the amounts payable to Licensor and pay such tax to the appropriate authority in the name of and on behalf of Licensor; (iii) Licensee shall send to Licensor certificates of tax payment in due course after each payment of the tax; and (iv) Licensee agrees to submit and to file any document to the competent foreign revenue office, that is required to have such certificate issued.
- 4.5 If any other entity is granted a license under any of the Claims in the Patent Portfolio with respect to Royalty Products under any more favorable economic terms than those granted to Licensee under this Agreement, then Licensor shall disclose, in writing, to Licensee the terms and provisions of each such license within thirty (30) Days of its execution, and Licensee shall have the right, within ninety (90) Days of receipt of such disclosure, to substitute all of the terms and provisions in this Agreement with all of the terms and provisions of the subsequent license, retroactive to the date that the subsequent license agreement was executed.
5. REPORTS
- 5.1 Licensee shall keep sales records of all Royalty Products Sold by Licensee during the term of this Agreement in, or for, the United States and its territories and possessions and/or including and covering all countries on planet Earth and surrounding planets/systems. These sales records shall be of sufficient detail to permit verification in accordance with the accuracy and completeness of the information and the royalties required to be reported and paid under this

Agreement. Licensee shall keep such records for at least five (5) years after each due date for royalty payments under this Agreement.

- 5.2 Licensee shall send Licensor a written "Royalty Report", accompanied in the manner provided for in Section 5.7 by the proper amount then payable to Licensor as shown in such Royalty Report,:
- (a) on or before the thirtieth (30th) day after termination of this Agreement; and
 - (b) on or before the last day of the months of January, April, July and October of each year during the term of this Agreement. However, if less than one thousand Royalty Products are Sold by Licensee in, or for, the United States and its territories and possessions and/or including and covering all countries on planet Earth and surrounding planets/systems during a calendar year, then the four (4) quarterly reports and payments for the next calendar year immediately following may be combined in a single annual Royalty Report and payment made on or before the last day of January immediately following such next calendar year.
- 5.3 The Royalty Report shall be certified in its correctness by Licensee's representative responsible for paying such on Licensee's behalf in the normal course of Licensee's business, and providing information such as:
- (a) the total number of Royalty Products, by product category, Sold by Licensee in; or for, the United States and its territories and possessions and/or including and covering all countries on planet Earth and surrounding planets/systems during the preceding calendar quarter;
 - (b) the royalty amount due for such calendar quarter; and
 - (c) the total number of Royalty Products, by product category, Sold by Licensee in, or for, the United States and its territories and possessions and/or including and covering all countries on planet Earth and surrounding planets/systems during such calendar quarter for which the Royalty due from Licensee was paid for by a third party and an identification of each such third party.
- 5.4 In the event that any Royalty Report and payment are not made by or on behalf of Licensee by the date provided under this Agreement, interest shall be payable on the past due amounts at the rate of the prime lending rate as published in the Wall Street Journal from time to time plus 2%, compounded semi-annually. This interest shall be calculated from the date payment was due to the payment date. This interest payment shall be in addition to any other remedy provided to Licensor by law or by this Agreement.

- 5.5 Licensor shall maintain Royalty Reports of Licensee as "Confidential Information" in accordance with Article 9 of this Agreement. Confidential Information shall also include any other information provided by Licensee to Licensor and which is designated in good faith as confidential by Licensee.
- 5.6 Licensor shall have the right, during reasonable business hours and at the reasonable convenience of Licensee, to have the correctness of any Royalty Report of Licensee audited, at licensor's expense, by a firm of independent public accountants, selected by Licensor, and reasonably acceptable to Licensee. The independent public accountants shall examine Licensee's records only on matters pertinent to this Agreement. Nor more than one such audit shall be performed per year, unless Licensee has underreported as provided in the following sentence. In the event it is determined by the independent public accountants, at any time, that Licensee has underreported in an amount in excess of five percent (5%) of the royalties properly due with respect to one or more Royalty Reports, then Licensee, in addition to any other remedy provided Licensor by law or by this Agreement, agrees and is bound to:
- (a) Reimburse Licensor's full cost and expense associated with the audit; and
 - (b) Pay Licensor an amount equal to one hundred and twenty-five (125%) of the amount that Licensee has failed to report or pay, along with interest at the rate of the prime lending rate as published in the Wall Street Journal from time to time plus two percent (2%), compounded semi-annually, calculated from the date each royalty accrued to the date of payment under this Section.

Any payments due under this Section shall be due and payable within thirty (30) Days following notice from Licensor of such failure, breach or default.

- 5.7 All royalty payments under this Agreement shall be paid in United States currency, without deductions of taxes of any kind other than as provided for in Section 4.4, payable to Licensor c/o SAMUELS, GREEN, STEEL & ADAMS, LLP, Scott Albrecht, Esq.; at 19800 Macarthur Blvd., Suite 1000, Irvine, California 92612-2433, U.S.A. by wire transfer to:

SAMUELS, GREEN, STEEL & ADAMS, LLP
Scott Albrecht, Esq.; P.C. Client Trust

[Financial Information Redacted]

or to any other U.S.A. accounts, as instructed jointly and in writing by Licensor and Scott Albrecht, Esq.

- 5.8 In the event applicable exchange control regulations shall prevent remittance of United States currency payment hereunder by Licensee, Licensee agrees, at Licensor's option and in accordance with the requirement to make payments without deductions of taxes of any kind other than as provided for in Section 4.4, to deposit an equivalent amount in a currency as designated by Licensor, in a bank designated by Licensor for the account of Licensor, such equivalent amounts to be calculated using currency tables published in the Wall Street Journal.
6. TERM AND TERMINATION
- 6.1 This Agreement shall continue in full force and effect, unless sooner terminated by specific provisions in this Agreement, until the expiration date of the last remaining of the Claims in the Patent Portfolio, or until a final decree of invalidity from which no appeal or other judicial recourse can be, or is, taken of the last remaining of the Claims in the Patent Portfolio.
- 6.2 Licensee may terminate this Agreement at any time by sixty (60) Days written notice to Licensor.
- 6.3 Licensor may terminate this Agreement forthwith upon written notice to Licensee if:
- (a) Licensee remains in default in making any payment or supplying a Royalty report or fails to comply with any other provision for a period of thirty (30) Days, in each case after written notice of such default or failure is given by Licensor to Licensee, unless a genuine and good faith dispute exists as to the amount due and any amounts not in dispute are timely paid;
 - (b) Licensee shall make an assignment for the benefit of creditors, or any order for the compulsory liquidation of Licensee shall be made by any court;
 - (c) Licensee shall be finally determined by a court of competent jurisdiction to have (i) willfully or deliberately violated any material provision of this Agreement; (ii) concealed from Licensor any failure to comply with this Agreement including, but not limited to, the deliberate or willful understatement of royalties payable or the express refusal to timely pay royalties; and/or (iii) acted in bad faith in breaching any material provision of this Agreement. In such an event, the termination shall be effective as of the date of notice given by Licensor; and
 - (d) Licensee and/or any of its Affiliates, during the term of the Agreement, directly or through others, assert in any judicial proceeding or judicial document that any of the Claims in the Patent Portfolio are invalid.

6.4 Any termination of this Agreement shall not relieve Licensee of its liability for any payments accrued or owing prior to the effective date of such termination, or for any payments on Royalty Products manufactured by Licensee, in whole or in part, and located in the United States and its territories and possessions and/or including and covering all countries on planet Earth and surrounding planets/systems, prior to the effective date of such termination and Sold after the termination date.

7. ASSIGNMENTS

7.1 This Agreement may be assigned by Licensor provided that the assignment does not operate to terminate, impair or in any way change any obligations or rights that Licensor currently has under this Agreement, or any of the obligations or rights that Licensee would have had, if the assignment has not occurred. In the event the assignment is to a competitor of Licensee, Licensor and Inventor will continue to receive Royalty Reports made by Licensee on a confidential basis and will not reveal the contents of the Royalty Reports to the assignee.

7.2 This Agreement shall inure to the benefit of, and be binding upon, the successors and assigns of the Parties, but no purported assignment or transfer by Licensee of this Agreement or any part thereof shall have any force or validity whatsoever unless and until approved in writing by Licensor, except an assignment to a direct or indirect wholly-owned subsidiary of Licensee, or to a buyer of all or substantially all of an entire business unit or product line of Licensee to which this license pertains. However, any purported conveyance or any attempt by Licensee to confer or extend the benefits and privileges of this Agreement upon or to any entity shall be void and ineffective if that entity: (i) shall have, directly or indirectly, rejected or declined to accept a license from Licensor upon like, similar or more favorable terms as embodiment herein; and/or (ii) directly or through others, asserted in any judicial proceeding or document that any of the Claims in the Patent Portfolio are invalid.

8. COVENANTS, REPRESENTATIONS AND WARRANTIES

8.1 Licensor and Inventor warrant and covenant that: (i) if during the term of this Agreement, they own, control or acquire additional Claim(s), this Agreement will be supplemented to include such additional Claim(s) without the payment by Licensee of any royalties other than those required to be paid under this Agreement; (ii) they have the entire right, title and interest in and to the Claims in the Patent Portfolio; (iii) they have the right and authority to enter into this Agreement; (iv) they do not own or control any foreign issued patents or foreign pending patent applications; and (v) there are no liens, conveyances, mortgages, assignments, encumbrances or other agreements to which Licensor or Inventor are a party, or by which they are bound, that would prevent or impair the full exercise

of all substantive rights granted to Licensee by Licensor pursuant to the terms and provisions of this Agreement.

- 8.2 Licensor and inventor make no representation or warranty that Royalty Products will not infringe, directly, contributorily or by inducement under the laws of the United States or any foreign country, any patent or other intellectual property right of a third party.
- 8.3 Any dispute arising under or relating to this Agreement or in any dispute arising with respect or related to the subject matter of the Claims in the Patent Portfolio, which cannot be resolved by negotiation in good faith between the parties hereto, shall be resolved by an action brought in, and the Parties and their Affiliates who have agreed to be bound by this Agreement consent to the jurisdiction and venue of a court in the State of Delaware, U.S.A. Without regard to those laws relating to conflict of laws and the parties to this agreement hereby submit to the jurisdiction of the courts in the State of Delaware, U.S.A. in connection with any disputes arising out of this Agreement.
- 8.4 Licensee hereby submits for itself and its property in any legal action or proceeding relating to this Agreement, or for recognition and any enforcement of any judgment in respect thereof, to the non-exclusive general jurisdiction and forum of the courts of the State of Delaware in the United States of America, the courts of the United States of America for the District of Delaware, and appellate courts from any thereof. Licensee agrees not to raise, and waives, any objections or defenses based upon venue or forum non conveniens, except that Licensor may seek temporary injunctive relief in any venue of its choosing.
- 8.5 Licensee hereby designates the following agent in the United States for any service of any summons, complaint or other process in connection with any litigation arising out of this Agreement and Licensee agrees and certifies that such agent shall have full authority to accept the same on behalf of Licensee:

Name: W. Alan Barker, Geneva Legal Counsel
Address: 4240 International Parkway
Suite 100
Carrollton, Texas 75007
Tel.: (469) 568-2376 x112
Fax: (469) 568-2100
Email: abarker@genevaerospace.com

- 8.6 Licensee represents and warrants that Licensee assumes responsibility for obtaining all necessary official government approval, validation, and/or consent from the appropriate governmental authorities for the performance of this Agreement and for remittance of payment pursuant hereto and for registering or recording this Agreement as required; provided, however, that Licensee shall use its best efforts to provide that Licensor shall have the right to participate or be

- represented in any proceeding, hearing, negotiation or the like with governmental authorities relating to such approval, validation and/or consent.
- 8.7 Licensee and its Affiliates shall, upon request, grant to Licensor, Inventor, and/or their Affiliates a non-exclusive license to and release from any and all claims of infringement of any patents that are necessarily infringed when implementing the Intellectual Property or claiming technologies for which there is no realistic alternative in implementing the Intellectual Property and with respect to which Licensee has or may in the future obtain rights or controls, directly or indirectly, to grant such a license and release. Any such licenses and release shall be granted upon fair, reasonable, and non-discriminatory terms and provisions.
- 8.8 Every Party represents and warrants that in executing this Agreement, other than the promises, warranties and representations expressly made in this Agreement, it does not rely on any promises, inducements, or representations made by any Party or third party with respect to this Agreement or any other business dealings with any Party or third party, now or in the future.
- 8.9 Every Party represents and warrants that it is not presently the subject of a voluntary or involuntary petition in bankruptcy or the equivalent thereof, is not presently contemplating filing any such voluntary petition, and does not presently have reason to believe that such an involuntary petition will be filed against it.
- 8.10 Other than the express warranties of this Article, there are no other warranties, express or implied.
9. CONFIDENTIAL INFORMATION
- 9.1 For a period of five (5) years as measured from the first date of disclosure of Confidential Information pursuant to this Agreement, Licensor and Inventor agree to use reasonable care and discretion, at least commensurate with that degree of reasonable care they use to protect similar information of their own, to avoid disclosure, publication or dissemination of Confidential Information, outside of those employees, attorneys or consultants of Licensor, and independent public accountants selected by Licensor pursuant to Section 5.6, who have a need to know Confidential Information, and are bound by the terms of this Article to keep Confidential Information in confidence.
- 9.2 Disclosure by Licensor or Inventor of Confidential Information under Section 9.1 of this Agreement shall be permitted in the following circumstances; provided, that Licensor and Inventor shall have first given reasonable notice to Licensee that such disclosure is to be made:
- (a) in response to an order of a court, government or governmental body;
 - (b) otherwise as required by law; or

- (c) to the independent public accountants selected in accordance with Section 5.6 who agree in writing to maintain Confidential Information in confidence.

9.3 Notwithstanding any other provisions of this Agreement, the obligations specified in Section 9.1 of this Agreement will not apply to any Confidential Information that:

- (a) is or become publicly available without breach of this Agreement;
- (b) is released for disclosure by written consent of Licensee;
- (c) can be shown by written documentation to have already been in Licensor's or Inventor's possession at the time of its receipt from Licensee; or
- (d) is disclosed to Licensor or Inventor by a third party without Licensor's or Inventor's knowledge of any breach of any obligation or confidentiality owed to Licensee.

10. MISCELLANEOUS

10.1 All notices to, demands, consents, and communications that any Party may desire to give to the other, and/or may be required under this Agreement, must be in writing. The notice shall be effective upon receipt in the United States after having been sent by registered or certified mail or sent by facsimile transmission; and shall be effective upon receipt outside the United States after having been delivered prepaid to a reputable international delivery service or courier or sent by facsimile transmission; and addressed to the address designated below:

For notice to Licensor:

SAMUELS, GREEN, STEEL & ADAMS, LLP,
Mr. Mark Adams, Esq.
19800 MacArthur Blvd., Suite 1000
Irvine, CA 92612

For notice to Licensee:

W. Alan Barker, Geneva Legal Counsel
4240 International Parkway
Suite 100
Carrollton, Texas 75007
Tel: (469) 568-2376 x112
Fax: (469) 568-2100
Email: abarker@genevaaerospace.com

Or to such address that the Party to whom notices are to be sent may from time to time designate in writing.

- 10.2 No failure or delay to act upon any default or to exercise any right, power or remedy under this Agreement will operate as a waiver of any such default, right, power or remedy.
- 10.3 This Agreement constitutes the entire understanding of the Parties with respect to its subject matter and supersedes all prior oral or written negotiations, agreements and understandings. This Agreement may not be modified or amended except in writing duly signed by authorized persons on behalf of the Parties.
- 10.4 The validity, construction, interpretation and performance of this Agreement, and any disputes or legal actions arising under or from this Agreement, shall be governed by the laws and regulations of the United States of America as to patent law, and the State of Delaware as applied to contracts.
- 10.5 Each of the terms and provisions of this Agreement is material. Without such terms and provisions the Parties would not have entered into this Agreement. If any term or provision of this Agreement is, becomes, or is deemed invalid, illegal or unenforceable under the applicable laws or regulations in the United States or any of its jurisdictions including, for example, the State of Delaware, such term or provision may be amended, by mutual agreement between Licensor and Licensee, to the extent necessary to conform to applicable laws or regulations without materially altering the intention of the parties or, if it cannot be so amended by good-faith negotiations and agreement between Licensor and Licensee then this Agreement shall be terminated sixty (60) days following such term or provision becoming or being deemed invalid, illegal or unenforceable.
- 10.6 This Agreement does not constitute either Party the agent of the other Party for any purpose whatsoever, nor does either Party have the right or authority to assume, create or incur any liability of any kind, express or implied, against or in the name or on behalf of the other Party.
- 10.7 The English language form of this Agreement shall control and determine its interpretation.

IN WITNESS WHEREOF, the parties hereto have caused this RPV License Agreement to be executed by their respective duly authorized officers as of the Effective Date.

OPTIMA TECHNOLOGY INC.

Date: May 01, 2006

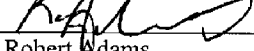
By: 
Robert Adams
As CEO, Optima Technology Inc.

Date: May 25, 2006.

By: 
Jed Margolin
Inventor

GENEVA AEROSPACE®, INC.

Date: May 17, 2006.

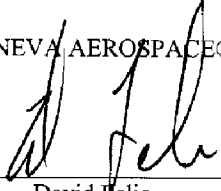
By: 
David Helio
As CEO/President
Geneva Aerospace, Inc.

This Agreement shall not be effective unless an original or a fax copy of this signature page fully executing this Agreement is received by Licensor within twenty-one (21) Days of the Effective Date.

Exhibit A

Optima Technology
Proprietary & Confidential
Information

[Redacted]



Commercial Price List

Exhibit B

| Geneva P/N | Name | Description | List Price |
|--|---|---|--------------|
| Flight Controls | | | |
| 606-0022-001 | flightTEK for Fixed Wing No Navigator | flightTEK computer with internal GPS and fixed wing VACS software. No cabling or GPS antenna. | \$ 11,900.00 |
| 606-0023-001 | flightTEK for Airship No Navigator | flightTEK computer with internal GPS and airship VACS software. No cabling or GPS antenna. | \$ 20,500.00 |
| 606-0022-002 | flightTEK Extended Use | Same as above with the addition of a web interface that permits the customer to modify the autopilot gains. | \$ 11,900.00 |
| 606-0023-002 | flightTEK Airship Extended Use | Same as above with the addition of a web interface that permits the customer to modify the autopilot gains. | \$ 20,500.00 |
| 606-0024-001 | flightTEK Standard Cable Set | Standard cable set not including the GPS RF cable. Cable is based on Dakota configuration. | \$ 2,900.00 |
| 606-0025-001 | flightTEK PIL Cable Set | Standard bench cable that breaks out all of the flightTEK interfaces | \$ 1,200.00 |
| 606-0026-001 | flightTEK Custom Cable Set Design | Non-standard cable set design to interface to special payloads or other airborne components. Comes with a single cable set to aid in fit checks and integration. | \$ 23,000.00 |
| Defined at design | flightTEK Custom Cable Set | Single cable set designed to specifications from the custom cable set design effort | \$ 3,100.00 |
| 606-0027-002 | flightTEK GPS Antenna | Active GPS antenna and TBD II, RF cable | \$ 490.00 |
| flightTEK VACS Software Options | | | |
| 820-0011-001 | Navigator Software | 15 state Kalman filter that provides the full navigation slate. | \$ 1,000.00 |
| 606-0068-001 | SIL 6DOF SDK | Development environment that supports the extended use flightTEK. Allows the user to create a model of the aircraft and test the flightTEK gain settings against the airframe model. Includes a pre-compiled library for use on a ??? OS and Visual C++ compiler environment. | \$ 15,000.00 |
| 606-0050-001 | PILHIL 6DOF SDK System | Development environment that supports the extended use flightTEK. Allows the user to create a model of the aircraft and test the flightTEK gain settings against the airframe model in a real-time PILHIL environment. Includes a pre-compiled library for use on a Linux OS and a preloaded Box PC. | \$ 5,000.00 |
| flightTEK IMU/INS | | | |
| 606-0028-001 | Systron Donner CMIGITS III INS | Includes the CMIGITS hardware and the software interface driver | \$ 30,850.00 |
| 606-0029-001 | CMIGITS Mount w/ 12v/28v DC-DC converter | Standard Dakota mount with interface cable and 12v/28v DC-DC power converter | \$ 2,000.00 |
| 606-0030-001 | CMIGITS Mount (28v) | Standard Dakota mount with interface cable without power converter (28v) | \$ 1,500.00 |
| 606-0031-001 | Systron Donner MMQ IMU Assembly | Includes the MMQ hardware, LVDS board converter, TBD in, cable between MMQ and LVDS board, and the software interface driver | \$ 7,200.00 |
| 606-0032-001 | Crossbow IMU | Includes the Crossbow hardware and the software interface driver | \$ 4,900.00 |
| 606-0033-001 | Microstrain IMU | Includes Microstrain hardware and the software interface driver | \$ 1,900.00 |
| 606-0065-001 | Interface Panel | Includes ADS sensor, RC to autonomous flight switching, FTS interface | \$ 7,000.00 |
| 606-0035-001 | ADS Sensor - Setra | ADS sensor w/ tubing - Setra | \$ 550.00 |
| 606-0035-002 | ADS Sensor - All Sensors | ADS sensor w/ tubing - All Sensors | \$ 550.00 |
| Data Link for Air Vehicles | | | |
| 606-0036-001 | linkTEK DV | Transmits data & video via 802.11b for LOS or via optional satcom link for BLOS. Video is transmitted as digital data compressed using JPEG2000 compression. 4 ethernet ports on an internal switch are provided. If flightTEK is used, one ethernet port will be used. 1 watt internal power amp for 802.11b is included. | \$ 9,950.00 |
| 606-0036-002 | linkTEK DV No Amp | Same as linkTEK DV but does not include internal 802.11b power amp. | \$ 8,600.00 |
| 606-0037-001 | linkTEK D | Same as linkTEK DV but does not include video. | \$ 9,200.00 |
| 606-0037-002 | linkTEK D No Amp | Same as linkTEK DV No Amp but does not include video. | \$ 8,000.00 |
| 606-0038-001 | SATCOM - 1 | Satcom modem enclosure with a single GlobalStar modem, TBD in, of RF cable, 24 in. serial interface cable, and a single GlobalStar antenna. | \$ 4,400.00 |
| 606-0038-002 | SATCOM - 2 | Satcom modem enclosure with two GlobalStar modems, TBD in, of RF cables, 24 in. serial interface cable, and two GlobalStar antennas. | \$ 7,200.00 |
| 606-0041-001 | linkTEK Developer Kit | Power cable, power supply, and RJ45 cable, and 3' rubber duck antenna. | \$ 950.00 |
| 606-0039-001 | Serial Datalink 225-400 MHz | Radio hardware with TBD in, RF cable and vehicle antenna | \$ 5,200.00 |
| 606-0040-001 | Serial Datalink 900 MHz | Radio hardware with TBD in, RF cable and vehicle antenna | \$ 1,750.00 |
| 606-0042-001 | Serial Datalink Developer Kit | Power cable, power supply, and RJ45 cable, and 3' rubber duck antenna. | \$ 950.00 |
| Control Stations | | | |
| 820-0012-001 | missionTEK Software | Runs on Windows 2000, NT, or XP. Capable of commanding all available flight modes. | \$ 15,000.00 |
| 606-0010-001 | missionTEK Computer | Includes a Panasonic Toughbook, mouse, and joystick. | \$ 4,500.00 |
| 606-0069-001 | missionTEK Synthetic Image Module | This product is an interface module that enables missionTEK support unmanned vehicle operator situational awareness aids. The product provides an interface to the AAcuity® PC-IG System sold by SDS International. The product requires missionTEK to be connected to the PC-IG system through an Ethernet connection and provides the PC-IG system periodic vehicle data that is used to generate a synthetic image of the vehicle relative to a 3-D terrain environment. | \$ 2,000.00 |
| 606-0037-003 | linkTEK D - GCS | Same as linkTEK D for the air vehicle and includes power supply, power cable, interface cables, and 3' quarter wave rubber duck antenna. | \$ 9,700.00 |
| 606-0037-004 | linkTEK D No Amp - GCS | Same as linkTEK D - GCS except no 802.11b power amp. | \$ 9,000.00 |
| 606-0038-003 | SATCOM - 1 - GCS | Satcom modem enclosure with a single GlobalStar modem, TBD in, of RF cable, 24 in. serial interface cable, and a single GlobalStar antenna. | \$ 5,200.00 |
| 606-0038-004 | SATCOM - 2 - GCS | Same as SATCOM - 1 except an additional GlobalStar modem, RF cable, and antenna is included. | \$ 8,600.00 |
| 606-0043-001 | linkTEK Comm Kit | 802.11b antenna, RF cables, antenna masts, | \$ 1,250.00 |
| 606-0039-002 | Serial Datalink 225-400 MHz - GCS | 225-400 MHz radio hardware in ruggedized enclosure with ground power cord | \$ 4,600.00 |
| 606-0040-002 | Serial Datalink 900 MHz - GCS | 900 MHz radio hardware in ruggedized enclosure with ground power cord | \$ 2,000.00 |
| 501-xxxx-xxx | linkTEK / Serial Datalink Interface Cable | Interface cable required when using linkTEK to support multi-vehicle control | \$ 130.00 |
| 606-0043-002 | Serial Datalink Comm Kit | 900 MHz Omni antenna, 3dB Omnidirectional UHF antenna, 30' RF cable, antenna masts, mast mounting kit, mast stand | \$ 950.00 |
| 606-0051-001 | Ground Control Station - Packaged Option | GCS Box with power supply and integrated with purchased Control Station Components | \$ 1,900.00 |
| Flight Termination | | | |
| 606-0044-001 | safeTEK Air | Receiver, backup battery pack, TBD in, RF cable, and antenna | \$ 4,500.00 |
| 602-0042-001 | safeTEK Ground | Rack mount with ability to independently command 3 safeTEK air units. Comes with power cord. | \$ 8,750.00 |
| 606-0043-003 | safeTEK Ground Comm Kit | Antenna, RF cable, mast | \$ 1,950.00 |

1
2

Exhibit 4 - Public Records from Palm Beach County, Florida

1



CFN 20060462327
 OR BK 20706 PG 0325
 RECORDED 08/08/2006 15:46:06
 Palm Beach County, Florida
 ART 1, 012, 602.00
 Doc Stamp 7,088.90
 Sharon R. Bock, CLERK & COMPTROLLER
 Pgs 0325 - 326; (2pgs)

RETURN TO:
NOVA TITLE COMPANY
 1401 UNIVERSITY DR. SUITE 402
 CORAL SPRINGS, FL 33071-9909
 (954) 755-9889

W/C 84

SPECIAL WARRANTY DEED

THIS INDENTURE is made this 03 day of August, 2006, between **BOYNTON BEACH ASSOCIATES XVI, LLLP**, a Florida limited liability limited partnership ("Seller") whose post office address is 1600 Sawgrass Corporate Parkway, Suite 300, Sunrise, Florida 33323, and Jean Bruner Jeanglaude and Gertrude Arthur-Jeanglaude, husband and wife ("Buyer"), whose Social Security Numbers are _____ and _____, respectively, and whose post office address is 8671 Thornbrook Terrace Point, Boynton Beach, Florida 33437.

WITNESSETH, that Seller, for and in consideration of the sum of TEN AND NO/100 DOLLARS (\$10.00) and other good and valuable consideration to Seller in hand paid by Buyer, the receipt and sufficiency of which are hereby acknowledged, has granted, bargained and sold, and hereby grants, bargains and sells to Buyer, and Buyer's heirs, successors and assigns forever, the following described land, with a Property Appraiser's Identification Number of **00 42 45 32 03 000 1170**.

Lot 117 , CANYON ISLES - PLAT ONE, according to the plat thereof, as recorded in Plat Book 105 at Page 1, of the Public Records of Palm Beach County, Florida.

THIS CONVEYANCE AND TITLE TO SAID PROPERTY is subject to: (a) taxes and assessments for the present year and subsequent years, including, but not limited to, pending and certified county or municipal improvement liens; (b) restrictions, reservations, conditions, limitations, easements and other matters of record or imposed by governmental authorities having jurisdiction or control over the subject property, but this reference shall not operate to reimpose any of same; (c) all laws, ordinances, regulations, restrictions, prohibitions and other requirements imposed by governmental authorities, including, but not limited to, all applicable zoning, building, bulkhead, land use and environmental ordinances, rules and regulations, and rights or interests vested in the United States of America and/or the State of Florida; (d) those certain covenants, restrictions, agreements and lien rights set forth in **Exhibit "A"** attached hereto and by this reference made a part hereof; (e) the Declaration of Covenants, Restrictions and Easements for Canyon Isles, dated January 18, 2006 and recorded January 20, 2006 in Official Records Book 19820, at Page 216 of the Public Records of Palm Beach County, Florida, as amended and/or supplemented from time to time; (f) the plat of Canyon Isles - Plat One, as recorded in Plat Book 105, at Page 1 of the Public Records of Palm Beach County, Florida; (g) the plat of Canyon Isles - Plat Two, as recorded in Plat Book 105, at Page 40 of the Public Records of Palm Beach County, Florida; and (h) the plat of Canyon Isles - Plat Three, as recorded in Plat Book 106, at Page 61 of the Public Records of Palm Beach County, Florida.

SELLER does hereby specially warrant the title to said land, subject to the foregoing matters, and will defend same against the lawful claims of all persons claiming by, through or under Seller and no others.

IN WITNESS WHEREOF, Seller has hereunto set Seller's hand and seal the day and year first above written.

WITNESSES:

BOYNTON BEACH ASSOCIATES XVI, LLLP, a Florida limited liability limited partnership
 By: Boynton Beach XVI Corporation, a Florida corporation, its general partner

Print Name of Witness: Evelyn Duenas

By:
 N. Maria Menendez, Vice President

Print Name of Witness: Evelyn Duenas

STATE OF FLORIDA
 COUNTY OF BROWARD

The foregoing instrument was acknowledged before me this 03 day of August, 2006, by N. Maria Menendez, as Vice President of Boynton Beach XVI Corporation, a Florida corporation, the general partner of Boynton Beach Associates XVI, LLLP, a Florida limited liability limited partnership, on behalf of said corporation and limited liability limited partnership. She is personally known to me.

Notary Public
 My Commission Expires:

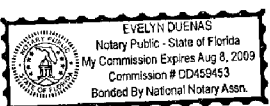

This instrument prepared by:
HENRY W. JOHNSON, ESQ.
HUME & JOHNSON, P.A.
 1401 University Drive, #301
 Coral Springs, Florida 33071
 (954) 755-9880

2

EXHIBIT "A"
COVENANTS, RESTRICTIONS, AGREEMENTS AND LIEN RIGHTS

The title to the property described in the Special Warranty Deed to which this **Exhibit "A"** is attached (the "Deed") shall be subject to and burdened by the covenants, restrictions, agreements and lien rights set forth below:

1. **Capitalized Terms and Definitions.** All initial capitalized terms used in this **Exhibit "A"** but not defined herein shall have the meanings given to such terms as set forth in the Deed. The following terms as used in this **Exhibit "A"** shall have the meanings given to such terms as set forth below.

"**Gain**" shall mean and refer to the amount, if any, by which: (i) the gross selling price of the Property (less and except: (y) the actual, documented costs of any physical improvements made by Buyer after the date of the Deed to the exterior of the home on the Property such as pools, patios, screen enclosures and extensions, and (z) the actual, documented closing costs required to be paid by Buyer in connection with the sale of the Property such as documentary stamp taxes, recording fees and/or brokerage commissions), exceeds (ii) the "Total Purchase Price" paid to Seller by Buyer pursuant to and as defined in the Purchase Contract executed by Seller and Buyer.

"**Hardship Event**" shall mean and refer to a sale, transfer, lease or sublet of the Property, as appropriate, following a divorce of the Buyers (if married to each other), death or serious disability of one or more of the Buyers, job transfer of one or more of the Buyers to a location greater than fifty (50) miles from the Property, or other reason acceptable to Seller in Seller's sole and absolute discretion, as evidenced by a written waiver of this provision given by Seller.

"**Property**" shall mean and refer to the property described in the Deed together with the improvements thereon.

"**Transfer Advertisement or Agreement**" shall mean and refer to any or all of the following: (i) any listing or advertisement for the sale or lease of the Property or any portion thereof made with a broker, in any multiple listing service, in any classified or other advertisement, or otherwise (including, without limitation, "by owner"), (ii) any agreement (verbal or written) for transfer of title to the Property to any third party, and/or (iii) any agreement (verbal or written) for the leasing and/or subletting of the Property or any portion thereof, notwithstanding anything to the contrary in the Declaration.

2. **Sales/Transfers of the Property.** In the event that Buyer sells or transfers title to the Property (directly or indirectly): (a) at any time within one (1) year following the date of the Deed, and/or (b) at any time thereafter if such sale or transfer results from a Transfer Advertisement or Agreement made or entered into within one (1) year following the date of the Deed, then except only in the event of a Hardship Event released by Seller as provided in Paragraph 4 below, Buyer shall pay to Seller from the proceeds of such sale or transfer, an amount equal to one-hundred percent (100%) of the Gain realized from such sale or transfer.

3. **No Leasing of the Property.** Notwithstanding anything to the contrary in the Declaration, for a period of one (1) year following the date of the Deed, except only in the event of a Hardship Event released by Seller as provided in paragraph 4 below, Buyer shall not lease and/or sublet the Property or any portion thereof. Any such lease and/or sublet shall be void and unenforceable. All other leases or sublets, including those resulting from such a Hardship Event, shall be subject to the terms and conditions of the Declaration.

4. **Lien Rights Releases.** There is and shall be a lien against the Property to secure Buyer's obligations set forth in this **Exhibit "A"**, which lien may be foreclosed on by Seller if Buyer breaches any of its obligations hereunder. In the event of a proposed sale, transfer, lease or sublet of the Property due to a Hardship Event, Buyer must first provide to Seller evidence of such Hardship Event acceptable to Seller in Seller's sole and absolute discretion, and if acceptable to Seller, Seller shall deliver to Buyer a written acknowledgment of the Hardship Event and waiver of Seller's rights hereunder with respect only to such sale, transfer, lease or sublet. In addition, upon written request from Buyer to Seller and payment of the Gain due to Seller in connection with any sale or transfer of the Property as provided in this **Exhibit "A"**, then Seller shall provide to Buyer a written acknowledgment of such payment and release of Seller's lien rights with respect only to such sale or transfer provided that Buyer provides Seller with evidence satisfactory to Seller in Seller's sole and absolute discretion of the amount of the Gain due, including, without limitation closing or other settlement statements. Any release provided by Seller shall be specific only to the particular sale, transfer, lease or sublet described in the release and not to any subsequent sale, transfer, lease or sublet which shall remain subject to this **Exhibit "A"**.

5. **Binding and Running with Title to the Property.** The covenants, restrictions, agreements and lien rights set forth in this **Exhibit "A"** shall burden and run with title to the Property.

6. **Remedies.** In addition to its right of foreclosure, Seller shall have all remedies at law and/or in equity for a breach by Buyer under this **Exhibit "A"**. In the event that Seller prevails in any action (legal or otherwise) to enforce its rights and/or Buyer's obligations, Seller shall be entitled to recover all of its costs incurred including, without limitation, reasonable attorneys' fees, through and including all appellate levels. By acceptance of the Deed to the Property, Buyer, for itself, and its successors and assigns waives any homestead or other exemption now or hereafter existing or enacted under either Florida or federal law as same may relate to Seller's rights hereunder.

7. **Subordination.** This **Exhibit "A"** shall be subordinate to the right of any holder of an institutional first mortgage on the Property and shall not apply to any sales or leases by an institutional first mortgagee who acquires title to the Property by foreclosure or deed in lieu of foreclosure.

8. **Miscellaneous.** This **Exhibit "A"** shall be construed in accordance with the laws of the State of Florida and shall be binding on Buyer and Buyer's heirs, successors and assigns. In that regard, all references to Buyer in this **Exhibit "A"** shall also mean and refer to each and every of Buyer's heirs, successors and/or assigns. Should any term or provision of this **Exhibit "A"** be ruled to be illegal or otherwise invalid by a court of competent jurisdiction, such term or provision shall be given its nearest legal meaning or be construed as deleted as such court determines, and the same will not invalidate the remaining terms and provisions of this **Exhibit "A"**, which terms, provisions and portions of this Contract will remain in full force and effect. This **Exhibit "A"** may not be amended or modified except by an instrument in writing executed by Seller.



RETURN TO:
NOVA TITLE COMPANY
1401 UNIVERSITY DR. SUITE 402
CORAL SPRINGS, FL 33071-8909
(954) 755-9880

CFN 20060518682
OR BK 20826 PG 1476
RECORDED 09/08/2006 13:31:09
Palm Beach County, Florida
ART 10.00
Doc Stamp 0.70
Sharon R. Bock, CLERK & COMPTROLLER
Pgs 1476 - 1477; (2pgs)

CORRECTIVE

SPECIAL WARRANTY DEED

W/C 84

THIS INDENTURE is made this 5 day of September, 2006, between **BOYNTON BEACH ASSOCIATES XVI, LLLP**, a Florida limited liability limited partnership ("Seller") whose post office address is 1600 Sawgrass Corporate Parkway, Suite 300, Sunrise, Florida 33323, and Jean Bruner Jeanglaude and Gertrude Arthur Jeanglaude, husband and wife ("Buyer"), whose Social Security Numbers are _____ (and and _____, respectively, and whose post office address is 8671 Thornbrook Terrace Point, Boynton Beach, Florida 33437.

WITNESSETH, that Seller, for and in consideration of the sum of **TEN AND NO/100 DOLLARS (\$10.00)** and other good and valuable consideration to Seller in hand paid by Buyer, the receipt and sufficiency of which are hereby acknowledged, has granted, bargained and sold, and hereby grants, bargains and sells to Buyer, and Buyer's heirs, successors, and assigns forever, the following described land, with a Property Appraiser's Identification Number of **00 42 45 32 03 000 1170**.

Lot 117, CANYON ISLES - PLAT TWO, according to the plat thereof, as recorded in Plat Book 40 at Page 43, of the Public Records of Palm Beach County, Florida.

THIS CONVEYANCE AND TITLE TO SAID PROPERTY is subject to: (a) taxes and assessments for the present year and subsequent years, including, but not limited to, pending and certified county or municipal improvement liens; (b) restrictions, reservations, conditions, limitations, easements and other matters of record or imposed by governmental authorities having jurisdiction or control over the subject property, but this reference shall not operate to reimpose any of same; (c) all laws, ordinances, regulations, restrictions, prohibitions and other requirements imposed by governmental authorities, including, but not limited to, all applicable zoning, building, bulkhead, land use and environmental ordinances, rules and regulations, and rights or interests vested in the United States of America and/or the State of Florida; (d) those certain covenants, restrictions, agreements and lien rights set forth in **Exhibit "A"** attached hereto and by this reference made a part hereof; (e) the Declaration of Covenants, Restrictions and Easements for Canyon Isles, dated January 18, 2006 and recorded January 20, 2006 in Official Records Book 19820, at Page 216 of the Public Records of Palm Beach County, Florida, as amended and/or supplemented from time to time; (f) the plat of Canyon Isles - Plat One, as recorded in Plat Book 105, at Page 1 of the Public Records of Palm Beach County, Florida; (g) the plat of Canyon Isles - Plat Two, as recorded in Plat Book 105, at Page 40 of the Public Records of Palm Beach County, Florida; and (h) the plat of Canyon Isles - Plat Three, as recorded in Plat Book 106, at Page 61 of the Public Records of Palm Beach County, Florida.

SELLER does hereby specially warrant the title to said land, subject to the foregoing matters, and will defend same against the lawful claims of all persons claiming by, through or under Seller and no others.

IN WITNESS WHEREOF, Seller has hereunto set Seller's hand and seal the day and year first above written.

WITNESSES:

BOYNTON BEACH ASSOCIATES XVI, LLLP, a Florida limited liability limited partnership

By: **Boynton Beach XVI Corporation**, a Florida corporation, its general partner

By: *N. Maria Menendez*
N. Maria Menendez, Vice President

Kathleen Bronson
Print Name of Witness: Kathleen Bronson

Kathleen M Coffman
Print Name of Witness: Kathleen M Coffman

STATE OF FLORIDA
COUNTY OF BROWARD

The foregoing instrument was acknowledged before me this 5 day of September, 2006, by N. Maria Menendez, as Vice President of Boynton Beach XVI Corporation, a Florida corporation, the general partner of Boynton Beach Associates XVI, LLLP, a Florida limited liability limited partnership, on behalf of said corporation and limited liability limited partnership. She is personally known to me.

Kathleen M Coffman
Notary Public
My Commission Expires:

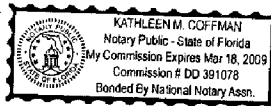

This instrument prepared by:
HENRY W. JOHNSON, ESQ.
HUME & JOHNSON, P.A.
1401 University Drive, #301
Coral Springs, Florida 33071
(954) 755-9880

THIS DEED IS BEING RECORDED TO CORRECT THE LEGAL DESCRIPTION CONTAINED IN THE ORIGINAL DEED DATED 08/03/06 AND RECORDED 08/08/06 IN OFFICIAL RECORDS BOOK 20706 AT PAGE 325 OF THE PUBLIC RECORDS OF PALM BEACH COUNTY, FLORIDA

EXHIBIT "A"
COVENANTS, RESTRICTIONS, AGREEMENTS AND LIEN RIGHTS

The title to the property described in the Special Warranty Deed to which this **Exhibit "A"** is attached (the "Deed") shall be subject to and burdened by the covenants, restrictions, agreements and lien rights set forth below:

1. **Capitalized Terms and Definitions.** All initial capitalized terms used in this **Exhibit "A"** but not defined herein shall have the meanings given to such terms as set forth in the Deed. The following terms as used in this **Exhibit "A"** shall have the meanings given to such terms as set forth below.

"**Gain**" shall mean and refer to the amount, if any, by which: (i) the gross selling price of the Property (less and except: (y) the actual, documented costs of any physical improvements made by Buyer after the date of the Deed to the exterior of the home on the Property such as pools, patios, screen enclosures and extensions, and (z) the actual, documented closing costs required to be paid by Buyer in connection with the sale of the Property such as documentary stamp taxes, recording fees and/or brokerage commissions), exceeds (ii) the "Total Purchase Price" paid to Seller by Buyer pursuant to and as defined in the Purchase Contract executed by Seller and Buyer.

"**Hardship Event**" shall mean and refer to a sale, transfer, lease or sublet of the Property, as appropriate, following a divorce of the Buyers (if married to each other), death or serious disability of one or more of the Buyers, job transfer of one or more of the Buyers to a location greater than fifty (50) miles from the Property, or other reason acceptable to Seller in Seller's sole and absolute discretion, as evidenced by a written waiver of this provision given by Seller.

"**Property**" shall mean and refer to the property described in the Deed together with the improvements thereon.

"**Transfer Advertisement or Agreement**" shall mean and refer to any or all of the following: (i) any listing or advertisement for the sale or lease of the Property or any portion thereof made with a broker, in any multiple listing service, in any classified or other advertisement, or otherwise (including, without limitation, "by owner"), (ii) any agreement (verbal or written) for transfer of title to the Property to any third party, and/or (iii) any agreement (verbal or written) for the leasing and/or subletting of the Property or any portion thereof, notwithstanding anything to the contrary in the Declaration.

2. **Sales/Transfers of the Property.** In the event that Buyer sells or transfers title to the Property (directly or indirectly): (a) at any time within one (1) year following the date of the Deed, and/or (b) at any time thereafter if such sale or transfer results from a Transfer Advertisement or Agreement made or entered into within one (1) year following the date of the Deed, then except only in the event of a Hardship Event released by Seller as provided in Paragraph 4 below, Buyer shall pay to Seller from the proceeds of such sale or transfer, an amount equal to one-hundred percent (100%) of the **Gain** realized from such sale or transfer.

3. **No Leasing of the Property.** Notwithstanding anything to the contrary in the Declaration, for a period of one (1) year following the date of the Deed, except only in the event of a Hardship Event released by Seller as provided in paragraph 4 below, Buyer shall not lease and/or sublet the Property or any portion thereof. Any such lease and/or sublet shall be void and unenforceable. All other leases or sublets, including those resulting from such a Hardship Event, shall be subject to the terms and conditions of the Declaration.

4. **Lien Rights: Releases.** There is and shall be a lien against the Property to secure Buyer's obligations set forth in this **Exhibit "A"**, which lien may be foreclosed on by Seller if Buyer breaches any of its obligations hereunder. In the event of a proposed sale, transfer, lease or sublet of the Property due to a Hardship Event, Buyer must first provide to Seller evidence of such Hardship Event acceptable to Seller in Seller's sole and absolute discretion, and if acceptable to Seller, Seller shall deliver to Buyer a written acknowledgment of the Hardship Event and waiver of Seller's rights hereunder with respect only to such sale, transfer, lease or sublet. In addition, upon written request from Buyer to Seller and payment of the **Gain** due to Seller in connection with any sale or transfer of the Property as provided in this **Exhibit "A"**, then Seller shall provide to Buyer a written acknowledgment of such payment and release of Seller's lien rights with respect only to such sale or transfer provided that Buyer provides Seller with evidence satisfactory to Seller in Seller's sole and absolute discretion of the amount of the **Gain** due, including, without limitation closing or other settlement statements. Any release provided by Seller shall be specific only to the particular sale, transfer, lease or sublet described in the release and not to any subsequent sale, transfer, lease or sublet which shall remain subject to this **Exhibit "A"**.

5. **Binding and Running with Title to the Property.** The covenants, restrictions, agreements and lien rights set forth in this **Exhibit "A"** shall burden and run with title to the Property.

6. **Remedies.** In addition to its right of foreclosure, Seller shall have all remedies at law and/or in equity for a breach by Buyer under this **Exhibit "A"**. In the event that Seller prevails in any action (legal or otherwise) to enforce its rights and/or Buyer's obligations, Seller shall be entitled to recover all of its costs incurred including, without limitation, reasonable attorneys' fees, through and including all appellate levels. By acceptance of the Deed to the Property, Buyer, for itself, and its successors and assigns waives any homestead or other exemption now or hereafter existing or enacted under either Florida or federal law as same may relate to Seller's rights hereunder.

7. **Subordination.** This **Exhibit "A"** shall be subordinate to the right of any holder of an institutional first mortgage on the Property and shall not apply to any sales or leases by an institutional first mortgagee who acquires title to the Property by foreclosure or deed in lieu of foreclosure.

8. **Miscellaneous.** This **Exhibit "A"** shall be construed in accordance with the laws of the State of Florida and shall be binding on Buyer and Buyer's heirs, successors and assigns. In that regard, all references to Buyer in this **Exhibit "A"** shall also mean and refer to each and every of Buyer's heirs, successors and/or assigns. Should any term or provision of this **Exhibit "A"** be ruled to be illegal or otherwise invalid by a court of competent jurisdiction, such term or provision shall be given its nearest legal meaning or be construed as deleted as such court determines, and the same will not invalidate the remaining terms and provisions of this **Exhibit "A"**, which terms, provisions and portions of this Contract will remain in full force and effect. This **Exhibit "A"** may not be amended or modified except by an instrument in writing executed by Seller.



RETURN TO:
NOVA TITLE COMPANY
1401 UNIVERSITY DR. SUITE 402
CORAL SPRINGS, FL 33071-8908
(954) 755-9889

CFN 20060567208
OR BK 20927 PG 0647
RECORDED 10/04/2006 12:56:16
Palm Beach County, Florida
AMT 10.00
Doc Stamp 0.70
Sharon K. Beck, CLERK & COMPTROLLER
Pgs 0647 - 648; (2pgs)

CORRECTIVE

SPECIAL WARRANTY DEED

W/C
84

THIS INDENTURE is made this 25 day of September, 2006, between **BOYNTON BEACH ASSOCIATES XVI, LLLP**, a Florida limited liability limited partnership ("Seller") whose post office address is 1600 Sawgrass Corporate Parkway, Suite 300, Sunrise, Florida 33323, and Jean Bruner Jeanglaude and Gertrude Arthur Jeanglaude, husband and wife ("Buyer"), whose Social Security Numbers are _____ and _____, respectively, and whose post office address is 8671 Thornbrook Terrace Point, Boynton Beach, Florida 33437.

WITNESSETH, that Seller, for and in consideration of the sum of TEN AND NO/100 DOLLARS (\$10.00) and other good and valuable consideration to Seller in hand paid by Buyer, the receipt and sufficiency of which are hereby acknowledged, has granted, bargained and sold, and hereby grants, bargains and sells to Buyer, and Buyer's heirs, successors and assigns forever, the following described land, with a Property Appraiser's Identification Number of 00424532030001170.

Lot 117, CANYON ISLES - PLAT TWO, according to the plat thereof, as recorded in Plat Book 105 at Page 40, of the Public Records of Palm Beach County, Florida.

THIS CONVEYANCE AND TITLE TO SAID PROPERTY is subject to: (a) taxes and assessments for the present year and subsequent years, including, but not limited to, pending and certified county or municipal improvement liens; (b) restrictions, reservations, conditions, limitations, easements and other matters of record or imposed by governmental authorities having jurisdiction or control over the subject property, but this reference shall not operate to reimpose any of same; (c) all laws, ordinances, regulations, restrictions, prohibitions and other requirements imposed by governmental authorities, including, but not limited to, all applicable zoning, building, bulkhead, land use and environmental ordinances, rules and regulations, and rights or interests vested in the United States of America and/or the State of Florida; (d) those certain covenants, restrictions, agreements and lien rights set forth in Exhibit "A" attached hereto and by this reference made a part hereof; (e) the Declaration of Covenants, Restrictions and Easements for Canyon Isles, dated January 18, 2006 and recorded January 20, 2006 in Official Records Book 19820, at Page 216 of the Public Records of Palm Beach County, Florida, as amended and/or supplemented from time to time; (f) the plat of Canyon Isles - Plat One, as recorded in Plat Book 105, at Page 1 of the Public Records of Palm Beach County, Florida; (g) the plat of Canyon Isles - Plat Two, as recorded in Plat Book 105, at Page 40 of the Public Records of Palm Beach County, Florida; and (h) the plat of Canyon Isles - Plat Three, as recorded in Plat Book 106, at Page 61 of the Public Records of Palm Beach County, Florida.

SELLER does hereby specially warrant the title to said land, subject to the foregoing matters, and will defend same against the lawful claims of all persons claiming by, through or under Seller and no others.

IN WITNESS WHEREOF, Seller has hereunto set Seller's hand and seal the day and year first above written.

WITNESSES:

BOYNTON BEACH ASSOCIATES XVI, LLLP, a Florida limited liability limited partnership

By: Boynton Beach XVI Corporation, a Florida corporation, its general partner

By: N. Maria Menendez
N. Maria Menendez, Vice President

Alamy D...
Print Name of Witness: Alamy D...

Kathleen M Coffman
Print Name of Witness: Kathleen M Coffman

STATE OF FLORIDA
COUNTY OF BROWARD

The foregoing instrument was acknowledged before me this 25 day of September, 2006, by N. Maria Menendez, as Vice President of Boynton Beach XVI Corporation, a Florida corporation, the general partner of Boynton Beach Associates XVI, LLLP, a Florida limited liability limited partnership, on behalf of said corporation and limited liability limited partnership. She is personally known to me.

Kathleen M Coffman
Notary Public
My Commission Expires:



This instrument prepared by:
HENRY W. JOHNSON, ESQ.
HUME & JOHNSON, P.A.
1401 University Drive, #301
Coral Springs, Florida 33071
(954) 755-9880

THIS DEED IS BEING RECORDED TO CORRECT THE LEGAL DESCRIPTION CONTAINED IN THE CORRECTIVE DEED DATED SEPTEMBER 5, 2006 AND RECORDED SEPTEMBER 8, 2006 in ORBOOK 20826 AT PAGE 1476 OF THE PUBLIC RECORDS OF PALM BEACH COUNTY, FLORIDA

EXHIBIT "A"
COVENANTS, RESTRICTIONS, AGREEMENTS AND LIEN RIGHTS

The title to the property described in the Special Warranty Deed to which this **Exhibit "A"** is attached (the "Deed") shall be subject to and burdened by the covenants, restrictions, agreements and lien rights set forth below:

1. **Capitalized Terms and Definitions.** All initial capitalized terms used in this **Exhibit "A"** but not defined herein shall have the meanings given to such terms as set forth in the Deed. The following terms as used in this **Exhibit "A"** shall have the meanings given to such terms as set forth below.

"**Gain**" shall mean and refer to the amount, if any, by which: (i) the gross selling price of the Property (less and except: (y) the actual, documented costs of any physical improvements made by Buyer after the date of the Deed to the exterior of the home on the Property such as pools, patios, screen enclosures and extensions, and (z) the actual, documented closing costs required to be paid by Buyer in connection with the sale of the Property such as documentary stamp taxes, recording fees and/or brokerage commissions), exceeds (ii) the "Total Purchase Price" paid to Seller by Buyer pursuant to and as defined in the Purchase Contract executed by Seller and Buyer.

"**Hardship Event**" shall mean and refer to a sale, transfer, lease or sublet of the Property, as appropriate, following a divorce of the Buyers (if married to each other), death or serious disability of one or more of the Buyers, job transfer of one or more of the Buyers to a location greater than fifty (50) miles from the Property, or other reason acceptable to Seller in Seller's sole and absolute discretion, as evidenced by a written waiver of this provision given by Seller.

"**Property**" shall mean and refer to the property described in the Deed together with the improvements thereon.

"**Transfer Advertisement or Agreement**" shall mean and refer to any or all of the following: (i) any listing or advertisement for the sale or lease of the Property or any portion thereof made with a broker, in any multiple listing service, in any classified or other advertisement, or otherwise (including, without limitation, "by owner"), (ii) any agreement (verbal or written) for transfer of title to the Property to any third party, and/or (iii) any agreement (verbal or written) for the leasing and/or subletting of the Property or any portion thereof, notwithstanding anything to the contrary in the Declaration.

2. **Sales/Transfers of the Property.** In the event that Buyer sells or transfers title to the Property (directly or indirectly): (a) at any time within one (1) year following the date of the Deed, and/or (b) at any time thereafter if such sale or transfer results from a Transfer Advertisement or Agreement made or entered into within one (1) year following the date of the Deed, then except only in the event of a Hardship Event released by Seller as provided in Paragraph 4 below, Buyer shall pay to Seller from the proceeds of such sale or transfer, an amount equal to one-hundred percent (100%) of the Gain realized from such sale or transfer.

3. **No Leasing of the Property.** Notwithstanding anything to the contrary in the Declaration, for a period of one (1) year following the date of the Deed, except only in the event of a Hardship Event released by Seller as provided in paragraph 4 below, Buyer shall not lease and/or sublet the Property or any portion thereof. Any such lease and/or sublet shall be void and unenforceable. All other leases or sublets, including those resulting from such a Hardship Event, shall be subject to the terms and conditions of the Declaration.

4. **Lien Rights: Releases.** There is and shall be a lien against the Property to secure Buyer's obligations set forth in this **Exhibit "A"**, which lien may be foreclosed on by Seller if Buyer breaches any of its obligations hereunder. In the event of a proposed sale, transfer, lease or sublet of the Property due to a Hardship Event, Buyer must first provide to Seller evidence of such Hardship Event acceptable to Seller in Seller's sole and absolute discretion, and if acceptable to Seller, Seller shall deliver to Buyer a written acknowledgment of the Hardship Event and waiver of Seller's rights hereunder with respect only to such sale, transfer, lease or sublet. In addition, upon written request from Buyer to Seller and payment of the Gain due to Seller in connection with any sale or transfer of the Property as provided in this **Exhibit "A"**, then Seller shall provide to Buyer a written acknowledgment of such payment and release of Seller's lien rights with respect only to such sale or transfer provided that Buyer provides Seller with evidence satisfactory to Seller in Seller's sole and absolute discretion of the amount of the Gain due, including, without limitation closing or other settlement statements. Any release provided by Seller shall be specific only to the particular sale, transfer, lease or sublet described in the release and not to any subsequent sale, transfer, lease or sublet which shall remain subject to this **Exhibit "A"**.

5. **Binding and Running with Title to the Property.** The covenants, restrictions, agreements and lien rights set forth in this **Exhibit "A"** shall burden and run with title to the Property.

6. **Remedies.** In addition to its right of foreclosure, Seller shall have all remedies at law and/or in equity for a breach by Buyer under this **Exhibit "A"**. In the event that Seller prevails in any action (legal or otherwise) to enforce its rights and/or Buyer's obligations, Seller shall be entitled to recover all of its costs incurred including, without limitation, reasonable attorneys' fees, through and including all appellate levels. By acceptance of the Deed to the Property, Buyer, for itself, and its successors and assigns waives any homestead or other exemption now or hereafter existing or enacted under either Florida or federal law as same may relate to Seller's rights hereunder.

7. **Subordination.** This **Exhibit "A"** shall be subordinate to the right of any holder of an institutional first mortgage on the Property and shall not apply to any sales or leases by an institutional first mortgagee who acquires title to the Property by foreclosure or deed in lieu of foreclosure.

8. **Miscellaneous.** This **Exhibit "A"** shall be construed in accordance with the laws of the State of Florida and shall be binding on Buyer and Buyer's heirs, successors and assigns. In that regard, all references to Buyer in this **Exhibit "A"** shall also mean and refer to each and every of Buyer's heirs, successors and/or assigns. Should any term or provision of this **Exhibit "A"** be ruled to be illegal or otherwise invalid by a court of competent jurisdiction, such term or provision shall be given its nearest legal meaning or be construed as deleted as such court determines, and the same will not invalidate the remaining terms and provisions of this **Exhibit "A"**, which terms, provisions and portions of this Contract will remain in full force and effect. This **Exhibit "A"** may not be amended or modified except by an instrument in writing executed by Seller.



RETURN TO:
 NUX & FINANCIAL COMPANY
 1401 UNIVERSITY DRIVE SUITE 402
 CORAL SPRINGS, FL 33071-3908
 (954) 756-8800
 This instrument prepared by:
 John Hume, Esq.
 Hume & Johnson P.A.
 1401 University Drive, Suite 402
 Coral Springs, Florida 33071

CFN 20060567209
 OR BK 20927 PG 0649
 RECORDED 10/04/2006 12:56:16
 Palm Beach County, Florida
 Sharon R. Bock, CLERK & COMPTROLLER
 Pg 0649; (1pg)

W/MC 84

CORRECTION AND RATIFICATION AGREEMENT

AGREEMENT made this 26 day of 09/10/06, by JEAN BRUNER JEANGLAUBE AND GERTRUDE ARTHUR JEANGLAUBE, husband and wife ("Borrowers"), whose post office address is 8671 Thornbrook Terrace Point, BOYNTON BEACH, FLORIDA 33437.

Recitals:

- A. Borrowers are the owners of the real property located at , 8671 Thornbrook Terrace Point Boynton Beach, Florida 33437 more particularly described as follows: Lot 117, CANYON ISLES PLAT TWO, according to the plat thereof, as recorded in Plat Book 105 at Page 40 of the Public Records of Palm Beach County, Florida
- B. Borrowers acquired title to the property by Warranty Deed dated September 5, 2006 and recorded September 8, 2006 in Official Records Book 20826 at Page 1476 of the Public Records of Palm Beach County, Florida.
- C. In conjunction with their purchase of the property, Borrowers encumbered the property with a mortgage in favor of GL FINANCIAL SERVICES, LLC., which mortgage secured a loan in the amount of \$650,000.00. The mortgage was dated August 3, 2006 and recorded August 8, 2006 in Official Records Book 20706 at Page 0327 of the Public Records of Palm Beach County, Florida.

D. RECORDED WITH INCORRECT LEGAL DESCRIPTION

THEREFORE, in consideration of the original mortgage loan and for other good and valuable considerations, the receipt of which is hereby acknowledged, Borrowers agree as follows:

- 1. Recitals. The above recitals are true and correct.
- 2. Correction. (INCORRECT LEGAL DESCRIPTION):

3. Ratification. Except as otherwise modified herein, all of the original terms and provisions of the mortgage are hereby ratified and confirmed and incorporated herein by reference.

Witnesses:

Ella Katz
 Ella Katz
PRINTED NAME OF WITNESS
Mary Laboul
 Mary Laboul
PRINTED NAME OF WITNESS

Jean Bruner Jeanglaube
 JEAN BRUNER JEANGLAUBE
Gertrude Arthur Jeanglaube
 GERTRUDE ARTHUR JEANGLAUBE

STATE OF FLORIDA
 COUNTY OF BROWARD

The foregoing instrument was acknowledged before me this 26 day of September, 2006 by JEAN BRUNER JEANGLAUBE AND GERTRUDE ARTHUR JEANGLAUBE, who are personally known to me or produced drivers licenses as identification.

My commission expires: _____
 Notary Public, State of Florida

 Maureen E. Roxberry
 Commission #DD299658
 Expires: Mar 11, 2008
 Bonded Thru
 Atlantic Bonding Co., Inc.



CORAL SPRINGS, FL 33071-3900
(954) 776-0880

CFN 20060567210
CR BK 20927 PG 0650
RECORDED 10/04/2006 12:56:16
Palm Beach County, Florida
Sharon R. Hock, CLERK & COMPTROLLER
Pg 0650; (1pg)

This instrument prepared by:
John Hume, Esq.
Hume & Johnson P.A.
1401 University Drive, Suite 402
Coral Springs, Florida 33071

W/C 84

CORRECTION AND RATIFICATION AGREEMENT

AGREEMENT made this 26 day of 09/06 by JEAN BRUNER JEANGLAUBE AND GERTRUDE ARTHUR JEANGLAUBE, husband and wife ("Borrowers"), whose post office address is 8671 Thornbrook Terrace Point, BOYNTON BEACH, FLORIDA 33437.

Recitals:

A. Borrowers are the owners of the real property located at , 8671 Thornbrook Terrace Point Boynton Beach, Florida 33437 more particularly described as follows: Lot 117, CANYON ISLES PLAT W/C, according to the plat thereof, as recorded in Plat Book 105 at Page 40 of the Public Records of Palm Beach County, Florida

B. Borrowers acquired title to the property by Warranty Deed dated September 5, 2006 and recorded September 8, 2006 in Official Records Book 20826 at Page 1476 of the Public Records of Palm Beach County, Florida.

C. In conjunction with their purchase of the property, Borrowers encumbered the property with a mortgage in favor of GL FINANCIAL SERVICES, LLC., which mortgage secured a loan in the amount of \$141,120.00. The mortgage was dated August 3, 2006 and recorded August 8, 2006 in Official Records Book 20706 at Page 0344 of the Public Records of Palm Beach County, Florida.

D. RECORDED WITH INCORRECT LEGAL DESCRIPTION

THEREFORE, in consideration of the original mortgage loan and for other good and valuable considerations, the receipt of which is hereby acknowledged, Borrowers agree as follows:

1. Recitals. The above recitals are true and correct.
2. Correction. (INCORRECT LEGAL DESCRIPTION):
3. Ratification. Except as otherwise modified herein, all of the original terms and provisions of the mortgage are hereby ratified and confirmed and incorporated herein by reference.

Witnesses:

Ella Katz
Ella Katz
PRINTED NAME OF WITNESS

Mary Campbell
Mary Campbell
PRINTED NAME OF WITNESS

Jean Bruner Jeanglaube
JEAN BRUNER JEANGLAUBE

Gertrude Arthur Jeanglaube
GERTRUDE ARTHUR JEANGLAUBE

STATE OF FLORIDA
COUNTY OF BROWARD

The foregoing instrument was acknowledged before me this 26th day of September, 2006 by JEAN BRUNER JEANGLAUBE AND GERTRUDE ARTHUR JEANGLAUBE, who are personally known to me or produced drivers license as identification.

My commission expires:

Maureen E. Roxberry
Commission #DD299658
Expires: Mar 11, 2008
Bonded Thru
Atlantic Bonding Co., Inc.

[Signature]
Notary Public, State of Florida



2

MVC 84

After Recording Return To:
 COUNTRYWIDE HOME LOANS, INC.
 MS SV-79 DOCUMENT PROCESSING
 P.O.Box 10423
 Van Nuys, CA 91410-0423
 This document was prepared by:
 YVETTE ZAPATA
 GL FINANCIAL SERVICES, LLC.

NOVA TITLE COMPANY
 1401 UNIVERSITY DR. STE 300
 CORAL SPRINGS, FL 33071
 (954) 756-9889

CFN 20060462328
 DR BK 20706 PG 0327
 RECORDED 08/08/2006 15:46:06
 Palm Beach County, Florida
 AMT 650,000.00
 Debt Doc 2,275.00
 Intang 1,300.00
 Sharon R. Bock, CLERK & COMPTROLLER
 Pgs 0327 - 343; (17pgs)

210 N. UNIVERSITY DR STE 601
 CORAL SPRINGS, FL 33071

[Space Above This Line For Recording Data]

00013884537607006
 (Doc ID #)

MORTGAGE

MIN 1000157-0006863972-9

DEFINITIONS

Words used in multiple sections of this document are defined below and other words are defined in Sections 3, 11, 13, 18, 20 and 21. Certain rules regarding the usage of words used in this document are also provided in Section 16.

- (A) "Security Instrument" means this document, which is dated AUGUST 03, 2006, together with all Riders to this document.
- (B) "Borrower" is
 JEAN B JEANGLAUDE, AND GERTRUDE ARTHUR-JEANGLAUDE, HUSBAND AND WIFE

Borrower is the mortgagor under this Security Instrument.

(C) "MERS" is Mortgage Electronic Registration Systems, Inc. MERS is a separate corporation that is acting solely as a nominee for Lender and Lender's successors and assigns. MERS is the mortgagee under this Security Instrument. MERS is organized and existing under the laws of Delaware, and has an address and telephone number of P.O. Box 2026, Flint, MI 48501-2026, tel. (888) 679-MERS.

(D) "Lender" is
 GL FINANCIAL SERVICES, LLC.

Lender is a BANK
 organized and existing under the laws of FLORIDA
 Lender's address is
 210 N. UNIVERSITY DR STE 601, CORAL SPRINGS, FL 33071

(E) "Note" means the promissory note signed by Borrower and dated AUGUST 03, 2006. The Note states that Borrower owes Lender
 SIX HUNDRED FIFTY THOUSAND and 00/100

Dollars (U.S. \$ 650,000.00) plus interest. Borrower has promised to pay this debt in regular Periodic Payments and to pay the debt in full not later than SEPTEMBER 01, 2036.

(F) "Property" means the property that is described below under the heading "Transfer of Rights in the Property."

FLORIDA-Single Family Fannie Mae/Freddie Mac UNIFORM INSTRUMENT WITH MERS

Page 1 of 11

GA(FL) (0005) CHL (08/05)(d) VMP Mortgage Solutions, Inc. (800)521-7291
 CONV/VA

Form 3010 1/01



* 2 3 9 9 1 *

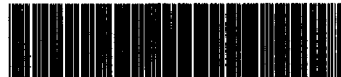

* 1 3 8 8 4 5 3 7 6 0 0 0 0 2 0 0 6 A *

This document is a legal document and should be read carefully.

DOC ID #: 00013884537607006

(G) "Loan" means the debt evidenced by the Note, plus interest, any prepayment charges and late charges due under the Note, and all sums due under this Security Instrument, plus interest.

(H) "Riders" means all Riders to this Security Instrument that are executed by Borrower. The following Riders are to be executed by Borrower [check box as applicable]:

- | | | |
|--|--|---|
| <input type="checkbox"/> Adjustable Rate Rider | <input type="checkbox"/> Condominium Rider | <input checked="" type="checkbox"/> Second Home Rider |
| <input type="checkbox"/> Balloon Rider | <input checked="" type="checkbox"/> Planned Unit Development Rider | <input type="checkbox"/> 1-4 Family Rider |
| <input type="checkbox"/> VA Rider | <input type="checkbox"/> Biweekly Payment Rider | <input type="checkbox"/> Other(s) [specify] |

(I) "Applicable Law" means all controlling applicable federal, state and local statutes, regulations, ordinances and administrative rules and orders (that have the effect of law) as well as all applicable final, non-appealable judicial opinions.

(J) "Community Association Dues, Fees, and Assessments" means all dues, fees, assessments and other charges that are imposed on Borrower or the Property by a condominium association, homeowners association or similar organization.

(K) "Electronic Funds Transfer" means any transfer of funds, other than a transaction originated by check, draft, or similar paper instrument, which is initiated through an electronic terminal, telephonic instrument, computer, or magnetic tape so as to order, instruct, or authorize a financial institution to debit or credit an account. Such term includes, but is not limited to, point-of-sale transfers, automated teller machine transactions, transfers initiated by telephone, wire transfers, and automated clearinghouse transfers.

(L) "Escrow Items" means those items that are described in Section 3.

(M) "Miscellaneous Proceeds" means any compensation, settlement, award of damages, or proceeds paid by any third party (other than insurance proceeds paid under the coverages described in Section 5) for: (i) damage to, or destruction of, the Property; (ii) condemnation or other taking of all or any part of the Property; (iii) conveyance in lieu of condemnation; or (iv) misrepresentations of, or omissions as to, the value and/or condition of the Property.

(N) "Mortgage Insurance" means insurance protecting Lender against the nonpayment of, or default on, the Loan.

(O) "Periodic Payment" means the regularly scheduled amount due for (i) principal and interest under the Note, plus (ii) any amounts under Section 3 of this Security Instrument.

(P) "RESPA" means the Real Estate Settlement Procedures Act (12 U.S.C. Section 2601 et seq.) and its implementing regulation, Regulation X (24 C.F.R. Part 3500), as they might be amended from time to time, or any additional or successor legislation or regulation that governs the same subject matter. As used in this Security Instrument, "RESPA" refers to all requirements and restrictions that are imposed in regard to a "federally related mortgage loan" even if the Loan does not qualify as a "federally related mortgage loan" under RESPA.

(Q) "Successor in Interest of Borrower" means any party that has taken title to the Property, whether or not that party has assumed Borrower's obligations under the Note and/or this Security Instrument.

TRANSFER OF RIGHTS IN THE PROPERTY

This Security Instrument secures to Lender: (i) the repayment of the Loan, and all renewals, extensions and modifications of the Note; and (ii) the performance of Borrower's covenants and agreements under this Security Instrument and the Note. For this purpose, Borrower does hereby mortgage, grant and convey to MERS (solely as nominee for Lender and Lender's successors and assigns) and to the successors and assigns of MERS, the following described property located in the

COUNTY of PALM BEACH :
[Type of Recording Jurisdiction] [Name of Recording Jurisdiction]

SEE EXHIBIT "A" ATTACHED HERETO AND MADE A PART HEREOF.

THIS INSTRUMENT IS FILED WITH THE PUBLIC RECORDS OFFICE OF DADE COUNTY, FLORIDA

DOC ID #: 00013884537607006

Parcel ID Number: 8671 THORNBROOK TERRACE POINT, Boynton Beach
[Street/City]

Florida 33437-4882 ("Property Address"):
[Zip Code]

TOGETHER WITH all the improvements now or hereafter erected on the property, and all easements, appurtenances, and fixtures now or hereafter a part of the property. All replacements and additions shall also be covered by this Security Instrument. All of the foregoing is referred to in this Security Instrument as the "Property." Borrower understands and agrees that MERS holds only legal title to the interests granted by Borrower in this Security Instrument, but, if necessary to comply with law or custom, MERS (as nominee for Lender and Lender's successors and assigns) has the right to exercise any or all of those interests, including, but not limited to, the right to foreclose and sell the Property; and to take any action required of Lender including, but not limited to, releasing and canceling this Security Instrument.

BORROWER COVENANTS that Borrower is lawfully seized of the estate hereby conveyed and has the right to mortgage, grant and convey the Property and that the Property is unencumbered, except for encumbrances of record. Borrower warrants and will defend generally the title to the Property against all claims and demands, subject to any encumbrances of record.

THIS SECURITY INSTRUMENT combines uniform covenants for national use and non-uniform covenants with limited variations by jurisdiction to constitute a uniform security instrument covering real property.

UNIFORM COVENANTS. Borrower and Lender covenant and agree as follows:

1. **Payment of Principal, Interest, Escrow Items, Prepayment Charges, and Late Charges.** Borrower shall pay when due the principal of, and interest on, the debt evidenced by the Note and any prepayment charges and late charges due under the Note. Borrower shall also pay funds for Escrow Items pursuant to Section 3. Payments due under the Note and this Security Instrument shall be made in U.S. currency. However, if any check or other instrument received by Lender as payment under the Note or this Security Instrument is returned to Lender unpaid, Lender may require that any or all subsequent payments due under the Note and this Security Instrument be made in one or more of the following forms, as selected by Lender: (a) cash; (b) money order; (c) certified check, bank check, treasurer's check or cashier's check, provided any such check is drawn upon an institution whose deposits are insured by a federal agency, instrumentality, or entity; or (d) Electronic Funds Transfer.

Payments are deemed received by Lender when received at the location designated in the Note or at such other location as may be designated by Lender in accordance with the notice provisions in Section 15. Lender may return any payment or partial payment if the payment or partial payments are insufficient to bring the Loan current. Lender may accept any payment or partial payment insufficient to bring the Loan current, without waiver of any rights hereunder or prejudice to its rights to refuse such payment or partial payments in the future, but Lender is not obligated to apply such payments at the time such payments are accepted. If each Periodic Payment is applied as of its scheduled due date, then Lender need not pay interest on unapplied funds. Lender may hold such unapplied funds until Borrower makes payment to bring the Loan current. If Borrower does not do so within a reasonable period of time, Lender shall either apply such funds or return them to Borrower. If not applied earlier, such funds will be applied to the outstanding principal balance under the Note immediately prior to foreclosure. No offset or claim which Borrower might have now or in the future against Lender shall relieve Borrower from making payments due under the Note and this Security Instrument or performing the covenants and agreements secured by this Security Instrument.

2. **Application of Payments or Proceeds.** Except as otherwise described in this Section 2, all payments accepted and applied by Lender shall be applied in the following order of priority: (a) interest due under the Note; (b) principal due under the Note; (c) amounts due under Section 3. Such payments shall be applied to each Periodic Payment in the order in which it became due. Any remaining amounts shall be applied first to late charges, second to any other amounts due under this Security Instrument, and then to reduce the principal balance of the Note.

If Lender receives a payment from Borrower for a delinquent Periodic Payment which includes a sufficient amount to pay any late charge due, the payment may be applied to the delinquent payment and the late charge. If more than one Periodic Payment is outstanding, Lender may apply any payment received from Borrower to the repayment of the Periodic Payments if, and to the extent that, each payment can be paid in full. To the extent that any excess exists after the payment is applied to the full payment of one or more Periodic Payments, such excess may be applied to any late charges due. Voluntary prepayments shall be applied first to any prepayment charges and then as described in the Note.

THIS

DOC ID #: 00013884537607006

Any application of payments, insurance proceeds, or Miscellaneous Proceeds to principal due under the Note shall not extend or postpone the due date, or change the amount, of the Periodic Payments.

3. Funds for Escrow Items. Borrower shall pay to Lender on the day Periodic Payments are due under the Note, until the Note is paid in full, a sum (the "Funds") to provide for payment of amounts due for: (a) taxes and assessments and other items which can attain priority over this Security Instrument as a lien or encumbrance on the Property; (b) leasehold payments or ground rents on the Property, if any; (c) premiums for any and all insurance required by Lender under Section 5; and (d) Mortgage Insurance premiums, if any, or any sums payable by Borrower to Lender in lieu of the payment of Mortgage Insurance premiums in accordance with the provisions of Section 10. These items are called "Escrow Items." At origination or at any time during the term of the Loan, Lender may require that Community Association Dues, Fees, and Assessments, if any, be escrowed by Borrower, and such dues, fees and assessments shall be an Escrow Item. Borrower shall promptly furnish to Lender all notices of amounts to be paid under this Section. Borrower shall pay Lender the Funds for Escrow Items unless Lender waives Borrower's obligation to pay the Funds for any or all Escrow Items. Lender may waive Borrower's obligation to pay to Lender Funds for any or all Escrow Items at any time. Any such waiver may only be in writing. In the event of such waiver, Borrower shall pay directly, when and where payable, the amounts due for any Escrow Items for which payment of Funds has been waived by Lender and, if Lender requires, shall furnish to Lender receipts evidencing such payment within such time period as Lender may require. Borrower's obligation to make such payments and to provide receipts shall for all purposes be deemed to be a covenant and agreement contained in this Security Instrument, as the phrase "covenant and agreement" is used in Section 9. If Borrower is obligated to pay Escrow Items directly, pursuant to a waiver, and Borrower fails to pay the amount due for an Escrow Item, Lender may exercise its rights under Section 9 and pay such amount and Borrower shall then be obligated under Section 9 to repay to Lender any such amount. Lender may revoke the waiver as to any or all Escrow Items at any time by a notice given in accordance with Section 15 and, upon such revocation, Borrower shall pay to Lender all Funds, and in such amounts, that are then required under this Section 3.

Lender may, at any time, collect and hold Funds in an amount (a) sufficient to permit Lender to apply the Funds at the time specified under RESPA, and (b) not to exceed the maximum amount a lender can require under RESPA. Lender shall estimate the amount of Funds due on the basis of current data and reasonable estimates of expenditures of future Escrow Items or otherwise in accordance with Applicable Law.

The Funds shall be held in an institution whose deposits are insured by a federal agency, instrumentality, or entity (including Lender, if Lender is an institution whose deposits are so insured) or in any Federal Home Loan Bank. Lender shall apply the Funds to pay the Escrow Items no later than the time specified under RESPA. Lender shall not charge Borrower for holding and applying the Funds, annually analyzing the escrow account, or verifying the Escrow Items, unless Lender pays Borrower interest on the Funds and Applicable Law permits Lender to make such a charge. Unless an agreement is made in writing or Applicable Law requires interest to be paid on the Funds, Lender shall not be required to pay Borrower any interest or earnings on the Funds. Borrower and Lender can agree in writing, however, that interest shall be paid on the Funds. Lender shall give to Borrower, without charge, an annual accounting of the Funds as required by RESPA.

If there is a surplus of Funds held in escrow, as defined under RESPA, Lender shall account to Borrower for the excess funds in accordance with RESPA. If there is a shortage of Funds held in escrow, as defined under RESPA, Lender shall notify Borrower as required by RESPA, and Borrower shall pay to Lender the amount necessary to make up the shortage in accordance with RESPA, but in no more than 12 monthly payments. If there is a deficiency of Funds held in escrow, as defined under RESPA, Lender shall notify Borrower as required by RESPA, and Borrower shall pay to Lender the amount necessary to make up the deficiency in accordance with RESPA, but in no more than 12 monthly payments.

Upon payment in full of all sums secured by this Security Instrument, Lender shall promptly refund to Borrower any Funds held by Lender.

4. Charges; Liens. Borrower shall pay all taxes, assessments, charges, fines, and impositions attributable to the Property which can attain priority over this Security Instrument, leasehold payments or ground rents on the Property, if any, and Community Association Dues, Fees, and Assessments, if any. To the extent that these items are Escrow Items, Borrower shall pay them in the manner provided in Section 3.

Borrower shall promptly discharge any lien which has priority over this Security Instrument unless Borrower: (a) agrees in writing to the payment of the obligation secured by the lien in a manner acceptable to Lender, but only so long as Borrower is performing such agreement; (b) contests the lien in good faith by, or defends against enforcement of the lien in, legal proceedings which in Lender's opinion operate to prevent the enforcement of the lien while those proceedings are pending, but only until such proceedings are concluded; or (c) secures from the holder of the lien an agreement satisfactory to Lender subordinating the lien to this Security Instrument. If Lender determines that any part of the Property is subject to a lien which can attain priority over this Security Instrument, Lender may give Borrower a notice identifying the lien. Within 10 days of the date on which that notice is given, Borrower shall satisfy the lien or take one or more of the actions set forth above in this Section 4.

THIS

DOC ID #: 00013884537607006

Lender may require Borrower to pay a one-time charge for a real estate tax verification and/or reporting service used by Lender in connection with this Loan.

5. **Property Insurance.** Borrower shall keep the improvements now existing or hereafter erected on the Property insured against loss by fire, hazards included within the term "extended coverage," and any other hazards including, but not limited to, earthquakes and floods, for which Lender requires insurance. This insurance shall be maintained in the amounts (including deductible levels) and for the periods that Lender requires. What Lender requires pursuant to the preceding sentences can change during the term of the Loan. The insurance carrier providing the insurance shall be chosen by Borrower subject to Lender's right to disapprove Borrower's choice, which right shall not be exercised unreasonably. Lender may require Borrower to pay, in connection with this Loan, either: (a) a one-time charge for flood zone determination, certification and tracking services; or (b) a one-time charge for flood zone determination and certification services and subsequent charges each time remappings or similar changes occur which reasonably might affect such determination or certification. Borrower shall also be responsible for the payment of any fees imposed by the Federal Emergency Management Agency in connection with the review of any flood zone determination resulting from an objection by Borrower.

If Borrower fails to maintain any of the coverages described above, Lender may obtain insurance coverage, at Lender's option and Borrower's expense. Lender is under no obligation to purchase any particular type or amount of coverage. Therefore, such coverage shall cover Lender, but might or might not protect Borrower, Borrower's equity in the Property, or the contents of the Property, against any risk, hazard or liability and might provide greater or lesser coverage than was previously in effect. Borrower acknowledges that the cost of the insurance coverage so obtained might significantly exceed the cost of insurance that Borrower could have obtained. Any amounts disbursed by Lender under this Section 5 shall become additional debt of Borrower secured by this Security Instrument. These amounts shall bear interest at the Note rate from the date of disbursement and shall be payable, with such interest, upon notice from Lender to Borrower requesting payment.

All insurance policies required by Lender and renewals of such policies shall be subject to Lender's right to disapprove such policies, shall include a standard mortgage clause, and shall name Lender as mortgagee and/or as an additional loss payee. Lender shall have the right to hold the policies and renewal certificates. If Lender requires, Borrower shall promptly give to Lender all receipts of paid premiums and renewal notices. If Borrower obtains any form of insurance coverage, not otherwise required by Lender, for damage to, or destruction of, the Property, such policy shall include a standard mortgage clause and shall name Lender as mortgagee and/or as an additional loss payee.

In the event of loss, Borrower shall give prompt notice to the insurance carrier and Lender. Lender may make proof of loss if not made promptly by Borrower. Unless Lender and Borrower otherwise agree in writing, any insurance proceeds, whether or not the underlying insurance was required by Lender, shall be applied to restoration or repair of the Property, if the restoration or repair is economically feasible and Lender's security is not lessened. During such repair and restoration period, Lender shall have the right to hold such insurance proceeds until Lender has had an opportunity to inspect such Property to ensure the work has been completed to Lender's satisfaction, provided that such inspection shall be undertaken promptly. Lender may disburse proceeds for the repairs and restoration in a single payment or in a series of progress payments as the work is completed. Unless an agreement is made in writing or Applicable Law requires interest to be paid on such insurance proceeds, Lender shall not be required to pay Borrower any interest or earnings on such proceeds. Fees for public adjusters, or other third parties, retained by Borrower shall not be paid out of the insurance proceeds and shall be the sole obligation of Borrower. If the restoration or repair is not economically feasible or Lender's security would be lessened, the insurance proceeds shall be applied to the sums secured by this Security Instrument, whether or not then due, with the excess, if any, paid to Borrower. Such insurance proceeds shall be applied in the order provided for in Section 2.

If Borrower abandons the Property, Lender may file, negotiate and settle any available insurance claim and related matters. If Borrower does not respond within 30 days to a notice from Lender that the insurance carrier has offered to settle a claim, then Lender may negotiate and settle the claim. The 30-day period will begin when the notice is given. In either event, or if Lender acquires the Property under Section 22 or otherwise, Borrower hereby assigns to Lender (a) Borrower's rights to any insurance proceeds in an amount not to exceed the amounts unpaid under the Note or this Security Instrument, and (b) any other of Borrower's rights (other than the right to any refund of unearned premiums paid by Borrower) under all insurance policies covering the Property, insofar as such rights are applicable to the coverage of the Property. Lender may use the insurance proceeds either to repair or restore the Property or to pay amounts unpaid under the Note or this Security Instrument, whether or not then due.

This document is a copy of a document filed with the court. It is not a legal document and should not be used as such.

DOC ID #: 00013884537607006

6. Occupancy. Borrower shall occupy, establish, and use the Property as Borrower's principal residence within 60 days after the execution of this Security Instrument and shall continue to occupy the Property as Borrower's principal residence for at least one year after the date of occupancy, unless Lender otherwise agrees in writing, which consent shall not be unreasonably withheld, or unless extenuating circumstances exist which are beyond Borrower's control.

7. Preservation, Maintenance and Protection of the Property; Inspections. Borrower shall not destroy, damage or impair the Property, allow the Property to deteriorate or commit waste on the Property. Whether or not Borrower is residing in the Property, Borrower shall maintain the Property in order to prevent the Property from deteriorating or decreasing in value due to its condition. Unless it is determined pursuant to Section 5 that repair or restoration is not economically feasible, Borrower shall promptly repair the Property if damaged to avoid further deterioration or damage. If insurance or condemnation proceeds are paid in connection with damage to, or the taking of, the Property, Borrower shall be responsible for repairing or restoring the Property only if Lender has released proceeds for such purposes. Lender may disburse proceeds for the repairs and restoration in a single payment or in a series of progress payments as the work is completed. If the insurance or condemnation proceeds are not sufficient to repair or restore the Property, Borrower is not relieved of Borrower's obligation for the completion of such repair or restoration.

Lender or its agent may make reasonable entries upon and inspections of the Property. If it has reasonable cause, Lender may inspect the interior of the improvements on the Property. Lender shall give Borrower notice at the time of or prior to such an interior inspection specifying such reasonable cause.

8. Borrower's Loan Application. Borrower shall be in default if, during the Loan application process, Borrower or any persons or entities acting at the direction of Borrower or with Borrower's knowledge or consent gave materially false, misleading, or inaccurate information or statements to Lender (or failed to provide Lender with material information) in connection with the Loan. Material representations include, but are not limited to, representations concerning Borrower's occupancy of the Property as Borrower's principal residence.

9. Protection of Lender's Interest in the Property and Rights Under this Security Instrument. If (a) Borrower fails to perform the covenants and agreements contained in this Security Instrument, (b) there is a legal proceeding that might significantly affect Lender's interest in the Property and/or rights under this Security Instrument (such as a proceeding in bankruptcy, probate, for condemnation or forfeiture, for enforcement of a lien which may attain priority over this Security Instrument or to enforce laws or regulations), or (c) Borrower has abandoned the Property, then Lender may do and pay for whatever is reasonable or appropriate to protect Lender's interest in the Property and rights under this Security Instrument, including protecting and/or assessing the value of the Property, and securing and/or repairing the Property. Lender's actions can include, but are not limited to: (a) paying any sums secured by a lien which has priority over this Security Instrument; (b) appearing in court; and (c) paying reasonable attorneys' fees to protect its interest in the Property and/or rights under this Security Instrument, including its secured position in a bankruptcy proceeding. Securing the Property includes, but is not limited to, entering the Property to make repairs, change locks, replace or board up doors and windows, drain water from pipes, eliminate building or other code violations or dangerous conditions, and have utilities turned on or off. Although Lender may take action under this Section 9, Lender does not have to do so and is not under any duty or obligation to do so. It is agreed that Lender incurs no liability for not taking any or all actions authorized under this Section 9.

Any amounts disbursed by Lender under this Section 9 shall become additional debt of Borrower secured by this Security Instrument. These amounts shall bear interest at the Note rate from the date of disbursement and shall be payable, with such interest, upon notice from Lender to Borrower requesting payment.

If this Security Instrument is on a leasehold, Borrower shall comply with all the provisions of the lease. If Borrower acquires fee title to the Property, the leasehold and the fee title shall not merge unless Lender agrees to the merger in writing.

10. Mortgage Insurance. If Lender required Mortgage Insurance as a condition of making the Loan, Borrower shall pay the premiums required to maintain the Mortgage Insurance in effect. If, for any reason, the Mortgage Insurance coverage required by Lender ceases to be available from the mortgage insurer that previously provided such insurance and Borrower was required to make separately designated payments toward the premiums for Mortgage Insurance, Borrower shall pay the premiums required to obtain coverage substantially equivalent to the Mortgage Insurance previously in effect, at a cost substantially equivalent to the cost to Borrower of the Mortgage Insurance previously in effect, from an alternate mortgage insurer selected by Lender. If substantially equivalent Mortgage Insurance coverage is not available, Borrower shall continue to pay to Lender the amount of the separately designated payments that were due when the insurance coverage ceased to be in effect. Lender will accept, use and retain these payments as a non-refundable loss reserve in lieu of Mortgage Insurance. Such loss reserve shall be non-refundable, notwithstanding the fact that the Loan is ultimately paid in full, and Lender shall not be required to pay Borrower any interest or earnings on such loss reserve. Lender can no longer require loss reserve payments if Mortgage Insurance coverage (in the

This

DOC ID #: 00013884537607006

amount and for the period that Lender requires) provided by an insurer selected by Lender again becomes available, is obtained, and Lender requires separately designated payments toward the premiums for Mortgage Insurance. If Lender required Mortgage Insurance as a condition of making the Loan and Borrower was required to make separately designated payments toward the premiums for Mortgage Insurance, Borrower shall pay the premiums required to maintain Mortgage Insurance in effect, or to provide a non-refundable loss reserve, until Lender's requirement for Mortgage Insurance ends in accordance with any written agreement between Borrower and Lender providing for such termination or until termination is required by Applicable Law. Nothing in this Section 10 affects Borrower's obligation to pay interest at the rate provided in the Note.

Mortgage Insurance reimburses Lender (or any entity that purchases the Note) for certain losses it may incur if Borrower does not repay the Loan as agreed. Borrower is not a party to the Mortgage Insurance.

Mortgage insurers evaluate their total risk on all such insurance in force from time to time, and may enter into agreements with other parties that share or modify their risk, or reduce losses. These agreements are on terms and conditions that are satisfactory to the mortgage insurer and the other party (or parties) to these agreements. These agreements may require the mortgage insurer to make payments using any source of funds that the mortgage insurer may have available (which may include funds obtained from Mortgage Insurance premiums).

As a result of these agreements, Lender, any purchaser of the Note, another insurer, any reinsurer, any other entity, or any affiliate of any of the foregoing, may receive (directly or indirectly) amounts that derive from (or might be characterized as) a portion of Borrower's payments for Mortgage Insurance, in exchange for sharing or modifying the mortgage insurer's risk, or reducing losses. If such agreement provides that an affiliate of Lender takes a share of the insurer's risk in exchange for a share of the premiums paid to the insurer, the arrangement is often termed "captive reinsurance." Further:

(a) Any such agreements will not affect the amounts that Borrower has agreed to pay for Mortgage Insurance, or any other terms of the Loan. Such agreements will not increase the amount Borrower will owe for Mortgage Insurance, and they will not entitle Borrower to any refund.

(b) Any such agreements will not affect the rights Borrower has - if any - with respect to the Mortgage Insurance under the Homeowners Protection Act of 1998 or any other law. These rights may include the right to receive certain disclosures, to request and obtain cancellation of the Mortgage Insurance, to have the Mortgage Insurance terminated automatically, and/or to receive a refund of any Mortgage Insurance premiums that were unearned at the time of such cancellation or termination.

11. Assignment of Miscellaneous Proceeds; Forfeiture. All Miscellaneous Proceeds are hereby assigned to and shall be paid to Lender.

If the Property is damaged, such Miscellaneous Proceeds shall be applied to restoration or repair of the Property, if the restoration or repair is economically feasible and Lender's security is not lessened. During such repair and restoration period, Lender shall have the right to hold such Miscellaneous Proceeds until Lender has had an opportunity to inspect such Property to ensure the work has been completed to Lender's satisfaction, provided that such inspection shall be undertaken promptly. Lender may pay for the repairs and restoration in a single disbursement or in a series of progress payments as the work is completed. Unless an agreement is made in writing or Applicable Law requires interest to be paid on such Miscellaneous Proceeds, Lender shall not be required to pay Borrower any interest or earnings on such Miscellaneous Proceeds. If the restoration or repair is not economically feasible or Lender's security would be lessened, the Miscellaneous Proceeds shall be applied to the sums secured by this Security Instrument, whether or not then due, with the excess, if any, paid to Borrower. Such Miscellaneous Proceeds shall be applied in the order provided for in Section 2.

In the event of a total taking, destruction, or loss in value of the Property, the Miscellaneous Proceeds shall be applied to the sums secured by this Security Instrument, whether or not then due, with the excess, if any, paid to Borrower.

In the event of a partial taking, destruction, or loss in value of the Property in which the fair market value of the Property immediately before the partial taking, destruction, or loss in value is equal to or greater than the amount of the sums secured by this Security Instrument immediately before the partial taking, destruction, or loss in value, unless Borrower and Lender otherwise agree in writing, the sums secured by this Security Instrument shall be reduced by the amount of the Miscellaneous Proceeds multiplied by the following fraction: (a) the total amount of the sums secured immediately before the partial taking, destruction, or loss in value divided by (b) the fair market value of the Property immediately before the partial taking, destruction, or loss in value. Any balance shall be paid to Borrower.

In the event of a partial taking, destruction, or loss in value of the Property in which the fair market value of the Property immediately before the partial taking, destruction, or loss in value is less than the amount of the sums secured immediately before the partial taking, destruction, or loss in value, unless Borrower and Lender otherwise agree in writing, the Miscellaneous Proceeds shall be applied to the sums secured by this Security Instrument whether or not the sums are then due.

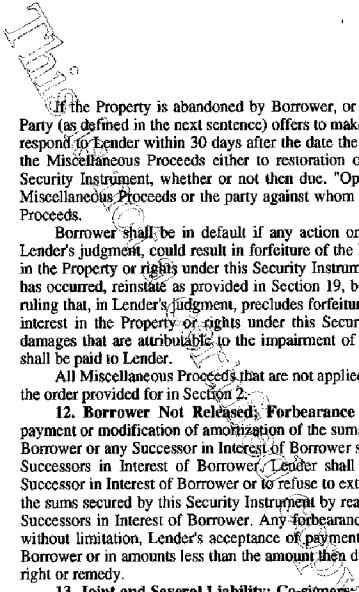

DOC ID #: 00013884537607006

If the Property is abandoned by Borrower, or if, after notice by Lender to Borrower that the Opposing Party (as defined in the next sentence) offers to make an award to settle a claim for damages, Borrower fails to respond to Lender within 30 days after the date the notice is given, Lender is authorized to collect and apply the Miscellaneous Proceeds either to restoration or repair of the Property or to the sums secured by this Security Instrument, whether or not then due. "Opposing Party" means the third party that owes Borrower Miscellaneous Proceeds or the party against whom Borrower has a right of action in regard to Miscellaneous Proceeds.

Borrower shall be in default if any action or proceeding, whether civil or criminal, is begun that, in Lender's judgment, could result in forfeiture of the Property or other material impairment of Lender's interest in the Property or rights under this Security Instrument. Borrower can cure such a default and, if acceleration has occurred, reinstated as provided in Section 19, by causing the action or proceeding to be dismissed with a ruling that, in Lender's judgment, precludes forfeiture of the Property or other material impairment of Lender's interest in the Property or rights under this Security Instrument. The proceeds of any award or claim for damages that are attributable to the impairment of Lender's interest in the Property are hereby assigned and shall be paid to Lender.

All Miscellaneous Proceeds that are not applied to restoration or repair of the Property shall be applied in the order provided for in Section 2.

12. Borrower Not Released; Forbearance By Lender Not a Waiver. Extension of the time for payment or modification of amortization of the sums secured by this Security Instrument granted by Lender to Borrower or any Successor in Interest of Borrower shall not operate to release the liability of Borrower or any Successors in Interest of Borrower. Lender shall not be required to commence proceedings against any Successor in Interest of Borrower or to refuse to extend time for payment or otherwise modify amortization of the sums secured by this Security Instrument by reason of any demand made by the original Borrower or any Successors in Interest of Borrower. Any forbearance by Lender in exercising any right or remedy including, without limitation, Lender's acceptance of payments from third persons, entities or Successors in Interest of Borrower or in amounts less than the amount then due, shall not be a waiver of or preclude the exercise of any right or remedy.

13. Joint and Several Liability; Co-signers; Successors and Assigns Bound. Borrower covenants and agrees that Borrower's obligations and liability shall be joint and several. However, any Borrower who co-signs this Security Instrument but does not execute the Note (a "co-signer"): (a) is co-signing this Security Instrument only to mortgage, grant and convey the co-signer's interest in the Property under the terms of this Security Instrument; (b) is not personally obligated to pay the sums secured by this Security Instrument; and (c) agrees that Lender and any other Borrower can agree to extend, modify, forbear or make any accommodations with regard to the terms of this Security Instrument or the Note without the co-signer's consent.

Subject to the provisions of Section 18, any Successor in Interest of Borrower who assumes Borrower's obligations under this Security Instrument in writing, and is approved by Lender, shall obtain all of Borrower's rights and benefits under this Security Instrument. Borrower shall not be released from Borrower's obligations and liability under this Security Instrument unless Lender agrees to such release in writing. The covenants and agreements of this Security Instrument shall bind (except as provided in Section 20) and benefit the successors and assigns of Lender.

14. Loan Charges. Lender may charge Borrower fees for services performed in connection with Borrower's default, for the purpose of protecting Lender's interest in the Property and rights under this Security Instrument, including, but not limited to, attorneys' fees, property inspection and valuation fees. In regard to any other fees, the absence of express authority in this Security Instrument to charge a specific fee to Borrower shall not be construed as a prohibition on the charging of such fee. Lender may not charge fees that are expressly prohibited by this Security Instrument or by Applicable Law.

If the Loan is subject to a law which sets maximum loan charges, and that law is finally interpreted so that the interest or other loan charges collected or to be collected in connection with the Loan exceed the permitted limits, then: (a) any such loan charge shall be reduced by the amount necessary to reduce the charge to the permitted limit; and (b) any sums already collected from Borrower which exceeded permitted limits will be refunded to Borrower. Lender may choose to make this refund by reducing the principal owed under the Note or by making a direct payment to Borrower. If a refund reduces principal, the reduction will be treated as a partial prepayment without any prepayment charge (whether or not a prepayment charge is provided for under the Note). Borrower's acceptance of any such refund made by direct payment to Borrower will constitute a waiver of any right of action Borrower might have arising out of such overcharge.

15. Notices. All notices given by Borrower or Lender in connection with this Security Instrument must be in writing. Any notice to Borrower in connection with this Security Instrument shall be deemed to have been given to Borrower when mailed by first class mail or when actually delivered to Borrower's notice address if sent by other means. Notice to any one Borrower shall constitute notice to all Borrowers unless Applicable Law expressly requires otherwise. The notice address shall be the Property Address unless

DOC ID #: 00013884537607006

Borrower has designated a substitute notice address by notice to Lender. Borrower shall promptly notify Lender of Borrower's change of address. If Lender specifies a procedure for reporting Borrower's change of address, then Borrower shall only report a change of address through that specified procedure. There may be only one designated notice address under this Security Instrument at any one time. Any notice to Lender shall be given by delivering it or by mailing it by first class mail to Lender's address stated herein unless Lender has designated another address by notice to Borrower. Any notice in connection with this Security Instrument shall not be deemed to have been given to Lender until actually received by Lender. If any notice required by this Security Instrument is also required under Applicable Law, the Applicable Law requirement will satisfy the corresponding requirement under this Security Instrument.

16. Governing Law; Severability; Rules of Construction. This Security Instrument shall be governed by federal law and the law of the jurisdiction in which the Property is located. All rights and obligations contained in this Security Instrument are subject to any requirements and limitations of Applicable Law. Applicable Law might explicitly or implicitly allow the parties to agree by contract or it might be silent, but such silence shall not be construed as a prohibition against agreement by contract. In the event that any provision or clause of this Security Instrument or the Note conflicts with Applicable Law, such conflict shall not affect other provisions of this Security Instrument or the Note which can be given effect without the conflicting provision.

As used in this Security Instrument: (a) words of the masculine gender shall mean and include corresponding neuter words or words of the feminine gender; (b) words in the singular shall mean and include the plural and vice versa; and (c) the word "may" gives sole discretion without any obligation to take any action.

17. Borrower's Copy. Borrower shall be given one copy of the Note and of this Security Instrument.

18. Transfer of the Property or a Beneficial Interest in Borrower. As used in this Section 18, "Interest in the Property" means any legal or beneficial interest in the Property, including, but not limited to, those beneficial interests transferred in a bond for deed, contract for deed, installment sales contract or escrow agreement, the intent of which is the transfer of title by Borrower at a future date to a purchaser.

If all or any part of the Property or any Interest in the Property is sold or transferred (or if Borrower is not a natural person and a beneficial interest in Borrower is sold or transferred) without Lender's prior written consent, Lender may require immediate payment in full of all sums secured by this Security Instrument. However, this option shall not be exercised by Lender if such exercise is prohibited by Applicable Law.

If Lender exercises this option, Lender shall give Borrower notice of acceleration. The notice shall provide a period of not less than 30 days from the date the notice is given in accordance with Section 15 within which Borrower must pay all sums secured by this Security Instrument. If Borrower fails to pay these sums prior to the expiration of this period, Lender may invoke any remedies permitted by this Security Instrument without further notice or demand on Borrower.

19. Borrower's Right to Reinstate After Acceleration. If Borrower meets certain conditions, Borrower shall have the right to have enforcement of this Security Instrument discontinued at any time prior to the earliest of: (a) five days before sale of the Property pursuant to any power of sale contained in this Security Instrument; (b) such other period as Applicable Law might specify for the termination of Borrower's right to reinstate; or (c) entry of a judgment enforcing this Security Instrument. Those conditions are that Borrower: (a) pays Lender all sums which then would be due under this Security Instrument and the Note as if no acceleration had occurred; (b) cures any default of any other covenants or agreements; (c) pays all expenses incurred in enforcing this Security Instrument, including, but not limited to, reasonable attorneys' fees, property inspection and valuation fees, and other fees incurred for the purpose of protecting Lender's interest in the Property and rights under this Security Instrument; and (d) takes such action as Lender may reasonably require to assure that Lender's interest in the Property and rights under this Security Instrument, and Borrower's obligation to pay the sums secured by this Security Instrument, shall continue unchanged. Lender may require that Borrower pay such reinstatement sums and expenses in one or more of the following forms, as selected by Lender: (a) cash; (b) money order; (c) certified check, bank check, treasurer's check or cashier's check, provided any such check is drawn upon an institution whose deposits are insured by a federal agency, instrumentality or entity; or (d) Electronic Funds Transfer. Upon reinstatement by Borrower, this Security Instrument and obligations secured hereby shall remain fully effective as if no acceleration had occurred. However, this right to reinstate shall not apply in the case of acceleration under Section 18.

20. Sale of Note; Change of Loan Servicer; Notice of Grievance. The Note or a partial interest in the Note (together with this Security Instrument) can be sold one or more times without prior notice to Borrower. A sale might result in a change in the entity (known as the "Loan Servicer") that collects Periodic Payments due under the Note and this Security Instrument and performs other mortgage loan servicing obligations under the Note, this Security Instrument, and Applicable Law. There also might be one or more changes of the Loan Servicer unrelated to a sale of the Note. If there is a change of the Loan Servicer, Borrower will be given written notice of the change which will state the name and address of the new Loan Servicer, the address to

This

DOC ID #: 00013884537607006

which payments should be made and any other information RESPA requires in connection with a notice of transfer of servicing. If the Note is sold and thereafter the Loan is serviced by a Loan Servicer other than the purchaser of the Note, the mortgage loan servicing obligations to Borrower will remain with the Loan Servicer or be transferred to a successor Loan Servicer and are not assumed by the Note purchaser unless otherwise provided by the Note purchaser.

Neither Borrower nor Lender may commence, join, or be joined to any judicial action (as either an individual litigant or the member of a class) that arises from the other party's actions pursuant to this Security Instrument or that alleges that the other party has breached any provision of, or any duty owed by reason of, this Security Instrument, until such Borrower or Lender has notified the other party (with such notice given in compliance with the requirements of Section 15) of such alleged breach and afforded the other party hereto a reasonable period after the giving of such notice to take corrective action. If Applicable Law provides a time period which must elapse before certain action can be taken, that time period will be deemed to be reasonable for purposes of this paragraph. The notice of acceleration and opportunity to cure given to Borrower pursuant to Section 22 and the notice of acceleration given to Borrower pursuant to Section 18 shall be deemed to satisfy the notice and opportunity to take corrective action provisions of this Section 20.

21. Hazardous Substances. As used in this Section 21: (a) "Hazardous Substances" are those substances defined as toxic or hazardous substances, pollutants, or wastes by Environmental Law and the following substances: gasoline, kerosene, other flammable or toxic petroleum products, toxic pesticides and herbicides, volatile solvents, materials containing asbestos or formaldehyde, and radioactive materials; (b) "Environmental Law" means federal laws and laws of the jurisdiction where the Property is located that relate to health, safety or environmental protection; (c) "Environmental Cleanup" includes any response action, remedial action, or removal action, as defined in Environmental Law; and (d) an "Environmental Condition" means a condition that can cause, contribute to, or otherwise trigger an Environmental Cleanup.

Borrower shall not cause or permit the presence, use, disposal, storage, or release of any Hazardous Substances, or threaten to release any Hazardous Substances, on or in the Property. Borrower shall not do, nor allow anyone else to do, anything affecting the Property (a) that is in violation of any Environmental Law, (b) which creates an Environmental Condition, or (c) which, due to the presence, use, or release of a Hazardous Substance, creates a condition that adversely affects the value of the Property. The preceding two sentences shall not apply to the presence, use, or storage on the Property of small quantities of Hazardous Substances that are generally recognized to be appropriate to normal residential uses and to maintenance of the Property (including, but not limited to, hazardous substances in consumer products).

Borrower shall promptly give Lender written notice of (a) any investigation, claim, demand, lawsuit or other action by any governmental or regulatory agency or private party involving the Property and any Hazardous Substance or Environmental Law of which Borrower has actual knowledge, (b) any Environmental Condition, including but not limited to, any spilling, leaking, discharge, release or threat of release of any Hazardous Substance, and (c) any condition caused by the presence, use or release of a Hazardous Substance which adversely affects the value of the Property. If Borrower learns, or is notified by any governmental or regulatory authority, or any private party, that any removal or other remediation of any Hazardous Substance affecting the Property is necessary, Borrower shall promptly take all necessary remedial actions in accordance with Environmental Law. Nothing herein shall create any obligation on Lender for an Environmental Cleanup.

NON-UNIFORM COVENANTS. Borrower and Lender further covenant and agree as follows:

22. Acceleration; Remedies. Lender shall give notice to Borrower prior to acceleration following Borrower's breach of any covenant or agreement in this Security Instrument (but not prior to acceleration under Section 18 unless Applicable Law provides otherwise). The notice shall specify: (a) the default; (b) the action required to cure the default; (c) a date, not less than 30 days from the date the notice is given to Borrower, by which the default must be cured; and (d) that failure to cure the default on or before the date specified in the notice may result in acceleration of the sums secured by this Security Instrument, foreclosure by judicial proceeding and sale of the Property. The notice shall further inform Borrower of the right to reinstate after acceleration and the right to assert in the foreclosure proceeding the non-existence of a default or any other defense of Borrower to acceleration and foreclosure. If the default is not cured on or before the date specified in the notice, Lender at its option may require immediate payment in full of all sums secured by this Security Instrument without further demand and may foreclose this Security Instrument by judicial proceeding. Lender shall be entitled to collect all expenses incurred in pursuing the remedies provided in this Section 22, including, but not limited to, reasonable attorneys' fees and costs of title evidence.

23. Release. Upon payment of all sums secured by this Security Instrument, Lender shall release this Security Instrument. Borrower shall pay any recordation costs. Lender may charge Borrower a fee for releasing this Security Instrument, but only if the fee is paid to a third party for services rendered and the charging of the fee is permitted under Applicable Law.

DOC ID #: 00013884537607006

24. Attorneys' Fees. As used in this Security Instrument and the Note, attorneys' fees shall include those awarded by an appellate court and any attorneys' fees incurred in a bankruptcy proceeding.

25. Jury Trial Waiver. The Borrower hereby waives any right to a trial by jury in any action, proceeding, claim, or counterclaim, whether in contract or tort, at law or in equity, arising out of or in any way related to this Security Instrument or the Note.

BY SIGNING BELOW, Borrower accepts and agrees to the terms and covenants contained in this Security Instrument and in any Rider executed by Borrower and recorded with it.

Signed, sealed and delivered in the presence of:

[Signature] _____ (Seal)
 JEAN B. JEANGLAUBE -Borrower
 11 HEMMING DR (Address)
 STAFFORD, VA 22554

[Signature] _____ (Seal)
 GERTRUDE ARTHUR-JEANGLAUBE -Borrower
 11 HEMMING DR (Address)
 STAFFORD, VA 22554

_____ (Seal)
 -Borrower
 _____ (Address)

_____ (Seal)
 -Borrower
 _____ (Address)

STATE OF VA, ~~FLORIDA~~ Stafford County ss: Stafford
 The foregoing instrument was acknowledged before me this August 3rd 2006 by
 JEAN B JEANGLAUBE AND GERTRUDE ARTHUR JEANGLAUBE

 who is personally known to me or who has produced driver's licenses as identification.

[Signature]
 Notary Public 3/3/07

Prepared by: YVETTE ZAPATA

GL FINANCIAL SERVICES, LLC.

DATE: 08/03/2006

CASE #:

DOC ID #: 00013884537607006

BORROWER: JEAN B. JEANLAUDE

PROPERTY ADDRESS: 8671 THORNBROOK TERRACE POINT
Boynton Beach, FL 33437-4882

210 N. UNIVERSITY DR STE 601
CORAL SPRINGS, FL 33071
Phone: (954) 825-4300
Brk Fax No.: (954) 825-4320

LEGAL DESCRIPTION EXHIBIT A

Lot 117, CANYON ISLES PLAT ONE, according to the plat thereof, as recorded in Plat Book 105 at Page 1 of the Public Records of Palm Beach County, Florida

FHAVA/CONV
Legal Description Exhibit A
2C404-XX (04/03)d



This is not a certified copy

PLANNED UNIT DEVELOPMENT RIDER

After Recording Return To:
COUNTRYWIDE HOME LOANS, INC.
MS SV-79 DOCUMENT PROCESSING
P.O.Box 10423
Van Nuys, CA 91410-0423

Prepared By:
YVETTE ZAPATA
GL FINANCIAL SERVICES, LLC.

210 N. UNIVERSITY DR STE 601
CORAL SPRINGS, FL 33071

00013884537607006
[Doc ID #]

THIS PLANNED UNIT DEVELOPMENT RIDER is made this **THIRD** day of **AUGUST, 2006**, and is incorporated into and shall be deemed to amend and supplement the Mortgage, Deed of Trust, or Security Deed (the "Security Instrument") of the same date, given by the undersigned (the "Borrower") to secure Borrower's Note to **GL FINANCIAL SERVICES, LLC.**

(the "Lender") of the same date and covering the Property described in the Security Instrument and located at:

8671 THORNBROOK TERRACE POINT
Boynton Beach, FL 33437-4882
[Property Address]

The Property includes, but is not limited to, a parcel of land improved with a dwelling, together with

MULTISTATE PUD RIDER - Single Family - Fannie Mae/Freddie Mac UNIFORM INSTRUMENT
VMP-7R (0405) CHL (06/04)(d) Page 1 of 3 Initials **GAJ**
VMP Mortgage Solutions, Inc. (800)521-7291 Form 3150 1/01



This document is not a contract

DOC ID #: 00013884537607006

other such parcels and certain common areas and facilities, as described in THE COVENANTS, CONDITIONS, AND RESTRICTIONS FILED OF RECORD THAT AFFECT THE PROPERTY

ORB 19820, PG 216

(the "Declaration"). The Property is a part of a planned unit development known as CANYON ISLES

[Name of Planned Unit Development]

(the "PUD"). The Property also includes Borrower's interest in the homeowners association or equivalent entity owning or managing the common areas and facilities of the PUD (the "Owners Association") and the uses, benefits and proceeds of Borrower's interest.

PUD COVENANTS. In addition to the covenants and agreements made in the Security Instrument, Borrower and Lender further covenant and agree as follows:

A. PUD Obligations. Borrower shall perform all of Borrower's obligations under the PUD's Constituent Documents. The "Constituent Documents" are the (i) Declaration; (ii) articles of incorporation, trust instrument or any equivalent document which creates the Owners Association; and (iii) any by-laws or other rules or regulations of the Owners Association. Borrower shall promptly pay, when due, all dues and assessments imposed pursuant to the Constituent Documents.

B. Property Insurance. So long as the Owners Association maintains, with a generally accepted insurance carrier, a "master" or "blanket" policy insuring the Property which is satisfactory to Lender and which provides insurance coverage in the amounts (including deductible levels), for the periods, and against loss by fire, hazards included within the term "extended coverage," and any other hazards, including, but not limited to, earthquakes and floods, for which Lender requires insurance, then: (i) Lender waives the provision in Section 3 for the Periodic Payment to Lender of the yearly premium installments for property insurance on the Property; and (ii) Borrower's obligation under Section 5 to maintain property insurance coverage on the Property is deemed satisfied to the extent that the required coverage is provided by the Owners Association policy.

What Lender requires as a condition of this waiver can change during the term of the loan.

Borrower shall give Lender prompt notice of any lapse in required property insurance coverage provided by the master or blanket policy.

In the event of a distribution of property insurance proceeds in lieu of restoration or repair following a loss to the Property, or to common areas and facilities of the PUD, any proceeds payable to Borrower are hereby assigned and shall be paid to Lender. Lender shall apply the proceeds to the sums secured by the Security Instrument, whether or not then due, with the excess, if any, paid to Borrower.

C. Public Liability Insurance. Borrower shall take such actions as may be reasonable to insure that the Owners Association maintains a public liability insurance policy acceptable in form, amount, and extent of coverage to Lender.

D. Condemnation. The proceeds of any award or claim for damages, direct or consequential, payable to Borrower in connection with any condemnation or other taking of all or any part of the Property or the common areas and facilities of the PUD, or for any conveyance in lieu of condemnation, are hereby assigned and shall be paid to Lender. Such proceeds shall be applied by Lender to the sums secured by the Security Instrument as provided in Section 11.

E. Lender's Prior Consent. Borrower shall not, except after notice to Lender and with Lender's prior written consent, either partition or subdivide the Property or consent to: (i) the abandonment or termination of the PUD, except for abandonment or termination required by law in the case of substantial destruction by fire or other casualty or in the case of a taking by condemnation or eminent domain; (ii) any amendment to any provision of the "Constituent Documents" if the provision is for the

Initials: [Handwritten initials] Form 3150 1/01

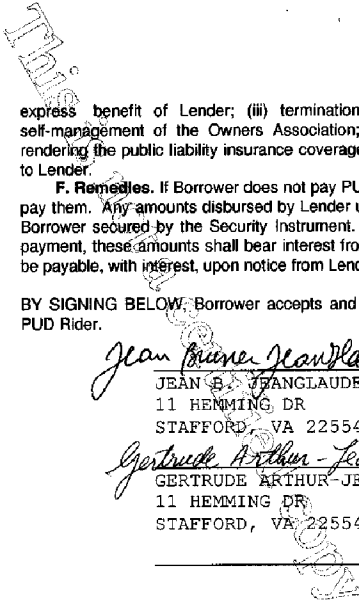

DOC ID #: 00013884537607006

express benefit of Lender; (iii) termination of professional management and assumption of self-management of the Owners Association; or (iv) any action which would have the effect of rendering the public liability insurance coverage maintained by the Owners Association unacceptable to Lender.

F. Remedies. If Borrower does not pay PUD dues and assessments when due, then Lender may pay them. Any amounts disbursed by Lender under this paragraph F shall become additional debt of Borrower secured by the Security Instrument. Unless Borrower and Lender agree to other terms of payment, these amounts shall bear interest from the date of disbursement at the Note rate and shall be payable, with interest, upon notice from Lender to Borrower requesting payment.

BY SIGNING BELOW, Borrower accepts and agrees to the terms and provisions contained in this PUD Rider.

Jean Marie Jeanglaude (Seal)
JEAN B. JEANGLAUE - Borrower
11 HEMMING DR
STAFFORD, VA 22554

Gertrude Arthur - Jeanglaude (Seal)
GERTRUDE ARTHUR - JEANGLAUE - Borrower
11 HEMMING DR
STAFFORD, VA 22554

____ (Seal)
- Borrower

____ (Seal)
- Borrower

This is not a certified copy

SECOND HOME RIDER

After Recording Return To:
COUNTRYWIDE HOME LOANS, INC.
MS SV-79 DOCUMENT PROCESSING
P.O.Box 10423
Van Nuys, CA 91410-0423

Prepared By:
YVETTE ZAPATA
GL FINANCIAL SERVICES, LLC.

210 N. UNIVERSITY DR STE 601
CORAL SPRINGS, FL 33071

00013884537607006
[Doc ID #]

THIS SECOND HOME RIDER is made this THIRD day of
AUGUST, 2006, and is incorporated into and shall be deemed to amend and supplement
the Mortgage, Deed of Trust, or Security Deed (the "Security Instrument") of the same date given by the
undersigned (the "Borrower" whether there are one or more persons undersigned) to secure Borrower's Note to
GL FINANCIAL SERVICES, LLC.

(the "Lender") of the same date and covering the Property described in the Security Instrument (the "Property"),
which is located at:

8671 THORNBROOK TERRACE POINT
Boynton Beach, FL 33437-4882
[Property Address]

MULTISTATE SECOND HOME RIDER - Single Family - Fannie Mae/Freddie Mac UNIFORM
INSTRUMENT Page 1 of 2 Initials: [Signature]
VMP-365R (0405) CHL (06/04)(d) Form 3890 1/01
VMP Mortgage Solutions, Inc. (800)521-7291



This document contains information that is confidential and exempt from disclosure under the Freedom of Information Act.

DOC ID #: 00013884537607006

In addition to the covenants and agreements made in the Security Instrument, Borrower and Lender further covenant and agree that Sections 6 and 8 of the Security Instrument are deleted and are replaced by the following:

- 6. **Occupancy.** Borrower shall occupy, and shall only use, the Property as Borrower's second home. Borrower shall keep the Property available for Borrower's exclusive use and enjoyment at all times, and shall not subject the Property to any timesharing or other shared ownership arrangement or to any rental pool or agreement that requires Borrower either to rent the Property or give a management firm or any other person any control over the occupancy or use of the Property.
- 8. **Borrower's Loan Application.** Borrower shall be in default if, during the Loan application process, Borrower or any persons or entities acting at the direction of Borrower or with Borrower's knowledge or consent gave materially false, misleading, or inaccurate information or statements to Lender (or failed to provide Lender with material information) in connection with the Loan. Material representations include, but are not limited to, representations concerning Borrower's occupancy of the Property as Borrower's second home.

BY SIGNING BELOW, Borrower accepts and agrees to the terms and provisions contained in this Second Home Rider.

Jean Bruce Jean Claude _____ (Seal)
- Borrower

JEAN B. JEANGLAUE
11 HEMMING DR
STAFFORD, VA 22554

Gertrude Arthur Jeanglaude _____ (Seal)
- Borrower

GERTRUDE ARTHUR-JEANGLAUE
11 HEMMING DR
STAFFORD, VA 22554

- Borrower

- Borrower



3

After Recording Return To:
 COUNTRYWIDE HOME LOANS, INC. ^{RETRON KK}
 MS SV-79 DOCUMENT PROCESSING ^{NOVA}
 P.O. Box 10423
 Van Nuys, CA 91410-0423
 1401 UNIVERSITY DR. SUITE 402
 CORAL SPRINGS, FL 33071-8888
 This document was prepared by:
 YVETTE ZAPATA
 GL FINANCIAL SERVICES, LLC.
 (954) 755-9899

CFN 20060462329
 OR BK 20706 PG 0344
 RECORDED 08/08/2006 15:46:06
 Palm Beach County, Florida
 AMT 141,120.00
 Deed Doc 494.20
 Intang 282.24
 Sharon R. Bock, CLERK & COMPTROLLER
 Pgs 0344 - 354; (11pgs)

W/C 84

210 N. UNIVERSITY DR STE 601
 CORAL SPRINGS, FL 33071

[Space Above This Line For Recording Data]

00013884536807006
 [Doc ID #]

MORTGAGE
 (Line of Credit)

MIN 1000157-0007101590-9

THIS MORTGAGE, dated AUGUST 03, 2006, is between
 JEAN B JEANGLAUDE, AND GERTRUDE ARTHUR-JEANGLAUDE, HUSBAND AND WIFE

residing at
 11 HEMMING DR

the person or persons signing as "Mortgagor(s)" below and hereinafter referred to as "we," "our," or "us" and MORTGAGE ELECTRONIC REGISTRATION SYSTEMS, INC., ("MERS") a Delaware corporation with an address of P.O. Box 2026, Flint, MI 48503-2026, tel. (888) 679-MERS acting solely as nominee for GL FINANCIAL SERVICES, LLC. ("Lender" or "you") and its successors and assigns. MERS is the "Mortgagee" under this Mortgage.

MORTGAGED PREMISES: In consideration of the loan hereinafter described, we hereby mortgage, grant and convey to MERS (solely as nominee for Lender and Lender's successors and assigns) and to the successors and assigns of MERS, the premises located at:

8671 THORNBROOK TERRACE POINT

Street

BOYNTON BEACH

PALM BEACH

Municipality

County

FL 33437 (the "Premises").

State ZIP

and further described as:

SEE EXHIBIT "A" ATTACHED HERETO AND MADE A PART HEREOF.

● MERS HELOC - FL MORTGAGE
 2D993-FL (11/04)(c)

Page 1 of 5

INITIALS
 MERE
 Initials: ABJ
GAJ



DOC ID #: 00013884536807006

The Premises includes all buildings and other improvements now or in the future on the Premises and all rights and interests which derive from our ownership, use or possession of the Premises and all appurtenances thereto.

WE UNDERSTAND and agree that MERS is a separate corporation acting solely as nominee for Lender and Lender's successors and assigns, and holds only legal title to the interests granted by us in this Mortgage, but, if necessary to comply with law or custom, MERS (as nominee for Lender and Lender's successors and assigns) has the right: to exercise any or all of those interests, including, but not limited to, the right to foreclose and sell the Property, and to take any action required of Lender including, but not limited to, releasing or canceling this Mortgage

LOAN: This Mortgage will secure Lender's loan to us in the principal amount of \$ 141,120.00 or so much thereof as may be advanced and readvanced from time to time to JEAN B. JEANGLAIDE GERTRUDE ARTHUR-JEANGLAIDE , and

the Borrower(s) under the Home Equity Credit Line Agreement And Disclosure Statement (the "Note") dated 08/03/2006 , plus interest and costs, late charges and all other charges related to the loan, all of which sums are repayable according to the Note. This Mortgage will also secure the performance of all of the promises and agreements made by us and each Borrower and Co-Signer in the Note, all of our promises and agreements in this Mortgage, any extensions, renewals, amendments, supplements and other modifications of the Note, and any amounts advanced by you under the terms of the section of this Mortgage entitled "Our Authority To You." Loans under the Note may be made, repaid and remade from time to time in accordance with the terms of the Note and subject to the Credit Limit set forth in the Note.

OWNERSHIP: We are the sole owner(s) of the Premises. We have the legal right to mortgage the Premises to you.

OUR IMPORTANT OBLIGATIONS:

(a) TAXES: We will pay all real estate taxes, assessments, water charges and sewer rents relating to the Premises when they become due. We will not claim any credit on, or make deduction from, the loan under the Note because we pay these taxes and charges. We will provide Lender with proof of payment upon request.

(b) MAINTENANCE: We will maintain the building(s) on the Premises in good condition. We will not make major changes in the building(s) except for normal repairs. We will not tear down any of the building(s) on the Premises without first getting Lender's consent. We will not use the Premises illegally. If this Mortgage is on a unit in a condominium or a planned unit development, we shall perform all of our obligations under the declaration or covenants creating or governing the condominium or planned unit development, the by-laws and regulations of the condominium or planned unit development and constituent documents.

(c) INSURANCE: We will keep the building(s) on the Premises insured at all time against loss, by fire, flood and any other hazards Lender may specify. We may choose the insurance company, but our choice is subject to Lender's reasonable approval. The policies must be for at least the amounts and the time periods that Lender specifies. We will deliver to Lender upon Lender's request the policies of other proof of the insurance. The policies must name Lender as "mortgagee" and "loss-payee" so that Lender will receive payment on all insurance claims, to the extent of this Mortgage, before we do. The insurance policies must also provide that Lender be given not less than 10 days prior written notice of any cancellation or reduction in coverage, for any reason. Upon request, we shall deliver the policies, certificates or other evidence of insurance to Lender. In the event of loss or damage to the Premises, we will immediately notify Lender in writing and file a proof of loss with the insurer. Lender may file a proof of loss on our behalf if we fail or refuse to do so. Lender may also sign our name to any check, draft or other order for the payment of insurance proceeds in the event of loss or damage to the Premises. If Lender receives payment of a claim, Lender will have the right to choose to use the money either to repair the Premises or to reduce the amount owing on the Note.

(d) CONDEMNATION: We assign to Lender the proceeds of any award or claim for damages, direct or consequential, in connection with any condemnation or other taking of the Premises, or part thereof, or for conveyance in lieu of condemnation, all of which shall be paid to Lender, subject to the terms of any Prior Mortgage.

DOC ID #: 00013884536807006

(e) SECURITY INTEREST: We will join with you in signing and filing documents and, at our expense, in doing whatever you believe is necessary to perfect and continue the perfection of your lien and security interest in the Premises. It is agreed that the Lender shall be subrogated to the claims and liens of all parties whose claims or liens are discharged or paid with the proceeds of the Agreement secured hereby.

OUR AUTHORITY TO YOU: If we fail to perform our obligations under this Mortgage, Lender may, if Lender chooses, perform our obligations and pay such costs and expenses. Lender will add the amounts Lender advances to the sums owing on the Note, on which Lender will charge interest at the interest rate set forth in the Note. If, for example, we fail to honor our promises to maintain insurance in effect, or to pay filing fees, taxes or the costs necessary to keep the Premises in good condition and repair or to perform any of our agreements with Lender, Lender may, if Lender chooses, advance any sums to satisfy any of our agreements with Lender or MERS and charge us interest on such advances at the interest rate set forth in the Note. This Mortgage secures all such advances. Lender's payments on our behalf will not cure our failure to perform our promises in this Mortgage. Any replacement insurance that Lender obtains to cover loss or damages to the Premises may be limited to the amount owing on the Note plus the amount of any Prior Mortgages.

(g) PRIOR MORTGAGE: If the provisions of this paragraph are completed, this Mortgage is subject and subordinate to a prior mortgage dated 08/03/2006 and given by us to

AWL as mortgage, in the original amount of \$ 650,000.00 (the "Prior Mortgage"). We shall not increase, amend or modify the Prior Mortgage without your prior written consent and shall upon receipt of any written notice from the holder of the Prior Mortgage promptly deliver a copy of such notice to you. We shall pay and perform all of our obligations under the Prior Mortgage as and when required under the Prior Mortgage.

(h) HAZARDOUS SUBSTANCES: We shall not cause or permit the presence, use, disposal, storage, or release of any Hazardous Substances on or in the Premises. We shall not do, nor allow anyone else to do, anything affecting the Premises that is in violation of any Environmental Law. The preceding two sentences shall not apply to the presence, use, or storage on the Premises of small quantities of Hazardous Substances that are generally recognized to be appropriate to normal residential uses and to maintenance of the Premises. As used in this paragraph, "Hazardous Substances" are those substances defined as toxic or hazardous substances by Environmental Law and the following substances: gasoline, kerosene, other flammable or toxic petroleum products, toxic pesticides and herbicides, volatile solvents, materials containing asbestos or formaldehyde, and radioactive materials. As used in this paragraph, "Environmental Law" means federal laws and laws of the jurisdiction where the Premises are located that relate to health, safety or environmental protection.

(i) SALE OF PREMISES: We will not sell, transfer ownership of, mortgage or otherwise dispose of our interest in the Premises, in whole or in part, or permit any other lien or claim against the Premises without Lender's prior written consent.

(j) INSPECTION: We will permit Lender to inspect the Premises at any reasonable time.

NO LOSS OF RIGHTS: The Note and this Mortgage may be negotiated or assigned without releasing us or the Premises. Lender may add or release any person or property obligated under the Note and this Mortgage with losing rights in the Premises.

DEFAULT: Except as may be prohibited by applicable law, and subject to any advance notice and cure period if required by applicable law, if any event or condition of default as described in the Note occurs, Lender may foreclose upon this Mortgage. This means that Lender may arrange for the Premises to be sold, as provided by law, in order to pay off what we owe on the Note and under this Mortgage. If the money Lender receive from the sale is not enough to pay off what we owe, we will still owe the difference which Lender may seek to collect from us in accordance with applicable law. In addition, Lender may, in accordance with applicable law, (i) enter on and take possession of the Premises; (ii) collect the rental payments, including over-due rental payments, directly from tenants; (iii) manage the Premises; and (iv) sign, cancel and change leases. We agree that the interest rate set forth in the Note will continue before and after a default, entry of a judgment and foreclosure. In addition, Lender shall be entitled to collect all reasonable fees and costs actually incurred by Lender in proceeding to foreclosure, including, but not limited to, reasonable attorneys fees and costs of documentary evidence, abstracts and title reports.

ASSIGNMENT OF RENTS; APPOINTMENT OF RECEIVER: As additional security, we assign to you the rents of the Premises. You or a receiver appointed by the courts shall be entitled to enter upon, take possession of and manage the Premises and collect the rents of the Premises including those past due.

INITIALS: 

DOC ID #: 00013884536807006

WAIVERS: To the extent permitted by applicable law, we waive and release any error or defects in proceedings to enforce this Mortgage and hereby waive the benefit of any present or future laws providing for stay of execution, extension of time, exemption from attachment, levy and sale and homestead exemption.

BINDING EFFECT: Each of us shall be fully responsible for all of the promises and agreements in this Mortgage. Until the Note has been paid in full and the obligation to make further advances under the Note has been terminated, the provisions of this Mortgage will be binding on us, our legal representatives, our heirs and all future owners of the Premises. This Mortgage is for MERS and Lender's benefit and for the benefit of anyone to whom it may be assigned. Upon payment in full of all amounts owing under the Note and this Mortgage, and provided any obligation to make further advances under the Note has terminated, this Mortgage and your rights in the Premises shall end.

NOTICE: Except for any notice required under applicable law to be given in another manner, (a) any notice to us provided for in this Deed of Trust shall be given by delivering it or by mailing such notice by regular first class mail addressed to us at the last address appearing in your records or at such other address as we may designate by notice to you as provided herein, and (b) any notice to you shall be given by certified mail, return receipt requested, to your address at

For MERS:
P.O. Box 2026, Flint, MI 48501-2026

For Lender:
210 N. UNIVERSITY DR STE 601, CORAL SPRINGS, FL 33071

or to such other address as you may designate by notice to us. Any notice provided for in this Mortgage shall be deemed to have been given to us or you when given in the manner designated herein.

RELEASE: Upon payment of all sums secured by this Mortgage and provided the obligation to make further advances under the Note has terminated, you shall discharge this Mortgage without charge to us, except that we shall pay any fees for recording of a satisfaction of this Mortgage.

GENERAL: You can waive or delay enforcing any of your rights under this Mortgage without losing them. Any waiver by you of any provisions of this Mortgage will not be a waiver of that or any other provision on any other occasion.

Initials: 

DOC ID #: 00013884536807006

THIS MORTGAGE has been signed by each of us under seal on the date first above written.

WITNESS:

[Handwritten signatures]

Jean Pierre Jeanglaude
Mortgagor: JEAN B. JEANGLAUDE (SEAL)
11 HEMMING DR
STAFFORD, VA 22554

Gertrude Arthur Jeanglaude
Mortgagor: GERTRUDE ARTHUR JEANGLAUDE (SEAL)
11 HEMMING DR
STAFFORD, VA 22554

Mortgagor: (SEAL)

Mortgagor: (SEAL)

STATE OF ~~FLORIDA~~ ^{Va.} County ss: *Fairfax*
The foregoing instrument was acknowledged before me this August 3, 2006 by
JEAN B. JEANGLAUDE AND GERTRUDE ARTHUR JEANGLAUDE
who is personally known to me or who has produced driver's licenses as identification.

[Signature]
Notary Public *Comm Expires 3/31/07*

Prepared by: YVETTE ZAPATA

GL FINANCIAL SERVICES, LLC.

DATE: 08/03/2006

CASE#:

DOC ID#: 00013884536807006

BORROWER: JEAN B. JEANGLAUE

PROPERTY ADDRESS: 8671 THORNBROOK TERRACE POINT
BOYNTON BEACH, FL 33437

210 N. UNIVERSITY DR STE 601
CORAL SPRINGS, FL 33071
Phone: (954)825-4300
Brk Fax No.: (954)825-4320

LEGAL DESCRIPTION EXHIBIT A

Lot 117, CANYON ISLES PLAT ONE, according to teh plat thereof, as recorded in Plat Book 105 at Page 1 of the Public Records of Palm Beach County, Florida

FHAVA/CONV
Legal Description Exhibit A
2C404-XX (04/03)(d)

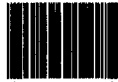

* 2 3 9 9 1 *

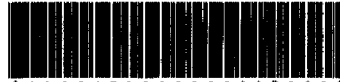

* 1 3 8 8 4 5 3 6 8 0 0 0 0 2 0 8 9 3 *

This is not a certified copy

PLANNED UNIT DEVELOPMENT RIDER

After Recording Return To:
COUNTRYWIDE HOME LOANS, INC.
MS SV-79 DOCUMENT PROCESSING
P.O.Box 10423
Van Nuys, CA 91410-0423

Prepared By:
YVETTE ZAPATA
GL FINANCIAL SERVICES, LLC.

210 N. UNIVERSITY DR STE 7601
CORAL SPRINGS, FL 33071

00013884536807006
[Doc ID #]

THIS PLANNED UNIT DEVELOPMENT RIDER is made this THIRD day of AUGUST, 2006, and is incorporated into and shall be deemed to amend and supplement the Mortgage, Deed of Trust, or Security Deed (the "Security Instrument") of the same date, given by the undersigned (the "Borrower") to secure Borrower's Note to GL FINANCIAL SERVICES, LLC.

(the "Lender") of the same date and covering the Property described in the Security Instrument and located at:

8671 THORNBROOK TERRACE POINT
BOYNTON BEACH, FL 33437
[Property Address]

The Property includes, but is not limited to, a parcel of land improved with a dwelling, together with

MULTISTATE PUD RIDER - Single Family - Fannie Mae/Freddie Mac UNIFORM INSTRUMENT
VMS-7R (0405) CHL (06/04)(d) Page 1 of 3 Initials: *GAJ*
VMP Mortgage Solutions, Inc. (800)521-7291 Form 3150 /01



This document is not a contract.

DOC ID #: 00013884536807006

other such parcels and certain common areas and facilities, as described in THE COVENANTS, CONDITIONS, AND RESTRICTIONS FILED OF RECORD THAT AFFECT THE PROPERTY

ORB 19820, PG 216

(the "Declaration"). The Property is a part of a planned unit development known as CANYON ISLES

[Name of Planned Unit Development]

(the "PUD"). The Property also includes Borrower's interest in the homeowners association or equivalent entity owning or managing the common areas and facilities of the PUD (the "Owners Association") and the uses, benefits and proceeds of Borrower's interest.

PUD COVENANTS. In addition to the covenants and agreements made in the Security Instrument, Borrower and Lender further covenant and agree as follows:

A. PUD Obligations. Borrower shall perform all of Borrower's obligations under the PUD's Constituent Documents. The "Constituent Documents" are the (i) Declaration; (ii) articles of incorporation, trust instrument or any equivalent document which creates the Owners Association; and (iii) any by-laws or other rules or regulations of the Owners Association. Borrower shall promptly pay, when due, all dues and assessments imposed pursuant to the Constituent Documents.

B. Property Insurance. So long as the Owners Association maintains, with a generally accepted insurance carrier, a "master" or "blanket" policy insuring the Property which is satisfactory to Lender and which provides insurance coverage in the amounts (including deductible levels), for the periods, and against loss by fire, hazards included within the term "extended coverage," and any other hazards, including, but not limited to, earthquakes and floods, for which Lender requires insurance, then: (i) Lender waives the provision in Section 3 for the Periodic Payment to Lender of the yearly premium installments for property insurance on the Property; and (ii) Borrower's obligation under Section 5 to maintain property insurance coverage on the Property is deemed satisfied to the extent that the required coverage is provided by the Owners Association policy.

What Lender requires as a condition of this waiver can change during the term of the loan.

Borrower shall give Lender prompt notice of any lapse in required property insurance coverage provided by the master or blanket policy.

In the event of a distribution of property insurance proceeds in lieu of restoration or repair following a loss to the Property, or to common areas and facilities of the PUD, any proceeds payable to Borrower are hereby assigned and shall be paid to Lender. Lender shall apply the proceeds to the sums secured by the Security Instrument, whether or not then due, with the excess, if any, paid to Borrower.

C. Public Liability Insurance. Borrower shall take such actions as may be reasonable to insure that the Owners Association maintains a public liability insurance policy acceptable in form, amount, and extent of coverage to Lender.

D. Condemnation. The proceeds of any award or claim for damages, direct or consequential, payable to Borrower in connection with any condemnation or other taking of all or any part of the Property or the common areas and facilities of the PUD, or for any conveyance in lieu of condemnation, are hereby assigned and shall be paid to Lender. Such proceeds shall be applied by Lender to the sums secured by the Security Instrument as provided in Section 11.

E. Lender's Prior Consent. Borrower shall not, except after notice to Lender and with Lender's prior written consent, either partition or subdivide the Property or consent to: (i) the abandonment or termination of the PUD, except for abandonment or termination required by law in the case of substantial destruction by fire or other casualty or in the case of a taking by condemnation or eminent domain; (ii) any amendment to any provision of the "Constituent Documents" if the provision is for the

Initials: JRSJ GAJ Form 3150 1/01

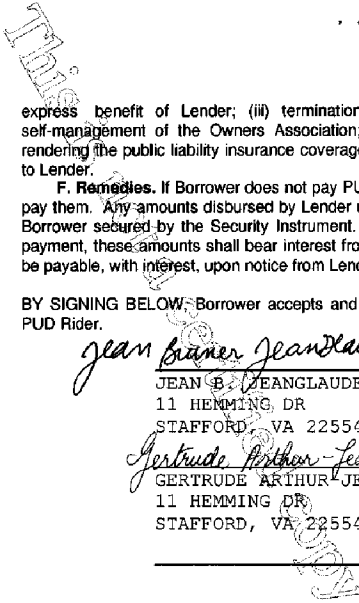

DOC ID #: 00013884536807006

express benefit of Lender; (iii) termination of professional management and assumption of self-management of the Owners Association; or (iv) any action which would have the effect of rendering the public liability insurance coverage maintained by the Owners Association unacceptable to Lender.

F. Remedies. If Borrower does not pay PUD dues and assessments when due, then Lender may pay them. Any amounts disbursed by Lender under this paragraph F shall become additional debt of Borrower secured by the Security Instrument. Unless Borrower and Lender agree to other terms of payment, these amounts shall bear interest from the date of disbursement at the Note rate and shall be payable, with interest, upon notice from Lender to Borrower requesting payment.

BY SIGNING BELOW, Borrower accepts and agrees to the terms and provisions contained in this PUD Rider.

Jean Braxer Jeanglaude

JEAN B. JEANGLAUE
11 HEMMING DR
STAFFORD, VA 22554

(Seal)

- Borrower

Gertrude Arthur Jeanglaude

GERTRUDE ARTHUR JEANGLAUE
11 HEMMING DR
STAFFORD, VA 22554

(Seal)

- Borrower

(Seal)

- Borrower

(Seal)

- Borrower

This is Not a Certified Copy

SECOND HOME RIDER

After Recording Return To:
COUNTRYWIDE HOME LOANS, INC.
MS SV-79 DOCUMENT PROCESSING
P.O.Box 10423
Van Nuys, CA 91410-0423

Prepared By:
YVETTE ZAPATA
GL FINANCIAL SERVICES, LLC.

210 N. UNIVERSITY DR STE 600
CORAL SPRINGS, FL 33071

00013884536807006
[Doc ID #]

THIS SECOND HOME RIDER is made this THIRD day of
AUGUST, 2006, and is incorporated into and shall be deemed to amend and supplement
the Mortgage, Deed of Trust, or Security Deed (the "Security Instrument") of the same date given by the
undersigned (the "Borrower" whether there are one or more persons undersigned) to secure Borrower's Note to
GL FINANCIAL SERVICES, LLC.

(the "Lender") of the same date and covering the Property described in the Security Instrument (the "Property"),
which is located at:

8671 THORNBROOK TERRACE POINT
BOYNTON BEACH, FL 33437
[Property Address]

MULTISTATE SECOND HOME RIDER - Single Family - Fannie Mae/Freddie Mac UNIFORM
INSTRUMENT Page 1 of 2 Initials: [Signature]
VMP-365R (0405) CHL (06/04)(d) Form 3890 1/01
VMP Mortgage Solutions, Inc. (800)521-7291



This document is a legal document and should be read carefully.

DOC ID #: 00013884536807006

In addition to the covenants and agreements made in the Security Instrument, Borrower and Lender further covenant and agree that Sections 6 and 8 of the Security Instrument are deleted and are replaced by the following:

6. Occupancy. Borrower shall occupy, and shall only use, the Property as Borrower's second home. Borrower shall keep the Property available for Borrower's exclusive use and enjoyment at all times, and shall not subject the Property to any timesharing or other shared ownership arrangement or to any rental pool or agreement that requires Borrower either to rent the Property or give a management firm or any other person any control over the occupancy or use of the Property.

8. Borrower's Loan Application. Borrower shall be in default if, during the Loan application process, Borrower or any persons or entities acting at the direction of Borrower or with Borrower's knowledge or consent gave materially false, misleading, or inaccurate information or statements to Lender (or failed to provide Lender with material information) in connection with the Loan. Material representations include, but are not limited to, representations concerning Borrower's occupancy of the Property as Borrower's second home.

BY SIGNING BELOW, Borrower accepts and agrees to the terms and provisions contained in this Second Home Rider.

Jean Bourne Jean Claude

_____(Seal)
JEAN B. JEANGLAUDE
11 HEMMING DR
STAFFORD, VA 22554
- Borrower

Gertrude Arthur - Jean Claude

_____(Seal)
GERTRUDE ARTHUR - JEANGLAUDE
11 HEMMING DR
STAFFORD, VA 22554
- Borrower

_____(Seal)
- Borrower

_____(Seal)
- Borrower



Document Prepared By:
Stephan L. Galiano
ReconTrust Company, N.A.
1330 W. Southern Ave.
MS: TPSA-88
Tempe, AZ 85282-4545
(800) 540-2684

CFN 20070183108
OR BK 21628 PG 0225
RECORDED 04/16/2007 15:01:26
Palm Beach County, Florida
Sharon R. Bock, CLERK & COMPTROLLER
Pg 0225; (1pg)

When recorded return to:
JEAN B JEANGLAUE, GERTRUDE ARTHUR-JEANGLAUE
11 Hemming Dr
Stafford, VA 22554

DOCID#0001388453782005N

SATISFACTION OF MORTGAGE

KNOW ALL MEN BY THESE PRESENTS: Mortgage Electronic Registration Systems, Inc. the owner and holder of a certain mortgage deed executed by JEAN B JEANGLAUE, GERTRUDE ARTHUR-JEANGLAUE to Mortgage Electronic Registration Systems, Inc. bearing date 08/03/2006, recorded on 08/08/2006 in Official Records Book OR 20706, Page 0327, Instrument # 20060482328 in the office of the Clerk of the Circuit Court of PALM BEACH County State of Florida, securing a certain note in the principal sum of \$850,000.00 Dollars, and certain promises and obligations set forth in said mortgage deed, upon the property situated in said State and County hereby acknowledge full payment and satisfaction of said note and mortgage deed, and surrenders the same as canceled, and hereby directs the Clerk of the said Circuit Court to cancel the same of record.

(CORPORATE SEAL)

IN WITNESS WHEREOF the said Corporation has caused these presents to be executed in its name, and its corporate seal to be hereunto affixed, by its proper officers thereunto duly authorized, the 04 day of April, 2007.

Mortgage Electronic Registration Systems, Inc.

ATTEST
Melissa Van Blarcom
Assistant Secretary

Signed and delivered in the presence of:

Alexandria Redfin
Witness

By
Stacey Shirra
Assistant Secretary

STATE OF ARIZONA
COUNTY OF MARICOPA

On 04/04/2007, before me, Christine Jones, Notary Public, personally appeared Stacey Shirra personally known to me (or proved to me on the basis of satisfactory evidence) to be the person whose name is subscribed to the within instrument and acknowledged to me that he/she executed the same in his/her authorized capacity, and that by his/her signature on the instrument the person, or the entity upon behalf of which the person acted, executed the instrument.

Witness my hand and official seal.

Christine Jones, Notary Public
Expires: 12/21/2009



Document Prepared By:
Steven U. Gallano
ReconTrust Company, N.A.
1330 W. Southern Ave.
MS: TPSA-88
Tempe, AZ 85282-4545
(800) 540-2684

CFN 20070185466
OR BK 21632 PG 1381
RECORDED 04/17/2007 14:52:07
Palm Beach County, Florida
Sharon R. Bock, CLERK & COMPTROLLER
Pg 1381; (1pg)

When recorded return to:
JEAN B JEANGLAUDE, GERTRUDE ARTHUR-JEANGLAU
11 HEMMING DRIVE
STAFFORD, VA 22554

DOCID#0001368453682005N

SATISFACTION OF MORTGAGE

KNOW ALL MEN BY THESE PRESENTS: Mortgage Electronic Registration Systems, Inc. the owner and holder of a certain mortgage deed executed by JEAN B JEANGLAUDE, GERTRUDE ARTHUR-JEANGLAU to Mortgage Electronic Registration Systems, Inc. bearing date 08/03/2006, recorded on 08/08/2006 in Official Records Book 20706, Page 0344, Instrument # 20060462329 in the office of the Clerk of the Circuit Court of PALM BEACH County State of Florida, securing a certain note in the principal sum of \$141,120.00 Dollars, and certain promises and obligations set forth in said mortgage deed, upon the property situated in said State and County hereby acknowledge full payment and satisfaction of said note and mortgage deed, and surrenders the same as canceled, and hereby directs the Clerk of the said Circuit Court to cancel the same of record.

(CORPORATE SEAL)

IN WITNESS WHEREOF the said Corporation has caused these presents to be executed in its name, and its corporate seal to be hereunto affixed, by its proper officers thereunto duly authorized, the 03 day of April, 2007.

Mortgage Electronic Registration Systems, Inc.

ATTEST:

Roxanne Bermea
Roxanne Bermea
Assistant Secretary

Signed and delivered in the presence of:

Monica Castro
Monica Castro
Witness

By

Peter Lopez
Peter Lopez
Assistant Secretary

STATE OF ARIZONA
COUNTY OF MARICOPA

On 04/03/2007, before me, Mary H. Doyle, Notary Public, personally appeared Peter Lopez personally known to me (or proved to me on the basis of satisfactory evidence) to be the person whose name is subscribed to the within instrument and acknowledged to me that he/she executed the same in his/her authorized capacity, and that by his/her signature on the instrument the person, or the entity upon behalf of which the person acted, executed the instrument.

Witness my hand and official seal.

Mary H. Doyle
Mary H. Doyle, Notary Public
Expires: 08/18/2009





Recording Requested by &
When Recorded Return To:
US Recordings, Inc.
PO Box 19989
Louisville, KY 40259

CFN 20070188785
OR BK 21639 PG 1219
RECORDED 04/19/2007 08:35:21
Palm Beach County, Florida
AMT 807,000.00
Deed Doc 2,824.50
Intang 1,614.00
Sharon R. Bock, CLERK & COMPTROLLER
Pgs 1219 - 1236; (18pgs)

This document was prepared by
KATHER MCLAUGHLIN
COUNTRYWIDE HOME LOANS, INC.
2380 PERFORMANCE DR MSRGV
C931
RICHARDSON
TX 75082

[Space Above This Line For Recording Data]

38337630

165970934

00016597093403007

(Escrow/Closing #)

(Doc ID #)

MORTGAGE

MIN 1000157 0007938670 7

T007-040958
DMR/NREIS

DEFINITIONS

Words used in multiple sections of this document are defined below and other words are defined in Sections 3, 11, 13, 18, 20 and 21. Certain rules regarding the usage of words used in this document are also provided in Section 16.

(A) "Security Instrument" means this document, which is dated MARCH 30, 2007, together with all Riders to this document.

(B) "Borrower" is

JEAN BRONER JEANGLAUDE, AND GERTRUDE ARTHUR-JEANGLAUDE, HUSBAND AND WIFE

Borrower is the mortgagor under this Security Instrument.

(C) "MERS" is Mortgage Electronic Registration Systems, Inc. MERS is a separate corporation that is acting solely as a nominee for Lender and Lender's successors and assigns. MERS is the mortgagee under this Security Instrument. MERS is organized and existing under the laws of Delaware, and has an address and telephone number of P.O. Box 2026, Fint, MI 48301-2026, tel. (888) 679-MERS.

(D) "Lender" is

COUNTRYWIDE HOME LOANS, INC.

Lender is a CORPORATION

organized and existing under the laws of NEW YORK

Lender's address is

4500 Park Granada MSN# 5VB-314, Calabasas, CA 91302-1613

(E) "Note" means the promissory note signed by Borrower and dated MARCH 30, 2007. The

Note states that Borrower owes Lender

EIGHT HUNDRED SEVEN THOUSAND and 00/100

Dollars (U.S. \$ 807,000.00) plus interest. Borrower has promised to pay this debt in regular

Periodic Payments and to pay the debt in full not later than APRIL 01, 2037

(F) "Property" means the property that is described below under the heading "Transfer of Rights in the

Property."

FLORIDA-Single Family-Fannie Mae/Freddie Mac UNIFORM INSTRUMENT WITH MERS

Page 1 of 11

SA(FL) (0005)

CHL (08/05)(d)

VMP Mortgage Solutions, Inc. (800)821-7291

Form 3010 1/01

CONVVA

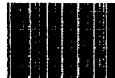

* 2 3 9 9 1 *

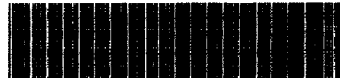

* 1 6 5 9 7 0 9 3 4 0 0 0 0 0 2 0 0 6 A *

Handwritten initials: ARJ, WPS

This is a copy of the original document.

DOC ID #: 00016597093403007

(G) "Loan" means the debt evidenced by the Note, plus interest, any prepayment charges and late charges due under the Note, and all sums due under this Security Instrument, plus interest.

(H) "Riders" means all Riders to this Security Instrument that are executed by Borrower. The following Riders are to be executed by Borrower (check box as applicable):

- Adjustable Rate Rider
- Balloon Rider
- VA Rider
- Condominium Rider
- Planned Unit Development Rider
- Biweekly Payment Rider
- Second Home Rider
- 1-4 Family Rider
- Other(s) (specify)

(I) "Applicable Law" means all controlling applicable federal, state and local statutes, regulations, ordinances and administrative rules and orders (that have the effect of law) as well as all applicable final, non-applicable judicial opinions.

(J) "Community Association Dues, Fees, and Assessments" means all dues, fees, assessments and other charges that are imposed on Borrower or the Property by a condominium association, homeowners association or similar organization.

(K) "Electronic Funds Transfer" means any transfer of funds, other than a transaction originated by check, draft, or similar paper instrument, which is initiated through an electronic terminal, telephonic instrument, computer, or magnetic tape so as to order, instruct, or authorize a financial institution to debit or credit an account. Such term includes, but is not limited to, point-of-sale transfers, automated teller machine transactions, transfers initiated by telephone, wire transfers, and automated clearinghouse transfers.

(L) "Escrow Items" means those items that are described in Section 3.

(M) "Miscellaneous Proceeds" means any compensation, settlement, award of damages, or proceeds paid by any third party (other than insurance proceeds paid under the coverages described in Section 5) for: (i) damage to, or destruction of, the Property; (ii) condemnation or other taking of all or any part of the Property; (iii) conveyance in lieu of condemnation; or (iv) misrepresentations of, or omissions as to, the value and/or condition of the Property.

(N) "Mortgage Insurance" means insurance protecting Lender against the nonpayment of, or default on, the Loan.

(O) "Periodic Payment" means the regularly scheduled amount due for (i) principal and interest under the Note, plus (ii) any amounts under Section 3 of this Security Instrument.

(P) "RESPA" means the Real Estate Settlement Procedures Act (12 U.S.C. Section 2601 et seq.) and its implementing regulation, Regulation X (24 C.F.R. Part 3500), as they might be amended from time to time, or any additional or successor legislation or regulation that governs the same subject matter. As used in this Security Instrument, "RESPA" refers to all requirements and restrictions that are imposed in regard to a "federally related mortgage loan" even if the Loan does not qualify as a "federally related mortgage loan" under RESPA.

(Q) "Successor in Interest of Borrower" means any party that has taken title to the Property, whether or not that party has assumed Borrower's obligations under the Note and/or this Security Instrument.

TRANSFER OF RIGHTS IN THE PROPERTY

This Security Instrument secures to Lender: (i) the repayment of the Loan, and all renewals, extensions and modifications of the Note; and (ii) the performance of Borrower's covenants and agreements under this Security Instrument and the Note. For this purpose, Borrower does hereby mortgage, grant and convey to MERS (solely as nominee for Lender and Lender's successors and assigns) and to the successors and assigns of MERS, the following described property located in the

COUNTY of PALM BEACH ;
[Type of Recording Jurisdiction] [Name of Recording Jurisdiction]

SEE EXHIBIT "A" ATTACHED HERETO AND MADE A PART HEREOF.

Handwritten initials/signature

06-42-45-32-03-00-1170

DOC ID #: 00016597093403007

Parcel ID Number:

which currently has the address of

8671 THORNBROOK TERRACE PT, BOYNTON BEACH

[Street/City]

Florida 33437-4882 ("Property Address"):

[Zip Code]

TOGETHER WITH all the improvements now or hereafter erected on the property, and all easements, appurtenances, and fixtures now or hereafter a part of the property. All replacements and additions shall also be covered by this Security Instrument. All of the foregoing is referred to in this Security Instrument as the "Property." Borrower understands and agrees that MERS holds only legal title to the interests granted by Borrower in this Security Instrument, but, if necessary to comply with law or custom, MERS (as nominee for Lender and Lender's successors and assigns) has the right to exercise any or all of those interests, including, but not limited to, the right to foreclose and sell the Property; and to take any action required of Lender including, but not limited to, releasing and canceling this Security Instrument.

BORROWER COVENANTS that Borrower is lawfully seized of the estate hereby conveyed and has the right to mortgage, grant and convey the Property and that the Property is unencumbered, except for encumbrances of record. Borrower warrants and will defend generally the title to the Property against all claims and demands, subject to any encumbrances of record.

THIS SECURITY INSTRUMENT combines uniform covenants for national use and non-uniform covenants with limited variations by jurisdiction to constitute a uniform security instrument covering real property.

UNIFORM COVENANTS. Borrower and Lender covenant and agree as follows:

1. Payment of Principal, Interest, Escrow Items, Prepayment Charges, and Late Charges. Borrower shall pay when due the principal of, and interest on, the debt evidenced by the Note and any prepayment charges and late charges due under the Note. Borrower shall also pay funds for Escrow Items pursuant to Section 3. Payments due under the Note and this Security Instrument shall be made in U.S. currency. However, if any check or other instrument received by Lender as payment under the Note or this Security Instrument is returned to Lender unpaid, Lender may require that any or all subsequent payments due under the Note and this Security Instrument be made in one or more of the following forms, as selected by Lender: (a) cash; (b) money order; (c) certified check, bank check, treasurer's check or cashier's check, provided any such check is drawn upon an institution whose deposits are insured by a federal agency, instrumentality, or entity; or (d) Electronic Funds Transfer.

Payments are deemed received by Lender when received at the location designated in the Note or at such other location as may be designated by Lender in accordance with the notice provisions in Section 15. Lender may return any payment or partial payment if the payment or partial payments are insufficient to bring the Loan current. Lender may accept any payment or partial payment insufficient to bring the Loan current, without waiver of any rights hereunder or prejudice to its rights to refuse such payment or partial payments in the future, but Lender is not obligated to apply such payments at the time such payments are accepted. If each Periodic Payment is applied as of its scheduled due date, then Lender need not pay interest on unapplied funds. Lender may hold such unapplied funds until Borrower makes payment to bring the Loan current. If Borrower does not do so within a reasonable period of time, Lender shall either apply such funds or return them to Borrower. If not applied earlier, such funds will be applied to the outstanding principal balance under the Note immediately prior to foreclosure. No offset or claim which Borrower might have now or in the future against Lender shall relieve Borrower from making payments due under the Note and this Security Instrument or performing the covenants and agreements secured by this Security Instrument.

2. Application of Payments or Proceeds. Except as otherwise described in this Section 2, all payments accepted and applied by Lender shall be applied in the following order of priority: (a) interest due under the Note; (b) principal due under the Note; (c) amounts due under Section 3. Such payments shall be applied to each Periodic Payment in the order in which it became due. Any remaining amounts shall be applied first to late charges, second to any other amounts due under this Security Instrument, and then to reduce the principal balance of the Note.

If Lender receives a payment from Borrower for a delinquent Periodic Payment which includes a sufficient amount to pay any late charge due, the payment may be applied to the delinquent payment and the late charge. If more than one Periodic Payment is outstanding, Lender may apply any payment received from Borrower to the repayment of the Periodic Payments if, and to the extent that, each payment can be paid in full. To the extent that any excess exists after the payment is applied to the full payment of one or more Periodic Payments, such excess may be applied to any late charges due. Voluntary prepayments shall be applied first to any prepayment charges and then as described in the Note.

MM GAT

This

DOC ID #: 00016597093403007

Any application of payments, insurance proceeds, or Miscellaneous Proceeds to principal due under the Note shall not extend or postpone the due date, or change the amount, of the Periodic Payments.

3. Funds for Escrow Items. Borrower shall pay to Lender on the day Periodic Payments are due under the Note, until the Note is paid in full, a sum (the "Funds") to provide for payment of amounts due for: (a) taxes and assessments and other items which can attain priority over this Security Instrument as a lien or encumbrance on the Property; (b) leasehold payments or ground rents on the Property, if any; (c) premiums for any and all insurance required by Lender under Section 5; and (d) Mortgage Insurance premiums, if any, or any sums payable by Borrower to Lender in lieu of the payment of Mortgage Insurance premiums in accordance with the provisions of Section 10. These items are called "Escrow Items." At origination or at any time during the term of the Loan, Lender may require that Community Association Dues, Fees, and Assessments, if any, be escrowed by Borrower, and such dues, fees and assessments shall be an Escrow Item. Borrower shall promptly furnish to Lender all notices of amounts to be paid under this Section. Borrower shall pay Lender the Funds for Escrow Items unless Lender waives Borrower's obligation to pay the Funds for any or all Escrow Items. Lender may waive Borrower's obligation to pay to Lender Funds for any or all Escrow Items at any time. Any such waiver may only be in writing. In the event of such waiver, Borrower shall pay directly, when and where payable, the amounts due for any Escrow Items for which payment of Funds has been waived by Lender and, if Lender requires, shall furnish to Lender receipts evidencing such payment within such time period as Lender may require. Borrower's obligation to make such payments and to provide receipts shall for all purposes be deemed to be a covenant and agreement contained in this Security Instrument, as the phrase "covenant and agreement" is used in Section 9, if Borrower is obligated to pay Escrow Items directly, pursuant to a waiver, and Borrower fails to pay the amount due for an Escrow Item, Lender may exercise its rights under Section 9 and pay such amount and Borrower shall then be obligated under Section 9 to repay to Lender any such amount. Lender may revoke the waiver as to any or all Escrow Items at any time by a notice given in accordance with Section 15 and, upon such revocation, Borrower shall pay to Lender all Funds, and in such amounts, that are then required under this Section 3.

Lender may, at any time, collect and hold Funds in an amount (a) sufficient to permit Lender to apply the Funds at the time specified under RESPA, and (b) not to exceed the maximum amount a lender can require under RESPA. Lender shall estimate the amount of Funds due on the basis of current data and reasonable estimates of expenditures of future Escrow items or otherwise in accordance with Applicable Law.

The Funds shall be held in an institution whose deposits are insured by a federal agency, instrumentality, or entity (including Lender, if Lender is an institution whose deposits are so insured) or in any Federal Home Loan Bank. Lender shall apply the Funds to pay the Escrow Items no later than the time specified under RESPA. Lender shall not charge Borrower for holding and applying the Funds, annually analyzing the escrow account, or verifying the Escrow Items, unless Lender pays Borrower interest on the Funds and Applicable Law permits Lender to make such a charge. Unless an agreement is made in writing or Applicable Law requires interest to be paid on the Funds, Lender shall not be required to pay Borrower any interest or earnings on the Funds. Borrower and Lender can agree in writing, however, that interest shall be paid on the Funds. Lender shall give to Borrower, without charge, an annual accounting of the Funds as required by RESPA.

If there is a surplus of Funds held in escrow, as defined under RESPA, Lender shall account to Borrower for the excess funds in accordance with RESPA. If there is a shortage of Funds held in escrow, as defined under RESPA, Lender shall notify Borrower as required by RESPA, and Borrower shall pay to Lender the amount necessary to make up the shortage in accordance with RESPA, but in no more than 12 monthly payments. If there is a deficiency of Funds held in escrow, as defined under RESPA, Lender shall notify Borrower as required by RESPA, and Borrower shall pay to Lender the amount necessary to make up the deficiency in accordance with RESPA, but in no more than 12 monthly payments.

Upon payment in full of all sums secured by this Security Instrument, Lender shall promptly refund to Borrower any Funds held by Lender.

4. Charges; Liens. Borrower shall pay all taxes, assessments, charges, fines, and impositions attributable to the Property which can attain priority over this Security Instrument, leasehold payments or ground rents on the Property, if any, and Community Association Dues, Fees, and Assessments, if any. To the extent that these items are Escrow Items, Borrower shall pay them in the manner provided in Section 3.

Borrower shall promptly discharge any lien which has priority over this Security Instrument unless Borrower: (a) agrees in writing to the payment of the obligation secured by the lien in a manner acceptable to Lender, but only so long as Borrower is performing such agreement; (b) contests the lien in good faith by, or defends against enforcement of the lien in, legal proceedings which in Lender's opinion operate to prevent the enforcement of the lien while those proceedings are pending, but only until such proceedings are concluded; or (c) secures from the holder of the lien an agreement satisfactory to Lender subordinating the lien to this Security Instrument. If Lender determines that any part of the Property is subject to a lien which can attain priority over this Security Instrument, Lender may give Borrower a notice identifying the lien. Within 10 days of the date on which that notice is given, Borrower shall satisfy the lien or take one or more of the actions set forth above in this Section 4.

AAA GAG

This

DOC ID #: 00016597093403007

Lender may require Borrower to pay a one-time charge for a real estate tax verification and/or reporting service used by Lender in connection with this Loan.

5. Property Insurance. Borrower shall keep the improvements now existing or hereafter erected on the Property insured against loss by fire, hazards included within the term "extended coverage," and any other hazards including, but not limited to, earthquakes and floods, for which Lender requires insurance. This insurance shall be maintained in the amounts (including deductible levels) and for the periods that Lender requires. What Lender requires pursuant to the preceding sentences can change during the term of the Loan. The insurance carrier providing the insurance shall be chosen by Borrower subject to Lender's right to disapprove Borrower's choice, which right shall not be exercised unreasonably. Lender may require Borrower to pay, in connection with this Loan, either: (a) a one-time charge for flood zone determination, certification and tracking services; or (b) a one-time charge for flood zone determination and certification services and subsequent charges each time remappings or similar changes occur which reasonably might affect such determination or certification. Borrower shall also be responsible for the payment of any fees imposed by the Federal Emergency Management Agency in connection with the review of any flood zone determination resulting from an objection by Borrower.

If Borrower fails to maintain any of the coverages described above, Lender may obtain insurance coverage, at Lender's option and Borrower's expense. Lender is under no obligation to purchase any particular type or amount of coverage. Therefore, such coverage shall cover Lender, but might or might not protect Borrower, Borrower's equity in the Property, or the contents of the Property, against any risk, hazard or liability and might provide greater or lesser coverage than was previously in effect. Borrower acknowledges that the cost of the insurance coverage so obtained might significantly exceed the cost of insurance that Borrower could have obtained. Any amounts disbursed by Lender under this Section 5 shall become additional debt of Borrower secured by this Security Instrument. These amounts shall bear interest at the Note rate from the date of disbursement and shall be payable, with such interest, upon notice from Lender to Borrower requesting payment.

All insurance policies required by Lender and renewals of such policies shall be subject to Lender's right to disapprove such policies, shall include a standard mortgage clause, and shall name Lender as mortgagee and/or as an additional loss payee. Lender shall have the right to hold the policies and renewal certificates. If Lender requires, Borrower shall promptly give to Lender all receipts of paid premiums and renewal notices. If Borrower obtains any form of insurance coverage, not otherwise required by Lender, for damage to, or destruction of, the Property, such policy shall include a standard mortgage clause and shall name Lender as mortgagee and/or as an additional loss payee.

In the event of loss, Borrower shall give prompt notice to the insurance carrier and Lender. Lender may make proof of loss if not made promptly by Borrower. Unless Lender and Borrower otherwise agree in writing, any insurance proceeds, whether or not the underlying insurance was required by Lender, shall be applied to restoration or repair of the Property, if the restoration or repair is economically feasible and Lender's security is not lessened. During such repair and restoration period, Lender shall have the right to hold such insurance proceeds until Lender has had an opportunity to inspect such Property to ensure the work has been completed to Lender's satisfaction, provided that such inspection shall be undertaken promptly. Lender may disburse proceeds for the repairs and restoration in a single payment or in a series of progress payments as the work is completed. Unless an agreement is made in writing or Applicable Law requires interest to be paid on such insurance proceeds, Lender shall not be required to pay Borrower any interest or earnings on such proceeds. Fees for public adjusters, or other third parties, retained by Borrower shall not be paid out of the insurance proceeds and shall be the sole obligation of Borrower. If the restoration or repair is not economically feasible or Lender's security would be lessened, the insurance proceeds shall be applied to the sums secured by this Security Instrument, whether or not then due, with the excess, if any, paid to Borrower. Such insurance proceeds shall be applied in the order provided for in Section 2.

If Borrower abandons the Property, Lender may file, negotiate and settle any available insurance claim and related matters. If Borrower does not respond within 30 days to a notice from Lender that the insurance carrier has offered to settle a claim, then Lender may negotiate and settle the claim. The 30-day period will begin when the notice is given. In either event, or if Lender acquires the Property under Section 22 or otherwise, Borrower hereby assigns to Lender (a) Borrower's rights to any insurance proceeds in an amount not to exceed the amounts unpaid under the Note or this Security Instrument, and (b) any other of Borrower's rights (other than the right to any refund of unearned premiums paid by Borrower) under all insurance policies covering the Property, insofar as such rights are applicable to the coverage of the Property. Lender may use the insurance proceeds either to repair or restore the Property or to pay amounts unpaid under the Note or this Security Instrument, whether or not then due.

MSJ CAS

This

DOC ID #: 00016597093403007

6. **Occupancy.** Borrower shall occupy, establish, and use the Property as Borrower's principal residence within 60 days after the execution of this Security Instrument and shall continue to occupy the Property as Borrower's principal residence for at least one year after the date of occupancy, unless Lender otherwise agrees in writing, which consent shall not be unreasonably withheld, or unless extenuating circumstances exist which are beyond Borrower's control.

7. **Preservation, Maintenance and Protection of the Property; Inspections.** Borrower shall not destroy, damage or impair the Property, allow the Property to deteriorate or commit waste on the Property. Whether or not Borrower is residing in the Property, Borrower shall maintain the Property in order to prevent the Property from deteriorating or decreasing in value due to its condition. Unless it is determined pursuant to Section 5 that repair or restoration is not economically feasible, Borrower shall promptly repair the Property if damaged to avoid further deterioration or damage. If insurance or condemnation proceeds are paid in connection with damage to, or the taking of, the Property, Borrower shall be responsible for repairing or restoring the Property only if Lender has released proceeds for such purposes. Lender may disburse proceeds for the repairs and restoration in a single payment or in a series of progress payments as the work is completed. If the insurance or condemnation proceeds are not sufficient to repair or restore the Property, Borrower is not relieved of Borrower's obligation for the completion of such repair or restoration.

Lender or its agent may make reasonable entries upon and inspections of the Property. If it has reasonable cause, Lender may inspect the interior of the improvements on the Property. Lender shall give Borrower notice at the time of or prior to such an interior inspection specifying such reasonable cause.

8. **Borrower's Loan Application.** Borrower shall be in default if, during the Loan application process, Borrower or any persons or entities acting at the direction of Borrower or with Borrower's knowledge or consent gave materially false, misleading, or inaccurate information or statements to Lender (or failed to provide Lender with material information) in connection with the Loan. Material representations include, but are not limited to, representations concerning Borrower's occupancy of the Property as Borrower's principal residence.

9. **Protection of Lender's Interest in the Property and Rights Under this Security Instrument.** If (a) Borrower fails to perform the covenants and agreements contained in this Security Instrument, (b) there is a legal proceeding that might significantly affect Lender's interest in the Property and/or rights under this Security Instrument (such as a proceeding in bankruptcy, probate, for condemnation or forfeiture, for enforcement of a lien which may attain priority over this Security Instrument or to enforce laws or regulations), or (c) Borrower has abandoned the Property, then Lender may do and pay for whatever is reasonable or appropriate to protect Lender's interest in the Property and rights under this Security Instrument, including protecting and/or assessing the value of the Property, and securing and/or repairing the Property. Lender's actions can include, but are not limited to: (a) paying any sums secured by a lien which has priority over this Security Instrument; (b) appearing in court; and (c) paying reasonable attorneys' fees to protect its interest in the Property and/or rights under this Security Instrument, including its secured position in a bankruptcy proceeding. Securing the Property includes, but is not limited to, entering the Property to make repairs, change locks, replace or board up doors and windows, drain water from pipes, eliminate building or other code violations or dangerous conditions, and have utilities turned on or off. Although Lender may take action under this Section 9, Lender does not have to do so and is not under any duty or obligation to do so. It is agreed that Lender incurs no liability for not taking any or all actions authorized under this Section 9.

Any amounts disbursed by Lender under this Section 9 shall become additional debt of Borrower secured by this Security Instrument. These amounts shall bear interest at the Note rate from the date of disbursement and shall be payable, with such interest, upon notice from Lender to Borrower requesting payment.

If this Security Instrument is on a leasehold, Borrower shall comply with all the provisions of the lease. If Borrower acquires fee title to the Property, the leasehold and the fee title shall not merge unless Lender agrees to the merger in writing.

10. **Mortgage Insurance.** If Lender required Mortgage Insurance as a condition of making the Loan, Borrower shall pay the premiums required to maintain the Mortgage Insurance in effect. If, for any reason, the Mortgage Insurance coverage required by Lender ceases to be available from the mortgage insurer that previously provided such insurance and Borrower was required to make separately designated payments toward the premiums for Mortgage Insurance, Borrower shall pay the premiums required to obtain coverage substantially equivalent to the Mortgage Insurance previously in effect, at a cost substantially equivalent to the cost to Borrower of the Mortgage Insurance previously in effect, from an alternate mortgage insurer selected by Lender. If substantially equivalent Mortgage Insurance coverage is not available, Borrower shall continue to pay to Lender the amount of the separately designated payments that were due when the insurance coverage ceased to be in effect. Lender will accept, use and retain these payments as a non-refundable loss reserve in lieu of Mortgage Insurance. Such loss reserve shall be non-refundable, notwithstanding the fact that the Loan is ultimately paid in full, and Lender shall not be required to pay Borrower any interest or earnings on such loss reserve. Lender can no longer require loss reserve payments if Mortgage Insurance coverage (in the

My GRS

This

DOC ID #: 00016597093403007

amount and for the period that Lender requires) provided by an insurer selected by Lender again becomes available, is obtained, and Lender requires separately designated payments toward the premiums for Mortgage Insurance. If Lender required Mortgage Insurance as a condition of making the Loan and Borrower was required to make separately designated payments toward the premiums for Mortgage Insurance, Borrower shall pay the premiums required to maintain Mortgage Insurance in effect, or to provide a non-refundable loss reserve, until Lender's requirement for Mortgage Insurance ends in accordance with any written agreement between Borrower and Lender providing for such termination or until termination is required by Applicable Law. Nothing in this Section 10 affects Borrower's obligation to pay interest at the rate provided in the Note.

Mortgage Insurance reimburses Lender (or any entity that purchases the Note) for certain losses it may incur if Borrower does not repay the Loan as agreed. Borrower is not a party to the Mortgage Insurance.

Mortgage insurers evaluate their total risk on all such insurance in force from time to time, and may enter into agreements with other parties that share or modify their risk, or reduce losses. These agreements are on terms and conditions that are satisfactory to the mortgage insurer and the other party (or parties) to these agreements. These agreements may require the mortgage insurer to make payments using any source of funds that the mortgage insurer may have available (which may include funds obtained from Mortgage Insurance premiums).

As a result of these agreements, Lender, any purchaser of the Note, another insurer, any reinsurer, any other entity, or any affiliate of any of the foregoing, may receive (directly or indirectly) amounts that derive from (or might be characterized as) a portion of Borrower's payments for Mortgage Insurance, in exchange for sharing or modifying the mortgage insurer's risk, or reducing losses. If such agreement provides that an affiliate of Lender takes a share of the insurer's risk in exchange for a share of the premiums paid to the insurer, the arrangement is often termed "captive reinsurance." Further:

(a) Any such agreements will not affect the amounts that Borrower has agreed to pay for Mortgage Insurance, or any other terms of the Loan. Such agreements will not increase the amount Borrower will owe for Mortgage Insurance, and they will not entitle Borrower to any refund.

(b) Any such agreements will not affect the rights Borrower has - if any - with respect to the Mortgage Insurance under the Homeowners Protection Act of 1998 or any other law. These rights may include the right to receive certain disclosures, to request and obtain cancellation of the Mortgage Insurance, to have the Mortgage Insurance terminated automatically, and/or to receive a refund of any Mortgage Insurance premiums that were unearned at the time of such cancellation or termination.

11. Assignment of Miscellaneous Proceeds; Forfeiture. All Miscellaneous Proceeds are hereby assigned to and shall be paid to Lender.

If the Property is damaged, such Miscellaneous Proceeds shall be applied to restoration or repair of the Property, if the restoration or repair is economically feasible and Lender's security is not lessened. During such repair and restoration period, Lender shall have the right to hold such Miscellaneous Proceeds until Lender has had an opportunity to inspect such Property to ensure the work has been completed to Lender's satisfaction, provided that such inspection shall be undertaken promptly. Lender may pay for the repairs and restoration in a single disbursement or in a series of progress payments as the work is completed. Unless an agreement is made in writing or Applicable Law requires interest to be paid on such Miscellaneous Proceeds, Lender shall not be required to pay Borrower any interest or earnings on such Miscellaneous Proceeds. If the restoration or repair is not economically feasible or Lender's security would be lessened, the Miscellaneous Proceeds shall be applied to the sums secured by this Security Instrument, whether or not then due, with the excess, if any, paid to Borrower. Such Miscellaneous Proceeds shall be applied in the order provided for in Section 2.

In the event of a total taking, destruction, or loss in value of the Property, the Miscellaneous Proceeds shall be applied to the sums secured by this Security Instrument, whether or not then due, with the excess, if any, paid to Borrower.

In the event of a partial taking, destruction, or loss in value of the Property in which the fair market value of the Property immediately before the partial taking, destruction, or loss in value is equal to or greater than the amount of the sums secured by this Security Instrument immediately before the partial taking, destruction, or loss in value, unless Borrower and Lender otherwise agree in writing, the sums secured by this Security Instrument shall be reduced by the amount of the Miscellaneous Proceeds multiplied by the following fraction: (a) the total amount of the sums secured immediately before the partial taking, destruction, or loss in value divided by (b) the fair market value of the Property immediately before the partial taking, destruction, or loss in value. Any balance shall be paid to Borrower.

In the event of a partial taking, destruction, or loss in value of the Property in which the fair market value of the Property immediately before the partial taking, destruction, or loss in value is less than the amount of the sums secured immediately before the partial taking, destruction, or loss in value, unless Borrower and Lender otherwise agree in writing, the Miscellaneous Proceeds shall be applied to the sums secured by this Security Instrument whether or not the sums are then due.

JMS CMO

This

DOC ID #: 00016597093403097

If the Property is abandoned by Borrower, or if, after notice by Lender to Borrower that the Opposing Party (as defined in the next sentence) offers to make an award to settle a claim for damages, Borrower fails to respond to Lender within 30 days after the date the notice is given, Lender is authorized to collect and apply the Miscellaneous Proceeds either to restoration or repair of the Property or to the sums secured by this Security Instrument, whether or not then due. "Opposing Party" means the third party that owes Borrower Miscellaneous Proceeds or the party against whom Borrower has a right of action in regard to Miscellaneous Proceeds.

Borrower shall be in default if any action or proceeding, whether civil or criminal, is begun that, in Lender's judgment, could result in forfeiture of the Property or other material impairment of Lender's interest in the Property or rights under this Security Instrument. Borrower can cure such a default and, if acceleration has occurred, reinstate as provided in Section 19, by causing the action or proceeding to be dismissed with a ruling that, in Lender's judgment, precludes forfeiture of the Property or other material impairment of Lender's interest in the Property or rights under this Security Instrument. The proceeds of any award or claim for damages that are attributable to the impairment of Lender's interest in the Property are hereby assigned and shall be paid to Lender.

All Miscellaneous Proceeds that are not applied to restoration or repair of the Property shall be applied in the order provided for in Section 7.

12. Borrower Not Released; Forbearance By Lender Not a Waiver. Extension of the time for payment or modification of amortization of the sums secured by this Security Instrument granted by Lender to Borrower or any Successor in Interest of Borrower shall not operate to release the liability of Borrower or any Successors in Interest of Borrower. Lender shall not be required to commence proceedings against any Successor in Interest of Borrower or to refuse to extend time for payment or otherwise modify amortization of the sums secured by this Security Instrument by reason of any demand made by the original Borrower or any Successors in Interest of Borrower. Any forbearance by Lender in exercising any right or remedy including, without limitation, Lender's acceptance of payments from third persons, entities or Successors in Interest of Borrower or in amounts less than the amount then due, shall not be a waiver of or preclude the exercise of any right or remedy.

13. Joint and Several Liability; Co-signers; Successors and Assigns Bound. Borrower covenants and agrees that Borrower's obligations and liability shall be joint and several. However, any Borrower who co-signs this Security Instrument but does not execute the Note (a "co-signer"): (a) is co-signing this Security Instrument only to mortgage, grant and convey the co-signer's interest in the Property under the terms of this Security Instrument; (b) is not personally obligated to pay the sums secured by this Security Instrument; and (c) agrees that Lender and any other Borrower can agree to extend, modify, forbear or make any accommodations with regard to the terms of this Security Instrument or the Note without the co-signer's consent.

Subject to the provisions of Section 18, any Successor in Interest of Borrower who assumes Borrower's obligations under this Security Instrument in writing, and is approved by Lender, shall obtain all of Borrower's rights and benefits under this Security Instrument. Borrower shall not be released from Borrower's obligations and liability under this Security Instrument unless Lender agrees to such release in writing. The covenants and agreements of this Security Instrument shall bind (except as provided in Section 20) and benefit the successors and assigns of Lender.

14. Loan Charges. Lender may charge Borrower fees for services performed in connection with Borrower's default, for the purpose of protecting Lender's interest in the Property and rights under this Security Instrument, including, but not limited to, attorneys' fees, property inspection and valuation fees. In regard to any other fees, the absence of express authority in this Security Instrument to charge a specific fee to Borrower shall not be construed as a prohibition on the charging of such fee. Lender may not charge fees that are expressly prohibited by this Security Instrument or by Applicable Law.

If the Loan is subject to a law which sets maximum loan charges, and that law is finally interpreted so that the interest or other loan charges collected or to be collected in connection with the Loan exceed the permitted limits, then: (a) any such loan charge shall be reduced by the amount necessary to reduce the charge to the permitted limit; and (b) any sums already collected from Borrower which exceeded permitted limits will be refunded to Borrower. Lender may choose to make this refund by reducing the principal owed under the Note or by making a direct payment to Borrower. If a refund reduces principal, the reduction will be treated as a partial prepayment without any prepayment charge (whether or not a prepayment charge is provided for under the Note). Borrower's acceptance of any such refund made by direct payment to Borrower will constitute a waiver of any right of action Borrower might have arising out of such overcharge.

15. Notices. All notices given by Borrower or Lender in connection with this Security Instrument must be in writing. Any notice to Borrower in connection with this Security Instrument shall be deemed to have been given to Borrower when mailed by first class mail or when actually delivered to Borrower's notice address if sent by other means. Notice to any one Borrower shall constitute notice to all Borrowers unless Applicable Law expressly requires otherwise. The notice address shall be the Property Address unless

MSJ GAS

Three

DOC ID #: 00016597093403007

Borrower has designated a substitute notice address by notice to Lender. Borrower shall promptly notify Lender of Borrower's change of address. If Lender specifies a procedure for reporting Borrower's change of address, then Borrower shall only report a change of address through that specified procedure. There may be only one designated notice address under this Security Instrument at any one time. Any notice to Lender shall be given by delivering it or by mailing it by first class mail to Lender's address stated herein unless Lender has designated another address by notice to Borrower. Any notice in connection with this Security Instrument shall not be deemed to have been given to Lender until actually received by Lender. If any notice required by this Security Instrument is also required under Applicable Law, the Applicable Law requirement will satisfy the corresponding requirement under this Security Instrument.

16. Governing Law; Severability; Rules of Construction. This Security Instrument shall be governed by federal law and the law of the jurisdiction in which the Property is located. All rights and obligations contained in this Security Instrument are subject to any requirements and limitations of Applicable Law. Applicable Law might explicitly or implicitly allow the parties to agree by contract or it might be silent, but such silence shall not be construed as a prohibition against agreement by contract. In the event that any provision or clause of this Security Instrument or the Note conflicts with Applicable Law, such conflict shall not affect other provisions of this Security Instrument or the Note which can be given effect without the conflicting provision.

As used in this Security Instrument: (a) words of the masculine gender shall mean and include corresponding neuter words or words of the feminine gender; (b) words in the singular shall mean and include the plural and vice versa; and (c) the word "may" gives sole discretion without any obligation to take any action.

17. Borrower's Copy. Borrower shall be given one copy of the Note and of this Security Instrument.

18. Transfer of the Property or a Beneficial Interest in Borrower. As used in this Section 18, "Interest in the Property" means any legal or beneficial interest in the Property, including, but not limited to, those beneficial interests transferred in a bond for deed, contract for deed, installment sales contract or escrow agreement, the intent of which is the transfer of title by Borrower at a future date to a purchaser.

If all or any part of the Property or any interest in the Property is sold or transferred (or if Borrower is not a natural person and a beneficial interest in Borrower is sold or transferred) without Lender's prior written consent, Lender may require immediate payment in full of all sums secured by this Security Instrument. However, this option shall not be exercised by Lender if such exercise is prohibited by Applicable Law.

If Lender exercises this option, Lender shall give Borrower notice of acceleration. The notice shall provide a period of not less than 30 days from the date the notice is given in accordance with Section 15 within which Borrower must pay all sums secured by this Security Instrument. If Borrower fails to pay these sums prior to the expiration of this period, Lender may invoke any remedies permitted by this Security Instrument without further notice or demand on Borrower.

19. Borrower's Right to Reinstate After Acceleration. If Borrower meets certain conditions, Borrower shall have the right to have enforcement of this Security Instrument discontinued at any time prior to the earliest of: (a) five days before sale of the Property pursuant to any power of sale contained in this Security Instrument; (b) such other period as Applicable Law might specify for the termination of Borrower's right to reinstate; or (c) entry of a judgment enforcing this Security Instrument. Those conditions are that Borrower: (a) pays Lender all sums which then would be due under this Security Instrument and the Note as if no acceleration had occurred; (b) cures any default of any other covenants or agreements; (c) pays all expenses incurred in enforcing this Security Instrument, including, but not limited to, reasonable attorneys' fees, property inspection and valuation fees, and other fees incurred for the purpose of protecting Lender's interest in the Property and rights under this Security Instrument; and (d) takes such action as Lender may reasonably require to assure that Lender's interest in the Property and rights under this Security Instrument, and Borrower's obligation to pay the sums secured by this Security Instrument, shall continue unchanged. Lender may require that Borrower pay such reinstatement sums and expenses in one or more of the following forms, as selected by Lender: (a) cash; (b) money order; (c) certified check, bank check, treasurer's check or cashier's check, provided any such check is drawn upon an institution whose deposits are insured by a federal agency, instrumentality or entity; or (d) Electronic Funds Transfer. Upon reinstatement by Borrower, this Security Instrument and obligations secured hereby shall remain fully effective as if no acceleration had occurred. However, this right to reinstate shall not apply in the case of acceleration under Section 18.

20. Sale of Note; Change of Loan Servicer; Notice of Grievance. The Note or a partial interest in the Note (together with this Security Instrument) can be sold one or more times without prior notice to Borrower. A sale might result in a change in the entity (known as the "Loan Servicer") that collects Periodic Payments due under the Note and this Security Instrument and performs other mortgage loan servicing obligations under the Note, this Security Instrument, and Applicable Law. There also might be one or more changes of the Loan Servicer unrelated to a sale of the Note. If there is a change of the Loan Servicer, Borrower will be given written notice of the change which will state the name and address of the new Loan Servicer, the address to

Handwritten signature

THIS

DOC ID #: 00016597093403007

which payments should be made and any other information RESPA requires in connection with a notice of transfer of servicing. If the Note is sold and thereafter the Loan is serviced by a Loan Servicer other than the purchaser of the Note, the mortgage loan servicing obligations to Borrower will remain with the Loan Servicer or be transferred to a successor Loan Servicer and are not assumed by the Note purchaser unless otherwise provided by the Note purchaser.

Neither Borrower nor Lender may commence, join, or be joined to any judicial action (as either an individual litigant or the member of a class) that arises from the other party's actions pursuant to this Security Instrument or that alleges that the other party has breached any provision of, or any duty owed by reason of, this Security Instrument, until such Borrower or Lender has notified the other party (with such notice given in compliance with the requirements of Section 15) of such alleged breach and afforded the other party hereto a reasonable period after the giving of such notice to take corrective action. If Applicable Law provides a time period which must elapse before certain action can be taken, that time period will be deemed to be reasonable for purposes of this paragraph. The notice of acceleration and opportunity to cure given to Borrower pursuant to Section 22 and the notice of acceleration given to Borrower pursuant to Section 18 shall be deemed to satisfy the notice and opportunity to take corrective action provisions of this Section 20.

21. Hazardous Substances. As used in this Section 21: (a) "Hazardous Substances" are those substances defined as toxic or hazardous substances, pollutants, or wastes by Environmental Law and the following substances: gasoline, kerosene, other flammable or toxic petroleum products, toxic pesticides and herbicides, volatile solvents, materials containing asbestos or formaldehyde, and radioactive materials; (b) "Environmental Law" means federal laws and laws of the jurisdiction where the Property is located that relate to health, safety or environmental protection; (c) "Environmental Cleanup" includes any response action, remedial action, or removal action, as defined in Environmental Law; and (d) an "Environmental Condition" means a condition that can cause, contribute to, or otherwise trigger an Environmental Cleanup.

Borrower shall not cause or permit the presence, use, disposal, storage, or release of any Hazardous Substances, or threaten to release any Hazardous Substances, on or in the Property. Borrower shall not do, nor allow anyone else to do, anything affecting the Property (a) that is in violation of any Environmental Law, (b) which creates an Environmental Condition, or (c) which, due to the presence, use, or release of a Hazardous Substance, creates a condition that adversely affects the value of the Property. The preceding two sentences shall not apply to the presence, use, or storage on the Property of small quantities of Hazardous Substances that are generally recognized to be appropriate to normal residential uses and to maintenance of the Property (including, but not limited to, hazardous substances in consumer products).

Borrower shall promptly give Lender written notice of (a) any investigation, claim, demand, lawsuit or other action by any governmental or regulatory agency or private party involving the Property and any Hazardous Substance or Environmental Law of which Borrower has actual knowledge, (b) any Environmental Condition, including but not limited to, any spilling, leaking, discharge, release or threat of release of any Hazardous Substance, and (c) any condition caused by the presence, use or release of a Hazardous Substance which adversely affects the value of the Property. If Borrower learns, or is notified by any governmental or regulatory authority, or any private party, that any removal or other remediation of any Hazardous Substance affecting the Property is necessary, Borrower shall promptly take all necessary remedial actions in accordance with Environmental Law. Nothing herein shall create any obligation on Lender for an Environmental Cleanup.

NON-UNIFORM COVENANTS. Borrower and Lender further covenant and agree as follows:

22. Acceleration; Remedies. Lender shall give notice to Borrower prior to acceleration following Borrower's breach of any covenant or agreement in this Security Instrument (but not prior to acceleration under Section 18 unless Applicable Law provides otherwise). The notice shall specify: (a) the default; (b) the action required to cure the default; (c) a date, not less than 30 days from the date the notice is given to Borrower, by which the default must be cured; and (d) that failure to cure the default on or before the date specified in the notice may result in acceleration of the sums secured by this Security Instrument, foreclosure by judicial proceeding and sale of the Property. The notice shall further inform Borrower of the right to reinstate after acceleration and the right to assert in the foreclosure proceeding the non-existence of a default or any other defense of Borrower to acceleration and foreclosure. If the default is not cured on or before the date specified in the notice, Lender at its option may require immediate payment in full of all sums secured by this Security Instrument without further demand and may foreclose this Security Instrument by judicial proceeding. Lender shall be entitled to collect all expenses incurred in pursuing the remedies provided in this Section 22, including, but not limited to, reasonable attorneys' fees and costs of title evidence.

23. Release. Upon payment of all sums secured by this Security Instrument, Lender shall release this Security Instrument. Borrower shall pay any recordation costs. Lender may charge Borrower a fee for releasing this Security Instrument, but only if the fee is paid to a third party for services rendered and the charging of the fee is permitted under Applicable Law.

MS 00

DOC ID #: 00016597093403007

24. Attorneys' Fees. As used in this Security Instrument and the Note, attorneys' fees shall include those awarded by an appellate court and any attorneys' fees incurred in a bankruptcy proceeding.

25. Jury Trial Waiver. The Borrower hereby waives any right to a trial by jury in any action, proceeding, claim, or counterclaim, whether in contract or tort, at law or in equity, arising out of or in any way related to this Security Instrument or the Note.

BY SIGNING BELOW, Borrower accepts and agrees to the terms and covenants contained in this Security Instrument and in any Rider executed by Borrower and recorded with it.

Signed, sealed and delivered in the presence of:

Ec Booth Jean Bruner Jeanclaude (Seal)
JEAN BRUNER JEANCLAUDE -Borrower

11 HEMMING DR (Address)
STARFORD, VA 22554

Ec Booth Gertrude Arthur Jeanclaude (Seal)
GERTRUDE ARTHUR-JEANCLAUDE -Borrower

11 HEMMING DR (Address)
STARFORD, VA 22554

____ (Seal)
____ -Borrower

____ (Address)

____ (Seal)
____ -Borrower

____ (Address)

STATE OF FLORIDA, Palm Beach County ss:
The foregoing instrument was acknowledged before me this MARCH 30 2007 by
JEAN B. JEANCLAUDE & GERTRUDE A. JEANCLAUDE

who is personally known to me or who has produced Driver's License as identification.

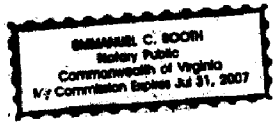

Emmanuel C. Booth
Notary Public
Emmanuel C. Booth

This is not a certified copy

PLANNED UNIT DEVELOPMENT RIDER

After Recording Return To:
COUNTRYWIDE HOME LOANS, INC.
MS SV-78 DOCUMENT PROCESSING
P.O. Box 10483
Van Nuys, CA 91410-0423

Prepared By:
HEATHER MCLAUGHLIN
COUNTRYWIDE HOME LOANS, INC.

2380 PERFORMANCE DR MSRGV
C931
RICHARDSON
TX 75082

165970934 00016597093403007
[Escrow/Closing #] [Doc ID #]

THIS PLANNED UNIT DEVELOPMENT RIDER is made this THIRTIETH day of MARCH, 2007, and is incorporated into and shall be deemed to amend and supplement the Mortgage, Deed of Trust, or Security Deed (the "Security Instrument") of the same date, given by the undersigned (the "Borrower") to secure Borrower's Note to COUNTRYWIDE HOME LOANS, INC.

(the "Lender") of the same date and covering the Property described in the Security Instrument and located at:

8671 THORNBROOK TERRACE PT
BOYNTON BEACH, FL 33437-4882
[Property Address]

The Property includes, but is not limited to, a parcel of land improved with a dwelling, together with

MULTISTATE PUD RIDER - Single Family - Fannie Mae/Freddie Mac UNIFORM INSTRUMENT
VMP® -7R (0405) CHL (06/04)(d) Page 1 of 3 Initials *RM/CAJ*
VMP Mortgage Solutions, Inc. (800)521-7291 Form 3150 1/01



This is Not a Contract

DOC ID #: 00016597093403007

other such parcels and certain common areas and facilities, as described in THE COVENANTS, CONDITIONS, AND RESTRICTIONS FILED OF RECORD THAT AFFECT THE PROPERTY

(the "Declaration"). The Property is a part of a planned unit development known as CANYON ISLES

[Name of Planned Unit Development]

(the "PUD"). The Property also includes Borrower's interest in the homeowners association or equivalent entity owning or managing the common areas and facilities of the PUD (the "Owners Association") and the uses, benefits and proceeds of Borrower's interest.

PUD COVENANTS. In addition to the covenants and agreements made in the Security Instrument, Borrower and Lender further covenant and agree as follows:

A. PUD Obligations. Borrower shall perform all of Borrower's obligations under the PUD's Constituent Documents. The "Constituent Documents" are the (i) Declaration; (ii) articles of incorporation, trust instrument or any equivalent document which creates the Owners Association; and (iii) any by-laws or other rules or regulations of the Owners Association. Borrower shall promptly pay, when due, all dues and assessments imposed pursuant to the Constituent Documents.

B. Property Insurance. So long as the Owners Association maintains, with a generally accepted insurance carrier, a "master" or "blanket" policy insuring the Property which is satisfactory to Lender and which provides insurance coverage in the amounts (including deductible levels), for the periods, and against loss by fire, hazards included within the term "extended coverage," and any other hazards, including, but not limited to, earthquakes and floods, for which Lender requires insurance, then: (i) Lender waives the provision in Section 3 for the Periodic Payment to Lender of the yearly premium installments for property insurance on the Property; and (ii) Borrower's obligation under Section 5 to maintain property insurance coverage on the Property is deemed satisfied to the extent that the required coverage is provided by the Owners Association policy.

What Lender requires as a condition of this waiver can change during the term of the loan.

Borrower shall give Lender prompt notice of any lapse in required property insurance coverage provided by the master or blanket policy.

In the event of a distribution of property insurance proceeds in lieu of restoration or repair following a loss to the Property, or to common areas and facilities of the PUD, any proceeds payable to Borrower are hereby assigned and shall be paid to Lender. Lender shall apply the proceeds to the sums secured by the Security Instrument, whether or not then due, with the excess, if any, paid to Borrower.

C. Public Liability Insurance. Borrower shall take such actions as may be reasonable to insure that the Owners Association maintains a public liability insurance policy acceptable in form, amount, and extent of coverage to Lender.

D. Condemnation. The proceeds of any award or claim for damages, direct or consequential, payable to Borrower in connection with any condemnation or other taking of all or any part of the Property or the common areas and facilities of the PUD, or for any conveyance in lieu of condemnation, are hereby assigned and shall be paid to Lender. Such proceeds shall be applied by Lender to the sums secured by the Security Instrument as provided in Section 11.

E. Lender's Prior Consent. Borrower shall not, except after notice to Lender and with Lender's prior written consent, either partition or subdivide the Property or consent to: (i) the abandonment or termination of the PUD, except for abandonment or termination required by law in the case of substantial destruction by fire or other casualty or in the case of a taking by condemnation or eminent domain; (ii) any amendment to any provision of the "Constituent Documents" if the provision is for the

This

DOC ID #: 00016597093403007

express benefit of Lender; (iii) termination of professional management and assumption of self-management of the Owners Association; or (iv) any action which would have the effect of rendering the public liability insurance coverage maintained by the Owners Association unacceptable to Lender.

F. Remedies. If Borrower does not pay PUD dues and assessments when due, then Lender may pay them. Any amounts disbursed by Lender under this paragraph F shall become additional debt of Borrower secured by the Security Instrument. Unless Borrower and Lender agree to other terms of payment, these amounts shall bear interest from the date of disbursement at the Note rate and shall be payable, with interest, upon notice from Lender to Borrower requesting payment.

BY SIGNING BELOW, Borrower accepts and agrees to the terms and provisions contained in this PUD Rider.

Jean Bruner Jeanglaude (Seal)
JEAN BRUNER JEANGLAUDE - Borrower

11 HEMMING DR
STAFFORD, VA 22554

Gertrude Arthur Jeanglaude (Seal)
GERTRUDE ARTHUR JEANGLAUDE - Borrower

11 HEMMING DR
STAFFORD, VA 22554

____ (Seal)
- Borrower

____ (Seal)
- Borrower

This is not a certified copy

1-4 FAMILY RIDER
(Assignment of Rents)

After Recording Return To:
COUNTRYWIDE HOME LOANS, INC.
MS SV-19 DOCUMENT PROCESSING
P.O. Box 10423
Van Nuys, CA 91410-0423

Prepared By:
HEATHER MCLAUGHLIN
COUNTRYWIDE HOME LOANS, INC.

2380 PERFORMANCE DR MSRGV
C931
RICHARDSON

165970934 00016597093403007
[Escrow/Closing #] [Doc ID #]

THIS 1-4 FAMILY RIDER is made this THIRTIETH day of MARCH, 2007, and is incorporated into and shall be deemed to amend and supplement the Mortgage, Deed of Trust, or Security Deed (the "Security Instrument") of the same date given by the undersigned (the "Borrower") to secure Borrower's Note to COUNTRYWIDE HOME LOANS, INC.

(the "Lender") of the same date and covering the Property described in the Security Instrument and located at:
8671 THORNBROOK TERRACE PT
BOYNTON BEACH, FL 33437-4882
[Property Address]

1-4 FAMILY COVENANTS. In addition to the covenants and agreements made in the Security Instrument, Borrower and Lender further covenant and agree as follows:

MULTISTATE 1-4 FAMILY RIDER - Fannie Mae/Freddie Mac UNIFORM INSTRUMENT
CHL (06/04)(d) Page 1 of 3
VMP Mortgage Solutions, Inc. (800)521-7291

Initials: *RSTO*
LSAT
Form 3170 1/01

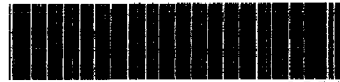

This document is a legal instrument. It is subject to the provisions of the law. It is not to be construed as a contract. It is not to be used as evidence. It is not to be used as a basis for any claim. It is not to be used as a basis for any defense. It is not to be used as a basis for any action. It is not to be used as a basis for any proceeding. It is not to be used as a basis for any hearing. It is not to be used as a basis for any trial. It is not to be used as a basis for any appeal. It is not to be used as a basis for any review. It is not to be used as a basis for any decision. It is not to be used as a basis for any order. It is not to be used as a basis for any judgment. It is not to be used as a basis for any decree. It is not to be used as a basis for any sentence. It is not to be used as a basis for any award. It is not to be used as a basis for any penalty. It is not to be used as a basis for any fine. It is not to be used as a basis for any imprisonment. It is not to be used as a basis for any execution. It is not to be used as a basis for any death. It is not to be used as a basis for any other punishment. It is not to be used as a basis for any other legal consequence. It is not to be used as a basis for any other legal effect. It is not to be used as a basis for any other legal result. It is not to be used as a basis for any other legal outcome. It is not to be used as a basis for any other legal consequence. It is not to be used as a basis for any other legal effect. It is not to be used as a basis for any other legal result. It is not to be used as a basis for any other legal outcome.

DOC ID #: 00016597093403007

A. ADDITIONAL PROPERTY SUBJECT TO THE SECURITY INSTRUMENT. In addition to the Property described in the Security Instrument, the following items now or hereafter attached to the Property to the extent they are fixtures are added to the Property description, and shall also constitute the Property covered by the Security Instrument: building materials, appliances and goods of every nature whatsoever now or hereafter located in, on, or used, or intended to be used in connection with the Property, including, but not limited to, those for the purposes of supplying or distributing heating, cooling, electricity, gas, water, air and light, fire prevention and extinguishing apparatus, security and access control apparatus, plumbing, bath tubs, water heaters, water closets, sinks, ranges, stoves, refrigerators, dishwashers, disposals, washers, dryers, awnings, storm windows, storm doors, screens, blinds, shades, curtains and curtain rods, attached mirrors, cabinets, paneling and attached floor coverings, all of which, including replacements and additions thereto, shall be deemed to be and remain a part of the Property covered by the Security Instrument. All of the foregoing together with the Property described in the Security Instrument (or the leasehold estate if the Security Instrument is on a leasehold) are referred to in this 1-4 Family Rider and the Security Instrument as the "Property."

B. USE OF PROPERTY; COMPLIANCE WITH LAW. Borrower shall not seek, agree to or make a change in the use of the Property or its zoning classification, unless Lender has agreed in writing to the change. Borrower shall comply with all laws, ordinances, regulations and requirements of any governmental body applicable to the Property.

C. SUBORDINATE LIENS. Except as permitted by federal law, Borrower shall not allow any lien inferior to the Security Instrument to be perfected against the Property without Lender's prior written permission.

D. RENT LOSS INSURANCE. Borrower shall maintain insurance against rent loss in addition to the other hazards for which insurance is required by Section 5.

E. "BORROWER'S RIGHT TO REINSTATE" DELETED. Section 19 is deleted.

F. BORROWER'S OCCUPANCY. Unless Lender and Borrower otherwise agree in writing, Section 6 concerning Borrower's occupancy of the Property is deleted.

G. ASSIGNMENT OF LEASES. Upon Lender's request after default, Borrower shall assign to Lender all leases of the Property and all security deposits made in connection with leases of the Property. Upon the assignment, Lender shall have the right to modify, extend or terminate the existing leases and to execute new leases, in Lender's sole discretion. As used in this paragraph G, the word "lease" shall mean "sublease" if the Security Instrument is on a leasehold.

H. ASSIGNMENT OF RENTS; APPOINTMENT OF RECEIVER; LENDER IN POSSESSION. Borrower absolutely and unconditionally assigns and transfers to Lender all the rents and revenues ("Rents") of the Property, regardless of to whom the Rents of the Property are payable. Borrower authorizes Lender or Lender's agents to collect the Rents, and agrees that each tenant of the Property shall pay the Rents to Lender or Lender's agents. However, Borrower shall receive the Rents until: (i) Lender has given Borrower notice of default pursuant to Section 22 of the Security Instrument, and (ii) Lender has given notice to the tenant(s) that the Rents are to be paid to Lender or Lender's agent. This assignment of Rents constitutes an absolute assignment and not an assignment for additional security only.

If Lender gives notice of default to Borrower: (i) all Rents received by Borrower shall be held by Borrower as trustee for the benefit of Lender only, to be applied to the sums secured by the Security Instrument; (ii) Lender shall be entitled to collect and receive all of the Rents of the Property; (iii) Borrower agrees that each tenant of the Property shall pay all Rents due and unpaid to Lender or Lender's agents upon Lender's written demand to the tenant; (iv) unless applicable law provides otherwise, all Rents collected by Lender or Lender's agents shall be applied first to the costs of taking control of and managing the Property and collecting the Rents, including, but not limited to, attorneys' fees, receiver's fees, premiums on receiver's bonds, repair and

THIS IS A COPY

DOC ID #: 00016597093403007

maintenance costs, insurance premiums, taxes, assessments and other charges on the Property, and then to the sums secured by the Security Instrument; (v) Lender, Lender's agents or any judicially appointed receiver shall be liable to account for only those Rents actually received; and (vi) Lender shall be entitled to have a receiver appointed to take possession of and manage the Property and collect the Rents and profits derived from the Property without any showing as to the inadequacy of the Property as security.

If the Rents of the Property are not sufficient to cover the costs of taking control of and managing the Property and of collecting the Rents any funds expended by Lender for such purposes shall become indebtedness of Borrower to Lender secured by the Security Instrument pursuant to Section 9.

Borrower represents and warrants that Borrower has not executed any prior assignment of the Rents and has not performed, and will not perform, any act that would prevent Lender from exercising its rights under this paragraph.

Lender, or Lender's agents or a judicially appointed receiver, shall not be required to enter upon, take control of or maintain the Property before or after giving notice of default to Borrower. However, Lender, or Lender's agents or a judicially appointed receiver, may do so at any time when a default occurs. Any application of Rents shall not cure or waive any default or invalidate any other right or remedy of Lender. This assignment of Rents of the Property shall terminate when all the sums secured by the Security Instrument are paid in full.

I. CROSS-DEFAULT PROVISION. Borrower's default or breach under any note or agreement in which Lender has an interest shall be a breach under the Security Instrument and Lender may invoke any of the remedies permitted by the Security Instrument.

BY SIGNING BELOW, Borrower accepts and agrees to the terms and provisions contained in this 1-4 Family Rider.

Jean Bruner Jeanglaude _____ (Seal)
JEAN BRUNER JEANGLAUDE - Borrower

11 HEMMING DR
STAFFORD, VA 22554
Gertrude Arthur Jeanglaude _____ (Seal)
GERTRUDE ARTHUR-JEANGLAUDE - Borrower

11 HEMMING DR
STAFFORD, VA 22554

(Seal)
- Borrower

(Seal)
- Borrower

EXHIBIT A

SITUATED IN PALM BEACH COUNTY, FLORIDA, THE FOLLOWING DESCRIBED PROPERTY:

LOT 117, CANYON ISLES - PLAT TWO, ACCORDING TO THE PLAT THEREOF, AS RECORDED IN PLAT BOOK 105 AT PAGE 40, OF THE PUBLIC RECORDS OF PALM BEACH COUNTY, FLORIDA.

~~THORN BROOK~~ TERRACE PLACE

ADDRESS: 8671 ~~THORN BROOK~~, BOYNTON BEACH, FL 33437 TAX MAP OR PARCEL ID NO.: 00-42-45-32-03-000-1170

This is not a certified copy



U38332630-01NP18

MORTGAGE

LOAN# 1007-040958

US Recordings

IN THE CIRCUIT COURT FOR PALM BEACH COUNTY, FLORIDA.
CIVIL DIVISION

CASE NO.

THE BANK OF NEW YORK MELLON FKA THE BANK OF NEW YORK, AS TRUSTEE FOR THE CERTIFICATEHOLDERS, CWALT, INC., ALTERNATIVE LOAN TRUST 2007-12T1 MORTGAGE PASS-THROUGH CERTIFICATES, SERIES 2007-12T1,

Plaintiff,
vs.

50 2009 CA027485 XXXX NB

JEAN BRUNER JEANGLAUE; GERTRUDE ARTHUR JEANGLAUE A/K/A GERTRUDE ARTHUR-JEANGLAUE; CANYON ISLES HOMEOWNERS ASSOCIATION, INC.; UNKNOWN TENANT NO. 1; UNKNOWN TENANT NO. 2; and ALL UNKNOWN PARTIES CLAIMING INTERESTS BY, THROUGH, UNDER OR AGAINST A NAMED DEFENDANT TO THIS ACTION, OR HAVING OR CLAIMING TO HAVE ANY RIGHT, TITLE OR INTEREST IN THE PROPERTY HEREIN DESCRIBED,

AM

Defendants.

NOTICE OF LIS PENDENS

NOTICE IS HEREBY GIVEN that suit was instituted in the above styled Court on _____ 2009, by the above styled Plaintiff against the above styled Defendants. The purpose of the suit is to foreclose a certain mortgage upon the following property:

LOT 117, CANYON ISLES - PLAT TWO, ACCORDING TO THE PLAT THEREOF, AS RECORDED IN PLAT BOOK 105 AT PAGE 40, OF THE PUBLIC RECORDS OF PALM BEACH COUNTY, FLORIDA.

All persons are therefore warned and advised of the pendency of this suit.

SMITH, HIATT & DIAZ, P.A.
Attorneys for Plaintiff
PO BOX 11438
Fort Lauderdale, FL 33339-1438
Telephone: (954) 564-0071

B:

Robert A. Smith
Florida Bar No. 116186
Patrice Tedesco
Florida Bar No. 0628451
Gavin MacMillan
Florida Bar No. 0037641
Gabrielle Strauss
Florida Bar No. 0059563
Glenn Matt Lindsay
Florida Bar No. 0059200
Tat-Lin Angus
Florida Bar No. 0051909
Annemarie Bui Tedford
Florida Bar No. 0030143

1183-70318

RECORDED
PALM BEACH COUNTY
CIRCUIT CIVIL
MAR 18 2009
PM 3:19

IN THE CIRCUIT COURT FOR PALM BEACH COUNTY, FLORIDA.
CIVIL DIVISION

CASE NO.

THE BANK OF NEW YORK MELLON FKA THE BANK OF NEW YORK, AS TRUSTEE FOR THE CERTIFICATEHOLDERS, CWALT, INC., ALTERNATIVE LOAN TRUST 2007-12T1 MORTGAGE PASS-THROUGH CERTIFICATES, SERIES 2007-12T1,

Plaintiff,
vs.

50 2009 CA027485 XXXX NB

JEAN BRUNER JEANGLAUDE; GERTRUDE ARTHUR JEANGLAUDE A/K/A GERTRUDE ARTHUR-JEANGLAUDE; CANYON ISLES HOMEOWNERS ASSOCIATION, INC.; UNKNOWN TENANT NO. 1; UNKNOWN TENANT NO. 2; and ALL UNKNOWN PARTIES CLAIMING INTERESTS BY, THROUGH, UNDER OR AGAINST A NAMED DEFENDANT TO THIS ACTION, OR HAVING OR CLAIMING TO HAVE ANY RIGHT, TITLE OR INTEREST IN THE PROPERTY HEREIN DESCRIBED;

AM

Defendants.

NOTICE OF LIS PENDENS

NOTICE IS HEREBY GIVEN that suit was instituted in the above styled Court on _____ 2009, by the above styled Plaintiff against the above styled Defendants. The purpose of the suit is to foreclose a certain mortgage upon the following property:

LOT 117, CANYON ISLES - PLAT TWO, ACCORDING TO THE PLAT THEREOF, AS RECORDED IN PLAT BOOK 105 AT PAGE 40, OF THE PUBLIC RECORDS OF PALM BEACH COUNTY, FLORIDA.

All persons are therefore warned and advised of the pendency of this suit.

SMITH, HIATT & DIAZ, P.A.
Attorneys for Plaintiff
PO BOX 11438
Fort Lauderdale, FL 33339-1438
Telephone: (954) 564-0071

B:

Robert A. Smith
Florida Bar No. 116186
Patrice Tedesco
Florida Bar No. 0628451
Gavin MacMillan
Florida Bar No. 0037641
Gabrielle Strauss
Florida Bar No. 0059563
Glenn Matt Lindsay
Florida Bar No. 0059200
Tat-Lin Angus
Florida Bar No. 0051909
Annemarie Bui Tedford
Florida Bar No. 0030143

1183-70318

RECORDED
PALM BEACH COUNTY
CIRCUIT CIVIL
MAR 17 2009
PM 3:16



CFN 20100076403
OR BK 23715 PG 1415
RECORDED 03/01/2010 08:30:07
Palm Beach County, Florida
AMT 640,000.00
Doc Stamp 4,480.00
Sharon R. Bock, CLERK & COMPTROLLER
Pgs 1415 - 1416; (2pgs)

This document was prepared by and Return to:
MICHAEL A. TRINKLER, ESQ.
MICHAEL A. TRINKLER, P.A.
5501 University Drive, Suite 101
Coral Springs, FL 33067
Phone: (954) 753-5700
Fax No. (954) 753-5767

TRIM COUNTY

(Reserved for Use by the Clerk)

WARRANTY DEED

THIS INDENTURE is made this 5 day of February, 2010, between, JEAN BRUNER JEANGLAUDE and GERTRUDE ARTHUR JEANGLAUDE, husband and wife, party of the first part, and ROMUALD ALTINE and GETOSE ALTINE, husband and wife, whose post office address is: 8671 Thornbrook Terrace Point, Boynton Beach, FL 33437, party of the second part.

WITNESSETH:

That the party of the first part, for and in consideration of the sum of TEN AND NO/100 (\$10.00) DOLLARS to them in hand paid by the party of the second part, the receipt whereof is hereby acknowledged, has granted, bargained and sold to the party of the second part, their heirs and assigns forever, the following described land, situate and being in the County of PALM BEACH and State of Florida, to-wit:

Lot 117, CANYON ISLES - PLAT TWO, according to the plat thereof, as recorded in Plat Book 105 at Page 40, of the Public Records of Palm Beach County, Florida.

Folio No.: 00-42-45-32-03-000-1170

SUBJECT TO:

1. Taxes for the year 2010, and subsequent years;
2. Conditions, restrictions, limitations and easements of record; without reimposing same;
3. Zoning restrictions, prohibitions and other requirements imposed by governmental authority.

And the party of the first part does hereby fully warrant the title to said land, and will defend the same against the lawful claims of all persons whomsoever.

(Reserved for Use by the Clerk)

IN WITNESS WHEREOF, the party of the first part has hereunto set her hand and seal the day and year first above written.

Signed, Sealed and Delivered
In the Presence of:

[Handwritten Signature]

1st Witness Signature

Print Name of 1st Witness: Michelle D. Stearns

Jean Bruner Jeanglaude
JEAN BRUNER JEANGLAUDE

Dayna Solomey

2nd Witness Signature

Print Name of 2nd Witness: Dayna Solomey

Gertrude Arthur Jeanglaude
GERTRUDE ARTHUR JEANGLAUDE

Address: 11 Hemming Drive, Stafford, VA 22554

STATE OF Virginia)
COUNTY OF Stafford) SS:

The execution of the foregoing instrument was acknowledged before me this 5 day of February, 2010 by, JEAN BRUNER JEANGLAUDE and GERTRUDE ARTHUR JEANGLAUDE, who are personally known to me or who have produced VA drivers license as identification, and who did not take an oath.

My Commission Expires: 6/30/10

Karen Barrons

Notary Public

Print Name: Karen Barrons

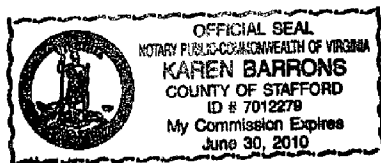

IN THE CIRCUIT COURT FOR PALM BEACH COUNTY, FLORIDA. CIVIL DIVISION

CASE NO. 502009CA027485XXMB(AW)

THE BANK OF NEW YORK MELLON FKA THE BANK OF NEW YORK, AS TRUSTEE FOR THE CERTIFICATEHOLDERS, CWALT, INC., ALTERNATIVE LOAN TRUST 2007-12T1 MORTGAGE PASS-THROUGH CERTIFICATES, SERIES 2007-12T1,

Plaintiff,

vs.

JEAN BRUNER JEANGLAUDE; GERTRUDE ARTHUR JEANGLAUDE A/K/A GERTRUDE ARTHUR-JEANGLAUDE; CANYON ISLES HOMEOWNERS ASSOCIATION, INC.; UNKNOWN TENANT NO. 1; UNKNOWN TENANT NO. 2; and ALL UNKNOWN PARTIES CLAIMING INTERESTS BY, THROUGH, UNDER OR AGAINST A NAMED DEFENDANT TO THIS ACTION, OR HAVING OR CLAIMING TO HAVE ANY RIGHT, TITLE OR INTEREST IN THE PROPERTY HEREIN DESCRIBED,

Defendants.

FILED 2010 JAN 29 PM 4:30 SHARON R. BOCK, CLERK PALM BEACH COUNTY, FL CIVIL DIVISION 1

3-8

SUMMARY FINAL JUDGMENT OF FORECLOSURE

THIS ACTION came before the Court upon pleadings and proofs submitted herein, the motion of the Plaintiff, for the entry of a Summary Final Judgment, and on the evidence presented,

IT IS ADJUDGED THAT:

- 1. This Court has jurisdiction of the subject matter hereof and the parties hereto.

The equities of this action are with the Plaintiff, THE BANK OF NEW YORK MELLON FKA THE BANK OF NEW YORK, AS TRUSTEE FOR THE CERTIFICATEHOLDERS,

CWALT, INC., ALTERNATIVE LOAN TRUST 2007-12T1 MORTGAGE PASS-THROUGH

CERTIFICATES, SERIES 2007-12T1, There is due to the Plaintiff, the sums of money as hereafter set

forth:

| | | | |
|----|--|-----------|-------------------|
| A. | Principal Balance | \$ | 807,000.00 |
| B. | 6.375% interest at \$140.95 per diem from March 1, 2009 thru October 30, 2009 | \$ | 34,097.84 |
| C. | Interest from October 31, 2009 thru January 29, 2010 | | 12,826.45 |
| D. | Advance for Taxes | \$ | 17,066.99 |
| E. | Pre-Acceleration Late Charges | \$ | 643.08 |
| F. | Property Preservation Fees | \$ | 45.00 |
| G. | Title Search | \$ | 325.00 |
| H. | Filing Fee | \$ | 1,963.50 |
| I. | Service of Process | \$ | 475.00 |
| J. | Corporate Search | \$ | 15.00 |
| K. | Attorneys' Fees | \$ | 1,450.00 |
| | TOTAL | \$ | 875,907.86 |

2. Plaintiff is entitled to receive attorney's fees set forth above as compensation for 12 hours reasonably expended at a rate of \$150.00 per hour, as set forth in the filed affidavit. However, pursuant to the Plaintiff's fee agreement with Smith, Hiatt & Diaz, P.A., the Plaintiff will pay attorneys' fees in the amount of \$1450.00.

3. The original promissory note having been presented and delivered to the Court, Count I of Plaintiff's Complaint is hereby deemed moot.

4. A lien is held by the Plaintiff for the total sum specified in paragraph 1, plus interest, superior in dignity to any right, title, interest, or claim of the Defendants upon the mortgaged property herein foreclosed situate, lying and being in Palm Beach County, Florida, to-wit:

LOT 117, CANYON ISLES – PLAT TWO, ACCORDING TO THE PLAT
THEREOF, AS RECORDED IN
PLAT BOOK 105 AT PAGE 40, OF THE PUBLIC RECORDS OF PALM BEACH COUNTY,
FLORIDA.

5. If the total sum due to the Plaintiff, plus interest on the unpaid principal at the rate prescribed in the note and mortgage to date, and at the current statutory interest rate after the date through which interest is calculated in paragraph 1 above, and all costs of this proceeding incurred after the date of this Judgment are not forthwith paid, the Clerk of this Court shall sell that property at public sale at 10:00 a.m. on the 8 day of MARCH, 2010, to the highest bidder or bidders for cash at the www.mypalmbeachclerk.clerkauction.com, after having first given notice as required by Section 45.031, Florida Statutes.

6. Plaintiff shall advance the cost of publishing the Notice of Sale and shall be reimbursed by the Clerk out of the proceeds of the sale if the Plaintiff is not the purchaser of the property, but such reimbursement will not be by the Clerk unless the Affidavit of Post Judgment Advances has been filed. The purchaser at the sale shall pay, in addition to the amount bid, the Clerk's fee, Clerk's registry fee and documentary stamps to be affixed to the Certificate of Title.

7. The Plaintiff may assign the Judgment or the bid to a third party without further order of the Court.

8. If the Plaintiff or Plaintiff's assignee is the purchaser at the sale, the Clerk shall credit on the bid of the Plaintiff or Plaintiff's assignee the total sum herein found to be due the Plaintiff or such portion thereof as may be necessary to pay fully the bid of the Plaintiff or Plaintiff's assignee.

9. On filing the Certificate of Title, the Clerk shall distribute the proceeds of the sale to Plaintiff c/o Smith, Hiatt & Diaz, P.A., PO BOX 11438, Fort Lauderdale, FL 33339-1438, so far as they are sufficient, by paying:

A. All of Plaintiff's costs,

B. Plaintiff's attorneys' fees,

C. The total sum due to Plaintiff as set forth above, less the items paid, with interest

at the current statutory interest rate from the date through which interest is calculated in paragraph 1 above to the date of the sale. If, subsequent to the date of the Plaintiff's Affidavit of Indebtedness and prior to the sale contemplated in paragraph 5 hereof, the Plaintiff has to advance money to protect its mortgage lien, including but not limited to post judgment advances for property taxes and insurance, property preservation costs, post judgment attorney's fees and costs and post judgment bankruptcy attorney fees and costs, the Plaintiff or its Attorneys shall certify by affidavit to the Clerk and the amount due to Plaintiff shall be increased by the amount of such advances upon further order of the Court.

D. The remaining proceeds, if any, shall be retained by the Clerk pending further Order of the Court.

10. If the United States of America is a Defendant in this action, they shall have the right of redemption provided by 28 U.S.C. §2410(c) from the issuance of a Certificate of Title, but the right shall thereafter expire.

11. Upon filing the Certificate of Sale, the Defendants and all persons claiming under or against them since the filing of the Notice of Lis Pendens shall be foreclosed of all estate or claim in the property, with the exception of any assessments that are superior pursuant to Florida Statutes, Section 718.116 (effective 4/1/1992) or Florida Statutes 720.3085 (effective 7/1/2008), both of which state they are not to be applied retroactively to alter a lien priority existing prior to the effective date of the statute. Upon issuance of the Certificate of Title, the purchaser at the sale shall be let into possession of the property located at 8671 THORNBROOK TERRACE PT, BOYNTON BEACH, FL 33437. Upon further order of the court, the Clerk of the Court is hereby specifically authorized to issue a Writ of Possession for the property which is the subject matter of this action, and the Sheriff is hereby authorized

to serve the Writ forthwith .

12. IF THIS PROPERTY IS SOLD AT PUBLIC AUCTION, THERE MAY BE ADDITIONAL MONEY FROM THE SALE AFTER PAYMENT OF PERSONS WHO ARE ENTITLED TO BE PAID FROM THE SALE PROCEEDS PURSUANT TO THIS FINAL JUDGMENT.

13. IF YOU ARE A SUBORDINATE LIENHOLDER CLAIMING A RIGHT TO FUNDS REMAINING AFTER THE SALE, YOU MUST FILE A CLAIM WITH THE CLERK NO LATER THAN 60 DAYS AFTER THE SALE. IF YOU FAIL TO FILE A CLAIM, YOU WILL NOT BE ENTITLED TO ANY REMAINING FUNDS.

14. IF YOU ARE THE PROPERTY OWNER, YOU MAY CLAIM THESE FUNDS YOURSELF. YOU ARE NOT REQUIRED TO HAVE A LAWYER OR ANY OTHER REPRESENTATION AND YOU DO NOT HAVE TO ASSIGN YOUR RIGHTS TO ANYONE ELSE IN ORDER FOR YOU TO CLAIM ANY MONEY TO WHICH YOU ARE ENTITLED. PLEASE CHECK WITH THE CLERK OF THE COURT, OF PALM BEACH COUNTY WITHIN TEN (10) DAYS AFTER THE SALE TO SEE IF THERE IS ADDITIONAL MONEY FROM THE FORECLOSURE SALE THAT THE CLERK HAS IN THE REGISTRY OF THE COURT.

15. IF YOU DECIDE TO SELL YOUR HOME OR HIRE SOMEONE TO HELP YOU CLAIM THE ADDITIONAL MONEY, YOU SHOULD READ VERY CAREFULLY ALL PAPERS YOU ARE REQUIRED TO SIGN, ASK SOMEONE ELSE, PREFERABLY AN ATTORNEY WHO IS NOT RELATED TO THE PERSON OFFERING TO HELP YOU, TO MAKE SURE THAT YOU UNDERSTAND WHAT YOU ARE SIGNING AND THAT YOU ARE NOT TRANSFERRING YOUR PROPERTY OR THE EQUITY IN YOUR PROPERTY WITHOUT THE PROPER INFORMATION. IF YOU CANNOT AFFORD TO PAY AN ATTORNEY, YOU MAY CONTACT THE COUNTY LEGAL AID OFFICE OF FLORIDA RURAL LEGAL SERVICES, 1500 NW AVENUE

"L" UNIT B, BELLE GLADE, FL 33430, PHONE: (888) 993-0003 TO SEE IF YOU QUALIFY FINANCIALLY FOR THEIR SERVICES. IF THEY CANNOT ASSIST YOU, THEY MAY BE ABLE TO REFER YOU TO A LOCAL BAR REFERRAL AGENCY OR SUGGEST OTHER OPTIONS. IF YOU CHOOSE TO CONTACT PALM BEACH COUNTY AID SERVICES FOR ASSISTANCE, YOU SHOULD DO SO AS SOON AS POSSIBLE AFTER RECEIPT OF THIS NOTICE.

16. The Court retains jurisdiction of this action to enter further orders as are proper including, without limitation, deficiency judgments.

DONE AND ORDERED in Chambers at the Palm Beach County Courthouse, West Palm

Beach, Florida on ~~04-17-2007~~ 1-29-2010.

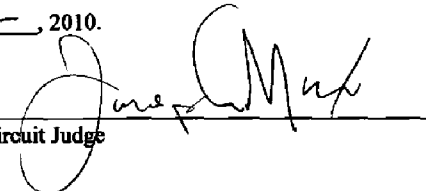
Circuit Judge

Copies furnished:

Gabrielle M Strauss, Esquire
SMITH, HIATT & DIAZ, P.A.
Attorneys for Plaintiff
PO BOX 11438
Fort Lauderdale, FL 33339-1438
Telephone: (954) 564-0071

All parties on the attached service list
1183-70318

SERVICE LIST

Case No. 502009CA027485XXMBAW

JEAN BRUNER JEANGLAUE

11 Hemming Dr
Stafford, VA 22554

GERTRUDE ARTHUR JEANGLAUE

A/K/A GERTRUDE ARTHUR-JEANGLAUE
11 Hemming Dr
Stafford, VA 22554

MICHAEL S. FELDMAN, ESQ

Attorney For CANYON ISLES HOMEOWNERS ASSOCIATION, INC.
6111 BROKEN SOUND PKWY NW, STE 200
BOCA RATON, FL 33487

Unidentified copy



CFN 20100076403
OR BK 23715 PG 1415
RECORDED 03/01/2010 08:30:07
Palm Beach County, Florida
AMT 640,000.00
Doc Stamp 4,480.00
Sharon R. Bock, CLERK & COMPTROLLER
Pgs 1415 - 1416; (2pgs)

This document was prepared by and Return to:
MICHAEL A. TRINKLER, ESQ.
MICHAEL A. TRINKLER, P.A.
5501 University Drive, Suite 101
Coral Springs, FL 33067
Phone: (954) 753-5700
Fax No. (954) 753-5767

TRIM COUNTY

(Reserved for Use by the Clerk)

WARRANTY DEED

THIS INDENTURE is made this 5 day of February, 2010, between, JEAN BRUNER JEANGLAUDE and GERTRUDE ARTHUR JEANGLAUDE, husband and wife, party of the first part, and ROMUALD ALTINE and GETOSE ALTINE, husband and wife, whose post office address is: 8671 Thornbrook Terrace Point, Boynton Beach, FL 33437, party of the second part.

WITNESSETH:

That the party of the first part, for and in consideration of the sum of TEN AND NO/100 (\$10.00) DOLLARS to them in hand paid by the party of the second part, the receipt whereof is hereby acknowledged, has granted, bargained and sold to the party of the second part, their heirs and assigns forever, the following described land, situate and being in the County of PALM BEACH and State of Florida, to-wit:

Lot 117, CANYON ISLES - PLAT TWO, according to the plat thereof, as recorded in Plat Book 105 at Page 40, of the Public Records of Palm Beach County, Florida.

Folio No.: 00-42-45-32-03-000-1170

SUBJECT TO:

1. Taxes for the year 2010, and subsequent years;
2. Conditions, restrictions, limitations and easements of record; without reimposing same;
3. Zoning restrictions, prohibitions and other requirements imposed by governmental authority.

And the party of the first part does hereby fully warrant the title to said land, and will defend the same against the lawful claims of all persons whomsoever.

(Reserved for Use by the Clerk)

IN WITNESS WHEREOF, the party of the first part has hereunto set her hand and seal the day and year first above written.

Signed, Sealed and Delivered
In the Presence of:

[Handwritten Signature]

1st Witness Signature

Print Name of 1st Witness: Michelle D. Stearns

Jean Bruner Jeanglaude
JEAN BRUNER JEANGLAUDE

Dayna Solomey

2nd Witness Signature

Print Name of 2nd Witness: Dayna Solomey

Gertrude Arthur Jeanglaude
GERTRUDE ARTHUR JEANGLAUDE

Address: 11 Hemming Drive, Stafford, VA 22554

STATE OF Virginia)
COUNTY OF Stafford) SS:

The execution of the foregoing instrument was acknowledged before me this 5 day of February, 2010 by, JEAN BRUNER JEANGLAUDE and GERTRUDE ARTHUR JEANGLAUDE, who are personally known to me or who have produced VA drivers license as identification, and who did not take an oath.

My Commission Expires: 6/30/10

Karen Barrons

Notary Public

Print Name: Karen Barrons

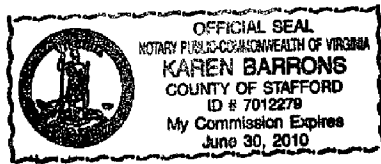



Document Prepared By:
ReconTrust Company, N.A.
2575 W. Chandler Blvd.
Mail Stop: AZ1-804-02-11
Chandler, AZ 85224
(800) 540-2694

CFN 20100187212
OR BK 23857 PG 0153
RECORDED 05/20/2010 09:34:28
Palm Beach County, Florida
Sharon R. Bock, CLERK & COMPTROLLER
Pg 0153; (1pg)

When recorded return to:
JEAN BRUNER JEANGLAUE
11 Hemming Dr.
Stafford
VA 22554

DOC ID#0001659709342005N

SATISFACTION OF MORTGAGE

KNOW ALL MEN BY THESE PRESENTS: Mortgage Electronic Registration Systems, Inc. the owner and holder of a certain mortgage deed executed by JEAN BRUNER JEANGLAUE AND GERTRUDE ARTHUR-JEANGLAUE to Mortgage Electronic Registration Systems, Inc. bearing date 03/30/2007, recorded on 04/19/2007 in Official Records Book OR 21639, Page 1219, Instrument # 20070188785 in the office of the Clerk of the Circuit Court of PALM BEACH County State of Florida, securing a certain note in the principal sum of \$607,000.00 Dollars, and certain promises and obligations set forth in said mortgage deed, upon the property situated in said State and County hereby acknowledge full payment and satisfaction of said note and mortgage deed, and surrenders the same as canceled, and hereby directs the Clerk of the said Circuit Court to cancel the same of record.

(CORPORATE SEAL)

IN WITNESS WHEREOF the said Corporation has caused these presents to be executed in its name, and its corporate seal to be hereunto affixed, by its proper officers thereunto duly authorized, the 9 day of May, 2010.

Mortgage Electronic Registration Systems, Inc.

ATTEST:
[Signature]
DeWayne Vardaman
Assistant Secretary

Signed and delivered in the presence of:

[Signature]
Amy DeLaPaz
Witness

By [Signature]
Icela Lopez
Vice President

STATE OF ARIZONA
COUNTY OF MARICOPA

On 5-4-10 before me, Edward Napier, Notary Public, personally appeared Icela Lopez personally known to me (or proved to me on the basis of satisfactory evidence) to be the person whose name is subscribed to the within instrument and acknowledged to me that he/she executed the same in his/her authorized capacity, and that by his/her signature on the instrument the person, or the entity upon behalf of which the person acted, executed the instrument.

Witness my hand and official seal.

[Signature]
Edward Napier, Notary Public
Expires: 09/14/2013

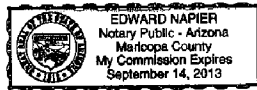

1 **Exhibit 5 - UCAV Distributed Mission Training Testbed:**

2 **Lessons Learned and Future Challenges**

3 by Dr. Dutch Guckenberger and Matt Archer

4 The Interservice/Industry Training, Simulation & Education Conference

5 (I/ITSEC), Volume: 2000 (Conference Theme: Partnerships for Learning in

6 the New Millennium)

7 <http://ntsa.metapress.com/link.asp?id=4mrrc0aupmjpf8e6>

8



[Log out genevahunter](#)

- [Home](#)
- [About](#)
- [Search](#)
- [Volumes](#)
- [Account](#)
- [Subscribe](#)
- [Shopping Cart](#)
- [Order History](#)
- [Profile](#)
- [Services](#)
- [Alerting](#)
- [ActiveSearch](#)
- [Support](#)
- [Contact Us](#)
- [Downloads](#)

Article

[Back To: Search Results](#)



[The Interservice/Industry Training, Simulation & Education Conference \(IITSEC\)](#)

Volume: 2000 (Conference Theme: Partnerships for Learning in the New Millennium)

URL: [Linking Options](#)

UCAV Distributed Mission Training Testbed: Lessons Learned and Future Challenges

Dr. Dutch Guckenberger^{A1} and Matt Archer^{A1}

^{A1} SDS International Inc., Orlando, FL

^{A2} BMH Associates, Inc., Norfolk, VA

Abstract:

The UCAV DMT Testbed research will focus on technologies for: defining effective training strategies for UAV/UCAV operators; assessing the delta in training required for multiple vehicles; advanced displays driven from human factors design; integration of Geneva Aerospace's Variable Autonomy Control System; and integrating several UAV and UCAV Flight Model into the Testbed. Potential applications include direct linkage of UCAV Testbeds as Participants in DMT. This paper chronicles the development of the UCAV DMT Testbed from the perspective of lessons learned and details features planned to support the initial research efforts planned for 2000.

Four successful UCAV DMT demonstrations and experiments are presented from a lessons learned perspective. Starting with the initial separately developed PC-Based UCAV simulations; evolving to the merging of the simulations and initial DMT research experiments including DMTO&I testbed, IITSEC99 and planned AFRL Mesa UCAV DMT Demonstrations. Key testbed components included the LiteFlite Flight Simulator, JSAF and SOAR applications, and the Variable Autonomy Control System (VACS). The unique and innovative portions of this paper detail the components integration for UCAV missions and operational concepts, along with the human factors engineering on the VACS human-system interface design and LiteFlite researcher toolkit interfaces. Illustrative examples, are also included with sufficient details to support other government, industry and academic organizations participation in future UCAV DMT experiments and demonstrations.

Participating organizations include but are not limited to AFRL Mesa, SDS International, Geneva Aerospace, Eglin 46th Test Wing PRIMES, NASA Dryden Flight Research Center/Tuskegee University, Computer Science Corporation. Future participants may include Navy Pax River (MFS and Distributed Simulation Groups), AFRL Wright-Patterson and Naval Aerospace Medical Research Lab. Additional discussion includes related UCAV DMT Research topics of :

- LiteFlite UCAV and Testbed Utilization of the Ordnance Server to ensure DMT Fair Fight
- Innovations associated with a new Distributed Ordnance Server to insure Temporal Correlation of the
- Target/Counter-Measure/Weapon Triad

Full Text Access

Full Text Available

The full text of this article is available. You may view the article as (a):

PDF

The size of this document is 2,135 kilobytes. Although it may be a lengthier download, this is the most authoritative online format.

[Open Full Text](#)

HTML

This offers the quickest access for ease of browsing. Please note that some scientific and mathematical characters may not render as precisely as in PDF versions.

[Open Full Text](#)

• An Innovative new concept of handing off UCAV Ownership from the Virtual LiteFlite Host Simulation to

the Constructive JSAF and SOAR Agents to automate tasks for the UCAV operators Results from three initial UCAV integration efforts are presented detailing DIS integration with existing DMT assets and HLA integration with planned DMT configurations I/TSEC99, USAF Only DMTO&I Demonstration Jan2000, DMT UCAV Testbed development for AFRL/HEA and UAV 2000 Demonstration July 2000. An outline of planned research efforts that will utilize the DMT UCAV Testbed are presented along with Future Research Directions.



Remote Address: 68.190.187.74 • Server: MPWEB03
HTTP User Agent: Mozilla/5.0 (Windows; U; Windows NT 6.0; en-US; rv:1.9.2.3) Gecko/20100401
Firefox/3.6.3 (.NET CLR 3.5.30729)

UCAV Distributed Mission Training Testbed: Lessons Learned and Future Challenges

Dr. Dutch Guckenberger & Matt Archer
SDS International Inc.
Orlando, FL
dutchg@sdslink.com & marcher@sdslink.com

Michael R. Oakes
BMH Associates, Inc.
Norfolk, VA
moakes@bmh.com

Abstract

The UCAV DMT Testbed research will focus on technologies for: defining effective training strategies for UAV/UCAV operators; assessing the delta in training required for multiple vehicles; advanced displays driven from human factors design; integration of Geneva Aerospace's Variable Autonomy Control System; and integrating several UAV and UCAV Flight Model into the Testbed. Potential applications include direct linkage of UCAV Testbeds as Participants in DMT. This paper chronicles the development of the UCAV DMT Testbed from the perspective of lessons learned and details features planned to support the initial research efforts planned for 2000.

Four successful UCAV DMT demonstrations and experiments are presented from a lessons learned perspective. Starting with the initial separately developed PC-Based UCAV simulations; evolving to the merging of the simulations and initial DMT research experiments including DMTO&I testbed, I/ITSEC99 and planned AFRL Mesa UCAV DMT Demonstrations. Key testbed components included the LiteFlite Flight Simulator, JSAF and SOAR applications, and the Variable Autonomy Control System (VACS). The unique and innovative portions of this paper detail the components integration for UCAV missions and operational concepts, along with the human factors engineering on the VACS human-system interface design and LiteFlite researcher toolkit interfaces. Illustrative examples, are also included with sufficient details to support other government, industry and academic organizations participation in future UCAV DMT experiments and demonstrations.

Participating organizations include but are not limited to AFRL Mesa, SDS International, Geneva Aerospace, Eglin 46th Test Wing PRIMES, NASA Dryden Flight Research Center/Tuskegee University, Computer Science Corporation. Future participants may include Navy Pax River (MFS and Distributed Simulation Groups), AFRL Wright-Patterson and Naval Aerospace Medical Research Lab. Additional discussion includes related UCAV DMT Research topics of:

- LiteFlite UCAV and Testbed Utilization of the Ordnance Server to ensure DMT Fair Fight
- Innovations associated with a new Distributed Ordnance Server to insure Temporal Correlation of the Target/Counter-Measure/Weapon Triad
- An Innovative new concept of handing off UCAV Ownership from the Virtual LiteFlite Host Simulation to the Constructive JSAF and SOAR Agents to automate tasks for the UCAV operators

Results from three initial UCAV integration efforts are presented detailing DIS integration with existing DMT assets and HLA integration with planned DMT configurations I/ITSEC99, USAF Only DMTO&I Demonstration Jan2000, DMT UCAV Testbed development for AFRL/HEA and UAV 2000 Demonstration July 2000. An outline of planned research efforts that will utilize the DMT UCAV Testbed are presented along with Future Research Directions.

About the Authors

Dr. Dutch Guckenberger is the Chief Scientist at SDS International, with 15 years of experience in the defense simulation and training systems. He has earned degrees in Computer Science, Physics, & Simulation and Training. Research interests include Distributed Mission Training, High Resolution PC-Based Visual Systems, Above Real-Time Training (ARTT), UAV and UCAV Research. He is a member of ACM, IEEE, Human Factors Society & a Link Foundation Fellow in Advanced Simulation & Training.

Michael Oakes is a Sr. Systems Engineer with BMH Associates, Inc. He was responsible for the evolution and deployment of high priority classified special access required programs. He is a retired USAF fighter pilot with over 20 years of experience in the Pacific, European, and Southwest Asia theaters of operations and is a USAF F-15 Fighter Weapons School Graduate. Mr. Oakes was the WISSARD Lab Test Director for the STOW-97 ACTD. He continues to provide modeling and military domain expertise for Air Synthetic Force development used in JSAF technologies.

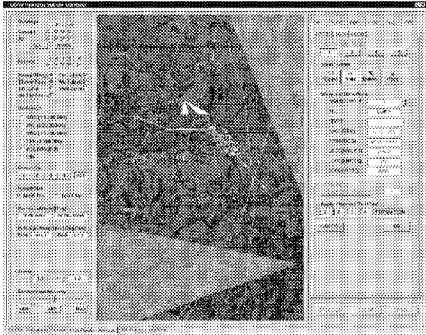

Figure 11. LiteLite UCAV Situational/ MFD Display replicate based upon the original interface developed by WPAFB Operator Vehicle Interface Lab.

It is important to note that the LiteLite image above was developed based upon JPEG images from AFRL/HECP Operator Vehicle Interface (OVI) Group. The key to economically supporting the UCAV researchers is effective rapid prototyping. To this end SDS with their DISTI team partner were able to develop the Situational Display and the major portions of the Multifunction Display to functional prototype level including the DIS connectivity in less than 120 Hours. (See figure 11 above for the prototype UCAV Multifunction Display.)

Variable Autonomy Control System (VACS)

As a portion of the DMT UCAV Testbed development, the Geneva AeroSpace Variable Autonomy Control System (VACS) was added to LiteLite. The VACS is designed to be effective for UAV and UCAV systems as usable to individuals whose training is focused on the requirements of a given mission or the usability of the payload, rather than on the aviation of the vehicle. As the dependence on UAVs for military operations grows and UAV technology is integrated into the emerging global command and control architecture, the cost and complexity of managing and controlling these assets can easily become substantial. The VACS solution to this UAV control problem lies in the appropriate functional allocation between the human and the machine. By merging modern stand-off missile flight control, advanced aircraft flight control, and state-of-the-art communications technologies, Geneva has developed a novel hierarchical flight control structure with varied levels of remote operator input to address the human-machine functional allocation problem.

The VACS has been successfully demonstrated enabling a diverse range of users to effectively operate UAVs. Furthermore, the VACS solution eliminates the requirement for UAVs to be controlled by highly

trained, rated pilots. In a continuing development and demonstration effort VACS is to be used Joint STARS MTE workstation and the Freewing Scorpion 100-50 UAV and conduct a flight test demonstration. This program will demonstrate the benefits of the variable autonomy flight control system design with simplified manual control modes, demonstrate the compatibility of such a system with the military's emerging C⁴I architecture, and demonstrate the synergism between Joint STARS and UAVs using the simplified UAV flight control technology.

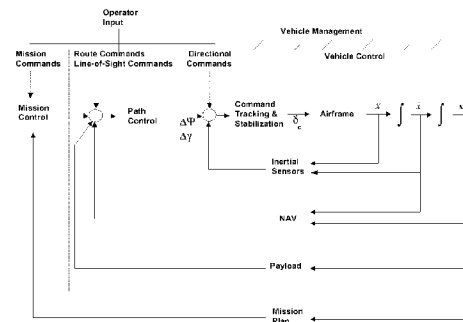

Figure 12. Variable Autonomy Control System (VACS)

JSAF, SOAR & SOAR Speak

Current distributive training technology has evolved towards larger Federations and greater entity resolution. DARPA's STOW has been the only demonstrated large-scale High Level Architecture (HLA) simulation using both large aggregates (for visualization) and entity resolution (for interaction arbitration). Since the October 1997 DoD Advanced Concept Technology Demonstration (ACTD) milestone, STOW has evolved to a viable technology demonstrating high resolution (platform level) simulation to support joint command and staff training, mission visualization capabilities and unit level training. STOW's ability for entity-level resolution has made it an excellent candidate for the USAF Distributed Mission Training (DMT) Program. The STOW Program has evolved into the Joint Semi Autonomous Forces (JSAF) and increased its applications to provide a robust simulation capable of supporting operational training, testing new concepts and doctrine as well as service and joint experimentation issues with direct linkages to real-world C⁴ISR systems in a seamless live, virtual or constructive environment. The current JSAF sponsor is the United States Joint Forces Command (USJFCOM).

1

2

Exhibit 6 - Documents from Geneva Aerospace Trademark Application,

3

Serial Number 78355947 for “Variable Autonomy Control System”

4

From USPTO Trademark Document Retrieval (TDR) Web Site

5

<http://tmportal.uspto.gov/external/portal/tow>

6

Trademark/Service Mark Application, Principal Register

Serial Number: 78355947

Filing Date: 01/22/2004

To the Commissioner for Trademarks:

MARK: (Standard Characters, see mark)

The mark consists of standard characters, without claim to any particular font, style, size, or color.

The literal element of the mark consists of VARIABLE AUTONOMY CONTROL SYSTEM.

The applicant, Geneva Aerospace, Inc., a corporation of Texas, residing at 4312 Sunbelt Dr., Addison, TX, USA, 75001, requests registration of the trademark/service mark identified above in the United States Patent and Trademark Office on the Principal Register established by the Act of July 5, 1946 (15 U.S.C. Section 1051 et seq.), as amended.

The applicant, or the applicant's related company or licensee, is using the mark in commerce, and lists below the dates of use by the applicant, or the applicant's related company, licensee, or predecessor in interest, of the mark on or in connection with the identified goods and/or services. 15 U.S.C. Section 1051(a), as amended.

International Class 009: computer software for autonomous aerial vehicle guidance and control systems

In International Class 009, the mark was first used at least as early as 09/01/1998, and first used in commerce at least as early as 09/01/1998, and is now in use in such commerce. The applicant is submitting or will submit one specimen for *each class* showing the mark as used in commerce on or in connection with any item in the class of listed goods and/or services, consisting of a(n) Portion of company website describing product.

Specimen - 1

The applicant hereby appoints Alexander M. Parker and R. Steven Jones of Jones & Davis, L.L.P., 15851 Dallas Parkway Suite 1220, Addison, TX, USA, 75001 to submit this application on behalf of the applicant. The attorney docket/reference number is Geneva/TM.

The USPTO is authorized to communicate with the applicant or its representative at the following email address: aparker@jonesdavis-law.com.

A fee payment in the amount of \$335 will be submitted with the application, representing payment for 1 class(es).

Declaration

The undersigned, being hereby warned that willful false statements and the like so made are punishable by

1

fine or imprisonment, or both, under 18 U.S.C. Section 1001, and that such willful false statements, and the like, may jeopardize the validity of the application or any resulting registration, declares that he/she is properly authorized to execute this application on behalf of the applicant; he/she believes the applicant to be the owner of the trademark/service mark sought to be registered, or, if the application is being filed under 15 U.S.C. Section 1051(b), he/she believes applicant to be entitled to use such mark in commerce; to the best of his/her knowledge and belief no other person, firm, corporation, or association has the right to use the mark in commerce, either in the identical form thereof or in such near resemblance thereto as to be likely, when used on or in connection with the goods/services of such other person, to cause confusion, or to cause mistake, or to deceive; and that all statements made of his/her own knowledge are true; and that all statements made on information and belief are believed to be true.

Signature: /alexander_parker/ Date: 01/22/2004
Signatory's Name: Alexander M. Parker
Signatory's Position: Attorney

Mailing Address:
Alexander M. Parker
15851 Dallas Parkway Suite 1220
Addison, TX 75001

RAM Sale Number: 513
RAM Accounting Date: 01/23/2004

Serial Number: 78355947
Internet Transmission Date: Thu Jan 22 18:04:09 EST 2004
TEAS Stamp: USPTO/BAS-6419013490-2004012218040973155
8-78355947-20044c21f938bb7a26d3b3c87a1dc
5be85-CC-513-20040122180300429827

2

VARIABLE AUTONOMY CONTROL SYSTEM

1

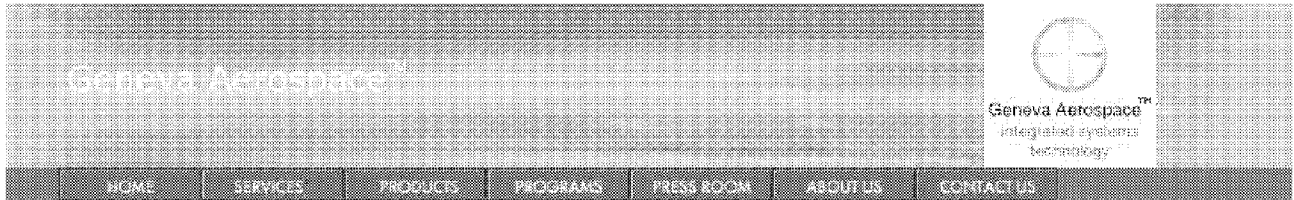

Dakota Unmanned-Aerial Vehicle

Variable Autonomy Control System (VACS)

Low-Cost UAV Avionics Kit

Hi-Fidelity 6DOF Engineering Simulation

400 MHz UAV Flight Termination System

Multi-UAV IP Datalink System

Products: Variable Autonomy Control System (VACS)™

Under Air Force Research Lab funding, Geneva has developed an innovative UAV control design that combines state-of-the-art missile technologies with fixed-wing aircraft control. Our design balances autonomous flight control with manual control to provide variable levels of directional independence and minimizes the personnel and training requirements for the operation of the UAV. The truly enabled UAV operator is not required to be a trained aviator, but still retains a wide range of control flexibility in order to successfully execute the mission objectives that call upon his/her specialized expertise.

Our solution is a hierarchical flight control structure with multiple levels of remote operator input combined with an off-board controller software package and intuitive human system interface. Research of the UAV control problem has indicated that the best solution lies in the appropriate functional allocation between the human and the machine, leading to the organization of the control problem between the two fundamental categories: flight governance and flight management.

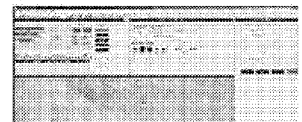
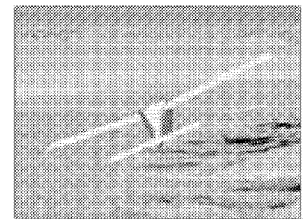
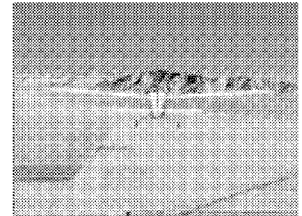

2

3

1 **Exhibit 7** - Documents from Geneva Aerospace Trademark Application,
2 Serial Number 78355939 for “VACS” From USPTO Trademark Document
3 Retrieval Web Site <http://tmportal.uspto.gov/external/portal/tow>

4
5

Serial Number: 78355939

Filing Date: 01/22/2004

To the Commissioner for Trademarks:

MARK: (Standard Characters, see mark)

The mark consists of standard characters, without claim to any particular font, style, size, or color.

The literal element of the mark consists of VACS.

The applicant, Geneva Aerospace, Inc., a corporation of Texas, residing at 4312 Sunbelt Dr., Addison, TX, USA, 75001, requests registration of the trademark/service mark identified above in the United States Patent and Trademark Office on the Principal Register established by the Act of July 5, 1946 (15 U.S.C. Section 1051 et seq.), as amended.

The applicant, or the applicant's related company or licensee, is using the mark in commerce, and lists below the dates of use by the applicant, or the applicant's related company, licensee, or predecessor in interest, of the mark on or in connection with the identified goods and/or services. 15 U.S.C. Section 1051(a), as amended.

International Class 009: computer software for autonomous aerial vehicle guidance and control systems

In International Class 009, the mark was first used at least as early as 09/01/1998, and first used in commerce at least as early as 09/01/1998, and is now in use in such commerce. The applicant is submitting or will submit one specimen for *each class* showing the mark as used in commerce on or in connection with any item in the class of listed goods and/or services, consisting of a(n) Portion of company website describing product.

Specimen - 1

The applicant hereby appoints Alexander M. Parker and R. Steven Jones of Jones & Davis, L.L.P., 15851 Dallas Parkway Suite 1220, Addison, TX, USA, 75001 to submit this application on behalf of the applicant. The attorney docket/reference number is Geneva/TM.

The USPTO is authorized to communicate with the applicant or its representative at the following email address: aparker@jonesdavis-law.com.

A fee payment in the amount of \$335 will be submitted with the application, representing payment for 1 class(es).

Declaration

The undersigned, being hereby warned that willful false statements and the like so made are punishable by fine or imprisonment, or both, under 18 U.S.C. Section 1001, and that such willful false statements, and the like, may jeopardize the validity of the application or any resulting registration, declares that he/she is properly authorized to execute this application on behalf of the applicant; he/she believes the applicant to

1

be the owner of the trademark/service mark sought to be registered, or, if the application is being filed under 15 U.S.C. Section 1051(b), he/she believes applicant to be entitled to use such mark in commerce; to the best of his/her knowledge and belief no other person, firm, corporation, or association has the right to use the mark in commerce, either in the identical form thereof or in such near resemblance thereto as to be likely, when used on or in connection with the goods/services of such other person, to cause confusion, or to cause mistake, or to deceive; and that all statements made of his/her own knowledge are true; and that all statements made on information and belief are believed to be true.

Signature: /alexander_parker/ Date: 01/22/2004
Signatory's Name: Alexander M. Parker
Signatory's Position: Attorney

Mailing Address:
Alexander M. Parker
15851 Dallas Parkway Suite 1220
Addison, TX 75001

RAM Sale Number: 498
RAM Accounting Date: 01/23/2004

Serial Number: 78355939
Internet Transmission Date: Thu Jan 22 17:58:51 EST 2004
TEAS Stamp: USPTO/BAS-6419013490-2004012217585161254
8-78355939-200bbdc8f49b5e5748ffb87cf9e3f
98ff55-CC-498-20040122175614433791

2

VACS

The screenshot shows the Geneva Aerospace website. At the top left is the company name "Geneva Aerospace". To the right is a logo consisting of a circle with a cross inside, and the text "Geneva Aerospace™" and "integrated systems technology" below it. Below the header is a navigation menu with the following items: HOME, SERVICES, PRODUCTS, PROGRAMS, PRESS ROOM, ABOUT US, and CONTACT US.

On the left side of the page, there is a vertical list of product links:

- Dakota Unmanned Aerial Vehicle
- Variable Autonomy Control System (VACS)
- Low-Cost UAV Avionics Kit
- Hi-Fidelity 6DOF Engineering Simulation
- 400 MHz UAV Flight Termination System
- Multi-UAV IP Datalink System

The main content area features the following text:

Products: Variable Autonomy Control System (VACS)™

Under Air Force Research Lab funding, Geneva has developed an innovative UAV control design that combines state-of-the-art missile technologies with fixed-wing aircraft control. Our design balances autonomous flight control with manual control to provide variable levels of directional independence and minimizes the personnel and training requirements for the operation of the UAV. The truly enabled UAV operator is not required to be a trained aviator, but still retains a wide range of control flexibility in order to successfully execute the mission objectives that call upon his/her specialized expertise.

Our solution is a hierarchical flight control structure with multiple levels of remote operator input combined with an off-board controller software package and intuitive human system interface. Research of the UAV control problem has indicated that the best solution lies in the appropriate functional allocation between the human and the machine, leading to the organization of the control problem between the two fundamental categories: flight governance and flight management.

On the right side of the page, there are three images:

- A top-down view of a fixed-wing aircraft on a runway.
- A side view of a fixed-wing aircraft in flight.
- A screenshot of a computer interface, likely the flight control system, showing various data points and controls.

1
2
3
4
5

**Exhibit 8 - Development and Testing of a Variable Autonomy
Control System (VACS) for UAVs**, by Dave Duggan of Geneva
Aerospace and Luis A. Piñeiro of AFRL contained in the
Proceedings AUVSI Symposium, 2002

Development and Testing of a Variable Autonomy Control System (VACS) for UAVs

Dave Duggan
Vice President and Program Manager
Geneva Aerospace
4318 Sunbelt Dr.
Addison, TX 75001
(214) 420-2376 X105
dduggan@genaero.com

Luis A. Piñeiro
Air Force Program Manager
Air Force Research Laboratory
Integration and Demonstration Branch
AFRL/VAAI
2130 8th St. STE 1
WPAFB OH 45433-7542
(937) 255-2857
Luis.Pineiro@wpafb.af.mil

Abstract

As the role of UAVs expands throughout the DOD, increased consideration must be given to reduce cost and complexity of managing and controlling UAVs. First generation control schemes focus on either manual control (remote pilot-in-the-loop) or fully autonomous (pre-programmed) control. These schemes impose significant personnel and training requirements on one side, or increased logistics (mission planning and asset allocation) on the other. The objective of the Variable Autonomy Control System™ (VACS) program is to improve real-time control capability for UAVs by allowing autonomous route following capability (as it exists in current Air Force UAV systems) while providing for dynamic real-time control to deviate from pre-planned routes to accomplish a wide variety of tasks; and reduce human workload requirements significantly below that of existing UAV systems, thus allowing a single operator to effectively manage and control multiple UAVs as opposed to multiple operators per single UAV. The VACS architecture

provides for varying levels of control autonomy, from fully autonomous control to simplified manual flight control modes, and provides a flexible and simple user interface with a much smaller logistical footprint. Furthermore, the VACS design facilitates manned and unmanned systems interoperability as will be demonstrated in follow-on initiatives.

This paper describes the approach to the system's architecture and design, as well as the testing accomplished to date to validate its capabilities. The effectiveness of the system was evaluated recently in a series of flight demonstrations.

Background

Although first generation military UAVs have an impressive set of capabilities, real-time control capability may have been somewhat limited by the need to pre-program routes for totally automated platforms, or the need to have rated pilots assigned in non-flying tours of duty to deal with manually controlled assets. Rarely,

however, do real-world missions go exactly as planned. There are time-critical targets that pop up; traffic conflicts with manned aircraft; clouds that get in the way of EO/IR sensors; and, intelligent and devious adversaries who make target location and identification difficult. Real-time control is required to deviate from the planned route to find and identify new targets; to maneuver UAVs to avoid traffic; to fly under the weather; and to get better line-of-sight angles. Skilled pilots can maneuver aircraft, but then an additional operator is necessary to manage the sensors and the dynamic mission. Likewise, as the dependence on UAVs for military operations grows and UAV technology is integrated into the emerging global command and control architecture, the cost and complexity of managing and controlling these assets are expected to become substantial. Hence, an integrated flight control/flight management system that allows for, but minimizes, human intervention is necessary for the Joint Services.

The VACS effort was established with the purpose of addressing the aforementioned concerns, thus simplifying UAV operation and control. As its name suggests, the architecture includes varying levels of control autonomy from fully autonomous control to simplified manual flight control modes. The simplified manual modes are designed to address Air Combat Command's stated need for "improved real-time control of UAVs". Along with the need for improved real-time control capabilities,

efforts exist within the Air Force to investigate the benefits of placing the UAV control onboard an aircraft. Doing this would allow a Joint STARS to capture imagery for positive ID of ground targets detected by radar. AWACS controllers could direct UAVs to jam enemy radar (when EA-6B Prowlers are unavailable) or direct UCAVs to attack radar sites. Rivet Joint controllers could maneuver UAVs to gather electronic intelligence. AC-130 gunship crews could maneuver a UAV below the clouds to identify targets and assess damage from a safe distance. These airborne platforms, however, have limited space on board for a crew dedicated to UAV control, and need a "de-skilled" UAV control system for their existing operators to use.

VACS Overview

The VACS architecture is designed to support an emerging generation of autonomous and semi-autonomous air vehicles. The design provides seamless transition between varying levels of control autonomy from fully autonomous control to simplified manual flight control modes. The VACS design evolved from high-performance aircraft and advanced standoff missile flight control technologies. Funding for the variable autonomy control concept was provided under the Small Business Innovative Research (SBIR) program Phase I, Phase II, and Phase III funding vehicles through the Air Force Research Laboratory (AFRL) Human Effectiveness and Air Vehicles Integration Directorates (Reference

1). The VACS is to improve real-time control of UAVs, providing autonomous route following capability (as exists in current Air Force UAV systems) while allowing for dynamic real-time control to:

- Deviate from the planned route
- Find and identify new targets
- Maneuver UAVs to avoid traffic
- Fly under the weather
- Avoid terrain collision and support low altitude terrain following
- Avoid airborne collisions with other manned and unmanned air vehicles
- Get better line-of-sight angles for target identification, bomb damage assessment, and other intelligence gathering missions

The VACS provides the real-time control capability that a flexible, operational UAV system requires to successfully execute a mission, including dynamic sensor control and real-time re-tasking, with human workload requirements significantly below that of existing UAV systems. Currently, the VACS capabilities include:

- Autonomous route navigation with autonomous on-station orbit and target search capabilities
- Real-time route editing
- Mixed/hybrid UAV control, such as execution of programmed, energy efficient

climb to operator selected altitude mixed with autopilot assisted manual turn capability

- Tight integration of the UAV primary imaging sensor with the outer control loop for automatic sensor slave steering
- Simplified manual control allowing for real-time manual directional control capability (horizontal and vertical) with no operator training or aviation experience required
- Photo-realistic synthetic vision display (SVD) technology supporting synthetically enhanced situation awareness for the UAV operator

Additional capabilities currently being *implemented* are:

- Automatic takeoff and landing with no requirement for external aiding/guidance sensors
- Multi-ship control capability allowing a single operator the capability to simultaneously manage and control four or more UAVs at one time
- Digital terrain elevation database (DTED) based automatic ground collision avoidance
- Optical sensor based autonomous air collision avoidance

Each of these technologies is being implemented and flight-tested through multiple Air Force and Navy Autonomous Operations research and development programs that extend through the

summer of FY2003. The significant UAV capability advancements offered by the VACS design are the culmination of leveraging advanced capabilities developed through several Army, Navy, and Air Force programs.

VACS was designed to offer a core autonomous and semi-autonomous air vehicle flight control and multi-modal management software package that facilitates rapid, affordable advancements in UAV automation while maintaining seamless integration of the operator and the UAV(s) at all levels of control automation. Reviewing a structure for generalized intelligent control architecture provides a method of relating the VACS design to such a core software package. Figure 1 shows the mapping between a generalized intelligent controller hierarchy and the VACS architecture. The VACS design is modular and generic in nature. Hence, adaptation of VACS in its entirety or of one or several subcomponents thereof to TCS, VTUAV, TUAV, and other future military UAV systems will be technically trivial and can be done with rapid turn-around for low cost. Geneva is currently engaged in several proprietary programs in which VACS adaptations are under way.

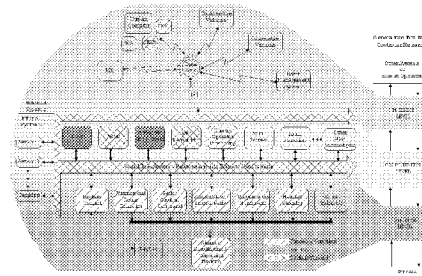

Figure 1 VACS Architecture

A key point to note in the above figure is that the core system architecture, core guidance, navigation, and control algorithms, and major sub-system interfaces are in place. New modules (i.e., new autonomous operations technologies) are added as funding permits. For example, the current AFRL 6.2 program is adding an automatic ground collision system (AutoGCAS, Reference 2). Additionally, an ONR funded Autonomous Operations program is adding an optical sensor-based autonomous “see and avoid” system. Capabilities such as these are modules that “plug” into the core architecture as facilitated by the modular “plug-n-play” design of the VACS system.

The VACS architecture is comprised of airborne management and control functions as well as off-board control interfaces and intuitive human-system interfaces. The off-board control station is comprised of faster-than-real-time simulation capability supporting real-time operator situation awareness and decision aids, intuitive graphical user interfaces and situation displays, and

advanced photo-realistic synthetic vision displays.

The combination of high fidelity synthetic visualization tools (offered by Geneva's industry partner – SDS International), faster than real time simulation technology, and variable autonomy control provides a baseline architecture that is capable of supporting a new level of real-time UAV control and situation awareness. The synthetically enhanced situation awareness system (SESAS) supports real-time management and control of multiple UAVs by a single operator. The synthetic visualization display includes threat data realistically displayed over mapped and photo-realistic 3D terrain. These visuals are driven (dynamically propagated) by a combination of simulated and real UAV data. The simulated data is generated by the ground control station and propagated at a much higher rate than real data is received from the air vehicle. When real data is received, it is used to correct the simulation solution, thus providing an accurate, continuous representation of the UAV flight state within its environment.

The realism afforded by the synthetic visuals significantly enhances the operator's situation awareness. The synthetic visuals offer multiple views (or frames of reference) and increased field-of-view (FOV) over that of on-board sensors. Figure 2 illustrates the concept.

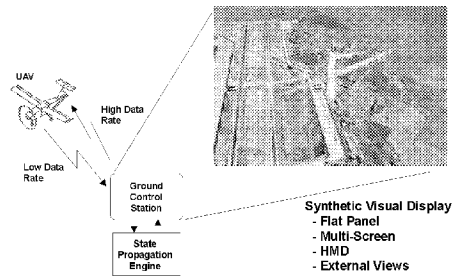

Figure 2 Synthetically Enhanced Situation Awareness Concept

The Synthetically Enhanced Situation Awareness technology can be utilized to provide a wide FOV that augments live video and sensor feeds while *circumventing payload and bandwidth limitations*. Specifically, correlated, photo-realistic 3D terrain can be presented on multiple monitors or flat panel displays to provide a wide area FOV and aid controllers in orientation and situation awareness. Furthermore, this photo-realistic representation of the scene can be viewed from various frames of reference with the simple push of a button.

The synthetic vision based enhanced situation awareness concept was recently demonstrated in a flight test conducted over the Army's 10th Mountain Division Ft. Drum training range located in upstate New York. VIPs in attendance noted the realism of the synthetic visuals with respect to the live video feed transmitted from the UAV.

Significant reductions in datalink bandwidth requirements can be achieved with the aid of the simulation. Background and high frequency update information is provided by the simulation, while low-frequency data specific to the UAV – data that changes in real time over long periods of time – is provided via downlinks. By filling in the high frequency gaps with simulated data, very low update rates over the datalink are made feasible in that the operator is provided with a continuous situation awareness that is comprised of mixed live and simulated data. SESAS addresses two key areas of needed technology improvements in the UAV community: datalink bandwidth and survivability. By significantly reducing the transmission requirements of the air vehicle, UAV detection becomes more difficult, thus increasing system survivability.

VACS Control Modes

The VACS is designed using a flight control architecture that is predominant in the missile industry. The autopilot software design utilizes state-of-the-art flight control techniques, which allow the actuators to dynamically adjust the airframe stabilization properties “on the fly”. The flight computer is programmed directly with the airframe physical properties, so that it can automatically adjust its settings with changes in airframe configuration, aerodynamic properties, or flight state. This provides for a simple and

versatile design, and possesses the critical flexibility needed when adjustments to the airframe configuration become necessary during the course of the program.

The guidance executive manages path regulation and operator inputs and selects the appropriate guidance law to achieve the desired control requirement, supporting varying levels of control from fully autonomous waypoint / route following to fully manual directional control steering. All of the control capability requirements needed to support management and control of multiple UAVs by a single operator are comprehended in the existing VACS design and have been flight proven on Geneva’s Dakota UAV testbed.

The distinguishing aspect of the design is the fluidity with which control levels are transitioned. Through algorithm research and human factors engineering trials, we derived a *trajectory synthesis* based control scheme. This control scheme uses trajectory predictive techniques that allow the operator to effortlessly interact with the control system at any control level from manual through autonomous. The marvel of the control scheme selected, which was derived primarily from advanced missile controls concepts, is its effectiveness in achieving the performance objectives with an uncomplicated, yet advanced, algorithm implementation.

The design is founded on rigorous, tractable mathematical formulations that allow interaction with the operator inputs and allow the operator to instantaneously remove himself from the loop without concern over corresponding vehicle reactions – the vehicle does what the pilot expects. We avoid, however, heuristic techniques (neural networks, artificial intelligence, fuzzy controllers), as they are not needed at this level of control. These techniques will be employed at the observer level for subsystem fault detection in future intelligent autonomy efforts. Consequently, the control system design is robust, predictable, and verifiable. From the UAV perspective, the vehicle that is sent out is the exact same vehicle that returns – a crucial design tenant that allows us to verify safe and predictable performance.

Although human factors played a key role in the design evolution, equally important were robustness, reliability, and affordability. The design features a tolerance to inertial sensor errors and large system latencies. A COTS-based design approach utilizing micro electromechanical systems (MEMS) sensors and commercial grade components was a primary objective in our research. Consequently, the control system design had to provide precision control (e.g., precision path regulation and operator command responsiveness) in the presence of low quality inertial sensors (gyros, accelerometers, pressure transducers) and “sloppy” actuators. The trajectory synthesis

based control solution proved to be robust in the presence of all such sensor errors and subsystem latencies. Mathematically speaking, for example, large inertial measurement unit (IMU) biases wash out in the closed loop at all levels of control. We have demonstrated – in flight tests – precision, highly responsive control (relatively high bandwidth design) with the use of low-grade inertial sensors and low performance actuators.

The VACS implementation currently provides the following set of control modes:

- R/C or Manual Control Mode
- Control-Stick-Steer Mode
- Programmed Maneuver Mode (See Table 1)
- Sensor-Slave Steering Mode
- Waypoint Guidance Mode (See Table 2)
- Park Mode
- Go To Mode (waypoint)
- Return-to-Base (RTB) Mode
- Launch Mode
- Fail-Safe Mode

Table 1: Programmed Maneuvers

| Maneuver | Description |
|-----------|---|
| MAX CL | Climb at maximum climb rate to input altitude |
| BEST CL | Climb at best climb (most efficient) climb rate to input altitude |
| STEEP DEC | Descend at max descent angle to input altitude |
| SHAL DEC | Descend at approach descent angle to input altitude |
| BEST RNG | Cruise at best range speed |
| BEST END | Cruise at best endurance speed |
| MAX (SPD) | Cruise at maximum cruise speed |
| MIN (SPD) | Cruise at minimum speed |
| RT | Turn right an amount equal to the input value |
| LT | Turn left an amount equal to the input value |
| ABS HDG | Turn to the exact heading input |
| DISABLE D | Disable the programmed maneuver |

Table 2 Waypoint Properties

| | |
|-----------------------------|---|
| Event Type | Waypoint, figure 8, racetrack, ellipse (circle is racetrack with equal length and width) |
| Waypoint latitude | Geodetic latitude of waypoint or orbit pattern center |
| Waypoint longitude | Geodetic longitude of waypoint or orbit pattern center |
| Waypoint Altitude | Ellipsoidal altitude of waypoint or orbit pattern center |
| Waypoint Speed | Speed setting at waypoint location |
| Orbit pattern length | Length of desired orbit pattern |
| Orbit pattern width | Width of desired orbit pattern |
| Orbit pattern orientation | Rotation angle of orbit pattern (relative to true North) |
| Number of orbit laps | Desired number of orbit laps |
| Time in orbit | Desired time to maintain orbit pattern (overrides orbit laps if greater than minimum threshold) |
| Orbit pattern center offset | Offset vector of orbit pattern center from known target location |

Synthetic Vision Displays

Geneva's industry partner, SDS International, has emerged as a leader in high-fidelity PC based photo-realistic synthetic visualization technologies. ArchAngel Synthetic Vision Displays (SVD), one of SDS' SVD products provides revolutionary improvements to the efficiency and effectiveness of the war fighters by providing real-time displays of 2D and 3D images that include threats, friendlies, and command and control overlays. The visuals offer complete and current sensor/decision maker/shooter information, plus situation awareness for safety and navigation. ArchAngel utilizes synthetic vision plus simulation functionality assimilated from Distributed Mission Training (DMT), DIS and HLA Tools, and Constructive Simulations to support combat missions.

ArchAngel is aimed at providing innovative visualization technologies as an "Information Portal" based upon XML and Intelligent agents to provide "Pull" and "Push" to address a broad range of sensor-decision maker-shooter issues. ArchAngel's design focus is to provide relevant real-time portions of AWACS, JSTARS, Rivet-Joint and sensor data to the cockpit of the shooters including relaying of Satellite and UAV imagery.

Geneva Aerospace has an ongoing funded effort to adapt the ArchAngel technology to the VACS

UAV control station environment to include in-time and coordinated sensor/decision maker/shooter information that is HLA distributed from the VACS ground control station to the synthetic visual displays. The displays include threat data realistically displayed over mapped and photo-realistic 3D terrain. Damage Assessment prediction visuals are supported with fire, smoke and even wind blown smoke. The key innovations include the ArchAngel project features of real-time multi-source fusion and display via Super-MFD and SDS's Fast-Panel technology.

The following figure illustrates examples of the visualization technologies, including "pathway in the sky" visual overlays and visualization enhancements gained from overlaying / fusing synthetic terrain with ortho-rectified, geo-registered imagery.

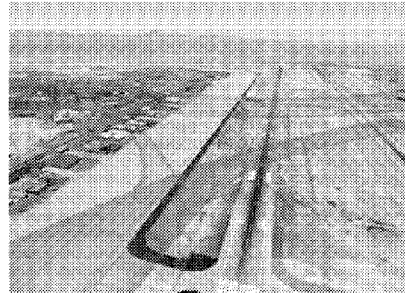

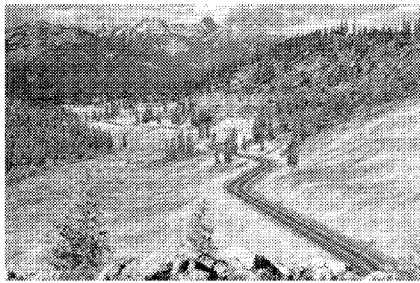
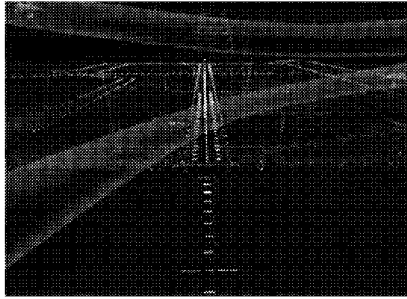

Figure 3 Photo-Realistic Synthetic Visualization Illustrations

The Synthetic Visuals are driven by the UAV in a manner very similar to the original design intent of a high fidelity flight simulator commanding own ship eye-point, environment and other entities. The main difference being that instead of a high fidelity flight simulator, live UAV state information drives the own ship eye-point. Furthermore, the other entities (ground-based threats, other aircraft, etc.) can be real-world sensed entities as opposed to simulated entities.

The photo-realistic, geo-specific visuals that were originally developed for training and

mission rehearsal are now directly usable in operational UAV contexts. In the simplest terms the GPS and INS data that report UAV position are utilized as inputs to the Synthetic Visual Display's API, which couples the state data with FOV and orientation information from the cameras and sensors onboard the UAV. Replication of the simulated visuals provides "perfect weather", daylight visuals regardless of the night, weather, fog, clouds, or camera/sensor battle damage. The use of wider FOV, multiple screens, augmented symbology and network integrated data exchange support an entire new generation of situation awareness enhancements, tools and operator decision aids, especially in the context of UAVs with flexible ground control stations and network interconnectivity.

The Synthetic Vision Display (SVD) technical approach is based upon integrating advanced simulated visuals originally developed for training purposes, into UAV operational systems. Specifically, the successful integration of SDS's Simulated Visuals with the Geneva VACS Ground Control Station (GCS) during recent AFRL sponsored flight testing at the Army's 10th Mountain Division training range at Ft. Drum, NY is indicative of the potential advances that merging these technologies can have in the near-term. Further, simulated HUDs developed for other training simulations have direct utility in the Synthetic Visuals. A high level description of the technical approach encompasses SDS International's Acuity Visual

Products to provide the basic synthetic visuals and some of the simulated HUD features. Additional "Super-HUD" functions, features and symbologies are being leveraged from AFRL/SDS's UCAV DMT Testbed effort, the Space Maneuver Vehicle Prototype, ArchAngel Prototype and AFRL VR-HMD R&D efforts. SDS's considerable experience with DIS and HLA has also lead to innovations utilizing the Dead Reckoning Algorithm's (DRAs) to reduce the frequency of communication updates required in the UAV operational context.

Multi-UAV Control using VACS

Key technology areas that have been employed to support the VACS multi-vehicle control research, development, and flight-testing include communications, controls, vehicle management, human factors, and simulations. The VACS design implements spread-spectrum communications hardware architectures and supporting multi-layered communications software packages that enable multi-vehicle messaging. Furthermore, we have conducted extensive work in multi-vehicle simulation development – both in the area of pure simulation based, network centric multi-vehicle analysis with Geneva's industry partner SDS International as well as in the more pertinent area of real-time system multi-vehicle simulation, including Processor-in-the-Loop (PIL) and Hardware-in-the-Loop (HIL)

simulation. The fundamental difference between the two simulation approaches is that the former approach placed less emphasis on real-world implementation concerns and focused on higher-level concept development whereas the latter is designed entirely around real systems and considers all pertinent real-world implementation concerns. The simulations from the latter approach drive our real-time, flight-worthy systems and, therefore, consider all of the limiting factors associated with the communications and flight control systems hardware and operating environments.

The multi-vehicle simulation studies have followed two approaches: 1) the Distributed Mission Training (DIS/HLA network protocols) approach for trade study analysis and 2) real-time, multi-system simulation using Geneva's internally developed multi-layered communications packages across RS232, 115.2 kpbs, using wireless RF (via spread-spectrum datalinks) connectivity between systems. For simulation studies in a non-laboratory environment, approach (2) uses the same-layered communications software package as in the lab environment, however the lowest level of the communications layer uses the Ethernet as opposed to the serial Input/Output device.

Finally, as discussed previously in this paper, we have designed and implemented a novel, variable autonomy vehicle management and control architecture that facilitate multi-vehicle

control with varying levels of functional allocation between the operator and the UAV network. Human factors engineering and live flight-testing have played key roles in the evolution of the VACS design. This gradient control implementation supports the full spectrum of autonomy from manual to supervised, to autonomous. The core architecture is highly flexible and offers a proven, core architecture to support the full evolution of the cooperative control solution.

Included in the VACS core are a set of mission health assessments generated based on much faster-than-real-time simulations that monitor vehicle performance utilizing UAV sensor inputs. Also included in the VACS core is an automated DTED based ground collision avoidance system. These capabilities play an important role, from the human factors perspective, in the multi-vehicle control problem as they offer automated system health monitoring and fault mitigation capabilities that significantly reduce operator workloads associated with managing a network of cooperative and non-cooperative UAVs.

As previously discussed, inherent in our efforts is the design and implementation of novel situation awareness technologies that facilitate effective management and control of multiple UAVs by a single operator. The VACS approach features mixed reality concepts using photo-realistic 3D synthetic vision displays

driven with both sensed and simulated vehicle state information.

Additionally, the work in variable autonomy controls has extended to the areas of automated collision avoidance technologies, where Geneva Aerospace has secured an ONR sponsored Autonomous Operations program to integrate VACS software with multi-vehicle sensing technologies to provide an optical sensor based automated air collision avoidance capability for UAVs. As evidenced by the research so far, the multi-vehicle cooperative behavior and control problem is dependent on both control system and situation awareness technologies.

VACS GCS Software

The VACS human-system interface (HSI) is a graphical user interface (GUI) that allows the operator to quickly alter the UAV course with little effort. The VACS HSI focuses on the UAV mission tasking rather than vehicle aviation; hence, the VACS interface places minimal significance on standard "cockpit" displays and focuses on situation displays. The operator interacts with VACS through the use of a mouse, a joystick (or game pad), and a keyboard. The software can easily be modified to take advantage of the touch-screen capabilities of the rugged notebook computer.

Push buttons in the main GUI provide access to dialogs that provide vehicle status information, sensor management and control functionality, and information dissemination capability through both data logging and network connectivity. A route editing dialog is accessed from the map display and provides the operator rapid, intuitive point-n-click system interaction for real-time mission planning and route editing capability, as well as map display editing features (zoom, center, change map background, etc). The route editing pop-up dialog provides the operator the capability to either type in known, precise waypoint coordinates or record graphically edited route event coordinates and parameters. The situation (map) display also contains a target editor with the capability to tie targets to UAV mission objectives and a corridor editor set no-fly zones and/or other mission planning boundary constraints.

Currently, the mission / route editing is performed manually by the operator, using the graphical user interface "point-n-click" functionality on the map or "fat-fingering" the coordinates. The interface, however, was designed generically so automated route plans can be accepted. VACS contains automatic route/mission analysis tools to alert the operator if a planned mission is not physically realizable due to vehicle performance constraints or terrain collision issues. Geneva Aerospace is planning efforts with various VACS customers to automate the entire in-flight route planning

process by integrating the Air Force's In-Flight Planning modules (3) with the VACS ground control station.

The VACS GCS also contains a Cautions, Alerts, and Warnings (CAWS) panel that alerts the operator to system malfunctions, low fuel, route errors, and various other off-nominal conditions. The CAWS display will alert the operator when a vehicle subsystem fault is detected.

Using the VACS GUI interface, the operator can maintain any level of control over the UAV, from fully manual to fully autonomous, with the simple click of a mouse.

A feature in the VACS GCS GUI is the incorporation of the Digital Terrain Elevation Database (DTED) with the map display and route planning tools. The VACS software includes a module that performs real-time interpolation on the DTED and provides terrain elevation at the vehicle's current geodetic location, along with a terrain elevation projection 5 km along the vehicle's current heading. Additionally, the DTED routine provides a real-time display of the operator's input device pointer location (such as the mouse cursor) over the map to provide rapid feedback of terrain elevation at selected geodetic locations. This DTED feature is used to aid in preflight and real time mission planning.

The DTED capability is currently being extended to the VACS airborne digital flight control system to provide a DTED-based automatic ground collision avoidance system (AutoGCAS) for both cruise missile and UAV applications. This AutoGCAS capability will be flight test demonstrated on the Dakota UAV testbed in late summer 2002.

The VACS design offers enormous flexibility to the UAV operator and reduces the operator workload to a level that facilitates the control of multiple UAVs by a single operator. The synergistic combination of the VACS design, the In-Flight Planning system, and the Synthetic Vision Display provide a comprehensive multi-mission, multi-vehicle automated UAV mission management and control system.

VACS TESTING

Testing of VACS has consisted of hundreds of thousands of all digital Monte Carlo simulation cycles, hundreds of hardware in-the-loop (HIL) simulations, over a dozen developmental test flights on two different UAV platforms, and one operational scenario demonstration flight at the Army's 10th Mountain Division training range at Ft. Drum, NY.

The live flight exercises have demonstrated that a single operator with no aviation skills can simultaneously manage and control the UAV

and the UAV primary sensor. In these demonstrations, the operator was able to effectively transition control levels, update mission plans, monitor the UAV imagery, monitor the UAV systems status, and trouble shoot system malfunctions from the ground control station while the UAV demonstrated seamless mode transitions and at all times behaved as the operator expected and required. Furthermore, we demonstrated both in simulation and in flight exercises that the design eliminates common pilot induced faults such as pilot induced oscillation, stall, spin, over-g, or other pilot induced phenomena that over-drive the airframe and result in the loss of the vehicle.

During the Phase II effort, Geneva Aerospace teamed with Northrop Grumman Corporation to integrate the Variable Autonomy Control System ground control station with the Joint STARS Moving Target Exploitation (MTE) workstation to demonstrate the effectiveness of the VACS human-system interface and VACS UAV control approach in a real-world, airborne battle management system. The VACS control station proved to offer an effective, intuitive human interface for the Joint STARS operator. This capability was successfully demonstrated in a scenario representative of that of Figure 4, with the Joint STARS participation being simulated by a ground operator utilizing a modified Joint STARS MTE workstation. The next round of demonstration flights is scheduled for the late summer 2002 tests, and will

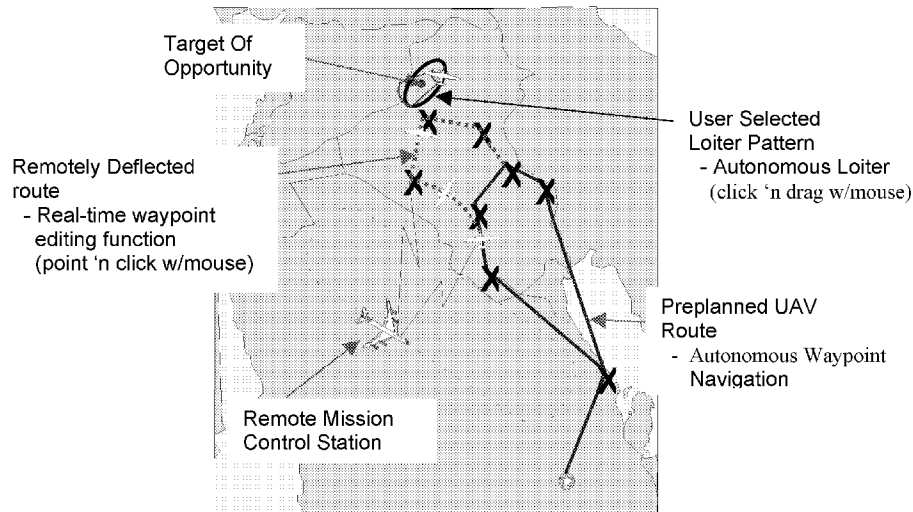

Figure 4 Wide Area Surveillance Sample Mission

showcase the multi-vehicle control, ground collision avoidance, and auto take-off and auto land capabilities.

Conclusions

The Variable Autonomy control System (VACS) is a comprehensive, flight proven air vehicle multi-modal management and control architecture designed to support the emerging generation of autonomous and semi-autonomous UAV systems. The synergistic combination of advanced, gradient control concepts, intuitive human-system interfaces, and photo-realistic synthetic vision displays offers a comprehensive, off-the-shelf multi-UAV management and control package and provides a core flight control architecture that will enable

the rapid transition of autonomous UAV technologies to the war fighting community.

References

1. Duggan, David S., "Demonstration of an Integrated Variable Autonomy UAV Flight Control System", Phase II SBIR Final Report, AFRL-HE-WP-TR-2001-0035, January 2001
2. Swihart, Donald E., et al, "Joint Development of an Auto Ground Collision Avoidance System", 4th Saint Petersburg International Conference on Integrated Navigation Systems, May 1997
3. Leavitt, Charles A., "Real-Time In-Flight Planning", May 1996, USAF Contracts F33615-92-C-3805 and F33615-94-C-1431

1
2
3
4

Exhibit 9 - From Geneva Aerospace Provisional Application 60/480,192
Small Business Innovation Research (SBIR) Program Projects
Summary, Topic Number AF98-179

APPENDIX B

U.S. DEPARTMENT OF DEFENSE
SMALL BUSINESS INNOVATION RESEARCH (SBIR) PROGRAM
PROJECT SUMMARY

TOPIC NUMBER: AF98-179

PROPOSAL TITLE: **Examination of an Integrated Autopilot Design for Simplified UAV Flight Control**

FIRM NAME: Geneva Aerospace, Inc.

PHASE I or II PROPOSAL: Phase I

Technical Abstract

In order to be truly versatile, Unmanned Aerial Vehicle (UAV) Systems must be usable to individuals who's training is more focused on the requirements of a given mission or on the usability of the payload, rather than on the aviation of the air vehicle. This suggests that flight control systems must respond to higher level, more intuitive remote commands such as "go left", "go right", "climb", or "dive".

Modern embedded guidance and control processing methods such as those used for autonomously guided cruise missiles or advanced military aircraft demonstrate that low-level stick-and-rudder commands can be eliminated as a requirement on the remote operator. In addition to a more intuitive command-response autopilot, Geneva Aerospace has developed a design which allows the integration of intuitive "mission-level" remote commands into the guidance system, significantly reducing the work-load on the operator as it pertains to the aviation of the UAV.

The guidance system is evaluated on the Freewing Tilt-Body airframe, which provides unique inherent camera stabilization and "Extremely" Short Take-off and Landing properties. The integrated guidance design and systems engineering approach proposed provides a modular core structure that can easily be upgraded and can grow with increasing technology.

Anticipated Benefits/Potential Commercial Applications of the Research or Development.

A well integrated mixed-reality guidance system could Make UAV's useful for border patrol, speed control, hazardous area investigation, atmospheric sampling, or even motion picture filming by persons who could operate with minimal aviation expertise or manual skill.

Keywords:

Unmanned Aerial Vehicle
 Guidance/Autopilot
 Virtual Reality
 Telepresence

Mixed Reality
 Autonomous
 GPS Aided Navigation
 Ground Station

Nothing on this page is classified or proprietary information/data
 Proposal page No. 2

1.0 Identification and Significance of Opportunity

The nature of this research opportunity is best appreciated by first posing a set of top-level requirements for an "Ideal UAV System":

The system must be easy to use with minimal training. As recognized in the solicitation, an effective UAV system will respond to more intuitive command motions. This will allow the operator to focus on the payload and mission operations rather than on aircraft piloting. Commercialized products such as video games and CAD utilities provide an excellent model for human interfaces which have already been evaluated and tested on the open market. In fact, the ideal simplified UAV autopilot should be compatible with COTS hardware such as standard joysticks, track-balls, lap-top computers, and Virtual Reality Head Mounted Displays and Glove Input Devices.

The system must be able to operate autonomously as well as respond to high-level remote commands. Autonomous mission capability with the ability to remotely interrupt the mission is essential to minimize the work load of the operator when flying multiple-UAV's from a single ground control station. The ideal guidance concept will nominally operate with enough autonomy even when responding to remote commands that one person will be able to operate several UAV's from the same station.

The system must be adaptable to on-going command-and-control software development efforts. For military applications, the system will be required to operate within the advanced Command, Control, Communications, Computers, and Intelligence (C4I) infrastructure and interface with associated Common Ground Control Stations such as the Joint STARS Common Ground Station. As a commercial application, this could be a lap-top version of a somewhat less complicated, but similar ground control package. The guidance software must have the capability not only to respond to the command interface, but must also be capable of expanding modularly as new capabilities are desired without significant changes in the interface.

Advances in Virtual Reality simulation graphics display technology makes the concept of a Virtual Reality interface to real-time systems feasible. Already used by surgeons in the Medical community, the use of Virtual Reality, such as Telepresence or Mixed Reality systems, in UAVs is not far away. For this reason, we include an evaluation of a Line-of-Sight Slave mode capability in which the operator's point of reference is the image scene transmitted from the UAV's on-board camera (we will refer to this as the "tactical situation display"). In this mode the operator does not provide direct directional commands to the UAV. Instead, the operator focuses his attention on the tactical situation display, commanding the look angle of the UAV's on-board sensor to survey the battlefield (or other topographical region for non-military applications) while the UAV autonomously commands a flight profile which is slaved to the operator's sensor line-of-sight commands. As discussed below, our integrated guidance solution adapts easily to this mode.

The system must be easy to land. Even with directional-response controls, the operator must be capable of commanding the flare and touch-down phase of landing. To

eliminate this operator requirement, the simplified autopilot must be compatible with existing COTS automatic landing systems such as the Sierra Nevada Corporation's UAV Common Automatic Recovery System (UCARS), and hence must be able to land autonomously under nominal conditions. The system must also be able to respond to changes in the terminal approach when the operator detects an obstruction or desires a change in the landing conditions. In addition to its other benefits, the ESTOL capability of the Freewing Tilt-Body airframe design simplifies and reduces the risk of vehicle recovery over that of conventional fixed-wing UAVs

The system will be highly modular, and manufactured from Commercial, Off-the-Shelf (COTS) components. To compete as a marketable product, the system must be affordable, maintainable, and easy to upgrade. For the system to be flexible enough to do so, the guidance software must be designed to work under varying configurations with changing levels of uncertainty. For this reason, a robust, integrated control system design approach will be evaluated.

The above requirements point toward on-going Freewing Tilt-Body UAV development efforts by Freewing Aerial Robotics Corporation and Geneva Aerospace. The proposed SBIR study effort presents an opportunity to evaluate this system against the above desired capabilities, leading to a rapid development and marketing of the "Ideal UAV".

The Geneva guidance concept is founded in the understanding that a UAV can be controlled more like a missile than an airplane because human comfort is not a constraint. We can use a more flexible multivariable controller structure and can allow the airframe to perform conventionally unacceptable maneuvers such as negative accelerations, skidding turns, and high body-rate stabilization. Our controller structure integrates the guidance and autopilot sub-functions (outer loop path commands and inner loop stabilization). As we will show later in this proposal, the simplified autopilot concept is a straightforward augmentation of our integrated guidance design approach.

We have chosen the surveillance mission as a platform for evaluation because of its apparent commercial application potential. A well integrated mixed-reality guidance system could Make UAV's useful for border patrol, speed control, hazardous area investigation, atmospheric sampling, or even motion picture filming by persons who could operate with minimal aviation expertise or manual skill.

2.0 Feasibility of Technical Approach

The proposed technical design approach to the simplified autopilot and integrated surveillance system is made feasible by both the maturity and unique aerodynamic features of the host UAV platform, the Freewing Scorpion Model 100-50, and the maturity of the Geneva all-digital Six-Degree-of-Freedom (6DOF) simulation and integrated guidance design solution. A key feature of the Freewing design concept is its inherent ability to automatically neutralize the effects of turbulence on the fuselage, providing a host sensor platform which requires a significantly less expensive gimbal stabilization system than conventional fixed-wing air vehicles.

Geneva Aerospace has independently developed an integrated guidance design solution using modern robust control systems design techniques. This multivariable integrated guidance design solution provides a low-risk systematic design approach for the simplified autopilot application. The integrated guidance design solution uses system model uncertainties in the vehicle controller design, providing a robust controller design over the model uncertainty region.

2.1 Simplified Autopilot Feasibility

The simplified autopilot provides a UAV control mechanism which allows the remote pilot to provide intuitive directional commands rather than conventional stick and rudder commands. These so-called intuitive commands can be paralleled to outer loop guidance commands in conventional missile flight control systems. Typically the outer guidance loop in these systems provides fairly low frequency acceleration and bank angle commands to a three-axis (pitch, yaw, and roll) autopilot. It is this autopilot which is responsible for generating the commands to the actuators and performing the higher frequency body rate stabilization, thereby resolving the body accelerations and bank angle to the desired commands in a stable manner and tracking the desired trajectory. Such control systems have been in existence for decades and have been proven both in the test environment as well as on the battle-field. In recent years, the advancement of embedded controller technology (e.g., embedded microprocessors) has driven the industry standard to the use of digital autopilots. High performance microprocessors such as Intel's Pentium processors or Texas Instruments' C40 chips can be procured at relatively low cost, making the use of a fairly high performance digital autopilots in UAV systems cost effective and, therefore, feasible.

Geneva has combined the technology associated with high performance missile and aircraft fly-by-wire autopilots with the application of a remote piloted UAV to develop an integrated design solution which satisfies the need for a simplified UAV autopilot system. Utilizing a robust multivariable control system design approach, we have developed a *single* control structure for a UAV autopilot which is robust and modular in nature, allowing multiple levels of remote pilot control as well as fully autonomous flight. We believe that the proven digital autopilot technology in modern weapon systems and high performance aircraft combined with readily available commercial off-the-shelf (COTS) microprocessors and integrated GPS inertial navigation kits makes our concept the right solution for the next generation UAV autopilot.

2.2 Freewing UAV Description

The Freewing Scorpion Model 100-50 has been privately developed by Freewing and represents the culmination of nearly fourteen years of design evolution. The fairly recent formulation of diverse military UAV mission needs has created the venue for which this technology is most attractive. The first UAV variant of the Freewing design flew in 1992, manned variants having flown as early as 1983. The Scorpion evolved through 40% and 50% scale models developed by Freewing with Burt Rutan in 1992 and 1993, respectively. The design featured the freely hinged wing and vectored thrust gained simply by independently rotating the forward fuselage upward relative to the tail boom assembly. The Scorpion 100, also developed with Rutan, first flew in 1994. The Scorpion 100 capabilities include

conventional vehicle-like dash and cruise performance, an extremely short takeoff/landing capability, and turbulence mitigation characteristics. Additionally the vehicle is inherently stable and relatively insensitive to large center-of-gravity changes, making it an appealing platform for a variety of COTS sensors.

The Freewing Scorpion 100-50 provides extremely short takeoff and landing (ESTOL) performance in a simple, modular vehicle that provides a stable sensor platform while retaining all the advantages of a conventional fixed wing aircraft. The freewing tilt-body is a new kind of aircraft, distinct from fixed wings and rotary wings. It is a combination of two tested technologies, the improved free-wing and the tilt-body, which combine to provide an extremely short takeoff and landing aircraft that is stable throughout its flight envelope, while requiring only a few moving parts.

In the Freewing aircraft, the wing is placed on bearings so that it is completely free to rotate in pitch, de-coupling the wing in pitch from the fuselage. Trim surfaces on the trailing edge of the wing are used to control the wing angle of attack and to provide roll control. The resulting "flying wing" has a fraction of the effective pitching moment of inertia compared to an otherwise identical fixed wing vehicle. This allows the wing to rapidly and automatically adjust the angle of attack (as would a weathervane) in response to gusts and other changes in the relative wind. Traditional fixed wing aircraft must overcome the moment of inertia of the entire aircraft to accomplish the same change. But the rapid pitch response of the Freewing allows it to effectively maintain a constant angle of attack with respect to instantaneous wind direction for a given trim surface setting. In addition, the absence of a root moment means that only very small variations in the magnitude/direction of aerodynamic forces are transmitted to the fuselage. The result is a smoother, more stable flight and better sensor resolution since air turbulence is largely neutralized before being transmitted to the fuselage. NASA studies show that accelerations due to gusts are reduced by as much as an order of magnitude in a Freewing aircraft compared to a similar fixed wing aircraft. Conservative estimates developed for the Scorpion by Texas A&M show a 50% reduction in gust loading over the low frequency end of the wind spectrum.

With the Freewing Tilt-body vehicle, the de-coupling between fuselage and wing is taken a step further. Here, fuselage trim surfaces generate body pitching moments independent of the wings, effectively de-coupling the thrust vector from the aircraft velocity vector. The fuselage itself is a lifting body, so the result is a left/right wing pair joined by a rotating spar passing through the lifting body. Both the left/right wing pair and the central lifting body are free to rotate about the span-wise shaft.

The Scorpion tilt-body aircraft has all the attributes of the Freewing Tilt-Body class. The Scorpion 100-50 was designed by Burt Rutan and Scaled Composites, in collaboration with Freewing Aerial Robotics, to meet the original Joint Tactical UAV requirements. The Scorpion was designed to make maximum use of commercial off-the-shelf (COTS) equipment to reduce costs and ensure availability of spares. The following figure shows a side view of the Scorpion in both a take-off/land and cruise configuration. This figure also shows a planform view of the vehicle.

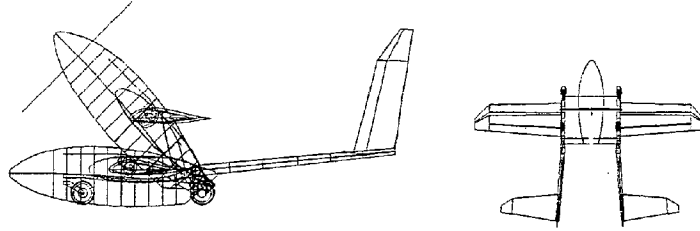

Figure 1: Freewing Side-View and Planform

The following table provides the main physical characteristics of the Scorpion 100-50.

Table 1: Scorpion 100-50 Air Vehicle Physical Properties

| | |
|-------------------------------|--------------------------|
| Total length | 11.8 ft |
| Span | 16.1 ft |
| Wing area (total) | 37.3 sq ft |
| Freewing area | 61% sq ft |
| Stub wing area | 39% sq ft |
| Total height (cruise mode) | 4.1 ft |
| Total height (tilt body mode) | 6.75 ft |
| Maximum take-off weight | 444 lbs |
| Empty weight | 322 lbs |
| Maximum payload weight | 50 lbs |
| Maximum fuel load | 72 lbs |
| Power | 52 hp |
| Max RPM | 7000 (3000 output shaft) |
| BSCF | .52 - .57 lbs/hp-hr |
| Propeller | 60" fixed pitch |
| Direction of rotation | CW (facing propeller) |
| Static thrust | 270 lbs |

2.2.1 Freewing UAV Capability

The following figures show the Scorpion Model 100-50 climb rate, flight envelope, range efficiency, and loiter efficiency. The predicted rate of climb as a function of airspeed and altitude is given in Figure 2, indicating a service ceiling of about 13 kft and a best climb speed of 60 to 70 knots. The resulting times to climb at full power are 5.0, 11.9 and 17.3 minutes to

5K, 10K and 12K feet, respectively. The maximum level flight envelope and service ceiling are shown on Figure 3. Since the vehicle's wing does not stall, the minimum speed will be determined by control limitations and maximum thrust. The indicated limitation at low speed is based on present flight test experience.

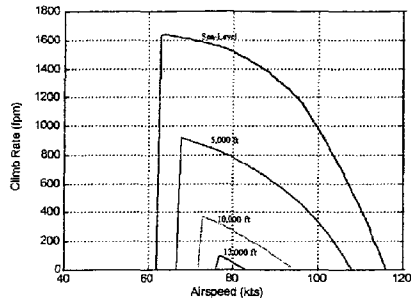

Figure 2: Rate-of-Climb

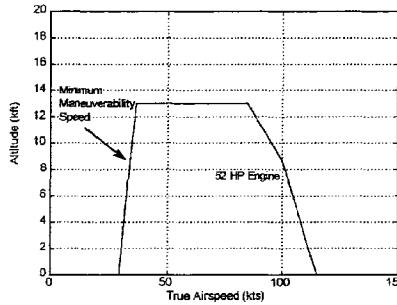

Figure 3: Flight Envelope

The range factor for this engine at sea-level is about 7 nm/lb at 65 knots. The endurance factor is predicted to be 6.8 min/lb. Data for this engine at altitude will not be available until the completion of the flight test program. We have therefore used the sea-level fuel consumption figures for range and endurance calculations for all altitudes.

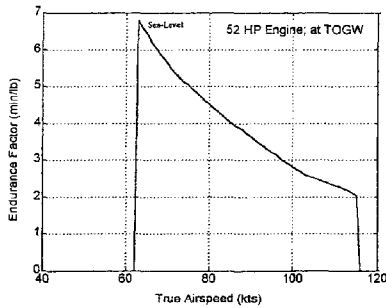

Figure 4: Endurance Factor

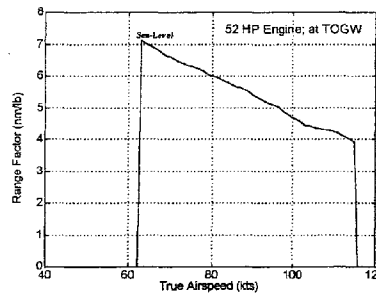

Figure 5: Range Factor

With a maximum fuel load of 72 lbs and an endurance factor of approximately 6.8 min/lb, it is evident that the Scorpion vehicle is capable of providing several hours of time on station. The Scorpion loiter efficiency combined with its inherent insensitivity to turbulence makes this vehicle an attractive platform for the development and test of the simplified UAV autopilot concept.

3.0 Phase I Technical Approach

We view the research opportunity for this effort to be two-fold. The Geneva integrated guidance design approach merges the seeker, GPS/Navigator, guidance/autopilot, and remote command sub-functions in a structure that will greatly reduce workload and training requirements for the operator. In addition to the functionality of this design, we will assess a systems engineering design approach which will result in a lower-cost, more produceable, and more maintainable UAV. We therefore additionally propose to gather data which will show a cost benefit to our improved integrated systems engineering process.

3.1 Control System Architecture

Our controller design approach introduces several high-level operational modes, with varied levels of automation:

Energy-Optimization: Autonomous flight with only a single observation point and time-on-station requirement. The guidance determines speed, altitudes and flight paths to minimize energy expenditure.

Pre-Planned Waypoint: The vehicle flies the pre-programmed waypoints, either specifying speed and altitude, or allowing the UAV to autonomously determine them from the energy management system.

Real-Time Waypoint Editing: Can be entered at any time during a mission by specifying a waypoint that the UAV can physically reach from its current location, or by changing the location of an existing waypoint.

Directional Response Autopilot: Entered automatically by moving the joystick. The joystick commands immediately override the existing commands and relate to changes in flight path.

Line-of-Sight Slave: The vehicle heading is commanded to align with the camera line-of-sight commands until the vehicle comes within a specified radius, in which case it is commanded to circle the designated point.

These operational modes suggest an hierarchical control structure with varied levels of remote pilot command insertion. For example, when flying in the "stick and rudder" mode, the pilot commands would be inserted at the lowest control level immediately prior to actuation. Conversely when flying the directional-response autopilot, the commands will be inserted as vertical or horizontal flight path turning rates. LOS Slave commands would be inserted at the guidance command level. Figure 6 shows the proposed control loop organization structure:

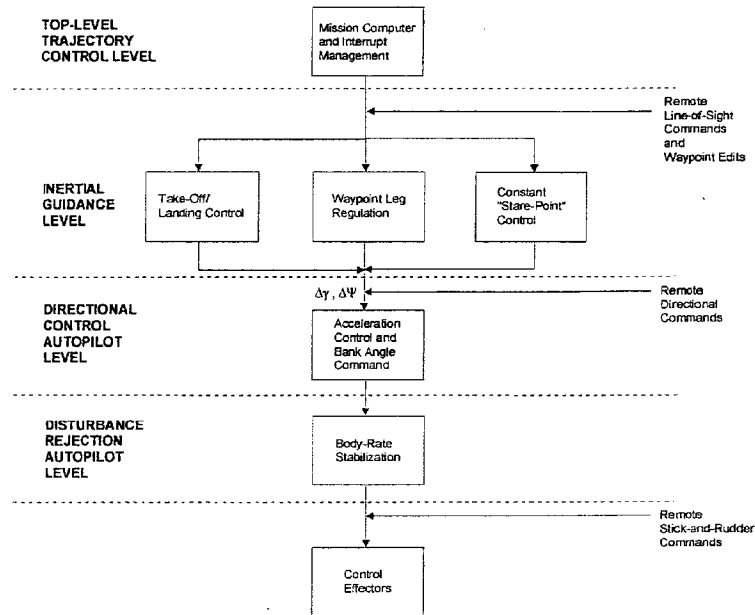

Figure 6 Airframe Control Structure Organization

Perturbations in flight path and ground track angles ($\Delta\gamma$ and $\Delta\Psi$) provide the command signals used for outer loop guidance because they can be mapped directly to “go up/go down” and “go left/go right” intuitive commands and because they lend themselves well to the inertial control laws which are used for the autonomous guidance modes. Figure 6 shows several parallel processing paths at the guidance level. Processing for the outer-loop control is determined by the top-level trajectory control, which is driven primarily by the remote pilot’s mode selection and by inertial trajectory requirements. This controller structure leads to a more modular software architecture, which will be useful for future capabilities or use on other UAV systems.

By mapping joystick motion into $\Delta\gamma$ and $\Delta\Psi$, we can achieve the added benefit that letting go of the joystick (referred to here as “stick-free”) will result in constant velocity, straight-and-level flight. This will be valuable to the operator when he/she needs to change to another task such as camera slewing or waypoint editing without having to switch to a completely autonomous autopilot mode.

The primary modes for use, and therefore the focus of the evaluation efforts will be on the directional-response autopilot, the LOS slave mode guidance, and the waypoint editing capability. The following discussion defines the operational concept for each of these modes.

Directional-Response Autopilot. The purpose of directional command response is to enable an untrained operator to maneuver the vehicle in a stable manner as he or she affects

the trajectory from ground-station information without having to compensate the faster loop dynamics of rate stabilization, aerodynamic coupling, or speed control. This can be achieved by associating changes in flight-path with the joystick motion, and by injecting these commands into a multi-variable digital autopilot which autonomously controls engine throttle, thrust vector setting, and body rate stabilization. Figure 7 shows the proposed multi-variable control loop structure, augmented with the higher-level functions.

When operating in directional response mode, the joystick commands are converted to flight-path angle change commands through a scheduled gain. This gain must be scheduled versus thrust setting and body tilt angle to maintain equivalent command-per-joystick deflection slope.

The operator will have command of speed control via a simplified, constant setting on his/her display. The directional commands and velocity setting comprise the command vector entering the autopilot. It should be pointed out that the other operational modes also provide the same command signals after some level of processing.

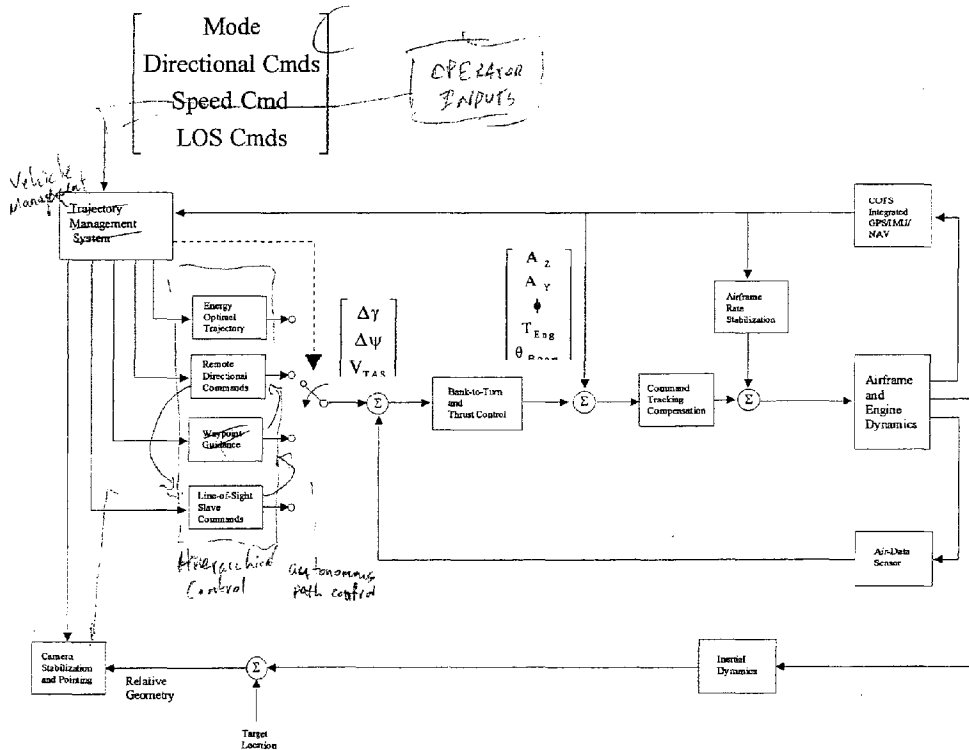

Figure 7 Multivariable Control Loop Structure

The Tilt-Body provides a unique thrust-vectoring capability which is optimally utilized in the thrust vector controller. Figure 8 shows that there are several trim points for most operating conditions across the locus of boom angles and elevator deflections. The data depicted in this figure represent the sum of the aerodynamic force coefficients and installed thrust coefficients at a 50% throttle setting.

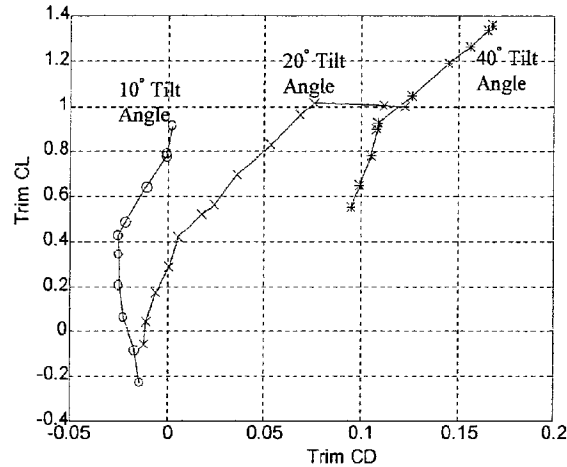

Figure 8: Trimmed Lift vs Drag

The above figure shows both the benefits and penalties associated with the thrust vector. For example, note that when the body tilt is increased from 10 to 40 deg, the total maximum lift capability at 50% power increases by 50%. Also note, however, the severe drag penalty associated with the high boom angle configuration. Consequently, these trim solutions are scheduled as functions of energy management constraints, maneuverability requirements, and desired speed. The curves are synthesized into an integrated multi-variable boom angle and throttle control, which are driven by the operator's speed and mode settings as command inputs. The low speeds available from the Tilt-Body will be a benefit for surveillance purposes, but can result in aerodynamic stall on the tail surfaces. This is particularly a concern when flying at higher boom angles, where the vehicle must fly at slow speeds in order to maintain speed trim. For this reason, the stall limits are multi-dimensional in nature and include a predictive stall-avoidance algorithm.

Because the operator may be inexperienced or otherwise occupied, the system includes control deflection and command limits at several levels to prevent non-linear aerodynamics such as stall and cross-channel coupling, over-expenditure of any mixed control surface in a single axis, structural over-loading, or actuator slew rate limiting.

LOS-Slave Control

The directional-response autopilot, combined with the stabilized seeker platform allows a single minimally trained operator to easily conduct a UAV surveillance mission. A further level of user simplification is achieved by combining seeker designation command logic with the outer

loop guidance. This mixing provides Line-of-Sight Slave mode capability in which the operator's point of reference is the image scene transmitted from the UAV's on-board camera. In this mode the operator does not provide direct directional commands to the UAV. Instead, the operator focuses his attention on the tactical situation display, commanding the look angle of the UAV's on-board sensor to survey the battlefield (or other topographical region for non-military applications) while the UAV autonomously commands a flight profile which is slaved to the operator's sensor line-of-sight commands. This integration of the camera platform with the guidance provides the following benefits:

1. Time-on-station loiter control which can be easily selected and designated.
2. Further reduction of workload on the operator, who can now focus primarily on the surveillance aspects the mission.
3. An easily adaptable relative Navigation method.

Figure 9 shows an example of how LOS-slave control would be used with the ground station display. The Navigation display would be a top-view with a schematic of the aircraft for easier conceptualization. This symbology would be added to the set of flight state information normally found on the display. The outer circle around the aircraft is a projection of the entire seeker field-of-view onto the ground. The smaller pie-shaped queue is a ground projection of the current seeker borsight position. These would be calculated by the ground station software from the positional information and seeker angle sent across the data-link.

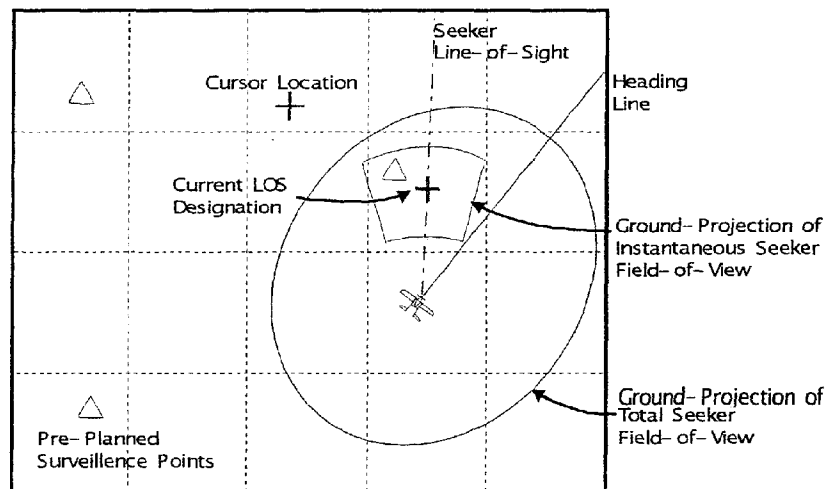

Figure 9 Augmentation to Tactical Situation Display

The remote pilot can opt to either keep the cursor active as the continual steering point, or he/she can designate a "surveillance-point" by clicking on a desired ground location. In the latter case, the staring point would be captured so the cursor could be moved to a new constant location.

If the pilot chooses a surveillance location outside the total FOV, then the outer loop guidance will follow a command-to-LOS mode guide law until the UAV flight path points toward the target. Once the desired staring-point comes within a minimum range threshold, the guidance automatically trips into a loiter pattern (either constant-radius or elliptical) to maintain track on the desired location. This guidance structure allows the operator to park the vehicle at a station with a single key-click while he/she conducts other activities. Figure 10 shows a diagram of the surveillance-point approach scenario.

If a constant location is selected within the minimum turning radius, then the guidance must fly over the surveillance-point and plan an out-and-back pattern to avoid a singularity in the loiter guide-law. This can be easily achieved by inserting waypoint legs autonomously.

If the operator chooses, he/she can select a standoff range (or accept the default range) for surveillance over a hostile target. The seeker line-of-sight commands will also comprehend the offset location to track on the desired location. This is achieved by inserting the offset range vector in the positional component of the loiter guide-law.

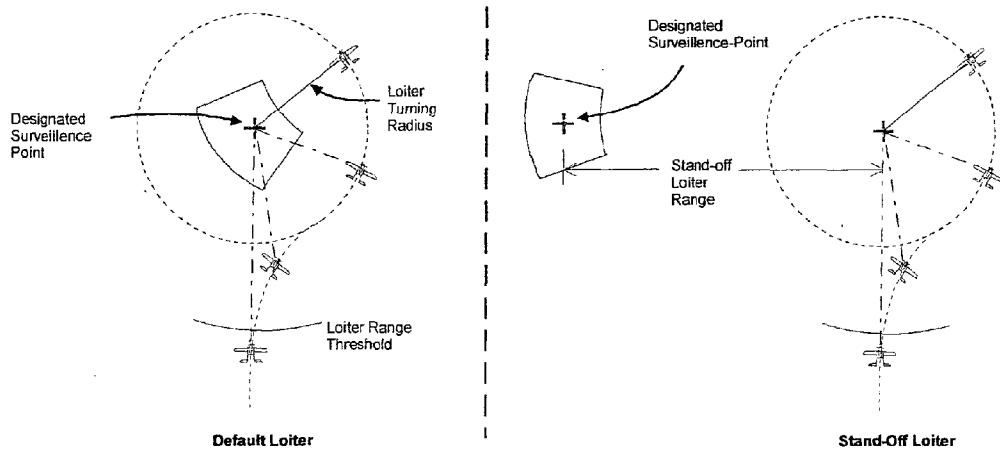

Figure 10 Surveillance-Point Approach Trajectory

The following simplified equations are used to show the basic structure of the LOS Slave mode guidance:

If ($R_{Target} > Loiter_Threshold$) then

$$\dot{\psi}_{Cmd} = K_{\psi} (\lambda_{Horiz} - \psi_{Heading})$$

$$\dot{\gamma}_{Cmd} = K_H (H_{CMD} - H) + K_H \dot{H} + \frac{g}{V}$$

else

$$\dot{\psi}_{Cmd} = K_{\psi} \Delta\psi + K_{\rho} \left(\rho_{Turn} - \left\| \bar{R}_{Target} + \bar{R}_{S \tan \epsilon - Off} \right\| \right)$$

$$\dot{\gamma}_{Cmd} = K_H (H_{CMD} - H) + K_H \dot{H} + \frac{g}{V}$$

endif

where

R_{Target} = Horizontal Range - to - Target

$\dot{\psi}_{Cmd}$ = Horizontal Turning Rate Command

$\Delta\psi$ = Heading Error Relative to Loiter Path

λ_{Horiz} = Horizontal Line - of - Sight to Target

$\dot{\gamma}_{Cmd}$ = Vertical Turning Rate Command

$\psi_{Heading}$ = Heading Angle

ρ_{Turn} = Loiter Turning Radius

H = Altitude

g = Gravity Acceleration Magnitude

V = Vehicle Inertial Velocity Magnitude

The above equations show two active horizontal guidance terms when flying the constant turning radius circle. The first term is the damping term which drives the vehicle to align its ground track with the desired circular loiter pattern and is the dominating term. The second term is a positional term to help maintain the constant arc.

Waypoint Mode with Real-Time Waypoint Editing

The waypoint guidance system is organized as a linked list of waypoints augmented with smooth turn and leg propagation logic at each station. This provides the capability to easily edit the waypoint list from the graphical display both during pre-flight mission planning and while the UAV is in the air.

The operator will now have the ability to insert waypoints visually with a track-ball or mouse. If the operator discovers an unknown hazard in the pre-planned flight-path, then he can either "drag-and-drop" the existing waypoints or he can delete and insert new waypoints as necessary.

By grabbing the joystick, the operator automatically overrides the waypoint mode and enters directional response mode. Waypoint mode can be re-entered by commanding the vehicle back to alignment with the current waypoint leg.

Autonomous and Directional Response Landing

The usability of typical UAV systems is strongly dependent upon how much skill and instrumentation is required at landing. Completely autonomous landings with conventional fixed-wing UAV's are only possible with very accurate terminal altitude instrumentation such as a millimeter-wave capture and recovery systems, differential GPS Navigation, or RADAR altimeters.

Most systems rely upon remote piloting at the terminal phase. Landing would present a challenge to the simplification of the remote pilot commands because of the complexity and timing of the terminal flare maneuver. However, the Tilt-Body design provides a solution to both autonomous and simplified-remote command landings. When the vehicle flies at high body tilt angle, a large component of lift is afforded at very low airspeeds. This makes it possible to fly the vehicle at steady-state terminal sink rates which will not harm the structure of the vehicle at impact. With this feature, the pilot needs only to command a landing point, and the vehicle guidance responds by setting up its own terminal leg geometrically. A weight-on-wheels sensor is added to shut off the motor at impact and to command negative lift on the Freewing.

The operator can correct the terminal flight-path if he visually detects an obstruction, or he can land the vehicle purely with the directional response autopilot. In this case, the internal command limits prevent him from slamming the vehicle into the ground with too much vertical velocity.

3.2 Typical Mission Profile

The utility of the modes discussed above are demonstrated with a example of how they might be used for a surveillance scenario. The sequence of events correspond to the diagram in figure 11:

- (1) After take-off, the operator points the camera or seeker with the joystick as the UAV flies autonomously along either per-planned or real-time inserted wayopints.
- (2) Operator-controlled maneuver to avoid reported hazard along flight path. The mode is invoked automatically by grabbing the joystick.
- (3) By letting go of the joystick (and not yet designating to re-capture waypoint plan), the UAV flies straight-and-level while the operator scans the seeker
- (4) Operator designates a stand-off surveillance of one of the original mission objective points.
- (5) The operator edits the original waypoints to command a return-to-base, flying by the second mission objective point.
- (6) Operator evokes continuous LOS Slave control to examine third target.
- (7) Operator commands a loiter prior to approach in order to coordinate with other mission objectives or vehicles
- (8) Applies the terminal waypoint to establish the run-in heading.

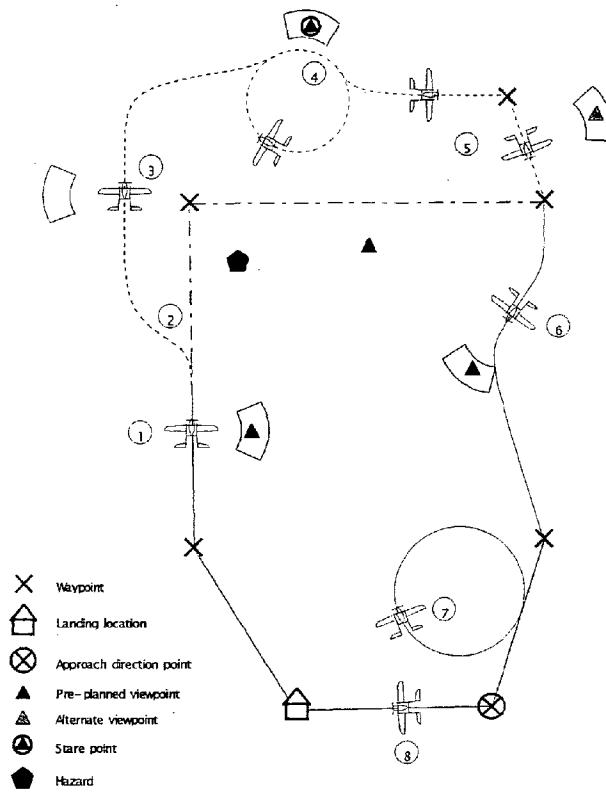

Figure 11: Sample Mission Profile

3.3 Systems Engineering Approach

The systems engineering process is modified to develop systems with COTS components by enabling us to evaluate the contributions of each subsystem to the top level requirements as well as the subsystem component interactions in the presence of a synthesized controller.

Rather than beginning with subsystem requirements from systems engineering trade studies, our process begins with cost and performance data from existing production-ready components. We will design modularity into the system by recognizing those de-facto interface standards which exist with the most cost-effective components. The guidance and autopilot compensation is then developed in parallel with the trade studies identifying the subsystems to be used. This allows us to trade-off certain characteristics of subsystems for equivalent top-level performance. For example, the degraded performance of a lower-cost IMU may be acceptable if slightly better actuators are available.

The cost/performance trades will be evaluated by observing their effects on the highest reasonable level of performance requirements. Several candidate systems will then be projected,

and their performance plotted versus cost. The most cost-effective system will then be identified, and the associated performance characteristics become the system specifications. If the resulting performance is less than what would be considered marketable, then the next higher performing candidate system will be chosen. Subsystem allocations will then be completed by recognizing the specifications of those already-procured components. This design approach has several benefits:

1. The development cycle-time and associated cost is greatly reduced by avoiding procurement on the subsystem level.
2. The design is modular by definition, thereby facilitating future subcomponent upgrades or system capability expansion.
3. The development cycle results in a low-cost, production-ready system design.
4. In this case, the system design can more effectively take advantage of the Freewing Tilt-Body's unique flying qualities.

3.4 Research Plan

We have introduced a guidance design concept and systems engineering approach that we believe can fulfill the list of requirements posed for a usable and versatile UAV system. Throughout phase II and into development, the final ground station and interface may take one of several possible forms. We feel our UAV guidance/autopilot structure will be compatible with existing C4I Common Ground Control Stations and will facilitate the advance of the UAV surveillance community into the realm of Virtual Reality, linking the senses of the operator with the sensors from the remote platform. We intend to show this by performing a simulation-based integration of the above guidance laws and relevant modeling parameters.

We will then perform a series of simulation trade studies and cost analyses to demonstrate the effectiveness of our integrated guidance design with the Freewing airframe. When complete, our results will either position us to begin phase II efforts or they will point toward other development tasks that should be pursued. The following work breakdown structure is proposed:

1.0 Industry survey of COTS performance parameters.

We will attempt to collect enough COTS subsystem cost and performance data to simulate at least 3 candidate integrated system designs. We will also collect the data necessary to model the subsystems.

✓ 2.0 Update 6DOF simulation to include subsystem models and interface.

In addition to subcomponent models, a set of prototype controller hardware must be integrated with the simulation. This will include a standard COTS joystick and mouse with appropriate driver software. This will not include a prototype of the ground controller interface.

✓ 3.0 Integrate the directional-response controller into simulation.

This integration effort will include the core multivariable controller structure with the body tilt angle and thrust vector regulator as well as bank-to-turn autopilot.

✓ 4.0 Integrate Line-of-Sight Slave mode controller into simulation

✓ 5.0 Integrate waypoint-guidance mode controller into simulation

6.0 Assess performance and usability of the high-level controller functions

A simulation-based study will seek to answer the following questions:

- Is this controller intuitive and usable by an untrained pilot ?
- It the controller robust and stable under all operating conditions ?
- Can the operator over-drive the UAV, or does the software effectively limit his/her commands ?
- Can the controller be implemented with existing data-link interfaces ?

7.0 Perform a cost-performance build-up on the candidate systems and assess optimal cost vs. performance system

8.0 Investigate interfaces and expandability of current ground control stations and mission planning modules.

The last effort will be important to establish the basis for phase II planning. We will seek opportunities to acquire government-furnished ground station equipment which would represent the perceived direction of technology.

4.0 Related Work

Geneva Aerospace is currently under contract with Freewing Aerial Robotics, Inc. to assess the performance capability and to develop an operational autopilot for the Freewing Tilt-Body series of UAV's. In order to execute this contract, Geneva is also currently developing a Six Degree-of-Freedom simulation which accurately models the Freewing's unique kinematic and aerodynamic properties. These and the other significant development efforts are identified discussed:

University of Maryland, MATRA BAe and Texas A&M Wind Tunnel Tests

Freewing and its partners have logged over 560 hours of wind tunnel testing for use in the development of a Freewing Tilt-Body aerodynamics model. Researchers at the University of Maryland, Texas A&M University, and most recently, Geneva Aerospace have teamed to analyze the Freewing wind tunnel data and develop a realistic Freewing Tilt-Body vehicle aerodynamics model. Geneva Aerospace has integrated this aerodynamics model into a 6DOF simulation for use in the development of an automatic flight control system for the Freewing UAV. Geneva has also used this aerodynamics model to conduct a comprehensive vehicle performance assessment.

Boeing Instrumented Flight Test Series

Freewing has recently teamed with Boeing to conduct a comprehensive instrumented flight test program using the Scorpion Model 100-50. This flight test program is the first in a planned series of test programs to collect real flight test data which will be used to validate the Freewing aerodynamics model as well as the propeller, engine, and actuator models used in Geneva's 6DOF simulation. This flight test program along with the follow-on aerodynamics and simulation model updates will be completed prior to the AF98 Phase I SBIR contract award, providing both technical merit for entrance into a Phase I study effort as well as risk reduction for advancement to a Phase II flight test demonstration program.

Geneva Six Degree-of-Freedom Simulation

Geneva is currently developing a generic off-the-shelf six degree-of-freedom simulation to support this and several other design and analysis efforts. The long-term goal of this effort is to provide a validated and accredited core simulation package for missile, UAV, and aircraft development efforts. The simulation is highly modular and written in the C++ object-oriented language.

The Freewing dynamics model and aerodynamic database has been integrated into the generic 6DOF, which is currently being used for on-going performance evaluation and design trades.

Freewing Tilt-Body Development Program

Most recently Freewing has been in active development of a variant of its Scorpion Tilt-Body in collaboration with Europe's Matra BAe Dynamics. This variant, known as the "Marvel," is to be employed by the French Navy for use aboard its frigates and other surface combatants. This ambitious program is scheduled to demonstrate the suitability of the Scorpion platform in the late 1998 time-frame. The program gained a further boost amid indications that the French Army may consider a 60% scale version for its UAV reconnaissance needs.

Geneva's Integrated Guidance Systems Design Methodology

The desire for more use of COTS components in modern military applications calls for a modified systems engineering design approach. We feel that this can be done more effectively by focusing on the highest level requirements, and by designing the embedded controller to optimize the interactions between the subsystems. Geneva has developed a methodology which uses the framework of modern robust control theory to synthesize a controller, allowing us to assess the effects of degrading subsystem uncertainties on top-level performance. From there, a comprehensive Cost vs. Performance curve can be developed, whereby cost can truly be treated as an independent design variable. It is the merging of systems engineering, COTS subsystem procurement, and multivariable robust control theory that makes this approach so unique.

5.0 Relationship with Phase II Work

As the development of the Freewing aerial vehicle progresses, the guidance, navigation, and ground station systems must develop in parallel. Although an innovative guidance system architecture has been developed from projected mission profiles, several questions regarding the

usability of our design must be answered prior to entering full-scale system development. The results of the phase I research will provide the critical information needed to enter into the full-scale development of the integrated system.

With this information, Freewing and Geneva will propose a phase II integration and test plan with the goal of developing a complete low-cost UAV capable of interfacing with current and future ground stations, payloads, and seekers.

6.0 Company Information

Geneva Aerospace is a progressive engineering firm specializing in integrated flight control systems technology. Formed in 1995 and formally founded in early 1997 by several Members of the Group Technical Staff of Raytheon-TI Systems, Geneva's flight control systems team has a proven track record on various military weapon systems programs such as the U.S. military's Joint Standoff Weapon (JSOW), High-Speed Anti-Radiation Missile (HARM), and the Extended Range Guided Munitions (ERGM) weapon. Geneva's staff specializes in design and implementation of inertially guided autonomous glider weapons and maintains leading-edge expertise in robust real-time control system design techniques.

Freewing Aerial Robotics Corporation is one of a new breed of high-tech companies launched in university-based business incubators, in a special kind of public/private partnership, with its R&D partially funded by competitive government technology grants. Consulting and shareholding agreements with other engineers, such as Burt Rutan and John Roncz, expand Company capabilities. A number of Texas A&M University faculty members and graduate students also work extensively with Freewing. Freewing has been selected by European aerospace giant Matra BAe Dynamics as partner and vehicle subcontractor in a UAV proposal to the French government.

7.0 Key Personnel

David Allen Felio - Principal Investigator

Dave Felio has developed autonomously-guided weapon systems as an autopilot and guidance specialist at Texas Instruments Missile Systems Division for the past 11 years. He has had extensive experience developing anti-radiation homing missiles, GPS inertially guided glider weapons, and cannon-launched smart munitions. He is currently a Member of the Group Technical Staff at Raytheon-TI Systems, and has served as the lead G&C systems designer for the Joint Stand-Off Weapon System, RTIS's Interdiction Weapons Division, and several proprietary development programs. Mr. Felio holds a Masters of Mechanical Engineering with an emphasis in control theory from the University of Texas at Arlington, and a Bachelor's Degree in Electrical Engineering from Texas Tech University.

David Shane Duggan

Dave Duggan has developed missile systems as an autopilot and guidance specialist at Texas Instruments Missile Systems Division for the past 8 years. He has had extensive experience developing anti-radiation homing missiles, GPS inertially guided glider weapons, and precision guided imaging missiles. He is currently a member of the Group Technical Staff at Raytheon-II Systems, and has served as the lead G&C systems designer of the Unitary variant of the Joint Stand-Off Weapon system for the past 3 years. He currently holds the lead G&C systems functional position over RTIS's Interdiction Weapons Division. Mr. Duggan holds a Bachelor's Degree in Aerospace Engineering from the University of Texas, Arlington.

8.0 Facilities

Geneva Aerospace maintains state-of-the art computing platforms and engineering software to support analysis, simulation, and control system design work for Freewing. All hardware integration necessary for the studies will be conducted on-site at the Freewing facility in College Station.

Freewing's research and development laboratory is housed in a 20,000 ft² complex of four buildings in College Station, Texas. Freewing conducts its flight tests at an airport on the Riverside campus of Texas A&M University, which participates in flight testing as a subcontractor to Freewing.

Freewing has formed a business arrangement with L&L Tooling & Manufacturing, Inc. of Itasca, Texas, to acquire pre-production models of its Scorpion Tilt-Body and to gain production tooling. L&L is a premier maker of composites tooling, whose customer list includes Rockwell, Gulfstream and Bell Helicopter. Freewing's production line for the Scorpion Model 100-50, a 50-pound payload Freewing Tilt-Body UAV, is scheduled to open in 1997 in Texas. Several Scorpions have been produced from the soft production tooling. The final tooling will be capable of producing up to one aircraft per day.

Bibliography

- Porter, R.F., Hall, D.W., Brown J.H., Gregorek, G.M., "Analytical study of the Free-Wing Free-Trimmer Concept", NASA CR-2946, February 1978.
- Chen, W. & Barlow, J.B., "Stability, Control and Gust Response Characteristics of an Ultralight freewing Aircraft", AIAA-92-4342, Atmospheric Flight mechanics Meeting, Hilton Head, SC, August 10-12, 1992.
- Chen, W. & Barlow, J.B., "An Ultralight Freewing Aircraft Design Study", AIAA-92-4194, AIAA Aircraft Design System Meeting, Hilton Head, SC, August 24-26, 1992.
- Chen, W., "Stability, Control and Gust Sensitivity of a Low Wing Loading Freewing Airplane", M.S. Thesis, 1992.
- Barlow, J.B. & Chen, W., "Aerodynamic Characteristics and Control Aspects of a Freewing Tilt-Body Airplane", presented at the Twelfth Bristol International Conference on RPVs, 9-11 September 1996, Bristol, UK.

| | |
|--|-----------|
| 12. Total Costs | \$ 76,375 |
| 13. General and Administrative (15%) | \$ 11,456 |
| 14. Fee (7%) | \$ 5,346 |
| 15. Total Firm Fixed-Price Cost | \$ 93,177 |
| 16. Type of contract proposed: Firm-fixed-price. | |

17.

- a) Has any executive agency of the United States Government performed any review of your accounts or records in connection with any other government prime contract or subcontract within the past twelve months? No.
- b) Will you require the use of any government property in the performance of this proposal? No.
- c) Do you require government contract financing to perform this proposed contract? Yes. If yes, then specify type as advanced payments or progress payments. Progress Payments

David A. Felio
President

Date

1 **Exhibit 10 - Geneva Phase I Contract information for AF98-179**
2 from Air Force SBIR Web site at
3 <http://www.afsbirsttr.com/TechMall/Default.aspx?kwa=AF98-179>

- GOVERNMENT
- SMALL BUSINESS
- PRIME CONTRACTOR
- ACADEMIA

Program Office

Air Force Research
 Laboratory (AFRL/XPP)
 1864 4th Street
 Bldg 15 Rm 225
 Wright-Patterson AFB,
 OH
 45433
 Toll Free:
 1-800-222-0336
 Fax: (937) 255-2219

AWARD DETAILS

[Back to List](#) [Printer Friendly](#)

AIR FORCE

Proposal #: 98AL-306 **DoD Submission #:**
Phase: I **Program:** SBIR
Proposal Title: Examination of an Integrated Autopilot Design for Simplified UAV Flight Control
AF Sol Topic #: AF98-179 **DoD Technology Area:** Air Platforms
Solicitation #: 98.1 **Gov't Managing Office:** RH
Agency: AF **Gov't Sponsoring Office:**
Topic Title: Simplified Manual Flight Control

AWARD DETAILS

Status: Successful (Invited for Phase II)
Amount: 93177 **Contract:** F41624-98-C-5058
Start: 5/14/1998 12:00:00 AM **End:** 2/14/1999 12:00:00 AM
Annual Report FY: 1998
Transition Success Story written? **Impact Story Submitted? No**
HUBZone: No
TRL Level: Level 3
TRL Application: Analytical and experimental critical function and/or characteristic proof-o- concept
DTIC Rpt. Date: 3/20/2001 12:00:00 AM **DTIC Rpt. Num.:** AFRL-HE-WP-TR-1999-0017-
DTIC Accession Number: B242868

FIRM DETAILS

Firm: Geneva Aerospace, Inc. **Socially & Economically Disadvantaged Business?:** No
Address: PO Box 613018 **Woman Owned?:** No
City: Dallas **Veteran Owned?:** No
State: TX **Disabled Veteran Owned?:** No
Zip: 75261 **HBCU/MI:** No
Employees: 6 **HBCU/MI Name:**

CONTACT INFORMATION

Project Manager Name: David A. Felio
Project Manager Title: President
Project Manager Phone: (972) 317-3124
Project Manager Email:

Corp Official Name: David S. Duggan
Corp Official Title: Secretary and V.P.
Corp Official Phone: (940) 440-9312
Corp Official Email:

APPENDIX B

Abstract:
 In order to be truly versatile, Unmanned Aerial Vehicle (UAV) Systems must be usable to individuals who's training is more focused on the requirements of a given mission or on the usability of the payload, rather than on the aviation of the air vehicle. This

TOPIC/AWARD DATA

-
- [SEARCH TOPICS](#)
- [SEARCH AWARDS](#)

LOGIN

Please select the area you work within in relation to the SBIR & STTR programs from the menu on the left.

PUBLICATIONS

- [SBIR/STTR Advantage](#)
- [Innovation Stories](#)
- [Transition Stories](#)

1

2

Exhibit 11 - IDS From Duggan Provisional Application

3

No. 60/480,192



IFW

IN THE UNITED STATES PATENT AND TRADEMARK OFFICE

First Named Inventor : Dave Duggan et al.

Appln. No. : 60/480,192

Filed : June 20, 2003

For : METHOD AND APPARATUS FOR AUTONOMOUS AND SEMI-AUTONOMOUS COMMAND AND CONTROL OF UNMANNED AIR VEHICLE

Docket No.: G46.12-0001

Group Art Unit: ---

Examiner: ---

INFORMATION DISCLOSURE STATEMENT

Commissioner for Patents P.O. Box 1450 Alexandria, VA 22313-1450

I HEREBY CERTIFY THAT THIS PAPER IS BEING SENT BY U.S. MAIL, FIRST CLASS, TO THE COMMISSIONER FOR PATENTS, P.O. BOX 1450, ALEXANDRIA, VA 22313-1450, THIS

29th DAY OF July 2007 Christopher L. Hall PATENT ATTORNEY

Sir:

The patents or publications listed on the enclosed PTO Form-1449 are submitted pursuant to 37 C.F.R. § 1.97. Copies of the patents or publications cited are enclosed.

TIME OF FILING

The information disclosure statement is being filed:

- 1. X with the application or within three months of the filing date of the application or date of entry into the national stage of an international application or before the mailing date of a first Office action on the merits, whichever event occurs last. In accordance with 37 C.F.R. § 1.97(b), no statement or fee is required.
2. after the time period specified in paragraph 1 above, but before the mailing date of a final action under 37 C.F.R. § 1.113 or notice of allowance under 37 C.F.R. § 1.311. Therefore, in accordance with 37 C.F.R. § 1.97(c), submitted herewith is:
(check either A or B below)
A. a statement as specified in 37 C.F.R. § 1.97(e).

-2-

- B. the fee set forth in 37 C.F.R. § 1.17(p) for submission of an information disclosure statement under 37 C.F.R. § 1.97(c).

- 3. after the mailing date of either a final action under 37 C.F.R. § 1.113 or a notice of allowance under 37 C.F.R. § 1.311, whichever occurs first, but before payment of the issue fee. Therefore, Applicant petitions for consideration and submits herewith:
 - A. a statement as specified in 37 C.F.R. § 1.97(e);
 - B. the petition fee set forth in 37 C.F.R. § 1.17(p).

STATEMENT

(only used if No. 2(A) or No. 3 above is checked)

The person(s) signing below certify

(check appropriate paragraph)

that each item of information contained in this Information Disclosure Statement was first cited in any communication from a foreign patent office in a counterpart foreign application not more than three months prior to the filing of this statement. 37 C.F.R. § 1.97(e)(1).

OR

that no item of information contained in this Information Disclosure Statement was cited in a communication from a foreign patent office in a counterpart foreign application or, to the knowledge of the person signing the certification after making reasonable inquiry, was known to any individual designated in 37 C.F.R. § 1.56(c) more than three months prior to the filing of this statement. 37 C.F.R. § 1.97(e)(2).

METHOD OF PAYMENT

- No fee is required.
- Attached is a check in the amount of \$_____.

-3-

The Director is authorized to charge any fee deficiency required by this paper or credit any overpayment to Deposit Account No. 23-1123. A duplicate copy of this communication is enclosed.

Respectfully submitted,

WESTMAN, CHAMPLIN & KELLY, P.A.

By: Christopher L. Holt
Christopher L. Holt, Reg. No. 45,844
Suite 1600 - International Centre
900 Second Avenue South
Minneapolis, Minnesota 55402-3319
Phone: (612) 334-3222
Fax: (612) 334-3312

CLH/rkp



| | | |
|---|----------------------------------|--------------------------|
| FORM PTO-1449 | Atty. Docket No.: G46.12-0001 | Appl. No.: 10/871,612 |
| LIST OF PATENTS AND PUBLICATIONS FOR APPLICANT'S INFORMATION DISCLOSURE STATEMENT | First Named Inventor: | |
| | Dave Duggan et al. | |
| | Filing Date | Group Art: |
| | June 18, 2004 | --- |

U.S. PATENT DOCUMENTS

| Examiner Initial | Document No. | Date | Name | Class | Sub Class | Filing Date If Appropriate |
|------------------|--------------|---------|------------------|-------|-----------|----------------------------|
| AA | 5,214,584 | 05/1993 | Dingee et al. | 364 | 423 | |
| AB | 5,123,610 | 06/1992 | Oaks | 244 | 3.12 | |
| AC | 4,611,771 | 09/1986 | Gibbons et al. | 244 | 3.12 | |
| AD | 4,725,956 | 02/1988 | Jenkins | 364 | 434 | |
| AE | 5,522,567 | 06/1996 | Kinstler | 244 | 3.15 | |
| AF | 5,904,724 | 05/1999 | Margolin | 701 | 120 | |
| AG | 4,848,755 | 09/1989 | McNulty et al. | 364 | 434 | |
| AH | 4,642,774 | 02/1987 | Centala et al. | 364 | 434 | |
| AI | 5,951,609 | 09/1999 | Hanson et al. | 701 | 13 | |
| AJ | 5,951,607 | 09/1999 | Senn et al. | 701 | 1 | |
| AK | 5,944,762 | 08/1999 | Bessacini et al. | 701 | 27 | |

FOREIGN PATENT DOCUMENTS

| | Document No. | Date | Country | Class | Sub Class | Translation Yes No |
|----|--------------|------|---------|-------|-----------|--------------------|
| AL | | | | | | |
| AM | | | | | | |
| AN | | | | | | |

OTHER ART (Including Author, Title, Date, Pertinent Pages, Etc.)

| | |
|----|--|
| AO | |
| AP | |
| AQ | |

| | |
|-----------|------------------|
| EXAMINER: | DATE CONSIDERED: |
|-----------|------------------|

EXAMINER: Initial if citation considered, whether or not citation is in conformance with MPEP 609; draw line through citation if not in conformance and not considered. Include copy of this form with next communication to applicant.



| | | |
|---|----------------------------------|--------------------------|
| FORM PTO-1449 | Atty. Docket No.: G46.12-0001 | Appl. No.: 10/871,612 |
| LIST OF PATENTS AND PUBLICATIONS FOR APPLICANT'S INFORMATION DISCLOSURE STATEMENT | First Named Inventor: | |
| | Dave Duggan et al. | |
| | Filing Date | Group Art: |
| | June 18, 2004 | --- |

U.S. PATENT DOCUMENTS

| Examiner Initial | Document No. | Date | Name | Class | Sub Class | Filing Date If Appropriate |
|------------------|--------------|---------|------------------|-------|-----------|----------------------------|
| AR | 5,822,515 | 10/1998 | Baylocq | 395 | 185.09 | |
| AS | 5,782,429 | 07/1998 | Mead | 244 | 3.11 | |
| AT | 5,691,531 | 11/1997 | Harris et al. | 244 | 3.14 | |
| AU | 5,048,771 | 09/1991 | Siering | 244 | 3.15 | |
| AV | 5,042,743 | 08/1991 | Edwin R. Carney | 244 | 3.11 | |
| AW | 5,240,207 | 08/1993 | Eiband et al. | 244 | 190 | |
| AX | 5,938,148 | 08/1999 | Orenstein | 244 | 3.15 | |
| AY | 5,552,983 | 09/1996 | Thornberg et al. | 364 | 424.01 | |
| AZ | 5,181,673 | 01/1993 | Hubricht et al. | 244 | 3.12 | |
| BA | 5,605,307 | 02/1997 | Batchman et al. | 244 | 3.11 | |
| BB | | | | | | |

FOREIGN PATENT DOCUMENTS

| | Document No. | Date | Country | Class | Sub Class | Translation Yes No |
|----|--------------|------|---------|-------|-----------|--------------------|
| BC | | | | | | |
| BD | | | | | | |
| BE | | | | | | |

OTHER ART (Including Author, Title, Date, Pertinent Pages, Etc.)

| | |
|----|--|
| BF | |
| BG | |
| BH | |

EXAMINER:

DATE CONSIDERED:

EXAMINER: Initial if citation considered, whether or not citation is in conformance with MPEP 609; draw line through citation if not in conformance and not considered. Include copy of this form with next communication to applicant.