

**IN THE UNITED STATES PATENT AND TRADEMARK OFFICE**1  
2  
3  
4  
5  
6  
7  
8  
9  
10  
11  
12  
13  
14  
15  
16  
17  
18  
19  
20  
21  
22  
23  
24  
25  
26  
27

Application Serial No. 11/736,356

Filed: 04/17/2007

For: SYSTEM AND METHOD FOR SAFELY FLYING UNMANNED AERIAL VEHICLES  
IN CIVILIAN AIRSPACE

Examiner: Ronnie M. Mancho

Art Unit: 3664

In re Application of: Jed Margolin

Mail Stop Appeal Brief - Patents  
Commissioner for Patents  
P.O. Box 1450  
Alexandria, VA 22313-1450

Sir,

**Appeal Brief**

This is an appeal of the Rejection dated February 15, 2011 of twice-rejected claims 1-14. A Notice of Appeal was timely filed April 17, 2011. This Appeal Brief is timely filed within two months of that date. *Pro se* Appellant (“Margolin”) claims Small Entity Status. The filing fee of \$270 is being paid through the USPTO’s Electronic Filing System.

**Table of Contents**

This brief contains items under the following headings as required by 37 C.F.R. § 41.37 and M.P.E.P. § 1206:

1			
2			
3			
4			
5			
6	I.	Real Party In Interest .....	4
7	II.	Related Appeals and Interferences .....	4
8	III.	Status of Claims .....	4
9	IV.	Status of Amendments .....	4
10	V.	Summary of Claimed Subject Matter .....	5
11	VI.	Grounds of Rejection to be Reviewed on Appeal .....	13
12	VII.	Argument .....	14
13	VIII.	Claims Appendix .....	52
14	IX.	Evidence Appendix .....	52
15	Exhibit 1	Patent Application as filed .....	61
16	Exhibit 2	U.S. Patent 5,904,724 (Margolin).....	87
17	Exhibit 3	First Office Action on the Merits .....	102
18	Exhibit 4	U. S. Patent Application 20050004723 (Duggan) .....	115
19	Exhibit 5	Applicant's Response to First Office Action .....	193
20	Exhibit 6	Second Office Action .....	435
21	Exhibit 7	Applicant's Summary of Telephone Interview with	
22		Examiner .....	452
23	Exhibit 8	Applicant's Summary of Telephone Interview with	
24		Examiner's SPE .....	457
25	Exhibit 9	IDS References Considered by Examiner .....	461
26	Exhibit 10	<b>Sensing Requirements for Unmanned Air Vehicles,</b>	
27		AFRL Air Vehicles Directorate .....	465
28	Exhibit 11	<b>Developing Sense and Avoid Requirements for Meeting</b>	
29		<b>An Equivalent Level of Safety, Russel Wolfe .....</b>	469
30			

1	Exhibit 12	Article - <b>Lockheed's Polecat UCAV Demonstrator Crashes,</b>	
2		Aviation Week & Space Technology, by Amy Butler, 03/19/2007,	
3		page 44 .....	489
4			
5	Exhibit 13	Ex parte MAURICE GIVENS Appeal 2009-003414	
6		BPAI Informative Decision, Decided: August 6, 2009 .....	493
7			
8	Exhibit 14	Speech - " <b>Safety Must Come First</b> "; J. Randolph Babbitt,	
9		FAA Administrator; November 18, 2009, FAA Web site .....	498
10			
11	Exhibit 15	Article - <b>Pentagon Accident Reports Suggest Military's</b>	
12		<b>Drone Aircraft Plagued With Problems,</b> by David Zucchini, from	
13		The Ledger.com, July 6, 2010.	
14		<a href="http://www.theledger.com/article/20100706/NEWS/7065101">http://www.theledger.com/article/20100706/NEWS/7065101</a> ..	502
15			
16			
17	X.	Related Proceedings Appendix .....	506
18			

1 I. REAL PARTY IN INTEREST

2  
3 The real party in interest for this appeal is the *pro se* appellant:

4  
5 Jed Margolin  
6 1981 Empire Rd.  
7 Reno, NV 89521-7430  
8

9  
10 II. RELATED APPEALS, INTERFERENCES, AND JUDICIAL PROCEEDINGS

11  
12 There are no other appeals, interferences, or judicial proceedings which will directly  
13 affect or be directly affected by or have a bearing on the Board's decision in this appeal.  
14

15  
16 III. STATUS OF CLAIMS

17  
18 The Application as filed included claims 1-14.

19  
20 Claims 1-14 have been twice-rejected in the Office Action of February 15, 2011. Claims  
21 1-14 are being appealed.  
22

23  
24 IV. STATUS OF AMENDMENTS

25  
26 In response to the Final Office Action of February 15, 2011, a Notice of Appeal was  
27 filed on April 17, 2011. No formal amendments were filed either before or after the issuance of  
28 the Final Office Action of February 15, 2011.  
29



1 V. SUMMARY OF CLAIMED SUBJECT MATTER

2

3 Margolin's current invention is a system and method for safely flying an unmanned aerial  
 4 vehicle (UAV), unmanned combat aerial vehicle (UCAV), or remotely piloted vehicle (RPV) in  
 5 civilian airspace by using a remotely located pilot to control the aircraft using a synthetic vision  
 6 system during at least selected phases of the flight such as during take-offs and landings. The  
 7 current invention is a new and unobvious use for U.S. Patent 5,904,724 **Method and apparatus**  
 8 **for remotely piloting an aircraft** issued May 18, 1999 to Margolin. Appellant Margolin is the  
 9 same Margolin named as the inventor in 5,904,724 ('724) which was incorporated by reference  
 10 in the present application. (See Application Spec. page 2, lines 6 -19) The current application  
 11 solves a long unmet need, namely the ability to safely fly unmanned aerial vehicles in civilian  
 12 airspace.

13

Independent Claim 1	References
<p>1. A system for safely flying an unmanned aerial vehicle in civilian airspace comprising:</p> <p>(a) a ground station equipped with a synthetic vision system;</p> <p>(b) an unmanned aerial vehicle capable of supporting said synthetic vision system;</p> <p>(c) a remote pilot operating said ground station;</p> <p>(d) a communications link between said unmanned aerial vehicle and said ground station;</p>	<p>Spec. page 1, line 19 - page 2, line 19;          '724 Spec. Column 3, lines 28-49;          '724 Figures 4 and 5.</p> <p>Spec. page 1, line 19 - page 2, line 19;          '724 Spec. Column 4, lines 1-16;          '724 Figure 3.</p> <p>Spec. page 2, lines 6-19;          '724 Figure 1 #102.</p> <p>'724 Column 3, lines 59-67;          '724 Figure 1 #104, 105, 106.</p>

<p>(e) a system onboard said unmanned aerial vehicle for detecting the presence and position of nearby aircraft and communicating this information to said remote pilot;</p> <p>whereas said remote pilot uses said synthetic vision system to control said unmanned aerial vehicle during at least selected phases of the flight of said unmanned aerial vehicle, and during those phases of the flight of said unmanned aerial vehicle when said synthetic vision system is not used to control said unmanned aerial vehicle said unmanned aerial vehicle is flown using an autonomous control system.</p>	<p>Spec. page 5, lines 20-21; Spec. page 15, lines 23-27; '724 Column 4, line 66 - Column 5, line 5; '724 Figure 3 #307.</p> <p>Spec. page 4, line 32 - page 5, line 3; Spec. page 5, lines 13-15.</p>
--	--

1

<b>Dependent Claim 2</b>	<b>References</b>
<p>2. The system of claim 1 whereby said selected phases of the flight of said unmanned aerial vehicle comprise:</p> <p>(a) when said unmanned aerial vehicle is within a selected range of an airport or other designated location and is below a first specified altitude;</p> <p>(b) when said unmanned aerial vehicle is outside said selected range of an airport or other designated location and is below a second specified altitude.</p>	<p>Spec. page 5, lines 5-7; Figures 1 and 2.</p> <p>Spec. page 5, lines 8-9; Figures 1 and 2.</p>

2

Dependent Claim 3	References
<p>3. The system of claim 1 further comprising a system onboard said unmanned aerial vehicle for periodically transmitting the identification, location, altitude, and bearing of said unmanned aerial vehicle.</p>	<p>Spec. page 5, lines 17-19.</p>

1

Dependent Claim 4	References
<p>4. The system of claim 1 further comprising a system onboard said unmanned aerial vehicle for providing a communications channel for Air Traffic Control and the pilots of other aircraft to communicate directly with said remote pilot.</p>	<p>Spec. page 5, lines 22-23; Spec. page 16, lines 1-4.</p>

2

Independent Claim 5	References
<p>5. A system for safely flying an unmanned aerial vehicle in civilian airspace comprising:</p> <p>(a) a ground station equipped with a synthetic vision system;</p> <p>(b) an unmanned aerial vehicle capable of supporting said synthetic vision system;</p> <p>(c) a remote pilot operating said ground station;</p>	<p>Spec. page 1, line 19 - page 2, line 19; '724 Spec. Column 3, lines 28-49; '724 Figures 4 and 5.</p> <p>Spec. page 1, lines 19 - page 2, line 19; '724 Spec. Column 4, lines 1-16; '724 Figure 3.</p> <p>Spec. page 2, lines 6-19;</p>

<p>(d) a communications link between said unmanned aerial vehicle and said ground station;</p> <p>(e) a system onboard said unmanned aerial vehicle for detecting the presence and position of nearby aircraft and communicating this information to said remote pilot;</p> <p>whereas said remote pilot uses said synthetic vision system to control said unmanned aerial vehicle during at least selected phases of the flight of said unmanned aerial vehicle, and during those phases of the flight of said unmanned aerial vehicle when said synthetic vision system is not used to control said unmanned aerial vehicle said unmanned aerial vehicle is flown using an autonomous control system, and</p> <p>whereas the selected phases of the flight of said unmanned aerial vehicle comprise:</p> <p>(a) when said unmanned aerial vehicle is within a selected range of an airport or other designated location and is below a first specified altitude;</p> <p>(b) when said unmanned aerial vehicle is outside said selected range of an airport or other designated location and is below a second specified altitude.</p>	<p>'724 Figure 1 #102.</p> <p>'724 Column 3, lines 59-67; '724 Figure 1 #104, 105, 106;</p> <p>Spec. page 5, lines 20-21; Spec. page 15, lines 23-27; '724 Column 4, line 66 - Column 5, line 5; '724 Figure 3 #307.</p> <p>Spec. page 4, line 32 - page 5, line 3; Spec. page 5, lines 13-15.</p> <p>Spec. page 5, lines 5-7; Figures 1 and 2.</p> <p>Spec. page 5, lines 8-9; Figures 1 and 2.</p>
---	--

1

<b>Dependent Claim 6</b>	<b>References</b>
6. The system of claim 5 further comprising a system onboard said unmanned aerial vehicle for periodically transmitting the identification, location, altitude, and bearing of said unmanned aerial vehicle.	Spec. page 5, lines 17-19.

2

<b>Dependent Claim 7</b>	<b>Reference</b>
7. The system of claim 5 further comprising a system onboard said unmanned aerial vehicle for providing a communications channel for Air Traffic Control and the pilots of other aircraft to communicate directly with said remote pilot.	Spec. page 5, lines 22-23; Spec. page 16, lines 1-4.

3

<b>Independent Claim 8</b>	<b>References</b>
8. A method for safely flying an unmanned aerial vehicle as part of a unmanned aerial system equipped with a synthetic vision system in civilian airspace comprising the steps of:  (a) using a remote pilot to fly said unmanned aerial vehicle using synthetic vision during at least selected phases of the flight of said unmanned aerial vehicle, and during those phases of the flight of said unmanned aerial vehicle when said synthetic vision system is not used to control said unmanned aerial vehicle an autonomous control system is used to fly said	Spec. page 1, lines 19 - page 2, line 19; Spec. page 4, lines 32-34; Spec. page 5, lines 1-3; Spec. page 5, lines 13-15.

<p>unmanned aerial vehicle;</p> <p>(b) providing a system onboard said unmanned aerial vehicle for detecting the presence and position of nearby aircraft and communicating this information to said remote pilot.</p>	<p>Spec. page 5, lines 20-21;                  Spec. page 15, lines 23-27;                  '724 Column 4, line 66 - Column 5, line 5;                  '724 Figure 3 #307.</p>
--	---

1

<b>Dependent Claim 9</b>	<b>References</b>
<p>9. The method of claim 8 whereby said selected phases of the flight of said unmanned aerial vehicle comprise:</p> <p>(a) when said unmanned aerial vehicle is within a selected range of an airport or other designated location and is below a first specified altitude;</p> <p>(b) when said unmanned aerial vehicle is outside said selected range of an airport or other designated location and is below a second specified altitude.</p>	<p>Spec. page 5, lines 5-7;                  Figures 1 and 2.</p> <p>Spec. page 5, lines 8-9;                  Figures 1 and 2.</p>

2

<b>Dependent Claim 10</b>	<b>References</b>
<p>10. The method of claim 8 further comprising the step of providing a system onboard said unmanned aerial vehicle for periodically transmitting the identification, location, altitude, and bearing of said unmanned aerial vehicle.</p>	<p>Spec. page 5, lines 17-19.</p>

3

1

<b>Dependent Claim 11</b>	<b>References</b>
<p>11. The method of claim 8 further comprising the step of providing a system onboard said unmanned aerial vehicle for providing a communications channel for Air Traffic Control and the pilots of other aircraft to communicate directly with said remote pilot.</p>	<p>Spec. page 5, lines 22-23; Spec. page 16, lines 1-4.</p>

2

<b>Independent Claim 12</b>	<b>References</b>
<p>12. A method for safely flying an unmanned aerial vehicle as part of a unmanned aerial system equipped with a synthetic vision system in civilian airspace comprising the steps of:</p> <p>(a) using a remote pilot to fly said unmanned aerial vehicle using synthetic vision during at least selected phases of the flight of said unmanned aerial vehicle, and during those phases of the flight of said unmanned aerial vehicle when said synthetic vision system is not used to control said unmanned aerial vehicle an autonomous control system is used to fly said unmanned aerial vehicle;</p> <p>(b) providing a system onboard said unmanned aerial vehicle for detecting the presence and position of nearby aircraft and communicating this information to said remote pilot;</p>	<p>Spec. page 1, lines 19 - page 2, line 19; Spec. page 4, lines 32-34; Spec. page 5, lines 1-3; Spec. page 5, lines 13-15.</p> <p>Spec. page 5, lines 20-21; Spec. page 15, lines 23-27; '724 Column 4, line 66 - Column 5, line 5; '724 Figure 3 #307.</p>

<p>whereas said selected phases of the flight of said unmanned aerial vehicle comprise:</p> <p>(a) when said unmanned aerial vehicle is within a selected range of an airport or other designated location and is below a first specified altitude;</p> <p>(b) when said unmanned aerial vehicle is outside said selected range of an airport or other designated location and is below a second specified altitude.</p>	<p>Spec. page 5, lines 5-7; Figures 1 and 2.</p> <p>Spec. page 5, lines 8-9; Figures 1 and 2.</p>
--	---

1

<b>Dependent Claim 13</b>	<b>References</b>
<p>13. The method of claim 12 further comprising the step of providing a system onboard said unmanned aerial vehicle for periodically transmitting the identification, location, altitude, and bearing of said unmanned aerial vehicle.</p>	<p>Spec. page 5, lines 17-19.</p>

2

<b>Dependent Claim 14</b>	<b>References</b>
<p>14. The method of claim 12 further comprising the step of providing a system onboard said unmanned aerial vehicle for providing a communications channel for Air Traffic Control and the pilots of other aircraft to communicate directly with said remote pilot.</p>	<p>Spec. page 5, lines 22-23; Spec. page 16, lines 1-4.</p>

3



1 VI. GROUNDS OF REJECTION TO BE REVIEWED ON APPEAL

2

3 A. Claims 1-14 stand rejected under 35 U.S.C § 103(a) as being unpatentable over U.S. Patent  
4 5,904,724 ('724) to Margolin (the same Margolin as the Appellant) in view of Patent Publication  
5 US 2005004723 to Duggan.

6

7 B. Whether Margolin had a duty to define the term "civilian airspace" or whether he was  
8 entitled to use the common meaning of the term.

9

10 C. Whether Margolin had a duty to define "safety" or whether he was entitled to use the  
11 common meaning of the term; and whether Margolin defined a particular level of safety.

12

13 D. Whether the Examiner's assertion that "It is believed that the aircraft flown in the prior art is  
14 flown safely ..." (and which is asserted without evidence) is proper.

15

1 VII. ARGUMENT

2  
3 Ground A

4  
5 Claims 1-14 stand rejected under 35 U.S.C § 103(a) as being unpatentable over U.S. Patent  
6 5,904,724 ('724) to Margolin (the same Margolin as the Appellant) in view of Patent Publication  
7 US 2005004723 to Duggan.

8  
9 The following is a quotation of 35 U.S.C § 103(a):

10 (a) A patent may not be obtained though the invention is not identically disclosed or  
11 described as set forth in section 102 of this title, if the differences between the subject matter  
12 sought to be patented and the prior art are such that the subject matter as a whole would  
13 have been obvious at the time the invention was made to a person having ordinary skill in  
14 the art to which said subject matter pertains. Patentability shall not be negated by the  
15 manner in which the invention was made.

16 MPEP § 2142 states under the heading **ESTABLISHING A PRIMA FACIE CASE OF**  
17 **OBVIOUSNESS:**

18 a. **\*\*>The key to supporting any rejection under 35 U.S.C. 103 is the clear articulation**  
19 **of the reason(s) why the claimed invention would have been obvious.** The Supreme  
20 Court in *KSR International Co. v. Teleflex Inc.*, 550 U.S. \_\_\_, \_\_\_, 82 USPQ2d 1385, 1396  
21 (2007) noted that the analysis supporting a rejection under 35 U.S.C. 103 should be **made**  
22 **explicit.** The Federal Circuit has stated that "**rejections on obviousness cannot be**  
23 **sustained with mere conclusory statements; instead, there must be some articulated**  
24 **reasoning with some rational underpinning to support the legal conclusion of**  
25 **obviousness.**" In *re Kahn*, 441 F.3d 977, 988, 78 USPQ2d 1329, 1336 (Fed. Cir. 2006). See  
26 also *KSR*, 550 U.S. at \_\_\_, 82 USPQ2d at 1396 (quoting Federal Circuit statement with  
27 approval). <

28  
29 {Emphasis added}

30  
31 In the Examiner's 35 U.S.C. § 103(a) rejection he failed to make a prima facie case of  
32 obviousness.

33  
34 Margolin's current invention is a system and method for safely flying an unmanned aerial  
35 vehicle (UAV), unmanned combat aerial vehicle (UCAV), or remotely piloted vehicle (RPV) in

1 civilian airspace by using a remotely located pilot to control the aircraft using a synthetic vision  
2 system during at least selected phases of the flight such as during take-offs and landings.

3  
4 The current invention is a new and unobvious use for U.S. Patent 5,904,724 **Method and**  
5 **apparatus for remotely piloting an aircraft** issued May 18, 1999 to Margolin.  
6 Applicant/Appellant Margolin is the same Margolin named as the inventor in 5,904,724 ('724)  
7 which was incorporated by reference in the present application. From Application Spec. page 2,  
8 lines 6 -19:

9 [003] The use of Synthetic Vision in flying a UAV is taught by U.S. Patent 5,904,724  
10 **Method and apparatus for remotely piloting an aircraft** issued May 18, 1999 to  
11 Margolin (the present Applicant) which is hereby incorporated by reference.<sup>1</sup>  
12

13 **Claim 1 (Independent)**

14  
15 In claim 1, the new and unobvious use for '724 is in using synthetic vision during selected  
16 phases of the flight and during those phases of the flight where synthetic vision is not used, an  
17 autonomous control system is used. In claim 1 this element is:

18 whereas said remote pilot uses said synthetic vision system to control said unmanned aerial  
19 vehicle during at least selected phases of the flight of said unmanned aerial vehicle, and  
20 during those phases of the flight of said unmanned aerial vehicle when said synthetic vision  
21 system is not used to control said unmanned aerial vehicle said unmanned aerial vehicle is  
22 flown using an autonomous control system.  
23

24 The Examiner asserts that he found this element in '724 as follows, from Office Action dated  
25 September 1, 2010, page 3, second paragraph (Evidence Appendix Exhibit 3 at 105) and Office  
26 Action dated February 15, 2011, page 3, second paragraph (Evidence Appendix Exhibit 6 at  
27 438):

28 whereas said remote pilot uses said synthetic vision system (305, 306, 307, 311 on aircraft)  
29 to control said unmanned aerial vehicle 300 during at least selected phases of the flight of  
30 said unmanned aerial vehicle.

---

<sup>1</sup> In Margolin's telephone interview with the Examiner, the Examiner was unaware that Margolin (the current Applicant) is the same Margolin named as the inventor in '724. At one point during the interview the Examiner was confused as to whether Margolin was Margolin or Duggan. (See Summary of Telephone Interview with the Examiner, Evidence Appendix, Exhibit 7 at 452.)

1 He also finds it in Duggan, in Office Action dated September 1, 2010, page 3 (Evidence  
 2 Appendix Exhibit 3 at 105) and Office Action dated February 15, 2011, page 3 (Evidence  
 3 Appendix Exhibit 6 at 438):

4 Margolin did not disclose that the vehicle is flown using an autonomous control system.  
 5 However, Duggan teach of a system for safely flying an unmanned aerial vehicle in civilian  
 6 airspace comprising:

7  
 8 a ground station controlling an unmanned aerial vehicle (sec. 0352, 00353), wherein during  
 9 phases of a flight of an unmanned aerial vehicle (UAV, sec 0318, 0322, 0353) when a  
 10 synthetic vision (sec. 0356, 0365, 0388, 0390) is not used to control said unmanned aerial  
 11 vehicle said unmanned aerial vehicle is flown using an autonomous control system  
 12 (autopilot, sec 0346 to 0350, 0390-0329).  
 13

14 The Examiner’s references to ’724 are references in the figures, namely Figure 3. ’724 Figure 3  
 15 is reproduced here:

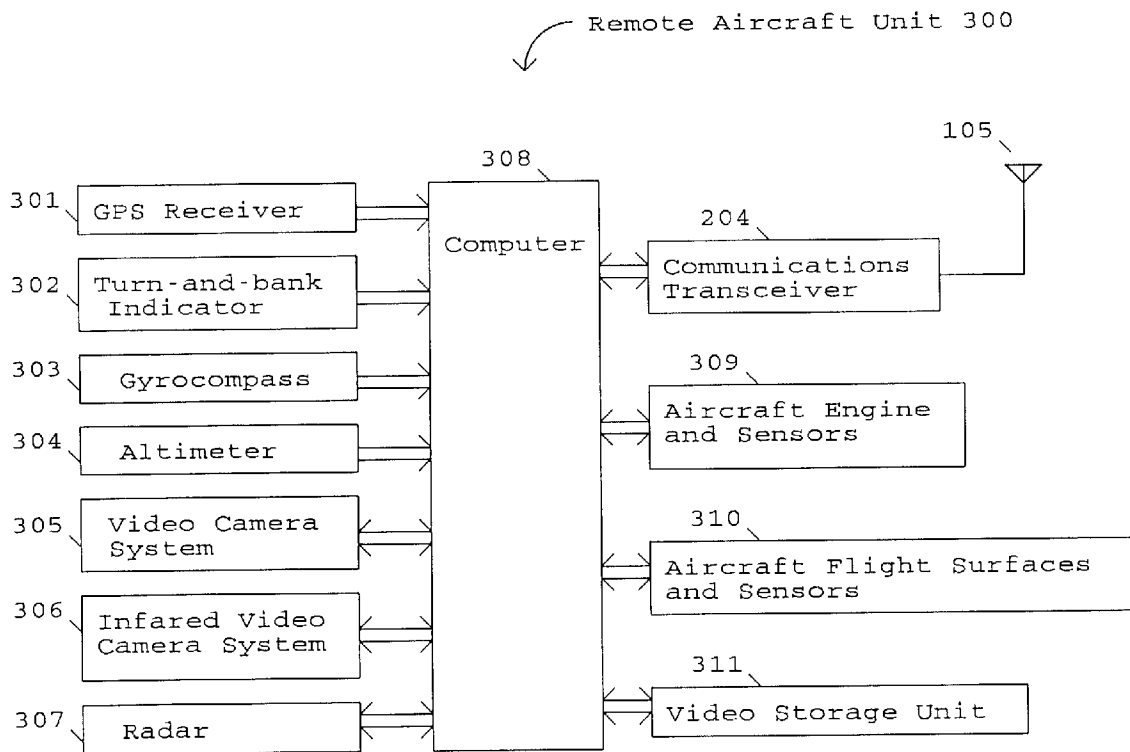

Fig. 3

16  
 17 The Examiner’s assertion that this shows “whereas said remote pilot uses said synthetic vision  
 18 system (305, 306, 307, 311 on aircraft) to control said unmanned aerial vehicle 300 during at

1 least selected phases of the flight of said unmanned aerial vehicle” goes beyond a broadest  
2 reasonable interpretation. It goes beyond even a broadest possible interpretation.

3

4 The same is true of the Duggan references cited by the Examiner:

5 a ground station controlling an unmanned aerial vehicle (sec. 0352, 00353), wherein during  
6 phases of a flight of an unmanned aerial vehicle (UAV, sec 0318, 0322, 0353) when a  
7 synthetic vision (sec. 0356, 0365, 0388, 0390) is not used to control said unmanned aerial  
8 vehicle said unmanned aerial vehicle is flown using an autonomous control system  
9 (autopilot, sec 0346 to 0350, 0390-0329).

10

11 Duggan:

12 [0352] In one aspect of the present invention, an operator station (also referred to as the  
13 ground control station or GCS) is designed to accommodate command and control of  
14 multiple vehicles or a single vehicle by a single operator. In accordance with one  
15 embodiment, the ground control station is platform independent and implements an  
16 application program interface that provides windowing and communications interfaces (e.g.,  
17 the platform is implemented in Open Source wxWindows API). The underlying operating  
18 system is illustratively masked and enables a developer to code in a high level environment.

19

20 [0353] In one embodiment, the ground control station incorporates several specialized user  
21 interface concepts designed to effectively support a single operator tasked to control  
22 multiple vehicles. The GCS also illustratively supports manual control and sensor steering  
23 modes. In the manual control mode, the operator can assume control authority of the  
24 vehicles individually from the ground control station at any time in flight. In the sensor  
25 steering mode, a vehicle will autonomously fly in the direction the operator is manually  
26 pointing the on-board imaging sensor (e.g., operator views video output from a digital  
27 camera on a TV interface, computer screen display, etc.). A custom data link is illustratively,  
28 utilized to support a two-way transfer of data between the ground control station and the  
29 UAV's. These design concepts together provide a flexible, multiple vehicle control system.  
30 The details of the concepts are discussed below.

31

32 [0318] If the pilot chooses a surveillance location outside the total FOV, then the outer loop  
33 guidance will illustratively follow a command-to-LOS mode guide law until the UAV flight  
34 path points toward the target. Once the desired staring-point comes within a minimum range  
35 threshold, the guidance automatically trips into a loiter pattern (either constant-radius or  
36 elliptical) to maintain a station with a single key-click while he/she conducts other activities.  
37 FIGS. 22A & 22B together demonstrate the surveillance-point approach scenario.

38

39 [0322] In accordance with one aspect of the present invention, sensor-slave mode commands  
40 are generated by an autonomous line-of-sight driven function, in which the command  
41 objectives are generated by the necessities of the function rather than by an operator. For  
42 example, a function designed to command a raster-scan of a particular surveillance area, or a  
43 function designed to scan a long a roadway could be used to generate sensor slave

1 commands. Another example is a function designed to generate line-of-sight commands for  
2 UAV-to-UAV rendezvous formation flying.

3  
4 [0353] In one embodiment, the ground control station incorporates several specialized user  
5 interface concepts designed to effectively support a single operator tasked to control  
6 multiple vehicles. The GCS also illustratively supports manual control and sensor steering  
7 modes. In the manual control mode, the operator can assume control authority of the  
8 vehicles individually from the ground control station at any time in flight. In the sensor  
9 steering mode, a vehicle will autonomously fly in the direction the operator is manually  
10 pointing the on-board imaging sensor (e.g., operator views video output from a digital  
11 camera on a TV interface, computer screen display, etc.). A custom data link is illustratively,  
12 utilized to support a two-way transfer of data between the ground control station and the  
13 UAV's. These design concepts together provide a flexible, multiple vehicle control system.  
14 The details of the concepts are discussed below.

15  
16 [0356] a synthetic vision display

17  
18 [0365] The two video monitors are illustratively used to display real-time data linked camera  
19 imagery from two air vehicles having cameras (of course, fewer, more or none of the  
20 vehicles might have cameras and the number of monitor displays can be altered  
21 accordingly). In accordance with one embodiment, camera imagery is recorded on  
22 videotapes during a mission. In accordance with one embodiment, the two repeater displays  
23 are used to provide redundant views of the GUI and synthetic vision display. The laptop  
24 illustratively serves as a GUI backup in the event that the main GUI fails.

25  
26 [0388] In one aspect of the present invention, synthetic vision display technical approach of  
27 the present invention is based upon integrating advanced simulated visuals, originally  
28 developed for training purposes, into UAV operational systems. In accordance with one  
29 embodiment, the simulated visuals are integrated with data derived from the ground control  
30 station during flight to enable real-time synthetic visuals.

31  
32 [0390] In one aspect of the present invention, through GUI display 2622, an operator can  
33 maintain a variable level of control over a UAV, from fully manual to fully autonomous,  
34 with simple user-friendly inputs. For example, if an operator decides to divert a UAV to a  
35 new route, the operator has a plurality of options to select from. The following are examples  
36 of some of the options that an operator has. Those skilled in the art should recognize that  
37 this is not an exhaustive list. In one embodiment, the operator could graphically edit the  
38 existing route on mission situation display 2629 by adding a waypoint or orbit pattern in the  
39 vicinity of a desired target region. Prior to accepting the edited route, the control system  
40 evaluates the revised route against the vehicle performance capability as well as terrain  
41 obstructions. If the route is within acceptable bounds, the control system registers the  
42 modified route and maneuvers the vehicle accordingly. In another embodiment, the operator  
43 could select a park mode on selections pane 2630. After selected, the control system queues  
44 the operator to click the location of and graphical size (via a mouse) the desired orbit pattern  
45 in which the vehicle will fly while "parked" over a desired target. In another embodiment,  
46 the operator can select a manual control mode on selections pane 2630. By selecting RDC

1 (remote directional command), for example, the control system controls the UAV into a  
 2 constant altitude, heading and speed flight until the operator instructs a maneuver. While in  
 3 RDC mode, the operator can either pseudo-manually direct the UAV using the control stick  
 4 (e.g. joystick) or the operator can program a fixed heading, altitude and speed using the  
 5 control options provided in selections pane 2630.  
 6

7 [0346] In accordance with one embodiment, an exemplary translation layer implementation  
 8 will now be provided. After the guidance algorithms execute, the outputs are translated to  
 9 the native vehicle autopilot commands. The equations below provide example kinematic  
 10 translations from the guidance acceleration commands to native vehicle autopilot  
 11 commands. These equations demonstrate the principal that vehicle motion is activated  
 12 through acceleration. The methods that various vehicles employ to generate acceleration are  
 13 numerous (bank angle autopilot, acceleration autopilot, heading control autopilot, altitude  
 14 control autopilot, etc). Since the control algorithms described herein generate acceleration  
 15 commands that can be kinematically translated into any of these native autopilot commands,  
 16 the guidance algorithms truly provide a generalized library of control laws that can control  
 17 any vehicle through that vehicle's native atomic functions. Ubiquitous acceleration control  
 18 techniques enable VACS to synthesize control commands for any vehicle, including air,  
 19 ground, or sea-based.  $a_v$  = vertical plane acceleration command  $a_h$  = horizontal plane  
 20 acceleration command  $\theta = \tan^{-1}(a_h/a_v)$  = bank angle command  $a_T = a_v^2 + a_h^2$  = total  
 21 body acceleration command  $\dot{\theta} = a_h/V$  = turn rate command  $\dot{\psi} = \dot{\theta} + \dot{\psi}$  = heading command  
 22  $\dot{\psi} = (a_v - g)/V$  = flight path rate command  $\psi = \psi - 1 + \dot{\psi} \cdot t$  = flight path angle command  $\dot{h} = V$   
 23  $\sin(\theta)$  = climb rate command  $\dot{h} = \dot{h} = 1 + \dot{h} \cdot t$  = altitude command Eq. 57  
 24

25 [0347] Additional functionality that can be enabled in a translation layer is means for  
 26 discouraging or preventing an operator (e.g., the human or non-human operator interfacing  
 27 the VACS architecture) from overdriving, stalling, or spinning the vehicle frame. This being  
 28 said, limiting algorithms can also be employed in the guidance or autopilot functions.  
 29

30 [0348] X. Autopilot  
 31

32 [0349] As has been addressed, the present invention is not limited to, and does not require, a  
 33 particular autopilot system. The control system and architecture embodiments of the present  
 34 invention can be adapted to accommodate virtually any autopilot system.  
 35

36 [0350] For the purpose of providing an example, an illustrative suitable autopilot software  
 37 system will now be described. The illustrative autopilot system incorporates a three-axis  
 38 design (pitch and yaw with an attitude control loop in the roll axis) for vehicle stabilization  
 39 and guidance command tracking. The autopilot software design incorporates flight control  
 40 techniques, which allow vehicle control algorithms to dynamically adjust airframe  
 41 stabilization parameters in real-time during flight. The flight computer is programmed  
 42 directly with the airframe physical properties, so that it can automatically adjust its settings  
 43 with changes in airframe configuration, aerodynamic properties, and/or flight state. This  
 44 provides for a simple and versatile design, and possesses the critical flexibility needed when  
 45 adjustments to the airframe configuration become necessary. The three-loop design includes  
 46 angular rate feedback for stability augmentation, attitude feedback for closed-loop stiffness,

1 and acceleration feedback for command tracking. In addition, an integral controller in the  
2 forward loop illustratively provides enhanced command tracking, low frequency disturbance  
3 rejection and an automatic trim capability.  
4

5 The Examiner then refers to the range 0390-0329. In Margolin's Response to the First Office  
6 Action of September 1, 2010 he pointed out that this range did not make sense. From Evidence  
7 Appendix Exhibit 5 at 205:

8 {The Examiner may have meant 0390-0392. Otherwise the range is not credible}  
9

10 Margolin assumed (and still assumes) that the Examiner meant 0390-0392.

11  
12 And yet, in the Second Office Action (February 15, 2011), the Examiner makes the same  
13 mistake. See Evidence Appendix Exhibit 6 at 438. This calls into question the Examiner's  
14 statement that "Applicant's arguments filed 11/29/10 have been fully considered but they are not  
15 persuasive." (See Evidence Appendix Exhibit 6 at 445.) The real reason that the Examiner did  
16 not find Margolin's arguments persuasive is because he did not read them. He also did not read  
17 the Specification in the Application or he would have known that Applicant (and now Appellant)  
18 Margolin is also the Margolin in '724.

19  
20 Here is Duggan 0390-0392:

21 [0390] In one aspect of the present invention, through GUI display 2622, an operator can  
22 maintain a variable level of control over a UAV, from fully manual to fully autonomous,  
23 with simple user-friendly inputs. For example, if an operator decides to divert a UAV to a  
24 new route, the operator has a plurality of options to select from. The following are examples  
25 of some of the options that an operator has. Those skilled in the art should recognize that  
26 this is not an exhaustive list. In one embodiment, the operator could graphically edit the  
27 existing route on mission situation display 2629 by adding a waypoint or orbit pattern in the  
28 vicinity of a desired target region. Prior to accepting the edited route, the control system  
29 evaluates the revised route against the vehicle performance capability as well as terrain  
30 obstructions. If the route is within acceptable bounds, the control system registers the  
31 modified route and maneuvers the vehicle accordingly. In another embodiment, the operator  
32 could select a park mode on selections pane 2630. After selected, the control system queues  
33 the operator to click the location of and graphical size (via a mouse) the desired orbit pattern  
34 in which the vehicle will fly while "parked" over a desired target. In another embodiment,  
35 the operator can select a manual control mode on selections pane 2630. By selecting RDC  
36 (remote directional command), for example, the control system controls the UAV into a  
37 constant altitude, heading and speed flight until the operator instructs a maneuver. While in  
38 RDC mode, the operator can either pseudo-manually direct the UAV using the control stick



1 (e.g. joystick) or the operator can program a fixed heading, altitude and speed using the  
2 control options provided in selections pane 2630.

3  
4 [0391] The described Intelligent displays with smart variables represent an effective  
5 approach to actively displaying information for different types of vehicles. However, a  
6 problem can arise when a new vehicle is integrated into the ground control station with a  
7 completely foreign command and control interface. Under these circumstances, the ground  
8 control station is not concerned about displaying data, but is tasked to provide a command  
9 and control interface for the operator to perform the required operations. This conundrum is  
10 the motivation for another embodiment of the present invention, namely, the integration of  
11 vehicle specific panels in the ground control station.

12  
13 [0392] In one embodiment, a generic vehicle class (GVC) is illustratively a software  
14 component that provides a rapid development environment API to add new vehicle classes  
15 and types to the ground control station. The GVC also illustratively serves as a software  
16 construct that allows the inclusion of multiple vehicles within the ground control station  
17 framework. One of the variables in the application is a vector of pointers to a generic vehicle  
18 class. This list is constructed by allocating new specific vehicles and returning a type case to  
19 the base generic vehicle class. When a new vehicle is integrated into the ground control  
20 station, the generic vehicle class provides all of the virtual functions to integrate with system  
21 control components (e.g., to integrate with a map display, a communications package, PCIG  
22 imagery and/or appropriate display windows). An important object in the application  
23 framework is illustratively a pointer to the current vehicle generic class. When the user  
24 switches vehicles, this pointer is updated and all displays grab the appropriate smart  
25 variables from the pointer to the new base class. This is the mechanism by which windows  
26 immediately update to the current vehicle information whenever the user switches vehicles.  
27 The default windows use the pointer to the current vehicle to grab information. In this  
28 manner, if the user switches to a new vehicle with a different set of datalink variables, that  
29 fact is immediately apparent on the display windows.

30  
31 Not only do the Duggan citations fail to support a broadest reasonable interpretation (or even a  
32 broadest possible interpretation) for the Examiner's assertion, they amount to a series of non  
33 sequiturs.

34  
35 They certainly fail to make a *prima facie* case for rejection.

36  
37 In addition, although the Examiner's rejection of claim 1 in both the Office Action of September  
38 1, 2010 (Evidence Appendix Exhibit 3 at 102) and in February 15, 2011 (Evidence Appendix  
39 Exhibit 6 at 435) are almost identical, the Examiner added some language to the February 15,  
40 2011 rejection.

1

The September 1, 2010 rejection, page 3; Evidence Appendix Exhibit 3 at 105:	February 15, 2011 rejection, page 3; Evidence Appendix Exhibit 6 at 438:
<p>whereas said remote pilot uses said synthetic vision system (305, 306, 307, 311 on aircraft) to control said unmanned aerial vehicle 300 during at least selected phases of the flight of said unmanned aerial vehicle.</p> <p>Margolin did not disclose that the vehicle is flown using an autonomous control system. However, Duggan teach of a system for safely flying an unmanned aerial vehicle in civilian airspace comprising:</p>	<p>whereas said remote pilot uses said synthetic vision system (305, 306, 307, 311 on aircraft; col. 5, lines 50-60) to control said unmanned aerial vehicle 300 during at least selected phases of the flight of said unmanned aerial vehicle (<b>selected phases implies some or all phases during flight</b>).</p> <p>Margolin did not disclose that the vehicle is flown using an autonomous control system (<b>e.g. autopilot</b>). However, Duggan teach of a system for safely flying an unmanned aerial vehicle in civilian airspace comprising:</p>

2

3 The added language (**selected phases implies some or all phases during flight**) might be a  
4 benign addition but probably isn't. Otherwise the Examiner would not have added it. Margolin  
5 intended that the phases be selected. The phrases "some or all phases" is broader and includes  
6 "all phases" which is clearly not Margolin's intent.

7

8 The added language (**e.g. autopilot**) is definitely not benign. An autonomous control system is  
9 much more than an autopilot. Margolin does not equate the two.

10

11 By making the second rejection final the Examiner has denied Margolin the opportunity to  
12 respond to these additions to the second rejection.

13

14

### 15 **Claim 2 (Dependent)**

16

17 Claim 2 is a dependent claim, dependent on Claim 1. Margolin has shown that Claim 1 is  
18 nonobvious. Therefore, under **2143.03 All Claim Limitations Must Be Considered**, Claim 2 is  
19 non-obvious.

### 20 **2143.03 All Claim Limitations Must Be ~~\*\*>~~Considered< [R-6]**

21 **\*\*** "All words in a claim must be considered in judging the patentability of that claim  
22 against the prior art." *In re Wilson*, 424 F.2d 1382, 1385, 165 USPQ 494, 496 (CCPA 1970).  
23 If an independent claim is nonobvious under 35 U.S.C. 103, then any claim depending  
24 therefrom is nonobvious. *In re Fine*, 837 F.2d 1071, 5 USPQ2d 1596 (Fed. Cir. 1988).

1 **Claim 3 (Dependent)**

2

3 Claim 3 is a dependent claim, dependent on Claim 1. Margolin has shown that Claim 1 is  
4 nonobvious. Therefore, under **2143.03 All Claim Limitations Must Be Considered**, Claim 3 is  
5 non-obvious.

6

7 **Claim 4 (Dependent)**

8

9 Claim 4 is a dependent claim, dependent on Claim 1. Margolin has shown that Claim 1 is  
10 nonobvious. Therefore, under **2143.03 All Claim Limitations Must Be Considered**, Claim 4 is  
11 non-obvious.

12

13 **Claim 5 (Independent)**

14

15 In claim 5, the new and unobvious use for '724 is in using synthetic vision during selected  
16 phases of the flight and during those phases of the flight where synthetic vision is not used, an  
17 autonomous control system is used, and further, that the selected phases comprise (a) when the  
18 unmanned aerial vehicle is within a selected range of an airport or other designated location and  
19 is below a first specified altitude, and (b) when said unmanned aerial vehicle is outside said  
20 selected range of an airport or other designated location and is below a second specified altitude.

21

22 In claim 5 this element is:

23       whereas said remote pilot uses said synthetic vision system to control said unmanned aerial  
24       vehicle during at least selected phases of the flight of said unmanned aerial vehicle, and  
25       during those phases of the flight of said unmanned aerial vehicle when said synthetic vision  
26       system is not used to control said unmanned aerial vehicle said unmanned aerial vehicle is  
27       flown using an autonomous control system, and

28

29       whereas the selected phases of the flight of said unmanned aerial vehicle comprise:

30

31       (a) when said unmanned aerial vehicle is within a selected range of an airport or other  
32       designated location and is below a first specified altitude;

33

34       (b) when said unmanned aerial vehicle is outside said selected range of an airport or other  
35       designated location and is below a second specified altitude.

36

1 However, whereas in the Examiner's rejection of claim 1 he made at least some attempt to  
2 indentify the different elements in '724, in his rejection of claim 5 he simply cited the following:  
3 *abstract; figs. 1-7; col. 3, lines 8-67; col. 4, lines 1-67; col. 5, lines 1-67*. See Office Action dated  
4 September 1, 2010, page 4, last paragraph (Evidence Appendix Exhibit 3 at 106) and Office  
5 Action dated February 15, 2011, page 4, last paragraph (Evidence Appendix Exhibit 6 at 439).

6  
7 The three passages cited in '724 (Column 3, lines 8-67; Column 4, lines 1-67; and Column 5,  
8 lines 1-67) form a continuous passage from Column 3, line 8 to Column 5, line 67. This passage  
9 of approximately 1619 words forms the core of the '724 DETAILED DESCRIPTION. The  
10 Examiner also cited all of the drawings and the abstract.

11  
12 Breaking the long contiguous passage of approximately 1619 words into three sections is  
13 misleading. By doing this the Examiner shows awareness of his failure to make a prima facie  
14 case for rejection. Or, perhaps it was simply laziness.

15

16 The Examiner did cite Duggan in one of the elements, but only one:

17 a ground station controlling an unmanned aerial vehicle (sec. 0352, 00353), wherein during  
18 phases of a flight of an unmanned aerial vehicle (UAV, sec 0318, 0322, 0353) when a  
19 synthetic vision (sec. 0356, 0365, 0388, 0390) is not used to control said unmanned aerial  
20 vehicle said unmanned aerial vehicle is flown using an autonomous control system  
21 (autopilot, sec 0346 to 0350, 0390-0329).

22

23 As with claim 1, the Duggan references are irrelevant. And again, the Examiner repeats the  
24 mistake of referring to 0390-0329.

25 Duggan:

26 [0352] In one aspect of the present invention, an operator station (also referred to as the  
27 ground control station or GCS) is designed to accommodate command and control of  
28 multiple vehicles or a single vehicle by a single operator. In accordance with one  
29 embodiment, the ground control station is platform independent and implements an  
30 application program interface that provides windowing and communications interfaces (e.g.,  
31 the platform is implemented in Open Source wxWindows API). The underlying operating  
32 system is illustratively masked and enables a developer to code in a high level environment.

33

34 [0353] In one embodiment, the ground control station incorporates several specialized user  
35 interface concepts designed to effectively support a single operator tasked to control  
36 multiple vehicles. The GCS also illustratively supports manual control and sensor steering  
37 modes. In the manual control mode, the operator can assume control authority of the

1 vehicles individually from the ground control station at any time in flight. In the sensor  
2 steering mode, a vehicle will autonomously fly in the direction the operator is manually  
3 pointing the on-board imaging sensor (e.g., operator views video output from a digital  
4 camera on a TV interface, computer screen display, etc.). A custom data link is illustratively,  
5 utilized to support a two-way transfer of data between the ground control station and the  
6 UAV's. These design concepts together provide a flexible, multiple vehicle control system.  
7 The details of the concepts are discussed below.  
8

9 [0318] If the pilot chooses a surveillance location outside the total FOV, then the outer loop  
10 guidance will illustratively follow a command-to-LOS mode guide law until the UAV flight  
11 path points toward the target. Once the desired staring-point comes within a minimum range  
12 threshold, the guidance automatically trips into a loiter pattern (either constant-radius or  
13 elliptical) to maintain a station with a single key-click while he/she conducts other activities.  
14 FIGS. 22A & 22B together demonstrate the surveillance-point approach scenario.  
15

16 [0322] In accordance with one aspect of the present invention, sensor-slave mode commands  
17 are generated by an autonomous line-of-sight driven function, in which the command  
18 objectives are generated by the necessities of the function rather than by an operator. For  
19 example, a function designed to command a raster-scan of a particular surveillance area, or a  
20 function designed to scan a long a roadway could be used to generate sensor slave  
21 commands. Another example is a function designed to generate line-of-sight commands for  
22 UAV-to-UAV rendezvous formation flying.  
23

24 [0353] In one embodiment, the ground control station incorporates several specialized user  
25 interface concepts designed to effectively support a single operator tasked to control  
26 multiple vehicles. The GCS also illustratively supports manual control and sensor steering  
27 modes. In the manual control mode, the operator can assume control authority of the  
28 vehicles individually from the ground control station at any time in flight. In the sensor  
29 steering mode, a vehicle will autonomously fly in the direction the operator is manually  
30 pointing the on-board imaging sensor (e.g., operator views video output from a digital  
31 camera on a TV interface, computer screen display, etc.). A custom data link is illustratively,  
32 utilized to support a two-way transfer of data between the ground control station and the  
33 UAV's. These design concepts together provide a flexible, multiple vehicle control system.  
34 The details of the concepts are discussed below.  
35

36 [0356] a synthetic vision display  
37

38 [0365] The two video monitors are illustratively used to display real-time data linked camera  
39 imagery from two air vehicles having cameras (of course, fewer, more or none of the  
40 vehicles might have cameras and the number of monitor displays can be altered  
41 accordingly). In accordance with one embodiment, camera imagery is recorded on  
42 videotapes during a mission. In accordance with one embodiment, the two repeater displays  
43 are used to provide redundant views of the GUI and synthetic vision display. The laptop  
44 illustratively serves as a GUI backup in the event that the main GUI fails.  
45

1 [0388] In one aspect of the present invention, synthetic vision display technical approach of  
 2 the present invention is based upon integrating advanced simulated visuals, originally  
 3 developed for training purposes, into UAV operational systems. In accordance with one  
 4 embodiment, the simulated visuals are integrated with data derived from the ground control  
 5 station during flight to enable real-time synthetic visuals.  
 6

7 [0390] In one aspect of the present invention, through GUI display 2622, an operator can  
 8 maintain a variable level of control over a UAV, from fully manual to fully autonomous,  
 9 with simple user-friendly inputs. For example, if an operator decides to divert a UAV to a  
 10 new route, the operator has a plurality of options to select from. The following are examples  
 11 of some of the options that an operator has. Those skilled in the art should recognize that  
 12 this is not an exhaustive list. In one embodiment, the operator could graphically edit the  
 13 existing route on mission situation display 2629 by adding a waypoint or orbit pattern in the  
 14 vicinity of a desired target region. Prior to accepting the edited route, the control system  
 15 evaluates the revised route against the vehicle performance capability as well as terrain  
 16 obstructions. If the route is within acceptable bounds, the control system registers the  
 17 modified route and maneuvers the vehicle accordingly. In another embodiment, the operator  
 18 could select a park mode on selections pane 2630. After selected, the control system queues  
 19 the operator to click the location of and graphical size (via a mouse) the desired orbit pattern  
 20 in which the vehicle will fly while "parked" over a desired target. In another embodiment,  
 21 the operator can select a manual control mode on selections pane 2630. By selecting RDC  
 22 (remote directional command), for example, the control system controls the UAV into a  
 23 constant altitude, heading and speed flight until the operator instructs a maneuver. While in  
 24 RDC mode, the operator can either pseudo-manually direct the UAV using the control stick  
 25 (e.g. joystick) or the operator can program a fixed heading, altitude and speed using the  
 26 control options provided in selections pane 2630.  
 27

28 [0346] In accordance with one embodiment, an exemplary translation layer implementation  
 29 will now be provided. After the guidance algorithms execute, the outputs are translated to  
 30 the native vehicle autopilot commands. The equations below provide example kinematic  
 31 translations from the guidance acceleration commands to native vehicle autopilot  
 32 commands. These equations demonstrate the principal that vehicle motion is activated  
 33 through acceleration. The methods that various vehicles employ to generate acceleration are  
 34 numerous (bank angle autopilot, acceleration autopilot, heading control autopilot, altitude  
 35 control autopilot, etc). Since the control algorithms described herein generate acceleration  
 36 commands that can be kinematically translated into any of these native autopilot commands,  
 37 the guidance algorithms truly provide a generalized library of control laws that can control  
 38 any vehicle through that vehicle's native atomic functions. Ubiquitous acceleration control  
 39 techniques enable VACS to synthesize control commands for any vehicle, including air,  
 40 ground, or sea-based.  $a_v$  = vertical plane acceleration command  $a_h$  = horizontal plane  
 41 acceleration command  $\theta = \tan^{-1} ( a_h / a_v )$  = bank angle command  $T = a_v^2 + a_h^2$  = total  
 42 body acceleration command  $\dot{\theta} = \dot{\theta} - 1 + \dot{\theta}$  = heading command  
 43  $\dot{\theta} = ( a_v - g ) / V$  = flight path rate command  $\dot{\theta} = \dot{\theta} - 1 + \dot{\theta}$  = flight path angle command  $\dot{h} = V$   
 44  $\sin(\theta)$  = climb rate command  $\dot{h} = \dot{h} - 1 + \dot{h}$  = altitude command Eq . 57  
 45

1 [0347] Additional functionality that can be enabled in a translation layer is means for  
2 discouraging or preventing an operator (e.g., the human or non-human operator interfacing  
3 the VACS architecture) from overdriving, stalling, or spinning the vehicle frame. This being  
4 said, limiting algorithms can also be employed in the guidance or autopilot functions.  
5

6 [0348] X. Autopilot  
7

8 [0349] As has been addressed, the present invention is not limited to, and does not require, a  
9 particular autopilot system. The control system and architecture embodiments of the present  
10 invention can be adapted to accommodate virtually any autopilot system.  
11

12 [0350] For the purpose of providing an example, an illustrative suitable autopilot software  
13 system will now be described. The illustrative autopilot system incorporates a three-axis  
14 design (pitch and yaw with an attitude control loop in the roll axis) for vehicle stabilization  
15 and guidance command tracking. The autopilot software design incorporates flight control  
16 techniques, which allow vehicle control algorithms to dynamically adjust airframe  
17 stabilization parameters in real-time during flight. The flight computer is programmed  
18 directly with the airframe physical properties, so that it can automatically adjust its settings  
19 with changes in airframe configuration, aerodynamic properties, and/or flight state. This  
20 provides for a simple and versatile design, and possesses the critical flexibility needed when  
21 adjustments to the airframe configuration become necessary. The three-loop design includes  
22 angular rate feedback for stability augmentation, attitude feedback for closed-loop stiffness,  
23 and acceleration feedback for command tracking. In addition, an integral controller in the  
24 forward loop illustratively provides enhanced command tracking, low frequency disturbance  
25 rejection and an automatic trim capability.  
26

27 [0390] In one aspect of the present invention, through GUI display 2622, an operator can  
28 maintain a variable level of control over a UAV, from fully manual to fully autonomous,  
29 with simple user-friendly inputs. For example, if an operator decides to divert a UAV to a  
30 new route, the operator has a plurality of options to select from. The following are examples  
31 of some of the options that an operator has. Those skilled in the art should recognize that  
32 this is not an exhaustive list. In one embodiment, the operator could graphically edit the  
33 existing route on mission situation display 2629 by adding a waypoint or orbit pattern in the  
34 vicinity of a desired target region. Prior to accepting the edited route, the control system  
35 evaluates the revised route against the vehicle performance capability as well as terrain  
36 obstructions. If the route is within acceptable bounds, the control system registers the  
37 modified route and maneuvers the vehicle accordingly. In another embodiment, the operator  
38 could select a park mode on selections pane 2630. After selected, the control system queues  
39 the operator to click the location of and graphical size (via a mouse) the desired orbit pattern  
40 in which the vehicle will fly while "parked" over a desired target. In another embodiment,  
41 the operator can select a manual control mode on selections pane 2630. By selecting RDC  
42 (remote directional command), for example, the control system controls the UAV into a  
43 constant altitude, heading and speed flight until the operator instructs a maneuver. While in  
44 RDC mode, the operator can either pseudo-manually direct the UAV using the control stick  
45 (e.g. joystick) or the operator can program a fixed heading, altitude and speed using the  
46 control options provided in selections pane 2630.

1  
2 [0391] The described Intelligent displays with smart variables represent an effective  
3 approach to actively displaying information for different types of vehicles. However, a  
4 problem can arise when a new vehicle is integrated into the ground control station with a  
5 completely foreign command and control interface. Under these circumstances, the ground  
6 control station is not concerned about displaying data, but is tasked to provide a command  
7 and control interface for the operator to perform the required operations. This conundrum is  
8 the motivation for another embodiment of the present invention, namely, the integration of  
9 vehicle specific panels in the ground control station.

10  
11 [0392] In one embodiment, a generic vehicle class (GVC) is illustratively a software  
12 component that provides a rapid development environment API to add new vehicle classes  
13 and types to the ground control station. The GVC also illustratively serves as a software  
14 construct that allows the inclusion of multiple vehicles within the ground control station  
15 framework. One of the variables in the application is a vector of pointers to a generic vehicle  
16 class. This list is constructed by allocating new specific vehicles and returning a type case to  
17 the base generic vehicle class. When a new vehicle is integrated into the ground control  
18 station, the generic vehicle class provides all of the virtual functions to integrate with system  
19 control components (e.g., to integrate with a map display, a communications package, PCIG  
20 imagery and/or appropriate display windows). An important object in the application  
21 framework is illustratively a pointer to the current vehicle generic class. When the user  
22 switches vehicles, this pointer is updated and all displays grab the appropriate smart  
23 variables from the pointer to the new base class. This is the mechanism by which windows  
24 immediately update to the current vehicle information whenever the user switches vehicles.  
25 The default windows use the pointer to the current vehicle to grab information. In this  
26 manner, if the user switches to a new vehicle with a different set of datalink variables, that  
27 fact is immediately apparent on the display windows.

28  
29 The Examiner particularly failed to even make an attempt to point out the following limitation in  
30 claim 5:

31 whereas the selected phases of the flight of said unmanned aerial vehicle comprise:

32  
33 (a) when said unmanned aerial vehicle is within a selected range of an airport or other  
34 designated location and is below a first specified altitude;

35  
36 (b) when said unmanned aerial vehicle is outside said selected range of an airport or other  
37 designated location and is below a second specified altitude.

38  
39 Again, not only do the Duggan citations fail to support a broadest reasonable interpretation (or  
40 even a broadest possible interpretation) for the Examiner's assertion, they amount to a series of  
41 non sequiturs.

42

43



1 **Claim 6 (Dependent)**

2

3 Claim 6 is a dependent claim, dependent on Claim 5. Margolin has shown that Claim 5 is  
4 nonobvious. Therefore, under **2143.03 All Claim Limitations Must Be Considered**, Claim 6 is  
5 non-obvious.

6

7 **Claim 7 (Dependent)**

8

9 Claim 7 is a dependent claim, dependent on Claim 5. Margolin has shown that Claim 5  
10 is nonobvious. Therefore, under **2143.03 All Claim Limitations Must Be Considered**, Claim 7  
11 is non-obvious.

12

13 **Claim 8 (Independent)**

14

15 As with his rejection of independent claim 5 the Examiner simply cited the following in '724:  
16 *abstract; figs. 1-7; col. 3, lines 8-67; col. 4, lines 1-67; col. 5, lines 1-67*. See Office Action dated  
17 September 1, 2010, pages 6,7 (Evidence Appendix Exhibit 3 at 108) and Office Action dated  
18 February 15, 2011, pages 6,7 (Evidence Appendix Exhibit 6 at 441). Then he asserted that he had  
19 found most of the elements contained therein.

20

21 The three passages cited in '724 (Column 3, lines 8-67; Column 4, lines 1-67; and Column 5,  
22 lines 1-67) form a continuous passage from Column 3, line 8 to Column 5, line 67. This passage  
23 of approximately 1619 words forms the core of the '724 DETAILED DESCRIPTION. The  
24 Examiner also cited all of the drawings and the abstract.

25

26 Breaking the long contiguous passage of approximately 1619 words into three sections is  
27 misleading. By doing this the Examiner shows awareness of his failure to make a prima facie  
28 case for rejection. Or, perhaps it was simply laziness.

29

30 The Examiner did cite Duggan in one of the elements, but only one:

31

32 a ground station controlling an unmanned aerial vehicle (sec. 0352, 00353), wherein during  
33 phases of a flight of an unmanned aerial vehicle (UAV, sec 0318, 0322, 0353) when a  
synthetic vision (sec. 0356, 0365, 0388, 0390) is not used to control said unmanned aerial

1 vehicle said unmanned aerial vehicle is flown using an autonomous control system  
2 (autopilot, sec 0346 to 0350, 0390-0329).

3  
4 As with claim 1 and claim 5, the Duggan references are irrelevant. And again, the Examiner  
5 repeats the mistake of referring to 0390-0329.

6 Duggan:

7 [0352] In one aspect of the present invention, an operator station (also referred to as the  
8 ground control station or GCS) is designed to accommodate command and control of  
9 multiple vehicles or a single vehicle by a single operator. In accordance with one  
10 embodiment, the ground control station is platform independent and implements an  
11 application program interface that provides windowing and communications interfaces (e.g.,  
12 the platform is implemented in Open Source wxWindows API). The underlying operating  
13 system is illustratively masked and enables a developer to code in a high level environment.  
14

15 [0353] In one embodiment, the ground control station incorporates several specialized user  
16 interface concepts designed to effectively support a single operator tasked to control  
17 multiple vehicles. The GCS also illustratively supports manual control and sensor steering  
18 modes. In the manual control mode, the operator can assume control authority of the  
19 vehicles individually from the ground control station at any time in flight. In the sensor  
20 steering mode, a vehicle will autonomously fly in the direction the operator is manually  
21 pointing the on-board imaging sensor (e.g., operator views video output from a digital  
22 camera on a TV interface, computer screen display, etc.). A custom data link is illustratively,  
23 utilized to support a two-way transfer of data between the ground control station and the  
24 UAV's. These design concepts together provide a flexible, multiple vehicle control system.  
25 The details of the concepts are discussed below.  
26

27 [0318] If the pilot chooses a surveillance location outside the total FOV, then the outer loop  
28 guidance will illustratively follow a command-to-LOS mode guide law until the UAV flight  
29 path points toward the target. Once the desired staring-point comes within a minimum range  
30 threshold, the guidance automatically trips into a loiter pattern (either constant-radius or  
31 elliptical) to maintain a station with a single key-click while he/she conducts other activities.  
32 FIGS. 22A & 22B together demonstrate the surveillance-point approach scenario.  
33

34 [0322] In accordance with one aspect of the present invention, sensor-slave mode commands  
35 are generated by an autonomous line-of-sight driven function, in which the command  
36 objectives are generated by the necessities of the function rather than by an operator. For  
37 example, a function designed to command a raster-scan of a particular surveillance area, or a  
38 function designed to scan a long a roadway could be used to generate sensor slave  
39 commands. Another example is a function designed to generate line-of-sight commands for  
40 UAV-to-UAV rendezvous formation flying.  
41

42 [0353] In one embodiment, the ground control station incorporates several specialized user  
43 interface concepts designed to effectively support a single operator tasked to control  
44 multiple vehicles. The GCS also illustratively supports manual control and sensor steering

1 modes. In the manual control mode, the operator can assume control authority of the  
2 vehicles individually from the ground control station at any time in flight. In the sensor  
3 steering mode, a vehicle will autonomously fly in the direction the operator is manually  
4 pointing the on-board imaging sensor (e.g., operator views video output from a digital  
5 camera on a TV interface, computer screen display, etc.). A custom data link is illustratively,  
6 utilized to support a two-way transfer of data between the ground control station and the  
7 UAV's. These design concepts together provide a flexible, multiple vehicle control system.  
8 The details of the concepts are discussed below.

9  
10 [0356] a synthetic vision display

11  
12 [0365] The two video monitors are illustratively used to display real-time data linked camera  
13 imagery from two air vehicles having cameras (of course, fewer, more or none of the  
14 vehicles might have cameras and the number of monitor displays can be altered  
15 accordingly). In accordance with one embodiment, camera imagery is recorded on  
16 videotapes during a mission. In accordance with one embodiment, the two repeater displays  
17 are used to provide redundant views of the GUI and synthetic vision display. The laptop  
18 illustratively serves as a GUI backup in the event that the main GUI fails.

19  
20 [0388] In one aspect of the present invention, synthetic vision display technical approach of  
21 the present invention is based upon integrating advanced simulated visuals, originally  
22 developed for training purposes, into UAV operational systems. In accordance with one  
23 embodiment, the simulated visuals are integrated with data derived from the ground control  
24 station during flight to enable real-time synthetic visuals.

25  
26 [0390] In one aspect of the present invention, through GUI display 2622, an operator can  
27 maintain a variable level of control over a UAV, from fully manual to fully autonomous,  
28 with simple user-friendly inputs. For example, if an operator decides to divert a UAV to a  
29 new route, the operator has a plurality of options to select from. The following are examples  
30 of some of the options that an operator has. Those skilled in the art should recognize that  
31 this is not an exhaustive list. In one embodiment, the operator could graphically edit the  
32 existing route on mission situation display 2629 by adding a waypoint or orbit pattern in the  
33 vicinity of a desired target region. Prior to accepting the edited route, the control system  
34 evaluates the revised route against the vehicle performance capability as well as terrain  
35 obstructions. If the route is within acceptable bounds, the control system registers the  
36 modified route and maneuvers the vehicle accordingly. In another embodiment, the operator  
37 could select a park mode on selections pane 2630. After selected, the control system queues  
38 the operator to click the location of and graphical size (via a mouse) the desired orbit pattern  
39 in which the vehicle will fly while "parked" over a desired target. In another embodiment,  
40 the operator can select a manual control mode on selections pane 2630. By selecting RDC  
41 (remote directional command), for example, the control system controls the UAV into a  
42 constant altitude, heading and speed flight until the operator instructs a maneuver. While in  
43 RDC mode, the operator can either pseudo-manually direct the UAV using the control stick  
44 (e.g. joystick) or the operator can program a fixed heading, altitude and speed using the  
45 control options provided in selections pane 2630.

46

1 [0346] In accordance with one embodiment, an exemplary translation layer implementation  
 2 will now be provided. After the guidance algorithms execute, the outputs are translated to  
 3 the native vehicle autopilot commands. The equations below provide example kinematic  
 4 translations from the guidance acceleration commands to native vehicle autopilot  
 5 commands. These equations demonstrate the principal that vehicle motion is activated  
 6 through acceleration. The methods that various vehicles employ to generate acceleration are  
 7 numerous (bank angle autopilot, acceleration autopilot, heading control autopilot, altitude  
 8 control autopilot, etc). Since the control algorithms described herein generate acceleration  
 9 commands that can be kinematically translated into any of these native autopilot commands,  
 10 the guidance algorithms truly provide a generalized library of control laws that can control  
 11 any vehicle through that vehicle's native atomic functions. Ubiquitous acceleration control  
 12 techniques enable VACS to synthesize control commands for any vehicle, including air,  
 13 ground, or sea-based.  $a_v =$  vertical plane acceleration command  $a_h =$  horizontal plane  
 14 acceleration command  $\theta = \tan^{-1}(a_h/a_v) =$  bank angle command  $T = a_v^2 + a_h^2 =$  total  
 15 body acceleration command  $\dot{\theta} = a_h/V =$  turn rate command  $i = i - 1 + \dot{\theta} =$  heading command  
 16  $\dot{\theta} = (a_v - g)/V =$  flight path rate command  $i = i - 1 + \dot{\theta} =$  flight path angle command  $h \dot{\theta} = V$   
 17  $\sin(\theta) =$  climb rate command  $h \dot{i} = h \dot{\theta} = 1 + h \dot{\theta} =$  altitude command Eq. 57

18  
 19 [0347] Additional functionality that can be enabled in a translation layer is means for  
 20 discouraging or preventing an operator (e.g., the human or non-human operator interfacing  
 21 the VACS architecture) from overdriving, stalling, or spinning the vehicle frame. This being  
 22 said, limiting algorithms can also be employed in the guidance or autopilot functions.

23  
 24 [0348] X. Autopilot

25  
 26 [0349] As has been addressed, the present invention is not limited to, and does not require, a  
 27 particular autopilot system. The control system and architecture embodiments of the present  
 28 invention can be adapted to accommodate virtually any autopilot system.

29  
 30 [0350] For the purpose of providing an example, an illustrative suitable autopilot software  
 31 system will now be described. The illustrative autopilot system incorporates a three-axis  
 32 design (pitch and yaw with an attitude control loop in the roll axis) for vehicle stabilization  
 33 and guidance command tracking. The autopilot software design incorporates flight control  
 34 techniques, which allow vehicle control algorithms to dynamically adjust airframe  
 35 stabilization parameters in real-time during flight. The flight computer is programmed  
 36 directly with the airframe physical properties, so that it can automatically adjust its settings  
 37 with changes in airframe configuration, aerodynamic properties, and/or flight state. This  
 38 provides for a simple and versatile design, and possesses the critical flexibility needed when  
 39 adjustments to the airframe configuration become necessary. The three-loop design includes  
 40 angular rate feedback for stability augmentation, attitude feedback for closed-loop stiffness,  
 41 and acceleration feedback for command tracking. In addition, an integral controller in the  
 42 forward loop illustratively provides enhanced command tracking, low frequency disturbance  
 43 rejection and an automatic trim capability.

44  
 45 [0390] In one aspect of the present invention, through GUI display 2622, an operator can  
 46 maintain a variable level of control over a UAV, from fully manual to fully autonomous,

1 with simple user-friendly inputs. For example, if an operator decides to divert a UAV to a  
2 new route, the operator has a plurality of options to select from. The following are examples  
3 of some of the options that an operator has. Those skilled in the art should recognize that  
4 this is not an exhaustive list. In one embodiment, the operator could graphically edit the  
5 existing route on mission situation display 2629 by adding a waypoint or orbit pattern in the  
6 vicinity of a desired target region. Prior to accepting the edited route, the control system  
7 evaluates the revised route against the vehicle performance capability as well as terrain  
8 obstructions. If the route is within acceptable bounds, the control system registers the  
9 modified route and maneuvers the vehicle accordingly. In another embodiment, the operator  
10 could select a park mode on selections pane 2630. After selected, the control system queues  
11 the operator to click the location of and graphical size (via a mouse) the desired orbit pattern  
12 in which the vehicle will fly while "parked" over a desired target. In another embodiment,  
13 the operator can select a manual control mode on selections pane 2630. By selecting RDC  
14 (remote directional command), for example, the control system controls the UAV into a  
15 constant altitude, heading and speed flight until the operator instructs a maneuver. While in  
16 RDC mode, the operator can either pseudo-manually direct the UAV using the control stick  
17 (e.g. joystick) or the operator can program a fixed heading, altitude and speed using the  
18 control options provided in selections pane 2630.

19  
20 [0391] The described Intelligent displays with smart variables represent an effective  
21 approach to actively displaying information for different types of vehicles. However, a  
22 problem can arise when a new vehicle is integrated into the ground control station with a  
23 completely foreign command and control interface. Under these circumstances, the ground  
24 control station is not concerned about displaying data, but is tasked to provide a command  
25 and control interface for the operator to perform the required operations. This conundrum is  
26 the motivation for another embodiment of the present invention, namely, the integration of  
27 vehicle specific panels in the ground control station.

28  
29 [0392] In one embodiment, a generic vehicle class (GVC) is illustratively a software  
30 component that provides a rapid development environment API to add new vehicle classes  
31 and types to the ground control station. The GVC also illustratively serves as a software  
32 construct that allows the inclusion of multiple vehicles within the ground control station  
33 framework. One of the variables in the application is a vector of pointers to a generic vehicle  
34 class. This list is constructed by allocating new specific vehicles and returning a type case to  
35 the base generic vehicle class. When a new vehicle is integrated into the ground control  
36 station, the generic vehicle class provides all of the virtual functions to integrate with system  
37 control components (e.g., to integrate with a map display, a communications package, PCIG  
38 imagery and/or appropriate display windows). An important object in the application  
39 framework is illustratively a pointer to the current vehicle generic class. When the user  
40 switches vehicles, this pointer is updated and all displays grab the appropriate smart  
41 variables from the pointer to the new base class. This is the mechanism by which windows  
42 immediately update to the current vehicle information whenever the user switches vehicles.  
43 The default windows use the pointer to the current vehicle to grab information. In this  
44 manner, if the user switches to a new vehicle with a different set of datalink variables, that  
45 fact is immediately apparent on the display windows.

1 The Examiner particularly failed to even make an attempt to point out the following limitation in  
2 claim 8:

3 whereas the selected phases of the flight of said unmanned aerial vehicle comprise:

4  
5 (a) when said unmanned aerial vehicle is within a selected range of an airport or other  
6 designated location and is below a first specified altitude;

7  
8 (b) when said unmanned aerial vehicle is outside said selected range of an airport or other  
9 designated location and is below a second specified altitude.

10  
11 Again, not only do the Duggan citations fail to support a broadest reasonable interpretation (or  
12 even a broadest possible interpretation) for the Examiner's assertion, they amount to a series of  
13 non sequiturs.

14

15 **Claim 9 (Dependent)**

16

17 Claim 9 is a dependent claim, dependent on Claim 8. Margolin has shown that Claim 8 is  
18 nonobvious. Therefore, under **2143.03 All Claim Limitations Must Be Considered**, Claim 9 is  
19 non-obvious.

20

21 **Claim 10 (Dependent)**

22

23 Claim 10 is a dependent claim, dependent on Claim 8. Margolin has shown that Claim 8 is  
24 nonobvious. Therefore, under **2143.03 All Claim Limitations Must Be Considered**, Claim 10  
25 is non-obvious.

26

27 **Claim 11 (Dependent)**

28

29 Claim 11 is a dependent claim, dependent on Claim 8. Margolin has shown that Claim 8 is  
30 nonobvious. Therefore, under **2143.03 All Claim Limitations Must Be Considered**, Claim 11  
31 is non-obvious.

32

1 **Claim 12 (Independent)**

2

3 As with the Examiner's rejection of claim 5 and claim 8, in his rejection of claim 12 he simply  
 4 cited the following from '724: *abstract; figs. 1-7; col. 3, lines 8-67; col. 4, lines 1-67; col. 5, lines*  
 5 *1-67*. See Office Action dated September 1, 2010, pages 8,9 (Evidence Appendix Exhibit 3 at  
 6 110) and Office Action dated February 15, 2011, pages 8,9 (Evidence Appendix Exhibit 6 at  
 7 443).

8

9 The three passages cited in '724 (Column 3, lines 8-67; Column 4, lines 1-67; and Column 5,  
 10 lines 1-67) form a continuous passage from Column 3, line 8 to Column 5, line 67. This passage  
 11 of approximately 1619 words forms the core of the '724 DETAILED DESCRIPTION. The  
 12 Examiner also cited all of the drawings and the abstract.

13

14 Breaking the long contiguous passage of approximately 1619 words into three sections is  
 15 misleading. By doing this the Examiner shows awareness of his failure to make a prima facie  
 16 case for rejection. Or, perhaps it was simply laziness.

17

18 The Examiner did cite Duggan in one of the elements, but only one:

19 a ground station controlling an unmanned aerial vehicle (sec. 0352, 00353), wherein during  
 20 phases of a flight of an unmanned aerial vehicle (UAV, sec 0318, 0322, 0353) when a  
 21 synthetic vision (sec. 0356, 0365, 0388, 0390) is not used to control said unmanned aerial  
 22 vehicle said unmanned aerial vehicle is flown using an autonomous control system  
 23 (autopilot, sec 0346 to 0350, 0390-0329).

24

25 As with the rejection of claim 1, claim 5, and claim 8 the Duggan references are irrelevant. And  
 26 again, the Examiner repeats the mistake of referring to 0390-0329.

27 Duggan:

28 [0352] In one aspect of the present invention, an operator station (also referred to as the  
 29 ground control station or GCS) is designed to accommodate command and control of  
 30 multiple vehicles or a single vehicle by a single operator. In accordance with one  
 31 embodiment, the ground control station is platform independent and implements an  
 32 application program interface that provides windowing and communications interfaces (e.g.,  
 33 the platform is implemented in Open Source wxWindows API). The underlying operating  
 34 system is illustratively masked and enables a developer to code in a high level environment.

35

1 [0353] In one embodiment, the ground control station incorporates several specialized user  
2 interface concepts designed to effectively support a single operator tasked to control  
3 multiple vehicles. The GCS also illustratively supports manual control and sensor steering  
4 modes. In the manual control mode, the operator can assume control authority of the  
5 vehicles individually from the ground control station at any time in flight. In the sensor  
6 steering mode, a vehicle will autonomously fly in the direction the operator is manually  
7 pointing the on-board imaging sensor (e.g., operator views video output from a digital  
8 camera on a TV interface, computer screen display, etc.). A custom data link is illustratively,  
9 utilized to support a two-way transfer of data between the ground control station and the  
10 UAV's. These design concepts together provide a flexible, multiple vehicle control system.  
11 The details of the concepts are discussed below.  
12

13 [0318] If the pilot chooses a surveillance location outside the total FOV, then the outer loop  
14 guidance will illustratively follow a command-to-LOS mode guide law until the UAV flight  
15 path points toward the target. Once the desired staring-point comes within a minimum range  
16 threshold, the guidance automatically trips into a loiter pattern (either constant-radius or  
17 elliptical) to maintain a station with a single key-click while he/she conducts other activities.  
18 FIGS. 22A & 22B together demonstrate the surveillance-point approach scenario.  
19

20 [0322] In accordance with one aspect of the present invention, sensor-slave mode commands  
21 are generated by an autonomous line-of-sight driven function, in which the command  
22 objectives are generated by the necessities of the function rather than by an operator. For  
23 example, a function designed to command a raster-scan of a particular surveillance area, or a  
24 function designed to scan a long a roadway could be used to generate sensor slave  
25 commands. Another example is a function designed to generate line-of-sight commands for  
26 UAV-to-UAV rendezvous formation flying.  
27

28 [0353] In one embodiment, the ground control station incorporates several specialized user  
29 interface concepts designed to effectively support a single operator tasked to control  
30 multiple vehicles. The GCS also illustratively supports manual control and sensor steering  
31 modes. In the manual control mode, the operator can assume control authority of the  
32 vehicles individually from the ground control station at any time in flight. In the sensor  
33 steering mode, a vehicle will autonomously fly in the direction the operator is manually  
34 pointing the on-board imaging sensor (e.g., operator views video output from a digital  
35 camera on a TV interface, computer screen display, etc.). A custom data link is illustratively,  
36 utilized to support a two-way transfer of data between the ground control station and the  
37 UAV's. These design concepts together provide a flexible, multiple vehicle control system.  
38 The details of the concepts are discussed below.  
39

40 [0356] a synthetic vision display  
41

42 [0365] The two video monitors are illustratively used to display real-time data linked camera  
43 imagery from two air vehicles having cameras (of course, fewer, more or none of the  
44 vehicles might have cameras and the number of monitor displays can be altered  
45 accordingly). In accordance with one embodiment, camera imagery is recorded on  
46 videotapes during a mission. In accordance with one embodiment, the two repeater displays



1 are used to provide redundant views of the GUI and synthetic vision display. The laptop  
 2 illustratively serves as a GUI backup in the event that the main GUI fails.

3  
 4 [0388] In one aspect of the present invention, synthetic vision display technical approach of  
 5 the present invention is based upon integrating advanced simulated visuals, originally  
 6 developed for training purposes, into UAV operational systems. In accordance with one  
 7 embodiment, the simulated visuals are integrated with data derived from the ground control  
 8 station during flight to enable real-time synthetic visuals.

9  
 10 [0390] In one aspect of the present invention, through GUI display 2622, an operator can  
 11 maintain a variable level of control over a UAV, from fully manual to fully autonomous,  
 12 with simple user-friendly inputs. For example, if an operator decides to divert a UAV to a  
 13 new route, the operator has a plurality of options to select from. The following are examples  
 14 of some of the options that an operator has. Those skilled in the art should recognize that  
 15 this is not an exhaustive list. In one embodiment, the operator could graphically edit the  
 16 existing route on mission situation display 2629 by adding a waypoint or orbit pattern in the  
 17 vicinity of a desired target region. Prior to accepting the edited route, the control system  
 18 evaluates the revised route against the vehicle performance capability as well as terrain  
 19 obstructions. If the route is within acceptable bounds, the control system registers the  
 20 modified route and maneuvers the vehicle accordingly. In another embodiment, the operator  
 21 could select a park mode on selections pane 2630. After selected, the control system queues  
 22 the operator to click the location of and graphical size (via a mouse) the desired orbit pattern  
 23 in which the vehicle will fly while "parked" over a desired target. In another embodiment,  
 24 the operator can select a manual control mode on selections pane 2630. By selecting RDC  
 25 (remote directional command), for example, the control system controls the UAV into a  
 26 constant altitude, heading and speed flight until the operator instructs a maneuver. While in  
 27 RDC mode, the operator can either pseudo-manually direct the UAV using the control stick  
 28 (e.g. joystick) or the operator can program a fixed heading, altitude and speed using the  
 29 control options provided in selections pane 2630.

30  
 31 [0346] In accordance with one embodiment, an exemplary translation layer implementation  
 32 will now be provided. After the guidance algorithms execute, the outputs are translated to  
 33 the native vehicle autopilot commands. The equations below provide example kinematic  
 34 translations from the guidance acceleration commands to native vehicle autopilot  
 35 commands. These equations demonstrate the principal that vehicle motion is activated  
 36 through acceleration. The methods that various vehicles employ to generate acceleration are  
 37 numerous (bank angle autopilot, acceleration autopilot, heading control autopilot, altitude  
 38 control autopilot, etc). Since the control algorithms described herein generate acceleration  
 39 commands that can be kinematically translated into any of these native autopilot commands,  
 40 the guidance algorithms truly provide a generalized library of control laws that can control  
 41 any vehicle through that vehicle's native atomic functions. Ubiquitous acceleration control  
 42 techniques enable VACS to synthesize control commands for any vehicle, including air,  
 43 ground, or sea-based. 35  $a_v$  = vertical plane acceleration command  $a_h$  = horizontal plane  
 44 acceleration command  $\tan^{-1} ( a_h / a_v )$  = bank angle command  $a_T = a_v^2 + a_h^2$  = total  
 45 body acceleration command  $\dot{\theta} = a_h / V$  = turn rate command  $i = i - 1 + \dot{\theta} \cdot t$  = heading command

1  $\dot{v} = (a_v - g) V = \text{flight path rate command}$   $\dot{\gamma} = \dot{\gamma} - 1 + \dot{\gamma} = \text{flight path angle command}$   $\dot{h} = V$   
 2  $\sin(\gamma) = \text{climb rate command}$   $\dot{h}_i = \dot{h}_i = 1 + \dot{h}_i = \text{altitude command}$  Eq. 57

3  
 4 [0347] Additional functionality that can be enabled in a translation layer is means for  
 5 discouraging or preventing an operator (e.g., the human or non-human operator interfacing  
 6 the VACS architecture) from overdriving, stalling, or spinning the vehicle frame. This being  
 7 said, limiting algorithms can also be employed in the guidance or autopilot functions.

8  
 9 [0348] X. Autopilot

10  
 11 [0349] As has been addressed, the present invention is not limited to, and does not require, a  
 12 particular autopilot system. The control system and architecture embodiments of the present  
 13 invention can be adapted to accommodate virtually any autopilot system.

14  
 15 [0350] For the purpose of providing an example, an illustrative suitable autopilot software  
 16 system will now be described. The illustrative autopilot system incorporates a three-axis  
 17 design (pitch and yaw with an attitude control loop in the roll axis) for vehicle stabilization  
 18 and guidance command tracking. The autopilot software design incorporates flight control  
 19 techniques, which allow vehicle control algorithms to dynamically adjust airframe  
 20 stabilization parameters in real-time during flight. The flight computer is programmed  
 21 directly with the airframe physical properties, so that it can automatically adjust its settings  
 22 with changes in airframe configuration, aerodynamic properties, and/or flight state. This  
 23 provides for a simple and versatile design, and possesses the critical flexibility needed when  
 24 adjustments to the airframe configuration become necessary. The three-loop design includes  
 25 angular rate feedback for stability augmentation, attitude feedback for closed-loop stiffness,  
 26 and acceleration feedback for command tracking. In addition, an integral controller in the  
 27 forward loop illustratively provides enhanced command tracking, low frequency disturbance  
 28 rejection and an automatic trim capability.

29  
 30 [0390] In one aspect of the present invention, through GUI display 2622, an operator can  
 31 maintain a variable level of control over a UAV, from fully manual to fully autonomous,  
 32 with simple user-friendly inputs. For example, if an operator decides to divert a UAV to a  
 33 new route, the operator has a plurality of options to select from. The following are examples  
 34 of some of the options that an operator has. Those skilled in the art should recognize that  
 35 this is not an exhaustive list. In one embodiment, the operator could graphically edit the  
 36 existing route on mission situation display 2629 by adding a waypoint or orbit pattern in the  
 37 vicinity of a desired target region. Prior to accepting the edited route, the control system  
 38 evaluates the revised route against the vehicle performance capability as well as terrain  
 39 obstructions. If the route is within acceptable bounds, the control system registers the  
 40 modified route and maneuvers the vehicle accordingly. In another embodiment, the operator  
 41 could select a park mode on selections pane 2630. After selected, the control system queues  
 42 the operator to click the location of and graphical size (via a mouse) the desired orbit pattern  
 43 in which the vehicle will fly while "parked" over a desired target. In another embodiment,  
 44 the operator can select a manual control mode on selections pane 2630. By selecting RDC  
 45 (remote directional command), for example, the control system controls the UAV into a  
 46 constant altitude, heading and speed flight until the operator instructs a maneuver. While in

1 RDC mode, the operator can either pseudo-manually direct the UAV using the control stick  
2 (e.g. joystick) or the operator can program a fixed heading, altitude and speed using the  
3 control options provided in selections pane 2630.  
4

5 [0391] The described Intelligent displays with smart variables represent an effective  
6 approach to actively displaying information for different types of vehicles. However, a  
7 problem can arise when a new vehicle is integrated into the ground control station with a  
8 completely foreign command and control interface. Under these circumstances, the ground  
9 control station is not concerned about displaying data, but is tasked to provide a command  
10 and control interface for the operator to perform the required operations. This conundrum is  
11 the motivation for another embodiment of the present invention, namely, the integration of  
12 vehicle specific panels in the ground control station.  
13

14 [0392] In one embodiment, a generic vehicle class (GVC) is illustratively a software  
15 component that provides a rapid development environment API to add new vehicle classes  
16 and types to the ground control station. The GVC also illustratively serves as a software  
17 construct that allows the inclusion of multiple vehicles within the ground control station  
18 framework. One of the variables in the application is a vector of pointers to a generic vehicle  
19 class. This list is constructed by allocating new specific vehicles and returning a type case to  
20 the base generic vehicle class. When a new vehicle is integrated into the ground control  
21 station, the generic vehicle class provides all of the virtual functions to integrate with system  
22 control components (e.g., to integrate with a map display, a communications package, PCIG  
23 imagery and/or appropriate display windows). An important object in the application  
24 framework is illustratively a pointer to the current vehicle generic class. When the user  
25 switches vehicles, this pointer is updated and all displays grab the appropriate smart  
26 variables from the pointer to the new base class. This is the mechanism by which windows  
27 immediately update to the current vehicle information whenever the user switches vehicles.  
28 The default windows use the pointer to the current vehicle to grab information. In this  
29 manner, if the user switches to a new vehicle with a different set of datalink variables, that  
30 fact is immediately apparent on the display windows.  
31

32 The Examiner particularly failed to even make an attempt to point out the following limitation in  
33 claim 12:

34 whereas the selected phases of the flight of said unmanned aerial vehicle comprise:

35  
36 (a) when said unmanned aerial vehicle is within a selected range of an airport or other  
37 designated location and is below a first specified altitude;

38  
39 (b) when said unmanned aerial vehicle is outside said selected range of an airport or other  
40 designated location and is below a second specified altitude.  
41

42 Again, not only do the Duggan citations fail to support a broadest reasonable interpretation (or  
43 even a broadest possible interpretation) for the Examiner's assertion, they amount to a series of  
44 non sequiturs.

1 **Claim 13 (Dependent)**

2

3 Claim 13 is a dependent claim, dependent on Claim 12. Margolin has shown that Claim 12 is  
4 nonobvious. Therefore, under **2143.03 All Claim Limitations Must Be Considered**, Claim 13  
5 is non-obvious.

6

7 **Claim 14 (Dependent)**

8

9 Claim 14 is a dependent claim, dependent on Claim 12. Margolin has shown that Claim 12 is  
10 nonobvious. Therefore, under **2143.03 All Claim Limitations Must Be Considered**, Claim 14  
11 is non-obvious.

12

13

14 The remaining grounds come from the section **Response to Arguments** on page 10 in the Office  
15 Action of February 15, 2011 (See Evidence Appendix Exhibit 6 at 445). By making the Office  
16 Action final the Examiner denied Margolin the opportunity to respond to the Examiner's new  
17 arguments. In the telephone interview with the Examiner on or about March 2, 2011 Margolin  
18 asked the Examiner to withdraw making the Office Action final so Margolin could respond. The  
19 Examiner refused. (See Evidence Appendix Exhibit 7 at 452.) After a telephone interview with  
20 the Examiner's SPE on or about March 22, 2011 the Examiner's SPE distinguished the section in  
21 the Office Action of February 15, 2011 "Response to Arguments" with the Formal Rejection in  
22 "Claim Rejections" and stated that "Response to Arguments" was not subject to Rule 706.07(a).  
23 (See Evidence Appendix Exhibit 8 at 457.)

24

25 The Examiner's **Response to Arguments** contains arguments that he could have made in the  
26 Office Action of September 1, 2010. If he had done so, Margolin would have had the opportunity  
27 to refute them and produce new evidence. The Examiner denied Margolin this opportunity.

28

29 If, as the Examiner's SPE stated, the Examiner's **Response to Arguments** is not part of the  
30 Formal Rejection, then the Board of Appeals should either order that the **Response to**  
31 **Arguments** be stricken from the Office Action or they should simply ignore them. If not, then the  
32 Board of Appeals should consider the following.

1 **Ground B.**

2  
3 Whether Margolin had a duty to define the term "civilian airspace" or whether he was entitled to  
4 use the common meaning of the term.

5  
6 In the Office Action of February 15, 2011 on page 10 (Evidence Appendix Exhibit 6 at 445) the  
7 Examiner stated:

8 Applicant further argues that the prior art do not disclose flying an unmanned aerial vehicle  
9 (i.e. an aircraft) in civilian airspace. The examiner does not acquiesce to applicant's remarks.  
10 The prior art clearly shows flying an unmanned aerial vehicle (i.e. an aircraft) in civilian  
11 airspace since the air space in which the vehicle is flown is not restricted. **As further noted**  
12 **applicant fails to provide a particular meaning attached to "civilian airspace".**  
13

14 {Emphasis added}

15  
16 While an Applicant is permitted to be his own lexicographer, he is not required to be one. He  
17 may rely on the common meanings of words. From MPEP § 2111.01 **Plain Meaning [R-5] -**

18 **2100 Patentability:**

19 I. THE WORDS OF A CLAIM MUST BE GIVEN THEIR "PLAIN MEANING"  
20 UNLESS **\*\*>SUCH MEANING IS INCONSISTENT WITH<** THE SPECIFICATION

21  
22 **\*\*>Although<** claims of issued patents are interpreted in light of the specification,  
23 prosecution history, prior art and other claims, this is not the mode of claim interpretation to  
24 be applied during examination. During examination, the claims must be interpreted as  
25 broadly as their terms reasonably allow. *In re American Academy of Science Tech Center*,  
26 367 F.3d 1359, 1369, 70 USPQ2d 1827, 1834 (Fed. Cir. 2004) (The USPTO uses a different  
27 standard for construing claims than that used by district courts; during examination the  
28 USPTO must give claims their broadest reasonable interpretation **>in light of the**  
29 **specification<.** **This means that the words of the claim must be given their plain**  
30 **meaning unless **\*\*>the plain meaning is inconsistent with<** the specification.** *In re Zletz*,  
31 893 F.2d 319, 321, 13 USPQ2d 1320, 1322 (Fed. Cir. 1989) (discussed below); *Chef*  
32 *America, Inc. v. Lamb-Weston, Inc.*, 358 F.3d 1371, 1372, 69 USPQ2d 1857 (Fed. Cir.  
33 2004) (Ordinary, simple English words whose meaning is clear and unquestionable, absent  
34 any indication that their use in a particular context changes their meaning, are construed to  
35 mean exactly what they say. Thus, "heating the resulting batter-coated dough to a  
36 temperature in the range of about 400°F to 850°F" required heating the dough, rather than  
37 the air inside an oven, to the specified temperature.). **\*\***  
38

39 {Emphasis added}

40

1 Part II does not apply here:

2 II. IT IS IMPROPER TO IMPORT CLAIM LIMITATIONS FROM THE  
3 SPECIFICATION  
4

5 Part III does:

6 III. < "PLAIN MEANING" REFERS TO THE ORDINARY AND CUSTOMARY  
7 MEAN-ING GIVEN TO THE TERM BY THOSE OF ORDINARY SKILL IN THE ART

8 **"[T]he ordinary and customary meaning of a claim term is the meaning that the term**  
9 **would have to a person of ordinary skill in the art in question at the time of the**  
10 **invention, i.e., as of the effective filing date of the patent application."** *Phillips v. AWH*  
11 *Corp.*, \*415 F.3d 1303, 1313<, 75 USPQ2d 1321>, 1326< (Fed. Cir. 2005) (*en banc*).  
12 *Sunrize Roots Enter. Co. v. SRAM Corp.*, 336 F.3d 1298, 1302, 67 USPQ2d 1438, 1441  
13 (Fed. Cir. 2003); *Brookhill-Wilk 1, LLC v. Intuitive Surgical, Inc.*, 334 F.3d 1294, 1298 67  
14 **USPQ2d 1132, 1136 (Fed. Cir. 2003)**("In the absence of an express intent to impart a  
15 **novel meaning to the claim terms, the words are presumed to take on the ordinary and**  
16 **customary meanings attributed to them by those of ordinary skill in the art.>"). It is the  
17 use of the words in the context of the written description and customarily by those skilled in  
18 the relevant art that accurately reflects both the "ordinary" and the "customary" meaning of  
19 the terms in the claims. *Ferguson Beauregard/Logic Controls v. Mega Systems*, 350 F.3d  
20 1327, 1338, 69 USPQ2d 1001, 1009 (Fed. Cir. 2003) (Dictionary definitions were used to  
21 determine the ordinary and customary meaning of the words "normal" and "predetermine" to  
22 those skilled in the art. In construing claim terms, the general meanings gleaned from  
23 reference sources, such as dictionaries, must always be compared against the use of the  
24 terms in context, and the intrinsic record must always be consulted to identify which of the  
25 different possible dictionary meanings is most consistent with the use of the words by the  
26 inventor.); *ACTV, Inc. v. The Walt Disney Company*, 346 F.3d 1082, 1092, 68 USPQ2d  
27 1516, 1524 (Fed. Cir. 2003) (Since there was no >express< definition given for the term  
28 "URL" in the specification, the term should be given its broadest reasonable interpretation  
29 >consistent with the intrinsic record< and take on the ordinary and customary meaning  
30 attributed to it by those of ordinary skill in the art; thus, the term "URL" was held to  
31 encompass both relative and absolute URLs.); and *E-Pass Technologies, Inc. v. 3Com*  
32 *Corporation*, 343 F.3d 1364, 1368, 67 USPQ2d 1947, 1949 (Fed. Cir. 2003) (Where no  
33 explicit definition for the term "electronic multi-function card" was given in the  
34 specification, this term should be given its ordinary meaning and broadest reasonable  
35 interpretation; the term should not be limited to the industry standard definition of credit  
36 card where there is no suggestion that this definition applies to the electronic multi-function  
37 card as claimed, and should not be limited to preferred embodiments in the specification.).**

38 **The ordinary and customary meaning of a term may be evidenced by a variety of**  
39 **sources, >including "the words of the claims themselves, the remainder of the**  
40 **specification, the prosecution history, and extrinsic evidence concerning relevant**  
41 **scientific principles, the meaning of technical terms, and the state of the art."** < *Phillips*  
42 *v. AWH Corp.*, \*415 F.3d at 1314<, 75 USPQ2d \*\*>at 1327.< If extrinsic reference

1 sources, such as dictionaries, evidence more than one definition for the term, the intrinsic  
 2 record must be consulted to identify which of the different possible definitions is most  
 3 consistent with applicant's use of the terms. *Brookhill-Wilk 1*, 334 F. 3d at 1300, 67 USPQ2d  
 4 at 1137; see also *Renishaw PLC v. Marposs Societa" per Azioni*, 158 F.3d 1243, 1250,  
 5 48 USPQ2d 1117, 1122 (Fed. Cir. 1998) ("Where there are several common meanings for a  
 6 claim term, the patent disclosure serves to point away from the improper meanings and  
 7 toward the proper meanings.") and *Vitronics Corp. v. Conception Inc.*, 90 F.3d 1576,  
 8 1583, 39 USPQ2d 1573, 1577 (Fed. Cir. 1996) (construing the term "solder reflow  
 9 temperature" to mean "peak reflow temperature" of solder rather than the "liquidus  
 10 temperature" of solder in order to remain consistent with the specification.). If more than  
 11 one extrinsic definition is consistent with the use of the words in the intrinsic record, the  
 12 claim terms may be construed to encompass all consistent meanings. \*\* See \*>e.g.,<  
 13 *Rexnord Corp. v. Laitram Corp.*, 274 F.3d 1336, 1342, 60 USPQ2d 1851, 1854 (Fed. Cir.  
 14 2001)(explaining the court's analytical process for determining the meaning of disputed  
 15 claim terms); *Toro Co. v. White Consol. Indus., Inc.*, **199 F.3d 1295, 1299, 53 USPQ2d**  
 16 **1065, 1067 (Fed. Cir. 1999)**("[W]ords in patent claims are given their ordinary  
 17 **meaning in the usage of the field of the invention, unless the text of the patent makes**  
 18 **clear that a word was used with a special meaning.**"). Compare *MSM Investments Co. v.*  
 19 *Carolwood Corp.*, 259 F.3d 1335, 1339-40, 59 USPQ2d 1856, 1859-60 (Fed. Cir. 2001)  
 20 (Claims directed to a method of feeding an animal a beneficial amount of  
 21 methylsulfonylmethane (MSM) to enhance the animal's diet were held anticipated by prior  
 22 oral administration of MSM to human patients to relieve pain. Although the ordinary  
 23 meaning of "feeding" is limited to provision of food or nourishment, the broad definition of  
 24 "food" in the written description warranted finding that the claimed method encompasses the  
 25 use of MSM for both nutritional and pharmacological purposes.); and *Rapoport v. Dement*,  
 26 254 F.3d 1053, 1059-60, 59 USPQ2d 1215, 1219-20 (Fed. Cir. 2001) (Both intrinsic  
 27 evidence and the plain meaning of the term "method for treatment of sleep apneas"  
 28 supported construction of the term as being limited to treatment of the underlying sleep  
 29 apnea disorder itself, and not encompassing treatment of anxiety and other secondary  
 30 symptoms related to sleep apnea.).

31 {Emphasis added}

32  
 33 The term "civilian airspace" is commonly used in the aerospace community.

34  
 35 The reference **Sensing Requirements for Unmanned Air Vehicles**, AFRL's Air Vehicles  
 36 Directorate, Control Sciences Division, Systems Development Branch, Wright-Patterson AFB  
 37 OH, June 2004, was filed with the application. (See Evidence Appendix Exhibit 9 at 462 and  
 38 Exhibit 10 at 465.)

39  
 40 The very first paragraph refers to "civilian airspace."

1 Engineers from the Air Vehicles Directorate transferred unmanned air vehicle (UAV)  
2 sensing system requirements for airspace operations to civilian UAV users and developers.  
3 These requirements represent design goals on which to base future sensing subsystem  
4 designs, filling an omission in UAV technology planning. **Directorate engineers are**  
5 **continuing to develop the technologies that will enable future UAVs to coexist with**  
6 **manned aircraft in both military and civilian airspace.** Incorporating these requirements  
7 will ensure that engineers design future UAVs to detect possible conflicts, such as midair  
8 collisions or runway incursions, and take action to avoid them.

9  
10 {Emphasis added}

11  
12 Here it is again in the third paragraph.

13 With this goal in mind, directorate engineers worked with Northrop Grumman Corporation  
14 (NGC) engineers to establish, iterate, and finalize sensing system performance requirements  
15 for the broad range of future Air Force missions. **During this collaborative process,**  
16 **directorate engineers noted that many mission elements were similar to civilian**  
17 **airspace operations tasks,** and that the requirements they were developing were directly  
18 applicable to civilian UAV technology.

19  
20 {Emphasis added}

21  
22 Thus, there is civilian airspace and there is military airspace.

23  
24 This is consistent with the remarks made by FAA Administrator Babbitt in a speech he gave  
25 November 18, 2009. (See Evidence Appendix Exhibit 14 at 498).

26  
27 In the second paragraph he says:

28 **So if we are direct with ourselves here, as of today, unmanned aircraft systems are not**  
29 **ready for seamless or routine use yet in civilian airspace.** The idea of pilots flying  
30 remotely has been around for a long time. And it is, I truly believe, the way of the future.  
31 But where we are, on numerous fronts, they're not ready for open access to the **NAS** and we  
32 can't give you the thumbs up.

33  
34 Indeed, he equates "civilian airspace" with the NAS. (NAS is the "National Airspace System.")

35  
36 He does it again in the next paragraph.

37 And you know that I'm not telling you anything that your technical folks aren't already  
38 telling you. While the UAS is undoubtedly the way of the future, my concern must be on  
39 today, and right now, the era of the unmanned aircraft system in **civilian airspace** is just not  
40 here yet. Much as we'd all wish the case were different, the level of technical maturity isn't  
41 where it needs to be for full operation in the **NAS**.



1 {Emphasis added}

2

3 And in paragraph 11:

4 That kind of scenario notwithstanding, I think unmanned aircraft systems are here to stay. In  
5 FY-09, there were about 20,000 flights in **civilian airspace** for a total of over 2,500 hours.

6 And the number of operations that have been granted has more than tripled since 2007. But  
7 in order for us to get to the place where the UAS can become a viable, accepted part of the  
8 **national airspace system**, we have to make sure that sense-and-avoid is more than a given  
9 — it must be a guarantee.

10

11 Thus the term “civilian airspace” is commonly used in the aerospace community (which includes  
12 the FAA and the Air Force) and Margolin is entitled to its commonly used (and plain) meaning.

13

14 Margolin used the term “civilian airspace” because the military controls its own airspace (such as  
15 around its bases) and makes its own rules. The Margolin application documents the difficulties in  
16 flying UAVS in civilian airspace in BACKGROUND OF THE INVENTION - Current Practice.

17 (See page 2, line 33 - page 4, line 21.) That is why Margolin’s invention is directed to safely  
18 flying UAVs in civilian airspace.

19

20 The significance of the Examiner’s strategy in denying Margolin the common use of the term  
21 can be found in *Ex parte MAURICE GIVENS* Appeal 2009-003414, BPAI Informative Decision,  
22 Decided: August 6, 2009. (See Evidence Appendix Exhibit 13 at 493.)

23

24 In *Givens* (Evidence Appendix Exhibit 13 at 494):

25 The Examiner rejected claims 1-15 under 35 U.S.C. § 102(e) based upon the teachings of  
26 Lin.

27

28 The only contention is whether Lin teaches a sub-band spectral subtractive routine  
29 external to an LMS-based adaptive filter (App. Br. 7-9; Reply Br. 16-17; Ans. 11-12).

30

31 The Examiner finds that Lin teaches an LMS adaptive noise canceller 1412 that includes  
32 a sub-band spectral subtraction routine 1410 (Ans. 13). The Examiner further finds that  
33 Appellant has not provided a specific definition of “sub-band spectral subtractive routine”  
34 and thus, giving the term its broadest reasonable interpretation, the term can include any  
35 adaptive filter (Ans. 12). We cannot agree.

36

37 Appellant’s Specification explains that “sub-band spectral subtraction algorithms are . . .  
38 known to those skilled in the art” in paragraph [0023], sets forth the sub-band spectral

1 subtractive mechanism in paragraph [0032], and also sets forth the function that implements  
 2 the sub-band spectral noisereduction algorithm (Appendix-Spec: 21-22). Although  
 3 Appellant's Specification does not specifically define the term "sub-band spectral  
 4 subtractive routine," this is a specific claim term for a specific type of filtering (Spec.  
 5 ¶[0032]). Any interpretation that fails to give weight to "sub-band," "spectral,"  
 6 "subtractive," and "routine" deprives the words in this claim term of their normal meaning.  
 7 Thus, the "sub-band spectral subtractive routine" does not include just *any* adaptive filter,  
 8 but rather refers to a specific filtering routine. Further, the output from Lin's LMS based  
 9 adaption circuit is fed to a summer 1124, 1224 (Lin Fig. 14), not a sub-band spectral  
 10 subtractive routine. A summer is an additive circuit and not a subtractive circuit. Also, Lin  
 11 does not describe the summer as operating on a sub-band. Thus, because Lin does not  
 12 disclose each and every element of Appellant's invention, Lin does not anticipate claims 1-  
 13 15. *RCA Corp. v. Appl. Dig. Data Sys., Inc.*, 730 F.2d 1440, 1444 (Fed. Cir. 1984).  
 14

15 Thus, the Examiner's assertion that Margolin does not define "civilian airspace" (and is not  
 16 entitled to the common meaning of the term) is for the purpose of using a broader interpretation  
 17 of the prior art than it merits. Indeed, as has been shown, the Examiner has used even more than  
 18 the broadest *possible* interpretation of the prior art.  
 19  
 20

### 21 Ground C.

22  
 23 Whether Margolin had a duty to define "safety" or whether he was entitled to use the common  
 24 meaning of the term; and whether Margolin defined a particular level of safety.  
 25

26 In the Office Action of February 15, 2011 on page 10 (Evidence Appendix Exhibit 6 at 446) the  
 27 Examiner stated:

28 Some of applicant's remarks are that the prior art does not recite the phrase, "safely flying an  
 29 unmanned aerial vehicle in civilian airspace comprising:...". Applicant thus insists that the  
 30 rejection is conclusory and is not supported. **The examiner disagrees and notes that any**  
 31 **particular level of safety is not described or disclosed in the specification nor is there**  
 32 **any meaning provided for "civilian airspace" or "safety".**  
 33

34 Margolin does define safety as well as the particular level of safety. In Application page 4, lines  
 35 24-26 (Evidence Appendix Exhibit 1 at 64):

36 **[010]** It is important when flying a UAV in an airspace shared with other aircraft, both  
 37 civilian and military, that collisions during all phases of flight (including taking off and  
 38 landing) not happen.

1 This is consistent with the aerospace community's use of the term. MPEP § 2111.01 Parts I and  
2 III cited above apply here as well, as does the above cited reference **Sensing Requirements for**  
3 **Unmanned Air Vehicles**, AFRL's Air Vehicles Directorate, Control Sciences Division, Systems  
4 Development Branch, Wright-Patterson AFB OH, June 2004, which was filed with the  
5 application. (See Evidence Appendix Exhibit 9 at 462 and Exhibit 10 at 465.)

6 Engineers from the Air Vehicles Directorate transferred unmanned air vehicle (UAV)  
7 sensing system requirements for airspace operations to civilian UAV users and developers.  
8 These requirements represent design goals on which to base future sensing subsystem  
9 designs, filling an omission in UAV technology planning. Directorate engineers are  
10 continuing to develop the technologies that will enable future UAVs to coexist with manned  
11 aircraft in both military and civilian airspace. **Incorporating these requirements will**  
12 **ensure that engineers design future UAVs to detect possible conflicts, such as midair**  
13 **collisions or runway incursions, and take action to avoid them.**  
14

15 {Emphasis added}

16  
17 Another reference filed by Margolin in his patent application is **Presentation: Developing Sense**  
18 **& Avoid Requirements for Meeting an Equivalent Level of Safety** given by RUSS WOLFE,  
19 Technology IPT Lead, Access 5 Project at UVS Tech 2006. (January 18, 2006). (See Evidence  
20 Appendix Exhibit Appendix Exhibit 9 at 462 and Exhibit 11 at 469.)

21  
22 Page 7 of the presentation (Evidence Appendix Exhibit 11 at 475) says:

23 **Task 1: ELOS Definition Document**

24 Definition and Measures of Performance

25 Definition: "Equivalent level of safety to manned aircraft see-and-avoid" is the  
26 capability to provide situational awareness with adequate time to detect conflicting  
27 traffic and the ability to take appropriate action necessary to avoid collisions."  
28

29 And there is only one level of safety.

30  
31 In the remarks cited above by FAA Administrator Babbit in a speech he gave November 18,  
32 2009. (See Evidence Appendix Exhibit 14 at 498) he said:

33 Good afternoon, and thank you, John [Langford, Chairman & President, Aurora Flight  
34 Sciences]. It's an exciting time in aviation and to be involved with introducing new  
35 technology into the National Airspace System. It's also a good time to be thinking and

1 talking about personal and professional responsibility — something I have unfortunately had  
 2 to do too much of lately. **But we all — every professional in aviation — have a shared**  
 3 **responsibility to make this system as absolutely as safe as it can be, and never to just a**  
 4 **level where we would ever say, “We could do more, but this is safe enough”.**

5  
 6 {Emphasis added}

7  
 8 Again, the significance of the Examiner’s strategy in denying Margolin the common use of the  
 9 term can be found in *Ex parte MAURICE GIVENS* Appeal 2009-003414, BPAI Informative  
 10 Decision, Decided: August 6, 2009. (See Evidence Appendix Exhibit 13 at 494.)

11  
 12 The Examiner’s assertion that Margolin does not define “safety” or “a particular level of safety”  
 13 (and is not entitled to the common meaning of the terms) is for the purpose of using a broader  
 14 interpretation of the prior art than it merits. Indeed, as has been shown, the Examiner has used  
 15 even more than the broadest *possible* interpretation of the prior art.

16  
 17 **Ground D.**

18  
 19 Whether the Examiner’s assertion that “It is believed that the aircraft flown in the prior art is  
 20 flown safely ...” (and which is asserted without evidence) is proper.

21  
 22 This strikes at the heart of Margolin’s invention. If “ ... the aircraft flown in the prior art is flown  
 23 safely ...” then Margolin’s invention is irrelevant. And it would not be useful.

24  
 25 According to MPEP § 2144.03 **Reliance on Common Knowledge in the Art or "Well**  
 26 **Known" Prior Art [R-6] - 2100 Patentability** the Examiner’s statement constitutes Taking  
 27 Official Notice.

28  
 29 However, the Examiner has completely failed to follow the rules for Taking Official Notice.

30  
 31 **1.** The Examiner failed to provide any evidence for his statement. From § 2144.03(A):

32 Official notice without documentary evidence to support an examiner's conclusion is  
 33 permissible only in some circumstances. While "official notice" may be relied on, these  
 34 circumstances should be rare when an application is under final rejection or action under 37  
 35 CFR 1.113. Official notice unsupported by documentary evidence should only be taken by  
 36 the examiner where the facts asserted to be well-known, or to be common knowledge in the  
 37 art are capable of instant and unquestionable demonstration as being well-known. As noted

1 by the court in *In re Ahlert*, 424 F.2d 1088, 1091, 165 USPQ 418, 420 (CCPA 1970), the  
 2 notice of facts beyond the record which may be taken by the examiner must be "capable of  
 3 such instant and unquestionable demonstration as to defy dispute"  
 4

5 **2.** The Examiner failed to provide even a technical line of reasoning for making his statement.  
 6 From MPEP § 2144.03(B):  
 7

8 **B. If Official Notice Is Taken of a Fact, Unsupported by Documentary Evidence, the**  
 9 **Technical Line of Reasoning Underlying a Decision To Take Such Notice Must Be**  
 10 **Clear and Unmistakable**  
 11

12 \*\*In certain older cases, official notice has been taken of a fact that is asserted to be  
 13 "common knowledge" without specific reliance on documentary evidence where the fact  
 14 noticed was readily verifiable, such as when other references of record supported the noticed  
 15 fact, or where there was nothing of record to contradict it. See *In re Soli*, 317 F.2d 941, 945-  
 16 46, 137 USPQ 797, 800 (CCPA 1963) (accepting the examiner's assertion that the use of "a  
 17 control is standard procedure throughout the entire field of bacteriology" because it was  
 18 readily verifiable and disclosed in references of record not cited by the Office); ...  
 19

20 **3.** Because the Examiner made his statement in a Final Office Action Margolin was denied the  
 21 opportunity to challenge the Examiner to provide evidence for his statement as provided for in  
 22 MPEP § 2144.03(C):  
 23

24 **C. If Applicant Challenges a Factual Assertion as Not Properly Officially Noticed or**  
 25 **Not Properly Based Upon Common Knowledge, the Examiner Must Support the**  
 26 **Finding With Adequate Evidence**  
 27

28 To adequately traverse such a finding, an applicant must specifically point out the supposed  
 29 errors in the examiner's action, which would include stating why the noticed fact is not  
 30 considered to be common knowledge or well-known in the art. See 37 CFR 1.111(b).  
 31

32 **4.** The Examiner took Official Notice in an Office Action, which constituted both a new issue  
 33 and a new ground of rejection, and improperly made the Office Action final. From MPEP §  
 34 2144.03(D):

35 **D. Determine Whether the Next Office Action Should Be Made Final**  
 36

37 If the examiner adds a reference in the next Office action after applicant's rebuttal, and the  
 38 newly added reference is added only as directly corresponding evidence to support the prior  
 39 common knowledge finding, and it does not result in a new issue or constitute a new ground  
 40 of rejection, the Office action may be made final. If no amendments are made to the claims,  
 41 the examiner must not rely on any other teachings in the reference if the rejection is made  
 42 final. If the newly cited reference is added for reasons other than to support the prior

1 common knowledge statement and a new ground of rejection is introduced by the examiner  
2 that is not necessitated by applicant's amendment of the claims, the rejection may not be  
3 made final. See MPEP § 706.07(a).  
4

5 **5.** The Examiner's statement is dead wrong. It was dead wrong in 2006 (Margolin's priority  
6 date) and it is still dead wrong today.

7  
8 Margolin's application used as exemplars the crash of the Predator patrolling the U.S. Southern  
9 border (See Application page 4 lines 13-21) and the crash of the Lockheed Martin Polecat. (See  
10 Application page 4, lines 6-9 and the reference from Aviation Week & Space Technology  
11 **Lockheed Martin's Polecat UCAV Demonstrator Crashes** which was filed with the  
12 application and is reproduced here as Evidence Appendix Exhibit 12 at 489.) The Examiner  
13 indicated he had considered the reference in Evidence Appendix Exhibit 9 at 463.  
14

15 Margolin's Application contained the reference **Sensing Requirements for Unmanned Air**  
16 **Vehicles**, AFRL Air Vehicles (Evidence Appendix Exhibit 10 at 465). The second paragraph  
17 stated that "Present UAVs cannot detect manned aircraft and conflict situations and, therefore,  
18 they cannot share airspace with manned aircraft."  
19

20 Another reference filed by Margolin in his patent application is **Presentation: Developing Sense**  
21 **& Avoid Requirements for Meeting an Equivalent Level of Safety** given by RUSS WOLFE,  
22 Technology IPT Lead, Access 5 Project at UVS Tech 2006. (January 18, 2006). (See Evidence  
23 Appendix Exhibit Appendix Exhibit 9 at 462 and Exhibit 11 at 469.) The conference was held in  
24 order to develop UAS Collision Avoidance Initiatives. If UAVS were already being flown safely  
25 the conference would not have been necessary.  
26

27 The aerospace community had not solved the problem by November 2009 when FAA  
28 Administrator Babbitt gave his speech (Evidence Appendix Exhibit 14 at 498) when he said  
29 (second paragraph):

30 So if we are direct with ourselves here, as of today, unmanned aircraft systems are not ready  
31 for seamless or routine use yet in civilian airspace. The idea of pilots flying remotely has  
32 been around for a long time. And it is, I truly believe, the way of the future. But where we  
33 are, on numerous fronts, they're not ready for open access to the NAS and we can't give you  
34 the thumbs up.

1 Even more recently, an article from TheLedger.com (Lakeland, FL) dated July 6, 2010 details  
2 the problems with UAVs. (The article refers to UAVs by the much older term “drones.”) The  
3 article is called **Pentagon Accident Reports Suggest Military's Drone Aircraft Plagued With**  
4 **Problems** and is reproduced in Evidence Appendix Exhibit 15 at 502.

5  
6 The Examiner’s statement, presented without evidence, is contradicted by the evidence shown in  
7 the references Margolin filed with his application (and which the Examiner asserted he had  
8 considered) and by more recent evidence.

9  
10

1 **VIII. CLAIMS APPENDIX**

2  
3 A copy of the claims involved in the present appeal is attached hereto as Appendix A.  
4

5 **IX. EVIDENCE APPENDIX**

6  
7 The Evidence Appendix is attached as Appendix B. With the exception of Exhibits 2 and 4 the  
8 following exhibits were reproduced from the Image File Wrapper. Presumably, the reason they  
9 are in the Image File Wrapper is because they were entered by the Examiner. Exhibits 2 and 4  
10 were cited by the Examiner, which counts as being constructively entered by the Examiner.  
11

12	Exhibit 1	Patent Application as filed .....	61
13	Exhibit 2	U.S. Patent 5,904,724 .....	87
14	Exhibit 3	First Office Action on the Merits .....	102
15	Exhibit 4	U. S. Patent Application 20050004723 (Duggan) .....	115
16	Exhibit 5	Applicant's Response to First Office Action .....	193
17	Exhibit 6	Second Office Action .....	435
18	Exhibit 7	Applicant's Summary of Telephone Interview with Examiner .....	452
19	Exhibit 8	Applicant's Summary of Telephone Interview with Examiner's SPE ...	457
20	Exhibit 9	IDS References Considered by Examiner .....	461
21	Exhibit 10	<b>Sensing Requirements for Unmanned Air Vehicles</b> , AFRL Air Vehicles Directorate .....	465
22			
23	Exhibit 11	<b>Developing Sense and Avoid Requirements for Meeting An Equivalent Level of Safety</b> , Russel Wolfe .....	469
24			
25	Exhibit 12	Article - <b>Lockheed's Polecat UCAV Demonstrator Crashes</b> , Aviation Week & Space Technology, by Amy Butler, 03/19/2007, page 44 .....	489
26			

27  
28 New evidence is being presented in this appeal. This new evidence is necessary because in the  
29 Second Office Action mailed 2/15/2011 the Examiner added a section called **Response to**  
30 **Arguments** where he expanded the grounds for rejection that he made in the First Office Action.  
31 As a result he constructively introduced new grounds for rejection.



1 1. Margolin had not amended his claims in his Response to the First Office Action.

2  
3 2. The Examiner could have made his new grounds for rejection in his First Office Action  
4 but failed to do so.

5  
6 The interests of fairness, as well as Rule 706.07(a), require that Margolin be allowed to introduce  
7 this new evidence.

8  
9 In addition, there is a conflict between MPEP § 41.33 **Amendments and affidavits or other**  
10 **evidence after appeal** (d)(1) and the **Streamlined Procedure for Appeal Brief Review**  
11 published in the Federal Register Vol. 75, No. 60. (United States Patent and Trademark Office  
12 Docket No.: PTO-P-2010-0026.)

13  
14 Prior to the Streamlined Procedure, the Examiner decided if an Appeal Brief was compliant with  
15 the Rules.<sup>2</sup> Under the Streamlined Procedure this is now done by The Chief Judge of the Board  
16 of Patent Appeals and Interferences (BPAI) or his designee. Since the Chief Judge probably has  
17 more important things to do, compliance will probably be determined by a paralegal.

18  
19 That would be ok except for § 41.33 **Amendments and affidavits or other evidence after**  
20 **appeal** (d)(1):

21 (1) An affidavit or other evidence filed after the date of filing an appeal pursuant to §  
22 41.31(a)(1) through (a)(3) and prior to the date of filing a brief pursuant to § 41.37 may be  
23 admitted if the examiner determines that the affidavit or other evidence overcomes all  
24 rejections under appeal and that a showing of good and sufficient reasons why the affidavit  
25 or other evidence is necessary and was not earlier presented has been made.  
26

27 The Chief Judge's paralegal is not the Examiner and is unlikely to have the authority to  
28 determine whether Margolin's new evidence overcomes the Examiner's rejections.<sup>3</sup>

---

<sup>2</sup> This comes under the category of putting the Fox in charge of the Hen House.

<sup>3</sup> As previously noted, the new evidence is necessary to respond the Examiner's expanded grounds for rejection, which is why it could not be presented earlier. Margolin will remind the Board that if it does not allow Margolin to submit this new evidence the U.S. District Court for the District of Columbia will. (*Hyatt v. Kappos*, No. 2007-1066, US Court of Appeals for the Federal Circuit, 2010 US App. LEXIS 23117, 8 November 2010)

1 Exhibit 13 Ex parte MAURICE GIVENS Appeal 2009-003414  
2 BPAI Informative Decision, Decided: August 6, 2009 ..... 493

3  
4 Exhibit 14 Speech - "**Safety Must Come First**"; J. Randolph Babbitt, FAA  
5 Administrator; Scottsdale, AZ; November 18, 2009;  
6 [http://www.faa.gov/news/speeches/news\\_story.cfm?newsId=10964](http://www.faa.gov/news/speeches/news_story.cfm?newsId=10964) .... 498

7  
8 Exhibit 15 Article - **Pentagon Accident Reports Suggest Military's Drone**  
9 **Aircraft Plagued With Problems**, by David Zucchini, from  
10 The Ledger.com, July 6, 2010.  
11 <http://www.theledger.com/article/20100706/NEWS/7065101> ..... 502

12  
13  
14 **X. RELATED PROCEEDINGS**

15  
16 There are no decisions rendered by a court or by BPAI in this application.

17  
18  
19 Respectfully submitted,

20  
21 /Jed Margolin/

22  
23 Jed Margolin  
24 pro se inventor  
25 June 16, 2011  
26 (775) 847-7845

27  
28  
29  
30 I hereby certify that this correspondence is being filed through the USPTO's Electronic Filing  
31 System.

32  
33 Date: June 16, 2011

Inventor's Signature: /Jed Margolin/

34  
35  
Jed Margolin

1  
2  
3  
4  
5  
6  
7  
8  
9  
10  
11  
12  
13  
14  
15  
16  
17  
18  
19  
20  
21  
22  
23  
24  
25  
26  
27  
28  
29  
30  
31

**Claims Appendix**

Claims involved in the Appeal of Application Serial Number 11/736,356

1. A system for safely flying an unmanned aerial vehicle in civilian airspace comprising:

- (a) a ground station equipped with a synthetic vision system;
- (b) an unmanned aerial vehicle capable of supporting said synthetic vision system;
- (c) a remote pilot operating said ground station;
- (d) a communications link between said unmanned aerial vehicle and said ground station;
- (e) a system onboard said unmanned aerial vehicle for detecting the presence and position of nearby aircraft and communicating this information to said remote pilot;

whereas said remote pilot uses said synthetic vision system to control said unmanned aerial vehicle during at least selected phases of the flight of said unmanned aerial vehicle, and during those phases of the flight of said unmanned aerial vehicle when said synthetic vision system is not used to control said unmanned aerial vehicle said unmanned aerial vehicle is flown using an autonomous control system.

2. The system of claim 1 whereby said selected phases of the flight of said unmanned aerial vehicle comprise:

- (a) when said unmanned aerial vehicle is within a selected range of an airport or other designated location and is below a first specified altitude;

- (b) when said unmanned aerial vehicle is outside said selected range of an airport or other designated location and is below a second specified altitude.

3. The system of claim 1 further comprising a system onboard said unmanned aerial vehicle for periodically transmitting the identification, location, altitude, and bearing of said unmanned aerial vehicle.

1 4. The system of claim 1 further comprising a system onboard said unmanned aerial vehicle for  
2 providing a communications channel for Air Traffic Control and the pilots of other aircraft to  
3 communicate directly with said remote pilot.  
4

5 5. A system for safely flying an unmanned aerial vehicle in civilian airspace comprising:

- 6 (a) a ground station equipped with a synthetic vision system;
- 7 (b) an unmanned aerial vehicle capable of supporting said synthetic vision system;
- 8 (c) a remote pilot operating said ground station;
- 9 (d) a communications link between said unmanned aerial vehicle and said ground station;
- 10 (e) a system onboard said unmanned aerial vehicle for detecting the presence and position  
11 of nearby aircraft and communicating this information to said remote pilot;

12  
13 whereas said remote pilot uses said synthetic vision system to control said unmanned aerial  
14 vehicle during at least selected phases of the flight of said unmanned aerial vehicle, and  
15 during those phases of the flight of said unmanned aerial vehicle when said synthetic vision  
16 system is not used to control said unmanned aerial vehicle said unmanned aerial vehicle is  
17 flown using an autonomous control system, and

18  
19 whereas the selected phases of the flight of said unmanned aerial vehicle comprise:

20 (a) when said unmanned aerial vehicle is within a selected range of an airport or other  
21 designated location and is below a first specified altitude;

22 (b) when said unmanned aerial vehicle is outside said selected range of an airport or other  
23 designated location and is below a second specified altitude.  
24

25 6. The system of claim 5 further comprising a system onboard said unmanned aerial vehicle for  
26 periodically transmitting the identification, location, altitude, and bearing of said unmanned  
27 aerial vehicle.  
28

- 1 7. The system of claim 5 further comprising a system onboard said unmanned aerial vehicle for  
2 providing a communications channel for Air Traffic Control and the pilots of other aircraft to  
3 communicate directly with said remote pilot.  
4
- 5 8. A method for safely flying an unmanned aerial vehicle as part of a unmanned aerial system  
6 equipped with a synthetic vision system in civilian airspace comprising the steps of:  
7
- 8 (a) using a remote pilot to fly said unmanned aerial vehicle using synthetic vision during at  
9 least selected phases of the flight of said unmanned aerial vehicle, and during those phases  
10 of the flight of said unmanned aerial vehicle when said synthetic vision system is not used to  
11 control said unmanned aerial vehicle an autonomous control system is used to fly said  
12 unmanned aerial vehicle;  
13
- 14 (b) providing a system onboard said unmanned aerial vehicle for detecting the presence and  
15 position of nearby aircraft and communicating this information to said remote pilot.  
16
- 17 9. The method of claim 8 whereby said selected phases of the flight of said unmanned aerial  
18 vehicle comprise:
- 19 (a) when said unmanned aerial vehicle is within a selected range of an airport or other  
20 designated location and is below a first specified altitude;
- 21 (b) when said unmanned aerial vehicle is outside said selected range of an airport or other  
22 designated location and is below a second specified altitude.  
23
- 24 10. The method of claim 8 further comprising the step of providing a system onboard said  
25 unmanned aerial vehicle for periodically transmitting the identification, location, altitude, and  
26 bearing of said unmanned aerial vehicle.  
27
- 28 11. The method of claim 8 further comprising the step of providing a system onboard said  
29 unmanned aerial vehicle for providing a communications channel for Air Traffic Control and the  
30 pilots of other aircraft to communicate directly with said remote pilot.

1 12. A method for safely flying an unmanned aerial vehicle as part of a unmanned aerial system  
2 equipped with a synthetic vision system in civilian airspace comprising the steps of:

3  
4 (a) using a remote pilot to fly said unmanned aerial vehicle using synthetic vision during at  
5 least selected phases of the flight of said unmanned aerial vehicle, and during those phases  
6 of the flight of said unmanned aerial vehicle when said synthetic vision system is not used to  
7 control said unmanned aerial vehicle an autonomous control system is used to fly said  
8 unmanned aerial vehicle;

9  
10 (b) providing a system onboard said unmanned aerial vehicle for detecting the presence and  
11 position of nearby aircraft and communicating this information to said remote pilot;

12

13 whereas said selected phases of the flight of said unmanned aerial vehicle comprise:

14 (a) when said unmanned aerial vehicle is within a selected range of an airport or other  
15 designated location and is below a first specified altitude;

16 (b) when said unmanned aerial vehicle is outside said selected range of an airport or other  
17 designated location and is below a second specified altitude.

18

19 13. The method of claim 12 further comprising the step of providing a system onboard said  
20 unmanned aerial vehicle for periodically transmitting the identification, location, altitude, and  
21 bearing of said unmanned aerial vehicle.

22

23 14. The method of claim 12 further comprising the step of providing a system onboard said  
24 unmanned aerial vehicle for providing a communications channel for Air Traffic Control and the  
25 pilots of other aircraft to communicate directly with said remote pilot.

**Appendix B - Evidence Appendix**

1			
2	Exhibit 1	Patent Application as filed .....	61
3	Exhibit 2	U.S. Patent 5,904,724 (Margolin).....	87
4	Exhibit 3	First Office Action on the Merits .....	102
5	Exhibit 4	U. S. Patent Application 20050004723 (Duggan) .....	115
6	Exhibit 5	Applicant's Response to First Office Action .....	193
7	Exhibit 6	Second Office Action .....	435
8	Exhibit 7	Applicant's Summary of Telephone Interview with Examiner .....	452
9	Exhibit 8	Applicant's Summary of Telephone Interview with	
10		Examiner's SPE .....	457
11	Exhibit 9	IDS References Considered by Examiner .....	461
12	Exhibit 10	<b>Sensing Requirements for Unmanned Air Vehicles,</b>	
13		AFRL Air Vehicles Directorate .....	465
14	Exhibit 11	<b>Developing Sense and Avoid Requirements for Meeting</b>	
15		<b>An Equivalent Level of Safety, Russel Wolfe .....</b>	469
16	Exhibit 12	Article - <b>Lockheed's Polecats UCAV Demonstrator Crashes</b> , Aviation	
17		Week & Space Technology, by Amy Butler, 03/19/2007, page 44 .....	489
18	Exhibit 13	Ex parte MAURICE GIVENS Appeal 2009-003414	
19		BPAI Informative Decision, Decided: August 6, 2009 .....	493
20	Exhibit 14	Speech - " <b>Safety Must Come First</b> "; J. Randolph Babbitt,	
21		FAA Administrator; November 18, 2009, FAA Web site .....	498
22	Exhibit 15	Article - <b>Pentagon Accident Reports Suggest Military's Drone</b>	
23		<b>Aircraft Plagued With Problems</b> , by David Zucchini, from	
24		The Ledger.com, July 6, 2010.	
25		<a href="http://www.theledger.com/article/20100706/NEWS/7065101">http://www.theledger.com/article/20100706/NEWS/7065101</a> ..	502
26			

# Exhibit 1

# Exhibit 1



**UNITED STATES PATENT APPLICATION FOR PATENT  
FOR**

**SYSTEM AND METHOD FOR SAFELY FLYING UNMANNED AERIAL VEHICLES IN  
CIVILIAN AIRSPACE**

**INVENTOR: JED MARGOLIN**

**SYSTEM AND METHOD FOR SAFELY FLYING UNMANNED  
AERIAL VEHICLES IN CIVILIAN AIRSPACE**

**CROSS REFERENCES TO RELATED APPLICATIONS**

**[001]** This application claims the benefit of U.S. Provisional Application No. 60/745,111 filed on April 19, 2006.

**BACKGROUND OF THE INVENTION - Field of Invention**

**[002]** This invention relates to the field of remotely piloted vehicles (RPVs) and unmanned aerial vehicles (UAVs). RPV is an older term for UAV. UCAV shall mean "Unmanned Combat Aerial Vehicle." UCAV is also sometimes defined as an "Uninhabited Combat Aerial Vehicle." UCAV is a UAV that is intended for use in combat. UAS means "Unmanned Aerial System." UCAS means "Unmanned Combat Air System." ROA means "Remotely Operated Aircraft." The characteristics all these vehicles have in common is that there is no human pilot onboard and although they may be operated autonomously they can also be controlled by a remotely located operator or pilot. The term UAV shall be used as a generic term for such vehicles. "Synthetic Vision" is the current term for three dimensional projected image data presented to the pilot or other observer. Another term for "Synthetic Vision" is "Synthetic Environment." An older term for "Synthetic Vision" is "Virtual Reality." The term "Augmented Reality" (AR) refers to a human/computer interaction in which synthetic, computer generated elements are mixed or juxtaposed with real world elements in such a way that the synthetic elements appear to be part of the real world. A common method used by Augmented Reality systems is to combine and overlay a synthetic vision system with the video from one or more video or infrared cameras. Augmented

Reality is also sometimes referred to as “Enhanced Vision.” The term “Remote Pilot” shall mean the same as “Remote Operator.” The term “Sense and Avoid” shall mean the same as “See and Avoid.”

### **BACKGROUND OF THE INVENTION – Prior Art**

[003] The use of Synthetic Vision in flying a UAV is taught by U.S. Patent 5,904,724 **Method and apparatus for remotely piloting an aircraft** issued May 18, 1999 to Margolin (the present Applicant) which is hereby incorporated by reference. From the **Abstract:**

A method and apparatus that allows a remote aircraft to be controlled by a remotely located pilot who is presented with a synthesized three-dimensional projected view representing the environment around the remote aircraft. According to one aspect of the invention, a remote aircraft transmits its three-dimensional position and orientation to a remote pilot station. The remote pilot station applies this information to a digital database containing a three dimensional description of the environment around the remote aircraft to present the remote pilot with a three dimensional projected view of this environment. The remote pilot reacts to this view and interacts with the pilot controls, whose signals are transmitted back to the remote aircraft. In addition, the system compensates for the communications delay between the remote aircraft and the remote pilot station by controlling the sensitivity of the pilot controls.

[004] The system by which an aircraft periodically transmits its identification, location, altitude, and bearing was taught by U.S. Patent 5,153,836 issued October 10, 1992 to Fraughton et al. and was materially adopted by the FAA as **Automatic Dependent Surveillance-Broadcast (ADS-B)**. According the article **Gulf of Mexico Helo Ops Ready for ADS-B** in *Aviation Week & Space Technology* (02/26/2007, page 56):

By the end of 2010, FAA expects to have the ADS-B system tested and operationally acceptable for the NAS, with Houston Center providing services in the Gulf region. By 2013, all of the U.S. is scheduled to be covered with ground infrastructure.

### **BACKGROUND OF THE INVENTION – Current Practice**

[005] The current practice in flying UAVs in civilian airspace is typified by the report **Sensing Requirements for Unmanned Air Vehicles** by AFRL's Air Vehicles Directorate, Control Sciences Division, Systems Development Branch, Wright-Patterson AFB OH, June 2004, which relies on computer-intelligence to use sensors to sense and avoid other aircraft.

**[006]** According to the presentation entitled **Developing Sense & Avoid Requirements for Meeting an Equivalent Level of Safety** given by Russ Wolfe, Technology IPT Lead, Access 5 Project at UVS Tech 2006 this had not changed as of January 18, 2006. Access 5 was a national project sponsored by NASA and Industry with participation by the FAA and DOD to introduce high altitude long endurance (HALE) remotely operated aircraft (ROA) to routine flights in the National Airspace System (NAS). Access 5 started in May 2004 but when NASA withdrew its support (and funding) the Industry members decided not to spend their own money and Access 5 was dissolved at the end of 2005.

**[007]** The presentation **Integration into the National Airspace System (NAS)** given by John Timmerman of the FAA's Air Traffic Organization (July 12, 2005) essentially says that under current UAS Operations in the NAS UAVs should not harm other aircraft or the public. (Page 3: *"While ensuring 'no harm' to other NAS customers and public"*)

**[008]** The article **Zone Ready for Drone**, April 7, 2006, on the web site for the FAA's Air Traffic Organization Employees states that,

Since March 29, a temporary flight restriction ... has limited access to the airspace along almost 350 miles of the border, expanding an earlier TFR near Nogales. The restriction is in effect nightly from 6 p.m. to 9 a.m., although that time can be expanded by issuance of a Notice to Airmen. Aircraft wishing to fly in the TFR when it is active must receive authorization from air traffic control prior to entry. Once in, pilots are required to maintain two-way communication with ATC and transmit a discrete transponder code.

The reason for the TFR is to enable Predator UAVs to patrol the border. The article quotes Stephen Glowacki, a Systems Safety and Procedures specialist with the FAA's Air Traffic Organization as saying:

This is an extreme situation that has been presented to us," states Stephen Glowacki, a Systems Safety and Procedures specialist with the FAA's Air Traffic Organization, stressing the nation's security. "We have been working with U.S. Customs and Border Protection to try and answer this situation."

Inserting UASs into the National Airspace System is not a simple feat. According to Glowacki, the technology and certification that will permit unmanned aircraft to "see and avoid" other air traffic is still eight to ten years away. In the mean time, a carefully controlled environment is needed.

**[009]** The track record of current UAV systems shows two major problem areas:

**a.** The communications link between the UAV and the ground station is unreliable, even at short ranges.

A recent example is the December 2006 crash of Lockheed Martin's Polecat UAV. When it lost communications with the ground it deliberately crashed itself to avoid flying into civil airspace. (See the article **Lockheed's Polecat UCAV Demonstrator Crashes** in Aviation Week & Space Technology, 03/19/2007, page 44.)

**b.** Autonomous Mode is not always very smart.

On April 25, 2006 the Predator UAV being used by the U.S. Customs and Border Protection agency to patrol the border crashed in Nogales, AZ. According to the NTSB report (NTSB Identification CHI06MA121) when the remote pilot switched from one console to another the Predator was inadvertently commanded to shut off its fuel supply and “With no engine power, the UAV continued to descend below line-of-site communications and further attempts to re-establish contact with the UAV were not successful.” In other words, the Predator crashed because the system did not warn the remote pilot he had turned off the fuel supply and it was not smart enough to turn its fuel supply back on. (Note that this is the same Predator discussed in the article **Zone Ready for Drone** previously mentioned.)

## **SUMMARY OF THE INVENTION**

**[010]** It is important when flying a UAV in an airspace shared with other aircraft, both civilian and military, that collisions during all phases of flight (including taking off and landing) not happen. The current method for accomplishing this is to place restrictions on all other traffic in an air corridor representing the path of the intended flight of the UAV, thereby inconveniencing other traffic and disrupting the National Airspace System.

### Synthetic Vision

**[011]** One objective of the present invention is to allow UAVs to safely share airspace with other users by using synthetic vision during at least some of the phases of the UAV's flight so that changes required to existing FAA rules and regulations are minimized.

**[012]** This may be accomplished by requiring that during selected phases of the flight the UAV be flown by a remote pilot using a Synthetic Vision System such as the one taught by U.S. Patent 5,904,724 **Method and apparatus for remotely piloting an aircraft**. These selected phases include:

(a) When the UAV is within a selected range of an airport or other designated location and is below a first specified altitude. This first specified altitude may be set high enough that, for all practical purposes, it may be considered unlimited.

(b) When the UAV is outside the selected range of an airport or other designated location and is below a second specified altitude.

**[013]** Each UAV flown under these conditions must be under the direct control of a remote pilot whose sole responsibility is the safe operation of that UAV. The rules will be similar to those for operating piloted aircraft with automatic pilot systems including those with autoland capability.

**[014]** UAVs not flying in airspace where the use of a Synthetic Vision System is required may be flown autonomously using an Autonomous Control System (ACS) as long as the following conditions are met:

(a) A remote pilot monitors the operation of the UAV at all times.

(b) The ACS periodically transmits its identification, location, altitude, and bearing. This information may also be broadcast by UAVs when operated by remote pilots using Synthetic Vision.

**[015]** All UAVs must use Radar (either active or passive) or other device to detect the range and altitude of nearby aircraft in order to perform “see and avoid” actions.

**[016]** All UAVs must provide a means for Air Traffic Control (ATC) and the pilots of other aircraft to communicate directly with the remote pilot.

**[017]** The preferred method for flying a UAV from one airport to another, such as in ferrying UAVs, would be to have the remote pilot at the originating airport be responsible for taking off and flying the UAV to the specified altitude. A remote pilot at the arrival airport would be

responsible for having the UAV descend and land. In between, once the UAV has reached the specified altitude and range the remote pilot monitoring the flight can be at any convenient location.

**[018]** Synthetic Vision may be enhanced by combining and/or overlaying it with the video from one or more video or infrared cameras or from synthetic aperture radar.

**[019]** The method described does not require material changes in the present air control system. It would also make UAV flights safer than most existing piloted flights where “see and avoid” is accomplished by looking out small windows providing a limited field of view and hoping you see any nearby aircraft in time to avoid a collision.

### Communication Link Failures

**[020]** The exact cause of the failure of the communications link in the Polecat crash mentioned previously has not been made public. Technical details for UAVs are limited because the systems are developed by private industry which generally considers such information proprietary. In addition, these are mostly military programs which limits public disclosure even more. (Indeed, although the Polecat crash took place in December 2006, it was not publicly reported until March 2007.)

**[021]** One factor that may cause a communication link to fail is if it is a high-bandwidth link since a high-bandwidth link is more susceptible to interference from other signals than is a lower-bandwidth link. The use of a synthetic vision system allows a lower-bandwidth link to be used which improves its reliability

**[022]** Another factor that affects a digital communications link when digital packets are sent through a network (such as an Internet-style network) is that the latency of the data packets cannot be assured either because the path may change from packet to packet or because packets may be lost. When data packets are lost the destination server usually times out and a request to resend the packet is issued which further increases the latency. Packets may also be lost simply because the path to a server takes longer than the server’s timeout period, causing the server to issue an unending series of requests to resend the packet. If a packet is lost, either outright or because the path is longer than the timeout period, transmission of data may stop entirely as most people who use the Internet have experienced.

**[023]** Because each data packet may take a different path, data packets may be received out-of-order. Standard Internet browsers such as Firefox and Microsoft Internet Explorer know to reassemble the packets in the correct order. A custom software application, such as that used to control UAVs, must do likewise to avoid becoming confused as to what is happening when.

**[024]** Some communications link failures may simply be due to the failure of the system to measure and adapt to the changing latency of the data packets. The importance of having the system measure and adapt to changing latencies is discussed in U.S. Patent 5,904,724 by the present inventor.

### Minimizing Communications Link Failures

**[025]** Communications Link Failures can be minimized by, first of all, properly designing the communications link to prevent the obvious types of failures described above.

**[026]** The next step is to provide redundant communications links. In addition to the standard types of communications links, an emergency backup communications link can use the standard commercial cell phone network as long as precautions are taken to keep hackers out. Casual hackers can be kept out by using Caller ID so if the UAV receives a call from an unauthorized number it answers the line and immediately hangs up. The reason this keeps out only casual hackers is because PBXs (Private Branch Exchanges) can be programmed to deliver any Caller ID number the PBX operator desires. Once the UAV User is authenticated the ACS hangs up and calls one or more preprogrammed telephone numbers to establish a link to be used for communications. Because of the time needed to establish this link it may be desirable to keep the emergency backup communications link on hot standby during takeoffs and landings. Keeping this link on hot standby during all phases of flight also provides a backup method for tracking the UAV by using the cell phone tower triangulation method. As with the standard communications links all data must be securely encrypted and the User must be periodically authenticated.

### What to Do if the Communication Link Fails

**[027]** If even the emergency backup Communications Link fails there is no choice but to go to the Autonomous Control System (ACS). What ACS does depends on the flight profile of the UAV.

**a.** If the UAV is on the runway on takeoff roll and is below V1 (the maximum abort speed of the aircraft) the takeoff is aborted.

**b.** If the UAV is between V1 and V2 (the minimum takeoff safety speed for the aircraft) the choice is nominally between aborting the takeoff (and overrunning the runway) and taking off. If all other UAV systems are operating properly, taking off is probably the better choice since it may be possible to re-establish the communications link once the UAV is in the air. However, if the UAV is equipped with a tailhook and the runway is equipped with arresting cables a suitable distance before the physical end of the runway, the UAV takeoff may still be safely aborted. The hook and arresting cable method is the standard method used on aircraft carriers for landing aircraft.

**c.** If the UAV is above V2 the UAV takes off and uses the takeoff profile that is assigned to each particular airport. It then climbs to an altitude high enough to avoid other traffic and, unless the communication link can be firmly established, flies to the nearest airport designated to receive UAVs in distress. Only in extreme cases should the ACS fly the UAV to a designated crash site.

### Autonomous Mode is not always very smart or even bug-free

**[028]** As noted in the case of the Predator previously mentioned, it crashed because the system did not warn the remote pilot he had turned off the fuel supply and it was not smart enough to turn its fuel supply back on. This may have been a design oversight or it may have been a software bug. Complex computer programs always have bugs no matter how brilliant or motivated the programmer(s). Treating every software error as a mistake to be punished only leads to paralysis so that no code gets written. After a good faith effort is made to “get it right” the systems must be thoroughly tested. And they must be tested on the ground.



Testing

[029] Complex systems are difficult to test, especially when one of its parts is a flying machine which, itself, is made up of several systems. Simulation of the individual subsystems is not good enough. A simulation of the entire system is also not good enough because, despite the best efforts, a simulation might not completely characterize the actual hardware and how the different hardware systems act together. The answer is to use Hardware-in-the-Loop simulation where the actual hardware is used with simulated inputs. A good description of Hardware-in-the-Loop simulation can be found in the article **Hardware-in-the-Loop Simulation** by Martin Gomez in Embedded Systems Design (November 30, 2001). The example Mr. Gomez used was an autopilot.

[030] The Ground Station is already on the ground so the proper place to start is with an actual ground station. The simplest configuration is to use an actual ground station with a simulation port connected directly to a computer that simulates the UAV. (See Figure 3). That probably isn't good enough because it only really tests the ground station. The next step is to use a ground station with an actual communication link. (See Figure 4.) This tests the ground station and the communications link.

[031] Since the idea is to test the UAV without actually flying it, the idea of Hardware-in-the-Loop testing is to use as much of the UAV's hardware as possible by using a computer to read the system's output control signals and present the proper sensor input signals. In between is a simulation of the physical model of how the UAV interacts with the physical universe. The UAV lives in an analog universe where space and time are continuously variable, subject only to the Planck Distance and Planck Time. (The Planck length is the scale at which classical ideas about gravity and space-time cease to be valid, and quantum effects dominate. This is the 'quantum of length', the smallest measurement of length with any meaning, roughly equal to  $1.6 \times 10^{-35}$  m. The Planck time is the time it would take a photon traveling at the speed of light to cross a distance equal to the Planck length. This is the 'quantum of time', the smallest measurement of time that has any meaning, and is equal to  $10^{-43}$  seconds.) The UAV's universe is also massively parallel, which is why simulating it with a single computer which is forced to perform different functions sequentially may not always produce accurate results. This can be ameliorated somewhat by oversampling and running the model faster than that required by Nyquist. (The Nyquist rate is the minimum; you don't have to settle for the minimum.)

[032] Ideally each sensor input and each actuator output should have its own processor and all the processors should be linked to a computer that contains the overall physical model of the UAV's universe (the Universe Processor). For example, the Universe Processor knows the location of the UAV, its attitude, its bearing, the air temperature and pressure, local weather, terrain, etc. This assumes that the sensors and actuators are completely characterized. If they are not, then the physical sensors and actuators can be used with devices that provide the proper physical stimulation to the sensors and measure the actual physical results of the actuators. The desired end result is that each device in the UAV flight hardware, especially if it contains software such as the Flight Control Computer, can be operated with its actual hardware and software. When the hardware or software is changed, the old device can be unplugged and the new version installed. This avoids the problem of relying on software that has been ported to hardware other than the hardware it runs on in the flight UAV. For example, the "C" programming language can be difficult to port to different computers because the definition of a "byte" in "C" can be different depending on the computer. Also note that the speed of the link connecting the sensors/actuators to the Universe Processor is determined by the speed of the fastest sensor/actuator, which also sets the minimum update rate of the Universe Processor.

[033] The type of operating system(s) used in simulation and testing is important. In particular, with a non-deterministic Operating System (such as Windows) you cannot count on getting the same result every time because the operating system includes random timing components. From the article "Basic concepts of real-time operating systems" by David Kalinsky (Nov. 18, 2003):

The key difference between general-computing operating systems and real-time operating systems is the need for " **deterministic** " timing behavior in the real-time operating systems. Formally, "deterministic" timing means that operating system services consume only known and expected amounts of time. In theory, these service times could be expressed as mathematical formulas. These formulas must be strictly algebraic and not include any random timing components. Random elements in service times could cause random delays in application software and could then make the application randomly miss real-time deadlines – a scenario clearly unacceptable for a real-time embedded system.

General-computing non-real-time operating systems are often quite non-deterministic. Their services can inject random delays into application software and thus cause slow responsiveness of an application at unexpected times. If you ask the developer of a non-real-time operating system for the algebraic formula describing the timing behavior of one of its services (such as sending a message from task to task), you will invariably not get an algebraic formula. Instead the developer of the non-real-time operating system (such as Windows, Unix or Linux) will just

give you a puzzled look. Deterministic timing behavior was simply not a design goal for these general-computing operating systems.

This means you may not be able to duplicate a failure. If you cannot duplicate a failure you cannot fix it. And, needless to say, the use of a non-deterministic Operating System in any part of the UAV flight hardware will result in a system that can never be completely trusted.

**[034]** Failure to do proper ground-based simulation can lead to expensive and/or embarrassing incidents such as this one reported by Aviation Week & Space Technology (02/26/2007, page 18):

The F-22 continues to encounter bumps in its first air expeditionary force deployment to Okinawa. The 12 aircraft from Langley AFB, Va., spent an unscheduled week at Hickam AFB, Hawaii, after the leading four had to abort the trip's last leg. As the Raptors reached the International Date Line, the navigation computers locked up so the aircraft returned to Hickam until a software patch was readied. "Apparently we had built an aircraft for the Western Hemisphere only," says a senior U.S. Air Force official. When the F-22s arrived at Kadena AB, Okinawa, some Japanese citizens held a protest against the aircraft's noise.

Although the F-22 is not a UAV the principle is the same.

**[035]** Testbeds can be used for more than just verifying that the system works as designed. They can also be used to verify that the system is designed properly for the User.

**[036]** In military programs, operational procedures can be developed and military personnel can be ordered to follow them. And they will follow them to the best of their ability because their careers are on the line. That doesn't change the fact that people operating poorly designed systems are more likely to make mistakes.

**[037]** Producing UAVs for the commercial market requires a different mindset. Civilians cannot be ordered to use a system whose design makes mistakes likely or maybe even inevitable. Civilians have the option to not buy the product if they don't like it. They also have the option to sue the manufacturer of a system whose design makes mistakes inevitable. Civilians injured on the ground also have the option to sue the manufacturer of a system whose design makes mistakes inevitable.

**[038]** Perhaps the UAV Industry can learn from the Video Game Industry where the standard practice is to hold focus groups early in the game's development using real video game players. Game Designers may not like the players' comments about their game but the players represent the game's ultimate customers. In addition, the video game companies employ people whose sole job is to extensively play the game before it is released and take careful notes of bugs, which are then passed on to the Game Developers. Although it is tempting to cut short the time devoted to testing in order to get the product out the door, a game released with too many bugs will be rejected by the marketplace and will fail.

**[039]** UAV manufacturers making UAV systems for the Government are protected from liability under the Supreme Court's 1988 decision in *Boyle v. United Technologies Corp*, 487 U.S. 500 (1988), where the Court held that if a manufacturer made a product in compliance with the government's design and production requirements, but it was defective and caused injury, the victim could not sue the manufacturer.

**[040]** Since UAV manufacturers making UAV systems for the civilian market do not have this protection they should consider who their customers really are. Although civilian UAV systems will probably be operated by civilian-rated pilots (at least initially), in a sense the UAV manufacturers are really designing their systems to meet the requirements of the Insurance Industry and doing proper on-ground testing is essential in making UAVs that will fly safely in civilian airspace. Military UAVs should meet the same standard because the crash of a military UAV that injures or kills civilians could ignite a political firestorm that would ground the entire UAV fleet.

#### The Reasons For Using Synthetic Vision during at least Takeoffs and Landings

**[041]** There are several reasons why the use of synthetic vision during at least takeoffs and landings can minimize the risk to the public.

**a.** The ACS must be programmed to deal with every possible problem in every possible situation that might arise. This is probably not possible until computers become sentient.

Even after 100 years of aviation, pilots still encounter situations and problems that have not been seen before. The way they deal with new situations and problems is to use their experience, judgment, and even intuition. Pilots have been remarkably successful in saving passengers and crew

under extremely difficult conditions such as when parts of their aircraft fall off (the top of the fuselage peels off) or multiply-redundant critical controls fail (no rudder control). Computers cannot be programmed to display judgment. They can only be programmed to display judgment-like behavior under conditions that have already been anticipated. UAVs should not be allowed to fly over people's houses until they are at least smart enough to turn on their own fuel supply.

Even so, this assumes the computer program has no bugs.

**b.** Complex computer programs always have bugs no matter how brilliant or motivated the programmer(s). As an example, look at almost every computer program ever written.

(See the article **Embedded Experts: Fix Code Bugs Or Cost Lives** by Rick Merritt in EE Times, April 10, 2006, as well as the article **Entries from the Software Failure Hall of Shame, Part 1** by Tom Rhineland in **g2zero**, July 6, 2006. g2zero at [www.g2zero.com](http://www.g2zero.com) is a community dedicated to discussing and advocating ways to improve software quality.)

While adding a sense-and-avoid capability to existing UAV systems is necessary it will increase the code complexity and increase the number of bugs in the software.

**c.** An Unmanned Combat Aerial Vehicle (UCAV) will have little chance against one flown by an experienced pilot using Synthetic Vision until Artificial Intelligence produces a sentient, conscious Being. At that point, all bets will be off because a superior sentient artificial Being may decide that war is stupid and refuse to participate. It may also decide that humans are obsolete or fit only to be its slaves.

#### Acceptable Risk

**[042]** Since it is impossible to anticipate every possible problem that might arise and it is impossible to write completely bug-free code it comes down to what is an acceptable risk.

**[043]** When a military aircraft is engaged in a military operation, a great deal of risk may be acceptable, especially if it is on a critical mission.

It is unacceptable to expose civilian aircraft flying in civil airspace, as well as the public on the ground, to this same level of risk except under truly exceptional circumstances.

[044] Synthetic Vision puts a human directly in the loop and makes flying a UAV in civilian airspace at least as safe as flying an aircraft with the pilot onboard.

### **BRIEF DESCRIPTION OF THE DRAWINGS**

[045] The invention may best be understood by referring to the following description and accompanying drawings which illustrate the invention. In the drawings:

[046] FIG. 1 is a general illustration showing a circular area of Range 102 around Airport 101.

[047] FIG. 2 is a general illustration showing the airspace around Airport 101 where UAVs must be flown by a remote pilot using synthetic vision. This airspace is represented by the hatched areas.

[048] FIG. 3 shows the simplest system for simulating the UAV system where an actual ground station is connected directly to a simulation computer that simulates the UAV.

[049] FIG. 4 shows a system for simulating the UAV system that includes an actual communications link.

### **DETAILED DESCRIPTION**

[050] In the following description, numerous specific details are set forth to provide a thorough understanding of the invention. However, it is understood that the invention may be practiced without these specific details. In other instances well-known circuits, structures, and techniques have not been shown in detail in order not to obscure the invention.

[051] Figure 1 shows a Distance Range 102 around Airport 101. While a circular area is shown for convenience any area whose shape can be defined may be used such as a square, rectangle, or other polygon. While Figure 1 shows the area around an airport any other designated location may be specified. Figure 2 shows an altitude profile of the airspace surrounding Airport 101. When the UAV is within Distance Range 102 of Airport 101 at an altitude below Selected Altitude 201 the UAV must be flown by a remote pilot using a Synthetic Vision System such as the one taught by U.S. Patent 5,904,724 **Method and apparatus for remotely piloting an aircraft**. When the UAV is outside Distance Range 102, within Distance Range 203, and is below Selected

Altitude 202 the UAV must also be flown by a remote pilot using a Synthetic Vision System. The airspace where the UAV must be flown by a remote pilot using a Synthetic Vision System is represented by the hatched areas in Figure 2.

**[052]** Each UAV flown under these conditions must be under the direct control of a remote pilot whose sole responsibility is the safe operation of that UAV. The rules will be similar to those for operating piloted aircraft with automatic pilot systems including those with autoland capability.

**[053]** UAVs flying beyond Distance Range 102, within Distance Range 203, and above Altitude 202 may be flown autonomously using an Autonomous Control System (ACS) as long as the following conditions are met:

(a) A remote pilot must monitor the operation of the UAV at all times. A remote pilot may monitor several UAVs simultaneously once it is established that this practice may be safely performed by a single pilot. For example, it may be preferable to have two remote pilots work as a team to monitor ten UAVS than to have each remote pilot separately monitor a group of five UAVs.

(b) The ACS must periodically transmit its identification, location, altitude, and bearing. This may be done through the use of a speech synthesis system on a standard aircraft communications frequency. This is for the benefit of pilots flying aircraft sharing the airspace. It may also be done through an appropriate digital system such as the one taught in U.S. Patent 5,153,836 **Universal dynamic navigation, surveillance, emergency location, and collision avoidance system and method** adopted by the FAA as ADS-B. This information may also be broadcast by UAVs when operated by remote pilots using Synthetic Vision.

**[054]** All UAVs must use radar (either active or passive) to detect the range and altitude of nearby aircraft in order to perform “see and avoid” actions. An example of a passive radar system is taught by U. S. Patent 5,187,485 **Passive ranging through global positioning system**. Other devices for detecting the range and altitude of nearby aircraft may also be used.

**[055]** All UAVs must provide a means for Air Traffic Control (ATC) and the pilots of other aircraft to communicate directly with the remote pilot. This may be accomplished by having the communication link between the remote pilot and the UAV relay communications with a standard aircraft transceiver onboard the UAV.

**[056]** Distance Range 203 extends to where it meets the area covered by another designated location such as another airport. The entire area covered by Distance Range 203 is termed a Designated Area. Another type of Designated Area is a large body of open water where the minimum safe altitude is determined by the height of a large ship riding the crest of a large wave.

**[057]** The preferred method for flying a UAV from one airport to another, such as in ferrying UAVs, would be to have the remote pilot at the originating airport be responsible for taking off and flying the UAV to the specified altitude. A remote pilot at the arrival airport would be responsible for having the UAV descend and land. This is similar to the longstanding practice of using Harbor Pilots to direct the movement of ships into and out of ports. In between the originating airport and destination airport, once the UAV has reached the specified altitude and range the remote pilot monitoring the flight can be at any convenient location.

**[058]** Long delays in the communications link (such as through geosynchronous satellites) make flying the UAV by direct control using synthetic vision more difficult and should be avoided.

**[059]** The method described does not require material changes in the present air control system. It would also make UAV flights safer than most existing piloted flights where “see and avoid” is accomplished by looking out small windows providing a limited field of view and hoping you see any nearby aircraft in time to avoid a collision.

**[060]** While preferred embodiments of the present invention have been shown, it is to be expressly understood that modifications and changes may be made thereto.



**CLAIMS**

What is claimed is:

1. A system for safely flying an unmanned aerial vehicle in civilian airspace comprising:
  - (a) a ground station equipped with a synthetic vision system;
  - (b) an unmanned aerial vehicle capable of supporting said synthetic vision system;
  - (c) a remote pilot operating said ground station;
  - (d) a communications link between said unmanned aerial vehicle and said ground station;
  - (e) a system onboard said unmanned aerial vehicle for detecting the presence and position of nearby aircraft and communicating this information to said remote pilot;

whereas said remote pilot uses said synthetic vision system to control said unmanned aerial vehicle during at least selected phases of the flight of said unmanned aerial vehicle, and during those phases of the flight of said unmanned aerial vehicle when said synthetic vision system is not used to control said unmanned aerial vehicle said unmanned aerial vehicle is flown using an autonomous control system.

2. The system of claim 1 whereby said selected phases of the flight of said unmanned aerial vehicle comprise:

- (a) when said unmanned aerial vehicle is within a selected range of an airport or other designated location and is below a first specified altitude;
- (b) when said unmanned aerial vehicle is outside said selected range of an airport or other designated location and is below a second specified altitude.

3. The system of claim 1 further comprising a system onboard said unmanned aerial vehicle for periodically transmitting the identification, location, altitude, and bearing of said unmanned aerial vehicle.

4. The system of claim 1 further comprising a system onboard said unmanned aerial vehicle for providing a communications channel for Air Traffic Control and the pilots of other aircraft to communicate directly with said remote pilot.

5. A system for safely flying an unmanned aerial vehicle in civilian airspace comprising:
- (a) a ground station equipped with a synthetic vision system;
  - (b) an unmanned aerial vehicle capable of supporting said synthetic vision system;
  - (c) a remote pilot operating said ground station;
  - (d) a communications link between said unmanned aerial vehicle and said ground station;
  - (e) a system onboard said unmanned aerial vehicle for detecting the presence and position of nearby aircraft and communicating this information to said remote pilot;

whereas said remote pilot uses said synthetic vision system to control said unmanned aerial vehicle during at least selected phases of the flight of said unmanned aerial vehicle, and during those phases of the flight of said unmanned aerial vehicle when said synthetic vision system is not used to control said unmanned aerial vehicle said unmanned aerial vehicle is flown using an autonomous control system, and

whereas the selected phases of the flight of said unmanned aerial vehicle comprise:

- (a) when said unmanned aerial vehicle is within a selected range of an airport or other designated location and is below a first specified altitude;
- (b) when said unmanned aerial vehicle is outside said selected range of an airport or other designated location and is below a second specified altitude.

6. The system of claim 5 further comprising a system onboard said unmanned aerial vehicle for periodically transmitting the identification, location, altitude, and bearing of said unmanned aerial vehicle.

7. The system of claim 5 further comprising a system onboard said unmanned aerial vehicle for providing a communications channel for Air Traffic Control and the pilots of other aircraft to communicate directly with said remote pilot.

8. A method for safely flying an unmanned aerial vehicle as part of a unmanned aerial system equipped with a synthetic vision system in civilian airspace comprising the steps of:

(a) using a remote pilot to fly said unmanned aerial vehicle using synthetic vision during at least selected phases of the flight of said unmanned aerial vehicle, and during those phases of the flight of said unmanned aerial vehicle when said synthetic vision system is not used to control said unmanned aerial vehicle an autonomous control system is used to fly said unmanned aerial vehicle;

(b) providing a system onboard said unmanned aerial vehicle for detecting the presence and position of nearby aircraft and communicating this information to said remote pilot.

9. The method of claim 8 whereby said selected phases of the flight of said unmanned aerial vehicle comprise:

(a) when said unmanned aerial vehicle is within a selected range of an airport or other designated location and is below a first specified altitude;

(b) when said unmanned aerial vehicle is outside said selected range of an airport or other designated location and is below a second specified altitude.

10. The method of claim 8 further comprising the step of providing a system onboard said unmanned aerial vehicle for periodically transmitting the identification, location, altitude, and bearing of said unmanned aerial vehicle.

11. The method of claim 8 further comprising the step of providing a system onboard said unmanned aerial vehicle for providing a communications channel for Air Traffic Control and the pilots of other aircraft to communicate directly with said remote pilot.

12. A method for safely flying an unmanned aerial vehicle as part of a unmanned aerial system equipped with a synthetic vision system in civilian airspace comprising the steps of:

(a) using a remote pilot to fly said unmanned aerial vehicle using synthetic vision during at least selected phases of the flight of said unmanned aerial vehicle, and during those phases of the flight of said unmanned aerial vehicle when said synthetic vision system is not used to control said unmanned aerial vehicle an autonomous control system is used to fly said unmanned aerial vehicle;

(b) providing a system onboard said unmanned aerial vehicle for detecting the presence and position of nearby aircraft and communicating this information to said remote pilot;

whereas said selected phases of the flight of said unmanned aerial vehicle comprise:

(a) when said unmanned aerial vehicle is within a selected range of an airport or other designated location and is below a first specified altitude;

(b) when said unmanned aerial vehicle is outside said selected range of an airport or other designated location and is below a second specified altitude.

13. The method of claim 12 further comprising the step of providing a system onboard said unmanned aerial vehicle for periodically transmitting the identification, location, altitude, and bearing of said unmanned aerial vehicle.

14. The method of claim 12 further comprising the step of providing a system onboard said unmanned aerial vehicle for providing a communications channel for Air Traffic Control and the pilots of other aircraft to communicate directly with said remote pilot.

**ABSTRACT OF THE DISCLOSURE**

A system and method for safely flying an unmanned aerial vehicle (UAV), unmanned combat aerial vehicle (UCAV), or remotely piloted vehicle (RPV) in civilian airspace uses a remotely located pilot to control the aircraft using a synthetic vision system during at least selected phases of the flight such as during take-offs and landings.

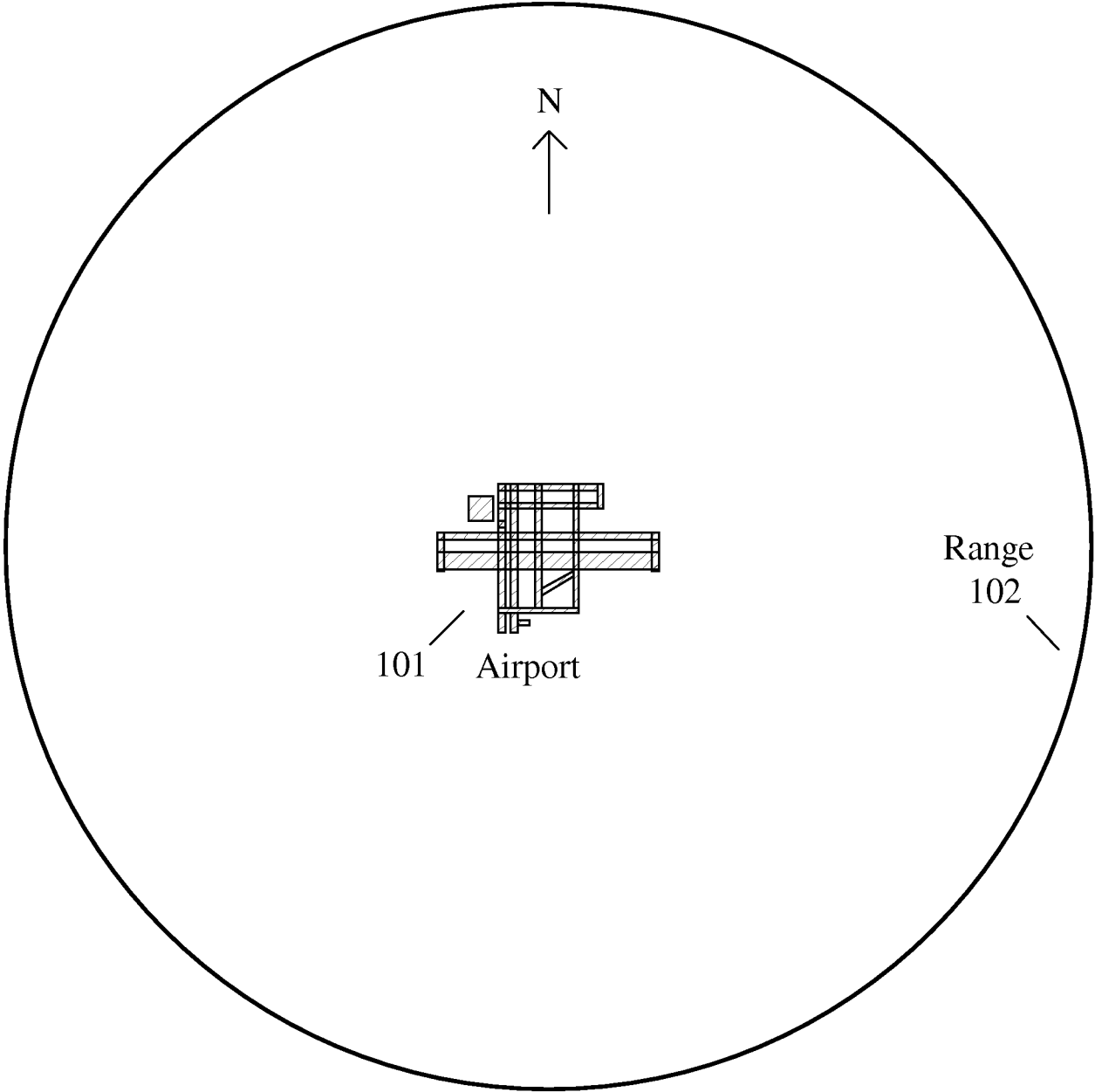

Fig. 1

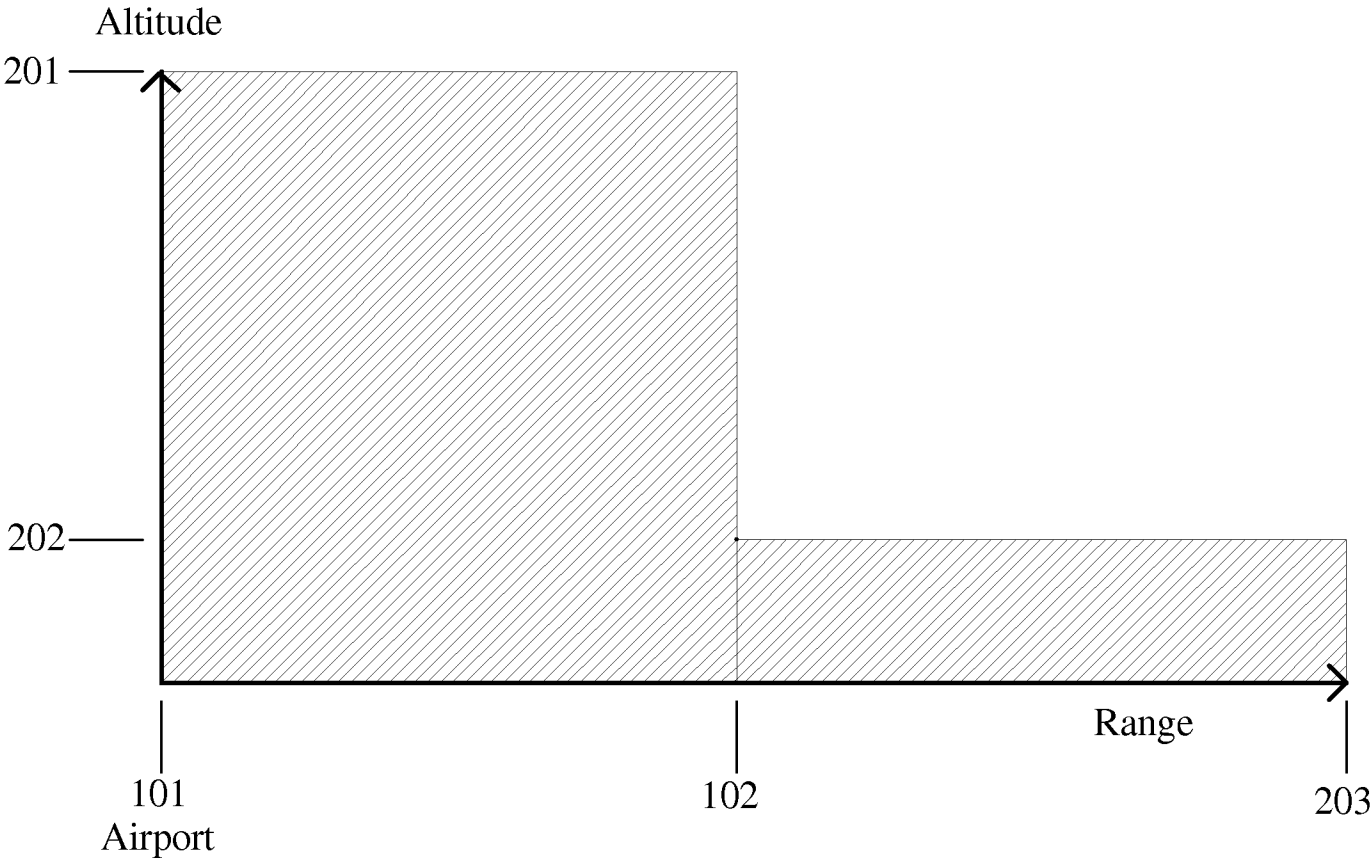

Fig. 2

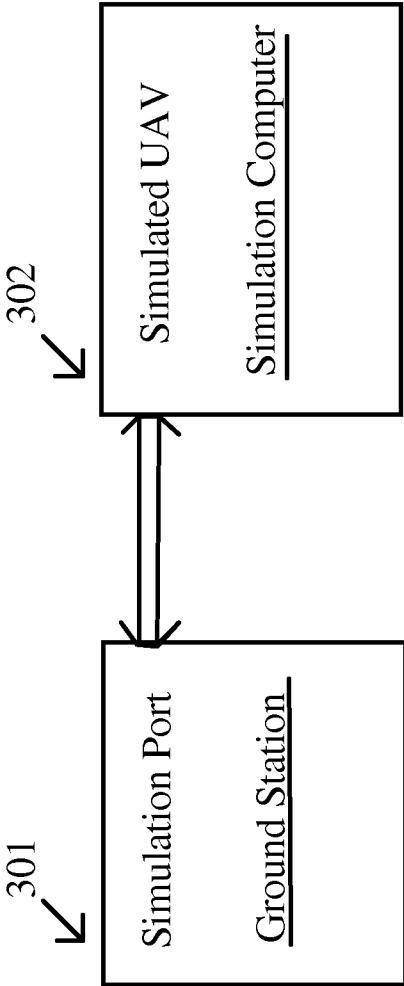

Fig. 3



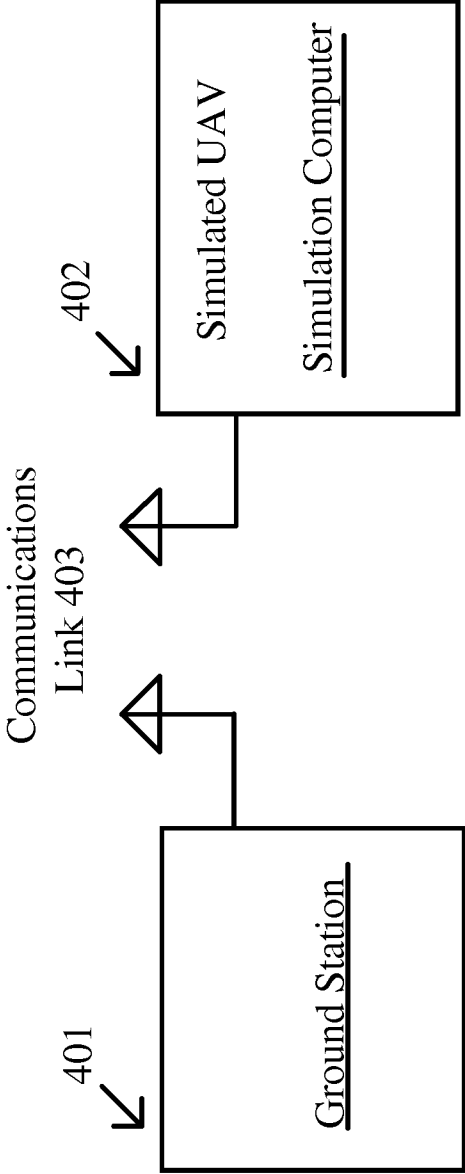

Fig. 4

## Exhibit 2

## Exhibit 2



US005904724A

# United States Patent [19]

[11] Patent Number: **5,904,724**

Margolin

[45] Date of Patent: **May 18, 1999**

## [54] METHOD AND APPARATUS FOR REMOTELY PILOTING AN AIRCRAFT

5,406,286	4/1995	Tran et al.	342/13
5,446,666	8/1995	Bauer	364/434
5,552,983	9/1996	Thornberg et al.	364/424.027
5,581,250	12/1996	Khviliviky	340/961

[76] Inventor: **Jed Margolin**, 3570 Pleasant Echo, San Jose, Calif. 95148

### OTHER PUBLICATIONS

[21] Appl. No.: **08/587,731**

Lyons, J.W., "Some Navigational Concepts for Remotely Piloted Vehicles", AGARD Conference Proceed, n 176, Med. Accur. Low Cost Navig. at Avion, Panel Tec. Meeting, 5-1-5-15, Sep. 1975.

[22] Filed: **Jan. 19, 1996**

"US GeoData Digital Line Graphs", U.S. Dept. of the Interior, U.S. Geol. Surv. Earth Sci. Info Ctr. (Factsheet) Jun. 1993.

[51] Int. Cl.<sup>6</sup> ..... **G06F 165/00; H04N 7/18**

"US GeoData Digital Elevation Models", U.S. Dept. of the Interior, U.S. Geol. Surv. Earth Sci. Info Ctr. (Factsheet) Jun. 1993.

[52] U.S. Cl. .... **701/120; 701/2; 701/24; 244/189; 244/190; 348/114**

Shifrin, Carole A., "Gripen Likely to Fly Again Soon," *Aviation Week & Space Technology*, Aug. 23, 1993, pp. 72-73.

[58] **Field of Search** ..... 364/423.099, 424.012, 364/424.013, 424.021, 424.022, 449.2, 449.7, 460, 439, 424.028; 340/825.69, 825.72, 967, 989, 991, 992, 993; 244/189, 190, 181, 17.13, 3.11, 3.15; 348/42, 51, 113, 114, 117, 123, 143; 382/154; 395/118, 119, 125

### [56] References Cited

*Primary Examiner*—Tan Q. Nguyen  
*Attorney, Agent, or Firm*—Blakely, Sokoloff, Taylor and Zafman LLP

#### U.S. PATENT DOCUMENTS

3,742,495	6/1973	Diamantides	342/64
3,795,909	3/1974	Vehrs, Jr.	343/7
4,218,702	8/1980	Brocard et al.	348/144
4,405,943	9/1983	Kanally	358/133
4,467,429	8/1984	Kendig	343/433
4,660,157	4/1987	Beckwith et al.	345/421
4,739,327	4/1988	Konig et al.	342/26
4,760,396	7/1988	Barney et al.	342/65
4,835,532	5/1989	Fant	382/284
4,855,822	8/1989	Naredra et al.	364/423.099
4,964,598	10/1990	Berejik et al.	244/190
5,015,187	5/1991	Lord	364/462
5,072,396	12/1991	Fitzpatrick et al.	364/450
5,086,396	2/1992	Waruszewski, Jr.	364/454
5,155,683	10/1992	Rahim	364/424.029
5,179,638	1/1993	Dawson et al.	395/125
5,240,207	8/1993	Eiband et al.	364/423.099
5,257,347	10/1993	Busbridge et al.	395/129
5,266,799	11/1993	Steinitz et al.	324/330
5,272,639	12/1993	McGuffin	364/449
5,335,181	8/1994	McGuffin	364/443
5,381,338	1/1995	Wysocki et al.	348/116

### [57] ABSTRACT

A method and apparatus that allows a remote aircraft to be controlled by a remotely located pilot who is presented with a synthesized three-dimensional projected view representing the environment around the remote aircraft. According to one aspect of the invention, a remote aircraft transmits its three-dimensional position and orientation to a remote pilot station. The remote pilot station applies this information to a digital database containing a three dimensional description of the environment around the remote aircraft to present the remote pilot with a three dimensional projected view of this environment. The remote pilot reacts to this view and interacts with the pilot controls, whose signals are transmitted back to the remote aircraft. In addition, the system compensates for the communications delay between the remote aircraft and the remote pilot station by controlling the sensitivity of the pilot controls.

**20 Claims, 7 Drawing Sheets**

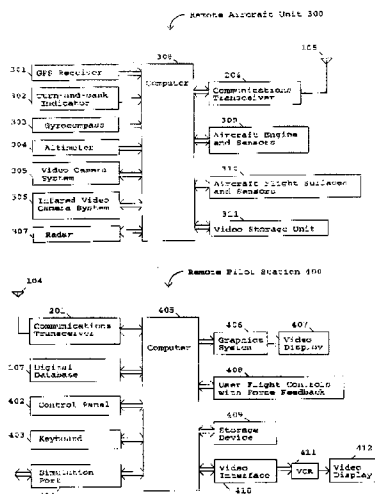

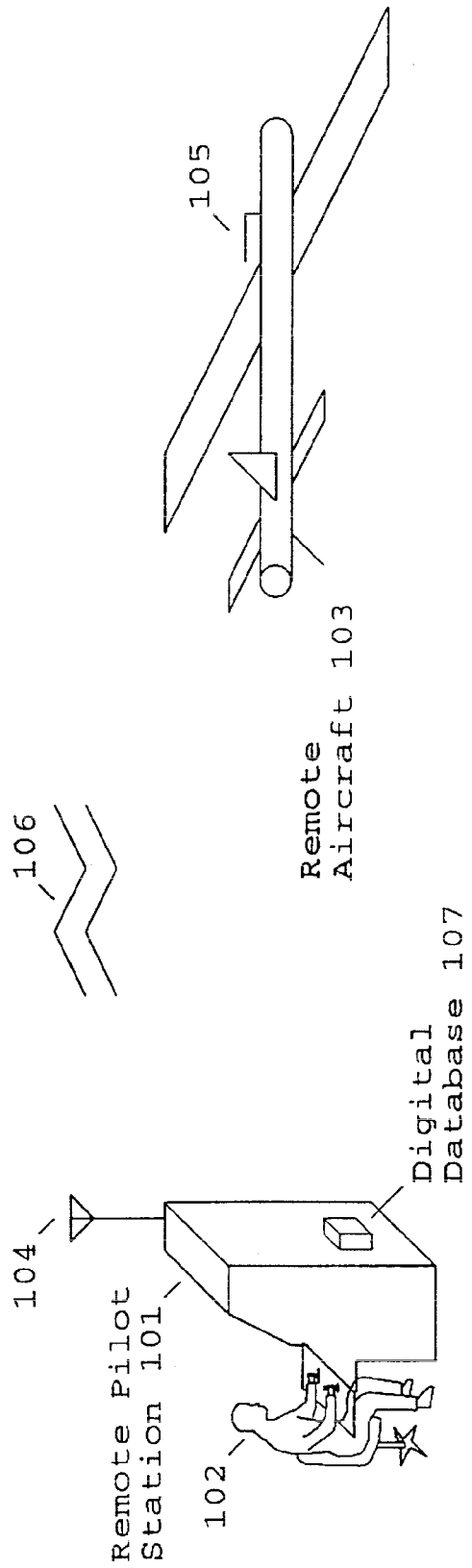

Fig. 1

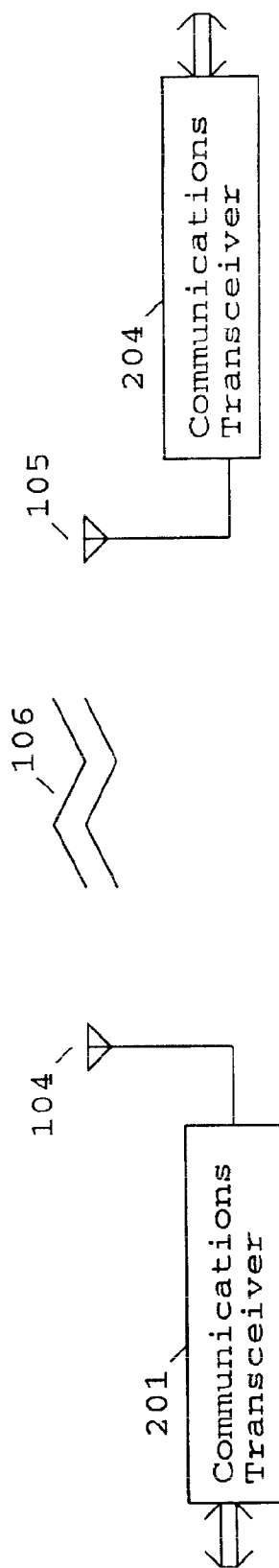

Fig. 2

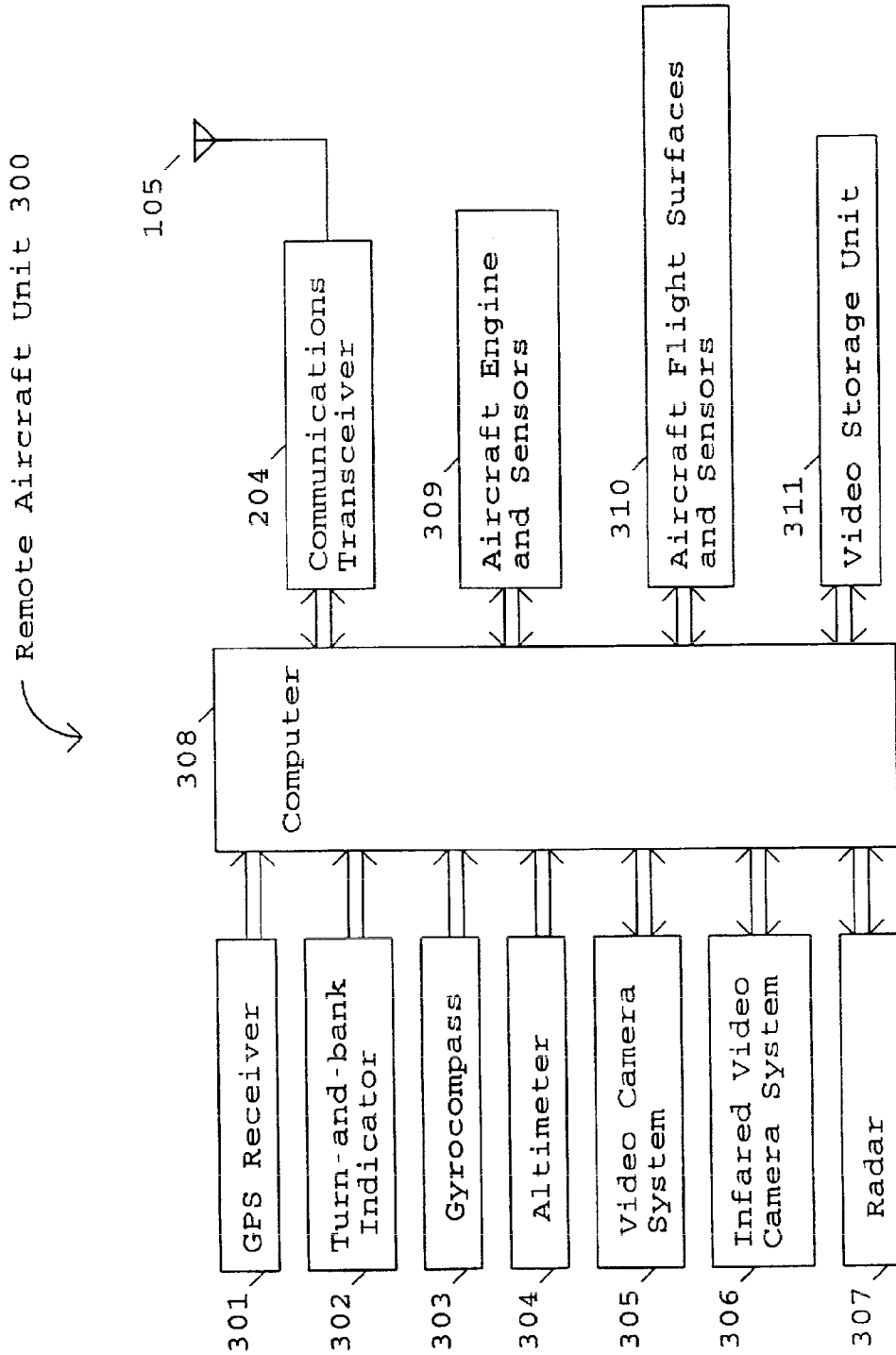

Fig. 3

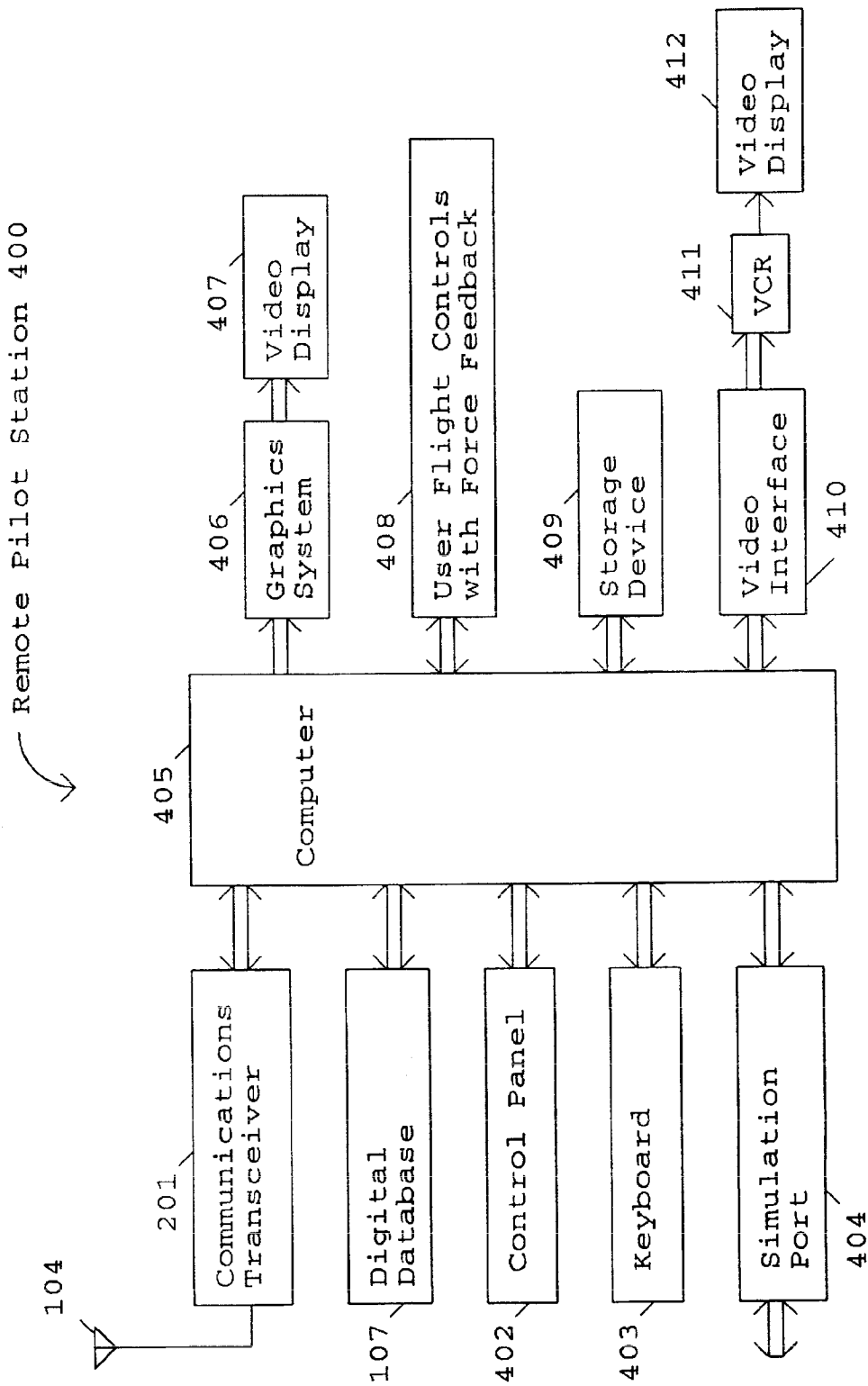

Fig. 4

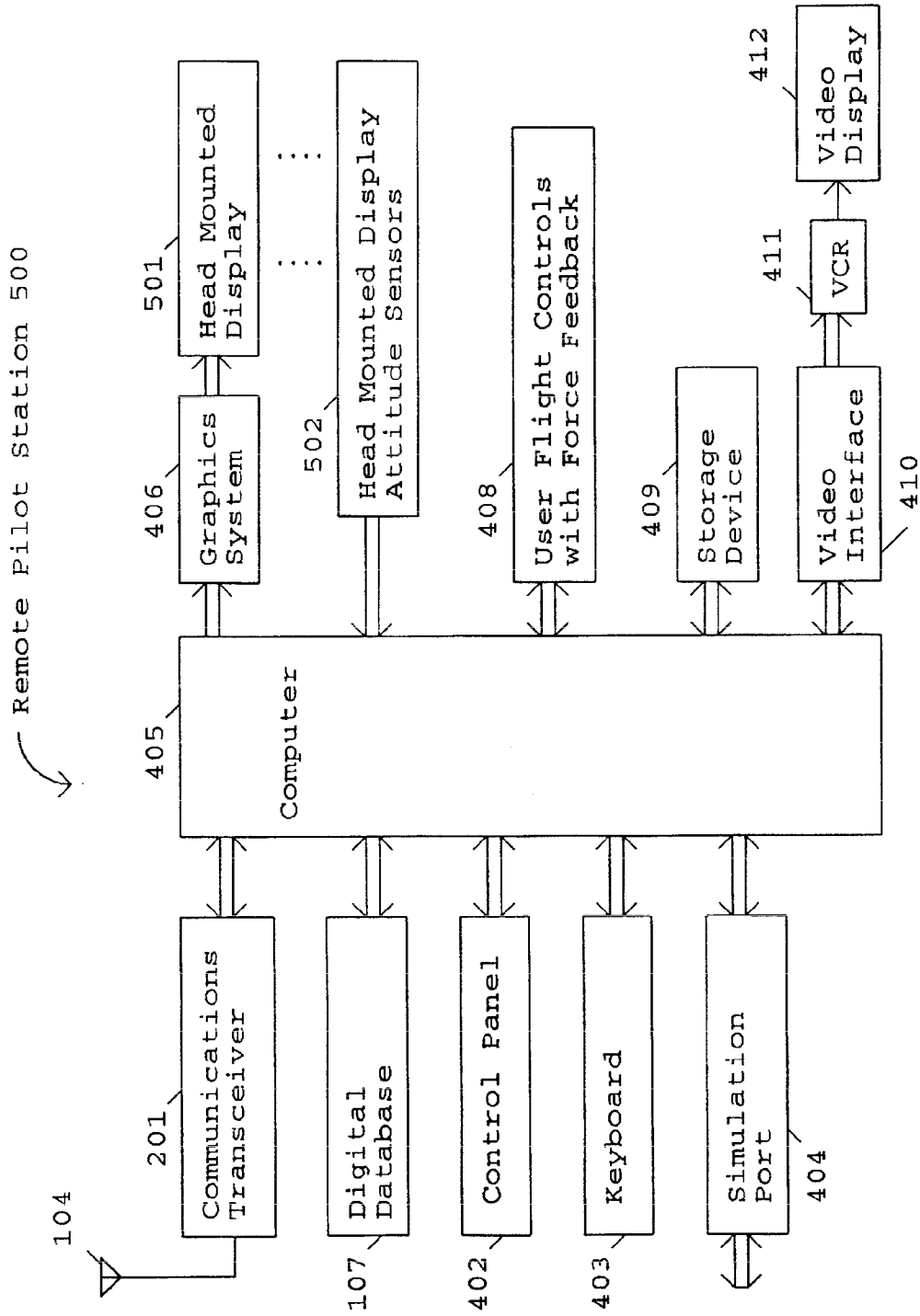

Fig. 5



Remote Aircraft Simulator 600

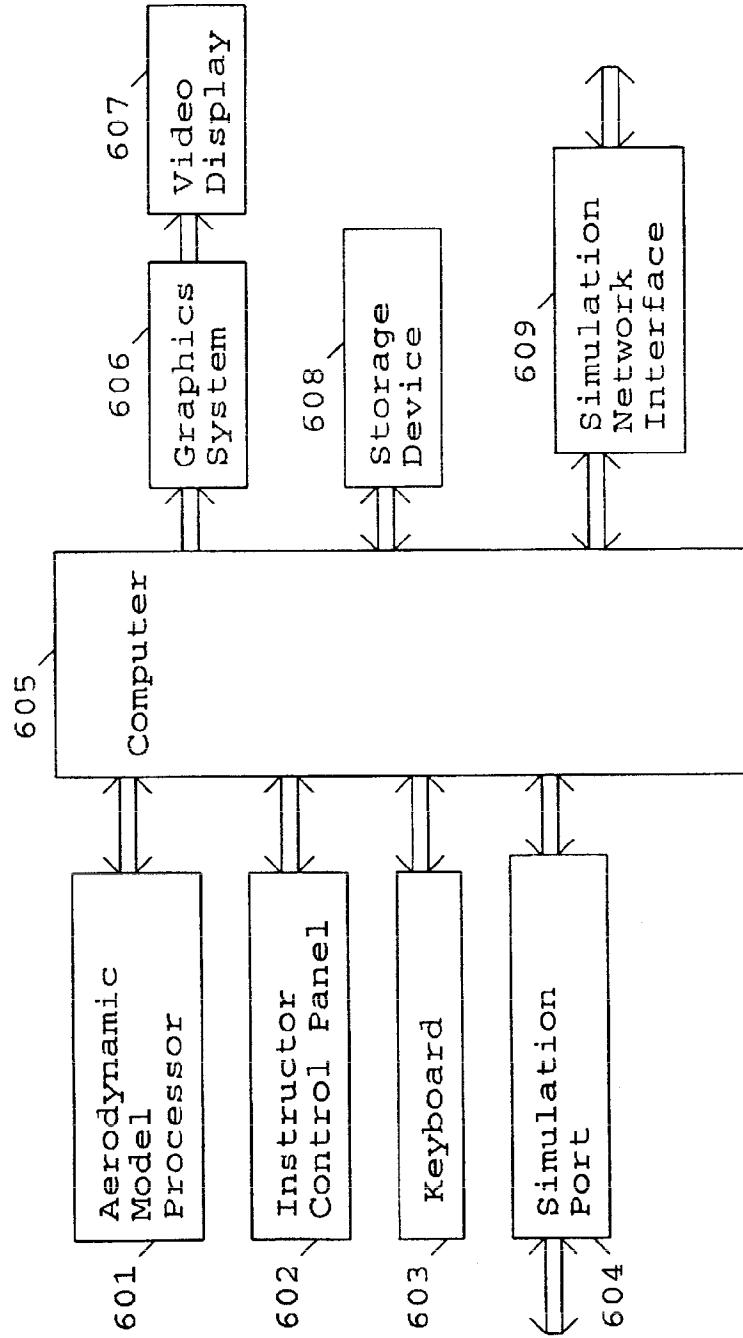

Fig. 6

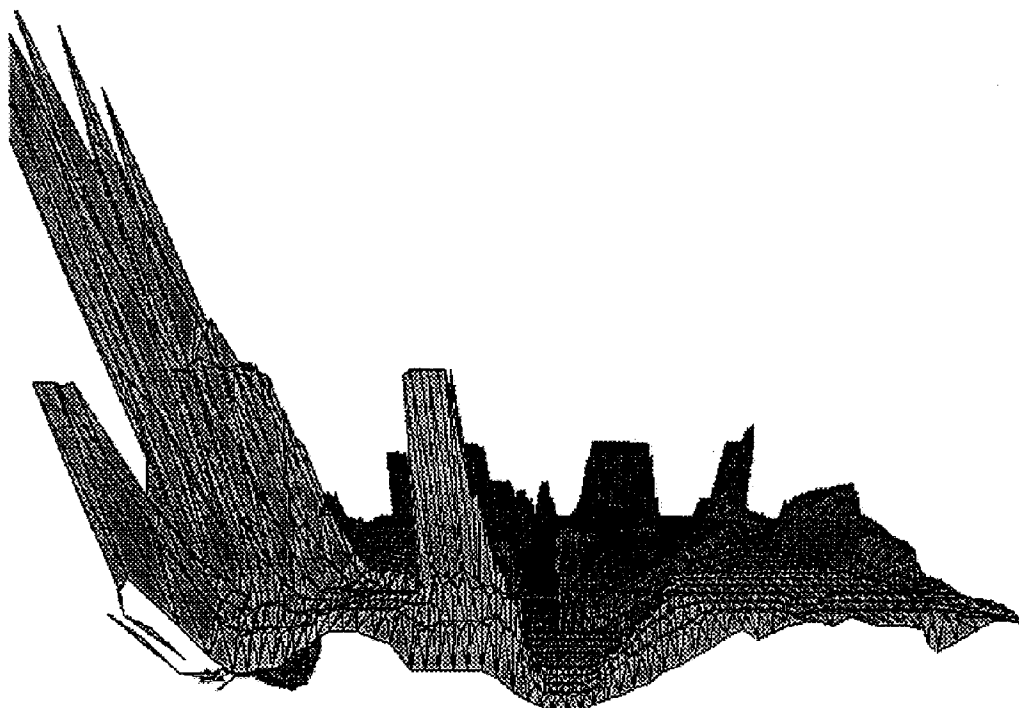

Figure 7

## METHOD AND APPARATUS FOR REMOTELY PILOTING AN AIRCRAFT

### BACKGROUND OF THE INVENTION—CROSS REFERENCES TO RELATED APPLICATIONS

"Pilot Aid Using a Synthetic Environment", Ser. No. 08/274,394 filed Jul. 11, 1994. "Digital Map Generator and Display System", Ser. No. 08/543,590, filed Oct. 16, 1995.

#### 1. Field of Invention

This invention relates to the field of remotely piloted vehicles (RPVs) and unmanned aerial vehicles (UAVs).

#### 2. Discussion of Prior Art

RPVs can be used for any number of purposes. For example, there is a large organization that promotes the use of remote controlled planes. Certain RPVs are controlled by viewing the plane with the naked eye and using a hand held controller to control its flight. Other RPVs are controlled by a remote pilot using simple joysticks while watching the video produced by a camera in the remote aircraft. This camera is also used to produce the reconnaissance video. There are tradeoffs involving the resolution of the video, the rate at which the video is updated, and the bandwidth needed to transmit it. The wider the bandwidth the more difficult it is to secure the signal. The freedom to balance these tradeoffs is limited because this video is also used to pilot the aircraft and must therefore be updated frequently.

Certain UAVs are preprogrammed to follow a predetermined course and lack the flexibility to deal with unexpected situations.

The 1983 patent to Kanaly (U.S. Pat. No. 4,405,943) shows a control and communications system for a remotely piloted vehicle where an oculometer determines where the remote operator is looking and signals the remote vehicle to send the high resolution imagery corresponding to the area around where the remote operator is looking and low resolution imagery corresponding to the remote operator's peripheral vision. The objective is to minimize the bandwidth of the information transmitted to the remote operator.

### SUMMARY

A method and apparatus is described that allows a remote aircraft to be controlled by a remotely located pilot who is presented with a synthesized three-dimensional projected view representing the environment around the remote aircraft. According to one aspect of the invention, a system is used that includes an aircraft and a remote pilot station.

The aircraft uses a communications link to send its location, attitude, and other operating conditions to the remote pilot station. The remote pilot station receives the data and uses a database describing the terrain and manmade structures in the remote aircraft's environment to produce a 3D view of the remote aircraft environment and present it to the remote human pilot.

The remote pilot responds to the information and manipulates the remote flight controls, whose positions and forces are transmitted to the remote aircraft. Since the amount of data is small, it can be readily secured through encryption and spread spectrum techniques.

Also, because the video reconnaissance cameras are no longer needed to remotely pilot the aircraft there is great flexibility in their use. To minimize bandwidth and reduce the possibility of being detected, the video data can be sent at a slow update rate. The data can also be stored on the remote aircraft for later transmission. Alternatively, low resolution pictures can be sent in real-time, while the cor-

responding high resolution pictures can be at a later time. The reconnaissance video can even be transmitted through a different communications link than the control data. There may also be more than one reconnaissance camera.

The delay in the control link must be minimized in order that the remote aircraft can be properly flown. The system can measure the link delay and make this information available to the pilot. This delay link measurement can also be used to modify the control software through which the remote pilot flies the remote aircraft. This is to prevent pilot-induced oscillation.

The computers in the system allow for several modes of operation. For example, the remote aircraft can be instructed to fly to given coordinates without further input from the remote pilot. It also makes it possible to provide computer assistance to the remote pilot. In this mode, the remote flight control controls absolute pitch and roll angles instead pitch and roll rates which is the normal mode for aircraft. In addition, adverse yaw can be automatically corrected so that the resulting control laws make the remote aircraft extremely easy to fly. Because this comes at the expense of being able to put the remote aircraft into unusual attitudes, for complete control of the remote aircraft a standard control mode is provided to give the remote pilot the same type of control that is used to fly a manned aircraft. Since the remote aircraft is unmanned, the remote pilot can subject the remote aircraft to high-G maneuvers that would not be safe for a pilot present in the aircraft.

To facilitate training, a simulated remote aircraft is provided that allows an instructor to set up the training mission and parameters. This is especially useful in giving remote pilots experience flying with different control link delays. In this simulated mode, the system can be further linked to a battlefield simulator such as SIMNET.

In the first embodiment, the remote pilot is provided with a standard video display. Additional display channels can be provided to give the remote pilot a greater field of view. There can even be a display channel to give a rearward facing view.

A second embodiment uses a head mounted display for the remote pilot instead of a standard display. This permits the remote station to be made more compact so that it can be used in a wider variety of installations. An example would be in a manned aircraft flying several hundred miles away.

### BRIEF DESCRIPTION OF THE DRAWINGS

The invention may best be understood by referring to the following description and accompanying drawings which illustrate the invention. In the drawings:

FIG. 1 is a general illustration showing a remote pilot at a remote pilot station operating a remote aircraft according to one embodiment of the invention.

FIG. 2 is a block diagram showing the communications link between a remote pilot station and a remote aircraft according to one embodiment of the invention.

FIG. 3 is a block diagram of a remote aircraft according to one embodiment of the invention.

FIG. 4 is a block diagram of a remote pilot station according to one embodiment of the invention.

FIG. 5 is a block diagram of a remote pilot station according to another embodiment of the invention.

FIG. 6 is a block diagram of a remote aircraft simulator used for training remote pilots according to one embodiment of the invention.

FIG. 7 is an example of a three dimensional projected image presented to a remote pilot by a remote pilot station according to one embodiment of the invention.

## DETAILED DESCRIPTION

In the following description, numerous specific details are set forth to provide a thorough understanding of the invention. However, it is understood that the invention may be practiced without these specific details. In other instances, well-known circuits, structures and techniques have not been shown in detail in order not to obscure the invention.

A method and apparatus is described that allows a remote aircraft to be controlled by a remotely located pilot who is presented with a synthesized three-dimensional projected view representing the environment around the remote aircraft. Since the video from a reconnaissance camera located on the remote aircraft is not used to pilot the remote aircraft, the amount of data transmitted between the remote aircraft and the remote pilot is small. This provides greater flexibility in how the remote aircraft is used and allows the transmitted data to be made more secure. The remote aircraft may be of any type, for example a remote control plane or helicopter as used by recreational enthusiast.

FIG. 1 is a general illustration showing a remote pilot at a remote pilot station operating a remote aircraft according to one embodiment of the invention. FIG. 1 shows Remote Pilot 102 interacting with Remote Pilot Station 101 and controlling Remote Aircraft 103. Remote Pilot Station 101 and Remote Aircraft 103 respectively include an Antenna 104 and an Antenna 105 for communicating Information 106.

In one embodiment, Information 106 includes status information concerning the status of Remote Aircraft 103 and flight control information for controlling the flight of Remote Aircraft 103. The status information is generated by Remote Aircraft 103 and includes the three dimensional position and the orientation (also termed attitude, and comprising heading, roll, pitch) of Remote Aircraft 103. The status information may also include information concerning the flight surfaces, the engine, an additional altitude reading, etc. Remote Pilot Station 101 uses this status information to retrieve data from a Digital Database 107 which contains a three-dimensional description of terrain and manmade structures over which Remote Aircraft 103 is flying. Based on the three dimensional data retrieved from Digital Database 107, Remote Pilot Station 101 projects a synthesized three-dimensional projected view of the terrain and manmade structures in the vicinity of Remote Aircraft 103. Based on this view of the terrain and manmade structures, the Remote Pilot Station 101, on its own and/or in response to input from Remote Pilot 102, generates and transmits flight control information to Remote Aircraft 103 which adjusts its flight accordingly.

In one embodiment, the Remote Aircraft 103 is a remote controlled plane or helicopter used for recreational purposes. Since remote controlled planes and helicopters tend to be small in size, the circuitry in such remote aircraft to generate and receive Information 106 is minimized. In such systems, the Remote Pilot Station 101 may be implemented by including additional attachments to an existing portable computer. This allows the user to easily transport the remote aircraft and pilot station to an appropriate location for flight.

FIG. 2 is a block diagram showing a bi-directional communications link between a remote pilot station and a remote aircraft according to one embodiment of the invention. FIG. 2 shows Communications Transceiver 201 coupled to Antenna 104 of Remote Pilot Station 101, as well as Communications Transceiver 204 coupled to Antenna 105 of Remote Aircraft 103. In addition, FIG. 2 shows Information 106 being communicated between Antenna 104 and Antenna 105.

FIG. 3 is a block diagram of a remote aircraft unit used in the remote aircraft according to one embodiment of the invention. FIG. 3 shows Remote Aircraft Unit 300 including Computer 308 coupled to GPS Receiver 301, Turn-and-bank Indicator 302, Gyrocompass 303, Communications Transceiver 204, Aircraft Engine and Sensors 309, and Aircraft Flight Surfaces and Sensors 310. GPS Receiver 301 receives signals from the satellites that make up the global positioning system (GPS) and calculates the aircraft's position in three dimensions. Turn-and-bank Indicator 302 and Gyrocompass 303 provide the aircraft's orientation which comprises heading, roll, and pitch. This data is sent to Computer 308 for transformation into the previously described status information. Computer 308 transmits this status information to Communications Transceiver 204 which produces a radio signal and supplies it to Antenna 105.

The Aircraft Engine and Sensors 309 are coupled to control the aircraft's engine, while the Aircraft Flight Surfaces and Sensors 310 are coupled to control the aircraft's flight surfaces. The flight control information is received from the remote pilot station by Computer 308 through Antenna 105 and Communications Transceiver 204. This flight control information is processed by Computer 308 into the necessary signals for transmission to Aircraft Engine and Sensors 309 and Aircraft Flight Surfaces and Sensors 310 to control the aircraft's engine and flight surfaces, respectively. The operation of the aircraft's flight control surfaces will be later described with reference to FIG. 4.

In order to protect against ECM, the communications link between the Remote Pilot Station 101 and the Remote Aircraft 103 may be secured. While any number of different techniques may be used to secure this link, in one embodiment Computer 308 is implemented to encrypt/decrypt the data transmitted and Communications Transceiver 204 is implemented to use spread spectrum techniques.

Computer 308 may optionally be coupled to Altimeter 304, Video Camera System 305, Infrared Video Camera System 306, Radar 307, and/or Video Storage Unit 311. Altimeter 304 provides an output of the aircraft's altitude as a safety check in the event GPS Receiver 301 malfunctions. Thus, this additional altitude reading may also be transmitted to Remote Pilot Station 101 as part of the status information.

Video Camera System 305 is controlled by Computer 308 which determines where the camera is pointing as well as focusing and the zoom factor. The video produced by the camera is not used by the remote pilot for flying the remote aircraft, so there is more flexibility in using the video. As a result, any number of techniques can be used for receiving the images captured by Video Camera System 305. As examples:

1. High resolution, high update images may be sent back in real-time through the Communications Link, when the high bandwidth needed can be tolerated.
2. High resolution, low update images may be sent back in real-time through the Communications Link to reduce the bandwidth.
3. The video may be recorded in Video Storage Unit 311 for later transmission.
4. The video may be transmitted through a separate communications link.
5. There may be multiple video cameras.

Infrared Video Camera System 306 is similar to Video Camera System 305 and has the same operating modes.

Radar 307 in Remote Aircraft 103 may be passive or active. It may scan a particular pattern or it may track a

selected object. Radar 307 may consist of several Radar units. The information from Radar 307 is processed by Computer 308 so that only the desired information is transmitted over the communication link to the Remote Pilot Station 101 for display.

FIG. 4 is a block diagram of a remote pilot station according to one embodiment of the invention. FIG. 4 shows a Remote Pilot Station 400 including a Computer 405 coupled to Communications Transceiver 201, Digital Database 107, Graphics System 406, User Flight Controls with Force Feedback 408, and a Storage Device 409. The Storage Device 409 represents one or more mechanisms for storing data. For example, the Storage Device 409 may include read only memory (ROM), random access memory (RAM), magnetic disk storage mediums, optical storage mediums, flash memory devices, and/or other machine-readable mediums. Of course, Digital Database 107 may be stored in one or more machine-readable mediums and/or in Storage Device 409.

As previously described, Antenna 104 receives the radio signals transmitted by Remote Aircraft 103 representing the status information of Remote Aircraft 103. These radio signals are transformed by Communications Transceiver 201 and sent to Computer 405. Communications Transceiver 201 is set to the same mode as Communications Transceiver 204, so that if, for example, spread spectrum techniques are used, the signal will be transparently received. Computer 405 recovers the data (de-encrypting, if required) so that the data communications from Computer 308 in the Remote Aircraft to Computer 405 in the Remote Pilot Station is transparent. Thus, the bi-directional communications link comprises the combination of Communications Transceiver 201, Antenna 104, Antenna 105, and Communications Transceiver 204.

As previously described, the status information received by Computer 405 includes the three dimensional position and the orientation of Remote Aircraft 103. The status information may also include information concerning the flight surfaces, flight sensors, the engine, an additional altitude reading, etc. Computer 405 uses this status information to retrieve data from Digital Database 107 which contains a three-dimensional description of terrain and man-made structures over which Remote Aircraft 103 is flying. The composition and creation of the Digital Database 107 is further described later. Based on the three dimensional data retrieved from Digital Database 107, Computer 405 performs the mathematical operations to transform and project the three dimensional data to generate video data representing a synthesized three-dimensional projected view of the terrain (and, if desired, manmade structures) in the vicinity or environment of Remote Aircraft 103. This video data is transmitted to Graphics System 406, which displays the synthesized three-dimensional projected view on Video Display 407.

Since the image is generated from the digital database, virtually any image of the environment of the Remote Aircraft 103 can be generated. As examples, the pilot may select the environment to be: 1) a simulated image of what would be seen out of the cockpit of a manned aircraft on a similar flight path; 2) a simulated image of what would be seen when looking in any direction (e.g., backwards, out a side window, etc.); 3) a simulated image of what would be seen if a camera were tailing the remotely piloted aircraft; etc. In addition, the simulated image may be set to any magnification. Thus, the phrase environment of Remote Aircraft 103 is intended to include any image generated with reference to the remote aircraft's position.

The User Flight controls with Force Feedback 408 are used by the remote pilot to input flight path information. The User Flight Controls may be of any number of different types, some of which are further described later herein. The status information received by Computer 405 also includes information received from Aircraft Flight Surfaces and Sensors 310. This information is used to actuate force feedback circuitry in User Flight Controls With Force Feedback 408. Remote Pilot 102 observes the synthesized three-dimensional environment displayed on Video Display 407, feels the forces on User Flight Controls With Force Feedback 408 and moves the controls accordingly. This flight control information is sent through the communications link, to Computer 308, and is used to control the aircraft flight surfaces in Aircraft Flight Surfaces and Sensors 310. Remote Pilot 102 also receives data from Aircraft Engine and Sensors 309 through the communications link and is able to send data back to control the engine.

#### Flight Control

To illustrate the operation of the remote aircraft, a fixed-wing airplane will be described as an example. However, the basic principles apply to other types of aircraft as well. The basic control surfaces of an airplane consist of the ailerons, the horizontal elevators, and the rudder. The ailerons are moved differentially (one up, one down) to rotate the airplane around its roll axis; the horizontal elevators cause the airplane to rotate around its pitch axis; and the rudder causes the airplane to rotate around its yaw axis.

When the ailerons are used to modify the lift characteristics of the wings, one wing creates more lift while the other wing creates less lift. This also changes the drag characteristics of the wings and results in a yaw force that is opposite to the yaw force that results from the tail section causing the airplane to weather-cock into the relative wind. It is this yaw force caused by the airplane weather-cocking into the relative wind that causes a banked airplane to turn. The opposite yaw force produced by using the ailerons is called adverse yaw; the rudder control is used to counteract this force to produce a coordinated turn.

The simplest type of flight control consists of a joystick and a set of rudder pedals. The controls are directly connected to the flight control surfaces. With a joystick, moving the stick left and right moves the ailerons, while moving the stick forward and backward moves the horizontal elevators. The rudder is controlled by two foot pedals, one for each foot, that are mounted on a common shaft and hinged in the middle like a seesaw. Pressing one foot pedal forward causes the other foot pedal to move backward and causes the rudder to also move in one direction. Pressing the other foot pedal causes it to move forward and the opposite pedal to move backward and causes the rudder to move in the opposite direction.

An alternative to the joystick is the control yoke which consists of a wheel attached to a shaft that moves in and out of the control housing. Turning the wheel clockwise or counterclockwise moves the ailerons; moving the wheel shaft in and out moves the horizontal elevators. The rudder pedals as the same as those used with a joystick.

In order to aid in a description of remote aircraft operation, it is thought worthwhile to first describe the operation of non-remotely piloted vehicles. Non-remotely piloted vehicles can be operated in one of two ways (also termed as flight control modes); direct control or computer control (also termed as computer mediated).

#### Direct Control Non-Remotely Piloted Vehicles

When the flight controls are connected directly to the control surfaces the result is a second order system. Using

the joystick as an example, moving the joystick left or right establishes a roll rate. The airplane continues to roll until the joystick is returned to the center position, after which the airplane remains in the bank angle thus established. The foot pedals are used to counteract the adverse yaw as previously described. Moving the joystick forward or backward establishes a pitch rate. The airplane continues to pitch until the joystick is returned to the center position, after which the airplane remains in the pitch angle thus established. Both the roll rate and the pitch rate are subject to the limits of the airplane's design.

Since the joystick is directly connected to the control surfaces, the aerodynamic forces on the control surfaces are transmitted back to the pilot, giving him or her valuable feedback on how the airplane is flying.

The successful operation of the second order system with the pilot in the loop depends on several factors such as the area and placement of the control surfaces, how much the control surfaces move in response to the movement of the pilot controls, and how long the airplane takes to respond to changes of the control surfaces. The total system characteristics also depend on the reaction time of the pilot. If the resulting system is poorly designed it may be unstable, which means it may not be possible for a human pilot to fly it safely. An example of an unstable system is where the pilot desires to perform a gentle roll to the right and so moves the joystick to the right, the airplane's roll rate is faster than the pilot desires so he/she attempts to compensate by moving the joystick to the left, the airplane rolls left at a rate that is faster than the pilot desires so he/she moves the joystick to the right, and so on, with the pilot constantly overcorrecting and with the aircraft's rolling motions constantly getting larger and larger until the aircraft gets into a condition from which it may not be possible to recover, (e.g., spinning into the ground). The type of loss of control described is usually referred to as 'pilot induced oscillation' and although it may be caused by an inexperienced or inattentive pilot, it is more often caused by poor airplane design. Therefore, new airplane designs are extensively tested to make sure they can be safely flown. Examples of airplanes that use direct control of the control surfaces (Direct Control Second Order Systems) are the Cessna 150 and the Piper Cub.

#### Computer Mediated Non-Remotely Piloted Vehicles

Computer mediated control systems use a computer between the pilot controls and the control surfaces. The pilot controls are read by the computer, the data are modified in a particular way, and the computer sends control signals to the control surfaces. The computer may also sense the forces on the control surface and use it to control force feedback to the pilot controls. This type of computer mediated control may be used to fly an airplane that would otherwise be unstable, such as the F16 or the F117. Aircraft such as the F16 and F117 are also second order systems because the position of the pilot's joystick represents rate of rotation.

There are risks inherent in a computer mediated system. Although the program can be simulated extensively before using it in an actual airplane, the computer program may be quite large and therefore difficult to simulate under all possible conditions. An example of this is the Swedish JAS 39 Gripen Fighter. Despite extensive simulation of the flight control system, during a test flight a Gripen crashed due to "... the flight control system's high amplification of stick commands combined with the pilot's" large, rapid stick movements". The pilot had entered a low-speed high-banked turn at a 280 meter altitude with lit afterburners and

was leaving the turn when his actions led to 'pilot-induced oscillation'. (Aviation Week & Space Technology, Aug. 23, 1993, pages 72-73).

Having described techniques for operating non-remotely piloted vehicles, the Fight Control Modes for RPVs will be described.

#### Second Order RPV Flight Control Mode

A second order control system for an RPV is inherently computer mediated because the remote pilot must interact through two computers: the computer in the remote aircraft and the computer in the remote pilot station.

Flying an RPV is further complicated because there are additional time delays in the loop. The computer in the remote aircraft must first determine the aircraft's position and orientation. The additional processing for transmitting a secure signal by encryption and/or spread spectrum techniques may create additional delays. Transmission delay of signals between the remote aircraft and remote pilot station is negligible for a direct path. However, if the signals are relayed through other facilities the delay time may be appreciable, especially if an orbiting satellite is used. There are additional delays in the remote pilot station as the remote aircraft's position and orientation are used to transform the data from the digital database to present the pilot with the synthesized 3D projected view from the remote aircraft. In one embodiment, the RPV system measures the various delays and modifies the control laws used by the computer in the remote pilot aircraft and in the feedback provided by the computer in the remote pilot station to the remote pilot. For example, the computer may adjust the sensitivity of the User Flight Controls 408 according to the delay (e.g., as the delay increases, the computer will decrease the sensitivity of the flight controls). The system also displays the measured delay to the remote pilot.

#### First Order RPV Flight Control Mode

The stability of the flight control system, and thus the flyability of an RPV, can be improved considerably by using a first order system. In one embodiment of such a first order system the position of the remote pilot's joystick represents an angle relative to the horizon, instead of representing a rate of rotation as in a second order system. The position of the joystick is transmitted to the computer in the remote aircraft which moves the control surfaces as required to place the remote aircraft in the requested orientation. The control system in the remote aircraft is still a second order system but the delays in the communications link and the remote pilot station are no longer a part of the system's loop.

When a joystick is centered, the remote aircraft will fly straight and level. When the joystick is to the right of center the remote aircraft will be in a right banked turn. When the joystick is to the left of center the remote aircraft will be in a left banked turn. When the joystick is backward from center the remote aircraft will be in a pitch up orientation. When the joystick is forward of center the remote aircraft will be in a pitch down orientation.

The amount of bank and pitch permitted depends on the design of the remote aircraft. A high performance remote aircraft will be capable of a greater amount of pitch and bank than will a low performance remote aircraft.

Referring again to FIG. 4, Computer 405 may optionally be coupled to Control Panel 402, Keyboard 403, Simulation Port 404, Video Interface 410, VCR 411, and/or Video Display 412. In one embodiment, Control Panel 402 con-

tains specialized lights, displays, and switches to allow a quicker response to situations than can be provided by Keyboard 403. Control Panel 402 can be arranged to approximate the look and feel of an actual aircraft cockpit. Keyboard 403 allows the remote pilot to select various operating modes. For training purposes, Simulation Port 404 allows the remote pilot station to be connected to a remote aircraft simulator instead of an actual remote aircraft. The remote aircraft simulator will be further described with reference to FIG. 6. Storage Device 409 allows the flight data to be recorded. During playback this previously recorded data is substituted for real-time data from the remote aircraft to replay the mission for analysis. Any video received from any reconnaissance cameras on the Remote Aircraft 103 is converted by Video Interface 410 so that it can be recorded on VCR 411 and displayed on Video Display 412. VCR 411 can also operate in straight-through mode so that the reconnaissance video can be viewed in real time.

FIG. 5 is a block diagram of a remote pilot station according to another embodiment of the invention. FIG. 5 shows Remote Pilot Station 500. Remote Pilot Station 500 is similar to Remote Pilot Station 400 of FIG. 4, except Video Display 407 is replaced by Head Mounted Display 501. In addition, Head Mounted Display Attitude Sensors 502 are coupled to Computer 405. Head Mounted Display Attitude Sensors 502 measure the attitude of Head Mounted Display 501. This information is used by Computer 405 to produce an additional three dimensional transformation of the data from Digital Database 107 to account for the attitude of the remote pilots Head Mounted Display 501. This does not require any additional data from the remote aircraft. Of course, alternative embodiments could include both a video display and a head mounted display.

FIG. 6 is a block diagram of a simulated remote aircraft used for training remote pilots according to one embodiment of the invention. FIG. 6 shows Remote Aircraft Simulator 600 including Computer 605 coupled to Aerodynamic Model Processor 601, Instructor Control Panel 602, Keyboard 603, Simulation Port 604, Graphics System 606, Storage Device 608, and Simulation Network Interface 609. Remote Aircraft Simulator 600 communicates with Remote Pilot Station 400 or 500 through Simulation Port 604. Aerodynamic Model Processor 601 executes a mathematical model that simulates the behavior of a remote aircraft. An instructor uses Instructor Control Panel 602 and Keyboard 603 to select various training scenarios. Graphics System 606 and Video Display 607 are used to observe the operation of the system. Storage Device 608 is used to record the training session for later evaluation of the session. In addition to proficiency training, the Remote Aircraft Simulator can also be used to practice a proposed mission. The data communicated to the remote pilot station can include training and evaluation data for processing and/or display. This training and evaluation data can include any relevant information, such as flight path accuracy, etc.

Simulation Network Interface 609 permits participation in a battlefield simulation system such as SIMNET, mixing aircraft, tanks, and ground troops for training in the coordination of mixed forces. Thus, the system is designed to allow for the communication of this battlefield simulation information between the remote aircraft simulator and the remote pilot station. This allows the remote pilot station to display one or more other simulated entities (e.g., tanks, ground troops, other aircraft, etc.) described by the battlefield simulation information.

#### The Database

The Digital Database 107 can be comprised of any type of data from which a three dimensional image can be gener-

ated. For example, the U.S. Geological Survey (USGS) makes available various databases, two of which are of particular interest. The first is the Digital Elevation Model data which consist of an array of regularly spaced terrain elevations.

The other USGS database is the Digital Line Graph data which includes: political and administrative boundaries; hydrography consisting of all flowing water, standing water, and wetlands; major transportation systems consisting of roads and trails, railroads, pipelines, transmission lines, and airports; and significant manmade structures. The Digital Line Graph data is two-dimensional. In the present invention features such as water, roads, railroads, and pipelines are represented as polygons with elevations determined from the Digital Elevation Model data. Transmission lines and significant manmade structures are defined as three-dimensional objects made of polygons and are placed according to the elevations determined from the Digital Elevation Model data. The different types of objects are tagged so that the remote pilot can select them to be highlighted by category or by specific object.

Data from additional digital databases can also be incorporated. An example of such a database is from Jeppesen Sanderson whose NavData Services division provides aeronautical charts and makes this information available in digital form.

The procedure for generating the synthesized three-dimensional view from the Digital Database may use any number of techniques, including those disclosed in the 1987 patent to Beckwith et al. (U.S. Pat. No. 4,660,157 REAL TIME VIDEO PERSPECTIVE DIGITAL MAP DISPLAY METHOD), and the 1993 patent to Dawson et al. (U.S. Pat. No. 5,179,638 METHOD AND APPARATUS FOR GENERATING A TEXTURE MAPPED PERSPECTIVE VIEW). One disadvantage of generating the synthesized three-dimensional view from these elevation databases in real time is the amount of storage space they require. To avoid this large amount of data storage, one embodiment of Digital Database 107 is composed of terrain data that represents the real terrain using polygons. This database may be generated using any number of techniques. For example, this database may be generated by transforming one or more elevation databases into a polygon database using the technique taught in "Pilot Aid Using a Synthetic Environment", Ser. No. 08/274,394 filed Jul. 11, 1994. Another method for transforming one or more elevation databases into a polygon database is taught in "Digital Map Generator and Display System", Ser. No. 08/543,590, filed Oct. 16, 1995. An example of a three dimensional projected image created from this database is shown in FIG. 7.

While the invention has been described in terms of several embodiments, those skilled in the art will recognize that the invention is not limited to the embodiments described. The method and apparatus of the invention can be practiced with modification and alteration within the spirit and scope of the appended claims. The description is thus to be regarded as illustrative instead of limiting on the invention.

What is claimed is:

1. A system comprising:

- a remotely piloted aircraft including,
  - a position determining system to locate said remotely piloted aircraft's position in three dimensions; and
  - an orientation determining system for determining said remotely piloted aircraft's orientation in three dimensional space;
- a communications system for communicating flight data between a computer and said remotely piloted aircraft,

11

said flight data including said remotely piloted aircraft's position and orientation, said flight data also including flight control information for controlling said remotely piloted aircraft;

a digital database comprising terrain data;

said computer to access said terrain data according to said remotely piloted aircraft's position and to transform said terrain data to provide three dimensional projected image data according to said remotely piloted aircraft's orientation;

a display for displaying said three dimensional projected image data; and

a set of one or more remote flight controls coupled to said computer for inputting said flight control information, wherein said computer is also for determining a delay time for communicating said flight data between said computer and said remotely piloted aircraft, and wherein said computer adjusts the sensitivity of said set of one or more remote flight controls based on said delay time.

2. The system of claim 1, wherein:

said remotely piloted aircraft includes a device for capturing image data; and

said system operates in at least a first mode in which said image data is not transmitted from said remotely piloted aircraft to said computer at a sufficient data rate to allow for real time piloting of the remotely piloted aircraft.

3. The system of claim 1, wherein the flight data communicated between said remotely piloted aircraft and said computer is secured.

4. The system of claim 1, wherein said remotely piloted aircraft further comprises a set of one or more video cameras.

5. The system of claim 4, wherein said communications system is also for communicating video data representing images captured by said set of one or more video cameras, said video data for displaying said images.

6. The system of claim 5, wherein said video data is transmitted on a different communication link than said flight data.

7. The system of claim 4, wherein at least one camera in said set of one or more video cameras is an infrared camera.

8. The system of claim 1, wherein said display is a head mounted display.

9. The system of claim 1, wherein said set of one or more remote flight controls is responsive to manual manipulations.

10. The system of claim 1, wherein said set of one or more remote flight controls allows for inputting absolute pitch and roll angles instead of pitch and roll rates.

11. The system of claim 1, wherein said computer is also used for correcting adverse yaw without requiring input from said set of one or more remote flight controls.

12

12. The system of claim 1, wherein:

said remotely piloted aircraft includes a device for capturing image data; and said system operates in at least a first mode in which said image data is not transmitted from said remotely piloted craft to said computer but stored in said remotely piloted aircraft.

13. A station for flying a remotely piloted aircraft that is real or simulated comprising:

a database comprising terrain data;

a set of remote flight controls for inputting flight control information;

a computer having a communications unit configured to receive status information identifying said remotely piloted aircraft's position and orientation in three dimensional space, said computer configured to access said terrain data according to said status information and configured to transform said terrain data to provide three dimensional projected image data representing said remotely piloted aircraft's environment, said computer coupled to said set of remote flight controls and said communications unit for transmitting said flight control information to control said remotely piloted aircraft, said computer also to determine a delay time for communicating said flight control information between said computer and said remotely piloted aircraft, and said computer to adjust the sensitivity of said set of remote flight controls based on said delay time; and

a display configured to display said three dimensional projected image data.

14. The station of claim 13, wherein said communications unit is also configured to receive video data representing images captured by a set of video cameras on said remotely piloted aircraft, said video data for displaying said images.

15. The station of claim 14, wherein said video data is transmitted on a different communication link that said flight control information and said status information.

16. The station of claim 13, wherein said display is a head mounted display.

17. The station of claim 13, wherein said set of remote flight controls is responsive to manual manipulations.

18. The station of claim 13, wherein said set of remote flight controls are configured to allow inputting absolute pitch and roll angles instead of pitch and roll rates.

19. The station of claim 13, wherein said computer is also configured to correct adverse yaw without requiring input from said set of remote flight controls.

20. The station of claim 13, wherein said communications unit includes at least one of a communications transceiver and a simulation port.

\* \* \* \* \*



# Exhibit 3

# Exhibit 3



# UNITED STATES PATENT AND TRADEMARK OFFICE

UNITED STATES DEPARTMENT OF COMMERCE  
United States Patent and Trademark Office  
Address: COMMISSIONER FOR PATENTS  
P.O. Box 1450  
Alexandria, Virginia 22313-1450  
www.uspto.gov

APPLICATION NO.	FILING DATE	FIRST NAMED INVENTOR	ATTORNEY DOCKET NO.	CONFIRMATION NO.
11/736,356	04/17/2007	Jed Margolin		3649

23497 7590 09/01/2010  
JED MARGOLIN  
1981 EMPIRE ROAD  
RENO, NV 89521-7430

EXAMINER
----------

MANCHO, RONNIE M

ART UNIT	PAPER NUMBER
----------	--------------

3664

MAIL DATE	DELIVERY MODE
-----------	---------------

09/01/2010

PAPER

**Please find below and/or attached an Office communication concerning this application or proceeding.**

The time period for reply, if any, is set in the attached communication.

<b>Office Action Summary</b>	<b>Application No.</b> 11/736,356	<b>Applicant(s)</b> MARGOLIN, JED	
	<b>Examiner</b> RONNIE MANCHO	<b>Art Unit</b> 3664	

-- The MAILING DATE of this communication appears on the cover sheet with the correspondence address --

**Period for Reply**

A SHORTENED STATUTORY PERIOD FOR REPLY IS SET TO EXPIRE 3 MONTH(S) OR THIRTY (30) DAYS, WHICHEVER IS LONGER, FROM THE MAILING DATE OF THIS COMMUNICATION.

- Extensions of time may be available under the provisions of 37 CFR 1.136(a). In no event, however, may a reply be timely filed after SIX (6) MONTHS from the mailing date of this communication.
- If NO period for reply is specified above, the maximum statutory period will apply and will expire SIX (6) MONTHS from the mailing date of this communication.
- Failure to reply within the set or extended period for reply will, by statute, cause the application to become ABANDONED (35 U.S.C. § 133). Any reply received by the Office later than three months after the mailing date of this communication, even if timely filed, may reduce any earned patent term adjustment. See 37 CFR 1.704(b).

**Status**

- 1)  Responsive to communication(s) filed on 17 April 2007.
- 2a)  This action is **FINAL**.
- 2b)  This action is non-final.
- 3)  Since this application is in condition for allowance except for formal matters, prosecution as to the merits is closed in accordance with the practice under *Ex parte Quayle*, 1935 C.D. 11, 453 O.G. 213.

**Disposition of Claims**

- 4)  Claim(s) 1-14 is/are pending in the application.
  - 4a) Of the above claim(s) \_\_\_\_\_ is/are withdrawn from consideration.
- 5)  Claim(s) \_\_\_\_\_ is/are allowed.
- 6)  Claim(s) 1-14 is/are rejected.
- 7)  Claim(s) \_\_\_\_\_ is/are objected to.
- 8)  Claim(s) \_\_\_\_\_ are subject to restriction and/or election requirement.

**Application Papers**

- 9)  The specification is objected to by the Examiner.
- 10)  The drawing(s) filed on \_\_\_\_\_ is/are: a)  accepted or b)  objected to by the Examiner.
  - Applicant may not request that any objection to the drawing(s) be held in abeyance. See 37 CFR 1.85(a).
  - Replacement drawing sheet(s) including the correction is required if the drawing(s) is objected to. See 37 CFR 1.121(d).
- 11)  The oath or declaration is objected to by the Examiner. Note the attached Office Action or form PTO-152.

**Priority under 35 U.S.C. § 119**

- 12)  Acknowledgment is made of a claim for foreign priority under 35 U.S.C. § 119(a)-(d) or (f).
  - a)  All    b)  Some \*    c)  None of:
  - 1.  Certified copies of the priority documents have been received.
  - 2.  Certified copies of the priority documents have been received in Application No. \_\_\_\_\_.
  - 3.  Copies of the certified copies of the priority documents have been received in this National Stage application from the International Bureau (PCT Rule 17.2(a)).

\* See the attached detailed Office action for a list of the certified copies not received.

**Attachment(s)**

- 1)  Notice of References Cited (PTO-892)
- 2)  Notice of Draftperson's Patent Drawing Review (PTO-948)
- 3)  Information Disclosure Statement(s) (PTO/SB/08)  
Paper No(s)/Mail Date 4/2007.
- 4)  Interview Summary (PTO-413)  
Paper No(s)/Mail Date. \_\_\_\_\_.
- 5)  Notice of Informal Patent Application
- 6)  Other: \_\_\_\_\_.

Art Unit: 3664

**DETAILED ACTION**

***Claim Rejections - 35 USC § 103***

1. The following is a quotation of 35 U.S.C. 103(a) which forms the basis for all obviousness rejections set forth in this Office action:

(a) A patent may not be obtained though the invention is not identically disclosed or described as set forth in section 102 of this title, if the differences between the subject matter sought to be patented and the prior art are such that the subject matter as a whole would have been obvious at the time the invention was made to a person having ordinary skill in the art to which said subject matter pertains. Patentability shall not be negated by the manner in which the invention was made.

2. Claims 1-14 are rejected under 35 U.S.C. 103(a) as being unpatentable over Margolin (5904724) in view of Duggan et al (US 2005004723).

Regarding claim 1, Margolin (abstract; figs. 1-7; col. 3, lines 8-67; col. 4, lines 1-67; col. 5, lines 1-67) discloses a system for safely flying an unmanned aerial vehicle in civilian airspace comprising:

(a) a ground station 400 (fig. 1&4) equipped with a synthetic vision system (figs. 1&3; col. 4, lines 1 to col. 5, lines 67);

(b) an unmanned aerial vehicle 300 (figs. 1&3) capable of supporting said synthetic vision system (305, 306, 307, 311 on aircraft; col. 3, lines 8-67; col. 4, lines 1-67; col. 5, lines 1-67);

(c) a remote pilot 102 operating said ground station 400 (figs. 1&4; col. 3, lines 8-67; col. 4, lines 1-67; col. 5, lines 1-67);

(d) a communications link between said unmanned aerial vehicle 300 and said ground station 400;

Art Unit: 3664

e) a system onboard said unmanned aerial vehicle 300 for detecting the presence and position of nearby aircraft (305, 306, 307, 311 on aircraft) and communicating this information to said remote pilot 102 (col. 3, lines 8-67; col. 4, lines 1-67; col. 5, lines 1-67);

whereas said remote pilot uses said synthetic vision system (305, 306, 307, 311 on aircraft) to control said unmanned aerial vehicle 300 during at least selected phases of the flight of said unmanned aerial vehicle.

*Margolin did not disclose that the vehicle is flown using an autonomous control system. However, Duggan teach of a system for safely flying an unmanned aerial vehicle in civilian airspace comprising:*

*a ground station controlling an unmanned aerial vehicle (sec. 0352, 00353), wherein during phases of a flight of an unmanned aerial vehicle (UAV, sec 0318, 0322, 0353) when a synthetic vision (sec. 0356, 0365, 0388, 0390) is not used to control said unmanned aerial vehicle said unmanned aerial vehicle is flown using an autonomous control system (autopilot, sec 0346 to 0350, 0390-0329).*

*Therefore, it would have been obvious to one of ordinary skill in the art at the time the invention was made to modify Margolin as taught by Duggan for the purpose of incorporating an autopilot to ensure smooth transitions (Duggna abstract, sec 0014, 0085, 0086).*

*The different embodiments in both prior arts are combinable as it would be obvious to ne having ordinary skill in the art.*

Regarding claim 2, Margolin (abstract; figs. 1-7; col. 3, lines 8-67; col. 4, lines 1-67; col. 5, lines 1-67) in view of Duggan disclose the system of claim 1 whereby said selected phases of the flight of said unmanned aerial vehicle comprise:

Art Unit: 3664

(a) when said unmanned aerial vehicle is within a selected range of an airport or other designated location and is below a first specified altitude;

(b) when said unmanned aerial vehicle is outside said selected range of an airport or other designated location and is below a second specified altitude.

Regarding claim 3, Margolin (abstract; figs. 1-7; col. 3, lines 8-67; col. 4, lines 1-67; col. 5, lines 1-67) in view of Duggan disclose the system of claim 1 further comprising a system onboard said unmanned aerial vehicle for periodically transmitting the identification, location, altitude, and bearing of said unmanned aerial vehicle.

Regarding claim 4, Margolin (abstract; figs. 1-7; col. 3, lines 8-67; col. 4, lines 1-67; col. 5, lines 1-67) in view of Duggan disclose the system of claim 1 further comprising a system onboard said unmanned aerial vehicle for providing a communications channel for Air Traffic Control and the pilots of other aircraft to communicate directly with said remote pilot.

Regarding claim 5, Margolin (abstract; figs. 1-7; col. 3, lines 8-67; col. 4, lines 1-67; col. 5, lines 1-67) in view of Duggan disclose a system for safely flying an unmanned aerial vehicle in civilian airspace comprising:

- (a) a ground station equipped with a synthetic vision system;
- (b) an unmanned aerial vehicle capable of supporting said synthetic vision system;
- (c) a remote pilot operating said ground station;
- (d) a communications link between said unmanned aerial vehicle and said ground station;
- e) a system onboard said unmanned aerial vehicle for detecting the presence and position of nearby aircraft and communicating this information to said remote pilot;

Art Unit: 3664

whereas said remote pilot uses said synthetic vision system to control said unmanned aerial vehicle during at least selected phases of the flight of said unmanned aerial vehicle, and during those phases of the flight of said unmanned aerial vehicle when said synthetic vision system is not used to control said unmanned aerial vehicle said unmanned aerial vehicle is flown using an autonomous control system, and

whereas the selected phases of the flight of said unmanned aerial vehicle comprise:

(a) when said unmanned aerial vehicle is within a selected range of an airport or other designated location and is below a first specified altitude;

(b) when said unmanned aerial vehicle is outside said selected range of an airport or other designated location and is below a second specified altitude.

*Margolin did not disclose that the vehicle is flown using an autonomous control system. However, Duggan teach of a system for safely flying an unmanned aerial vehicle in civilian airspace comprising:*

*a ground station controlling an unmanned aerial vehicle (sec. 0352, 00353), wherein during phases of a flight of an unmanned aerial vehicle (UAV, sec 0318, 0322, 0353) when a synthetic vision (sec. 0356, 0365, 0388, 0390) is not used to control said unmanned aerial vehicle said unmanned aerial vehicle is flown using an autonomous control system (autopilot, sec 0346 to 0350, 0390-0329).*

*Therefore, it would have been obvious to one of ordinary skill in the art at the time the invention was made to modify Margolin as taught by Duggan for the purpose of incorporating an autopilot to ensure smooth transitions (Duggna abstract, sec 0014, 0085, 0086).*

Art Unit: 3664

*The different embodiments in both prior arts are combinable as it would be obvious to one having ordinary skill in the art.*

Regarding claim 6, Margolin (abstract; figs. 1-7; col. 3, lines 8-67; col. 4, lines 1-67; col. 5, lines 1-67) in view of Duggan disclose the system of claim 5 further comprising a system onboard said unmanned aerial vehicle for periodically transmitting the identification, location, altitude, and bearing of said unmanned aerial vehicle.

Regarding claim 7, Margolin (abstract; figs. 1-7; col. 3, lines 8-67; col. 4, lines 1-67; col. 5, lines 1-67) in view of Duggan disclose the system of claim 5 further comprising a system onboard said unmanned aerial vehicle for providing a communications channel for Air Traffic Control and the pilots of other aircraft to communicate directly with said remote pilot.

Regarding claim 8, Margolin (abstract; figs. 1-7; col. 3, lines 8-67; col. 4, lines 1-67; col. 5, lines 1-67) in view of Duggan disclose a method for safely flying an unmanned aerial vehicle as part of a unmanned aerial system equipped with a synthetic vision system in civilian airspace comprising the steps of:

(a) using a remote pilot to fly said unmanned aerial vehicle using synthetic vision during at least selected phases of the flight of said unmanned aerial vehicle, and during those phases of the flight of said unmanned aerial vehicle when said synthetic vision system is not used to control said unmanned aerial vehicle an autonomous control system is used to fly said unmanned aerial vehicle;

(b) providing a system onboard said unmanned aerial vehicle for detecting the presence and position of nearby aircraft and communicating this information to said remote pilot.



Art Unit: 3664

*Margolin did not disclose that the vehicle is flown using an autonomous control system. However, Duggan teach of a system for safely flying an unmanned aerial vehicle in civilian airspace comprising:*

*a ground station controlling an unmanned aerial vehicle (sec. 0352, 00353), wherein during phases of a flight of an unmanned aerial vehicle (UAV, sec 0318, 0322, 0353) when a synthetic vision (sec. 0356, 0365, 0388, 0390) is not used to control said unmanned aerial vehicle said unmanned aerial vehicle is flown using an autonomous control system (autopilot, sec 0346 to 0350, 0390-0329).*

*Therefore, it would have been obvious to one of ordinary skill in the art at the time the invention was made to modify Margolin as taught by Duggan for the purpose of incorporating an autopilot to ensure smooth transitions (Duggna abstract, sec 0014, 0085, 0086).*

*The different embodiments in both prior arts are combinable as it would be obvious to ne having ordinary skill in the art.*

Regarding claim 9, Margolin (abstract; figs. 1-7; col. 3, lines 8-67; col. 4, lines 1-67; col. 5, lines 1-67) in view of Duggan disclose the method of claim 8 whereby said selected phases of the flight of said unmanned aerial vehicle comprise:

(a) when said unmanned aerial vehicle is within a selected range of an airport or other designated location and is below a first specified altitude;

(b) when said unmanned aerial vehicle is outside said selected range of an airport or other designated location and is below a second specified altitude.

Regarding claim 10, Margolin (abstract; figs. 1-7; col. 3, lines 8-67; col. 4, lines 1-67; col. 5, lines 1-67) in view of Duggan disclose the method of claim 8 further comprising the step

Art Unit: 3664

of providing a system onboard said unmanned aerial vehicle for periodically transmitting the identification, location, altitude, and bearing of said unmanned aerial vehicle.

Regarding claim 11, Margolin (abstract; figs. 1-7; col. 3, lines 8-67; col. 4, lines 1-67; col. 5, lines 1-67) in view of Duggan disclose the method of claim 8 further comprising the step of providing a system onboard said unmanned aerial vehicle for providing a communications channel for Air Traffic Control and the pilots of other aircraft to communicate directly with said remote pilot.

Regarding claim 12, Margolin (abstract; figs. 1-7; col. 3, lines 8-67; col. 4, lines 1-67; col. 5, lines 1-67) in view of Duggan disclose a method for safely flying an unmanned aerial vehicle as part of a unmanned aerial system equipped with a synthetic vision system in civilian airspace comprising the steps of:

(a) using a remote pilot to fly said unmanned aerial vehicle using synthetic vision during at least selected phases of the flight of said unmanned aerial vehicle, and during those phases of the flight of said unmanned aerial vehicle when said synthetic vision system is not used to control said unmanned aerial vehicle an autonomous control system is used to fly said unmanned aerial vehicle;

(b) providing a system onboard said unmanned aerial vehicle for detecting the presence and position of nearby aircraft and communicating this information to said remote pilot;

whereas said selected phases of the flight of said unmanned aerial vehicle comprise:

(a) when said unmanned aerial vehicle is within a selected range of an airport or other designated location and is below a first specified altitude;

Art Unit: 3664

(b) when said unmanned aerial vehicle is outside said selected range of an airport or other designated location and is below a second specified altitude.

*Margolin did not disclose that the vehicle is flown using an autonomous control system. However, Duggan teach of a system for safely flying an unmanned aerial vehicle in civilian airspace comprising:*

*a ground station controlling an unmanned aerial vehicle (sec. 0352, 00353), wherein during phases of a flight of an unmanned aerial vehicle (UAV, sec 0318, 0322, 0353) when a synthetic vision (sec. 0356, 0365, 0388, 0390) is not used to control said unmanned aerial vehicle said unmanned aerial vehicle is flown using an autonomous control system (autopilot, sec 0346 to 0350, 0390-0329).*

*Therefore, it would have been obvious to one of ordinary skill in the art at the time the invention was made to modify Margolin as taught by Duggan for the purpose of incorporating an autopilot to ensure smooth transitions (Duggna abstract, sec 0014, 0085, 0086).*

*The different embodiments in both prior arts are combinable as it would be obvious to ne having ordinary skill in the art.*

Regarding claim 13, Margolin (abstract; figs. 1-7; col. 3, lines 8-67; col. 4, lines 1-67; col. 5, lines 1-67) in view of Duggan disclose the method of claim 12 further comprising the step of providing a system onboard said unmanned aerial vehicle for periodically transmitting the identification, location, altitude, and bearing of said unmanned aerial vehicle.

Regarding claim 14, Margolin (abstract; figs. 1-7; col. 3, lines 8-67; col. 4, lines 1-67; col. 5, lines 1-67) in view of Duggan disclose the method of claim 12 further comprising the step of providing a system onboard said unmanned aerial vehicle for providing a communications

Art Unit: 3664

channel for Air Traffic Control and the pilots of other aircraft to communicate directly with said remote pilot.

### *Communication*

3. Any inquiry concerning this communication or earlier communications from the examiner should be directed to RONNIE MANCHO whose telephone number is (571)272-6984. The examiner can normally be reached on Mon-Thurs: 9-5.

If attempts to reach the examiner by telephone are unsuccessful, the examiner's supervisor, Tran Khoi can be reached on 571-272-6919. The fax phone number for the organization where this application or proceeding is assigned is 571-273-8300.

Information regarding the status of an application may be obtained from the Patent Application Information Retrieval (PAIR) system. Status information for published applications may be obtained from either Private PAIR or Public PAIR. Status information for unpublished applications is available through Private PAIR only. For more information about the PAIR system, see <http://pair-direct.uspto.gov>. Should you have questions on access to the Private PAIR system, contact the Electronic Business Center (EBC) at 866-217-9197 (toll-free). If you would like assistance from a USPTO Customer Service Representative or access to the automated information system, call 800-786-9199 (IN USA OR CANADA) or 571-272-1000.

/Ronnie Mancho/  
Primary Examiner, Art Unit 3664

/Ronnie Mancho/  
Primary Examiner, Art Unit 3664

Application/Control Number: 11/736,356  
Art Unit: 3664

Page 11

# Exhibit 4

# Exhibit 4



US 20050004723A1

(19) **United States**

(12) **Patent Application Publication** (10) **Pub. No.: US 2005/0004723 A1**

**Duggan et al.**

(43) **Pub. Date: Jan. 6, 2005**

(54) **VEHICLE CONTROL SYSTEM INCLUDING RELATED METHODS AND COMPONENTS**

**Related U.S. Application Data**

(75) Inventors: **David S. Duggan**, Aubrey, TX (US);  
**David A. Felio**, Highland Village, TX (US);  
**Billy B. Pate**, Houston, TX (US);  
**Vince R. Longhi**, Dallas, TX (US);  
**Jerry L. Petersen**, Southlake, TX (US);  
**Mark J. Bergee**, Dallas, TX (US)

(60) Provisional application No. 60/480,192, filed on Jun. 20, 2003.

**Publication Classification**

(51) **Int. Cl.<sup>7</sup> ..... G06F 17/00**

(52) **U.S. Cl. .... 701/24; 701/11; 701/13**

(57) **ABSTRACT**

Embodiments are disclosed for a vehicle control system and related sub-components that together provide an operator with a plurality of specific modes of operation, wherein various modes of operation incorporate different levels of autonomous control. Through a control user interface, an operator can move between certain modes of control even after vehicle deployment. Specialized autopilot system components and methods are employed to ensure smooth transitions between control modes. Empowered by the multi-modal control system, an operator can even manage multiple vehicles simultaneously.

Correspondence Address:

**Christopher L. Holt**  
**Westman, Champlin & Kelly**  
**Suite 1600**  
**900 Second Avenue South**  
**Minneapolis, MN 55402-3319 (US)**

(73) Assignee: **Geneva Aerospace**, Carrollton, TX

(21) Appl. No.: **10/871,612**

(22) Filed: **Jun. 18, 2004**

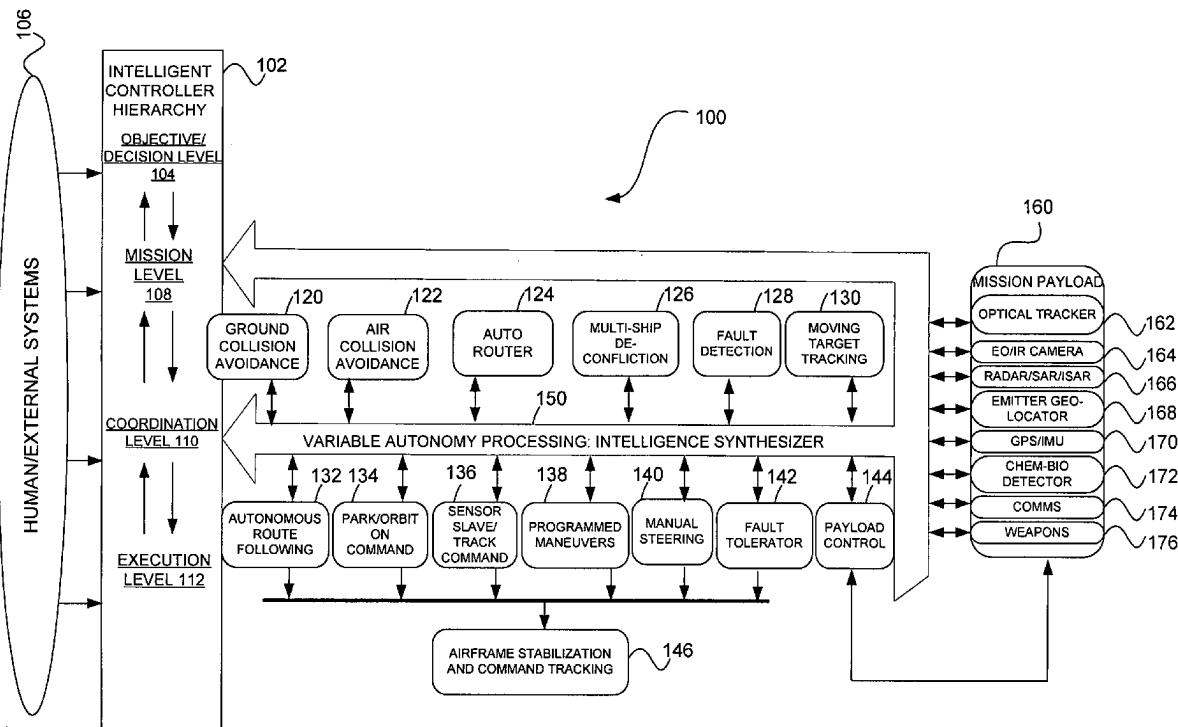

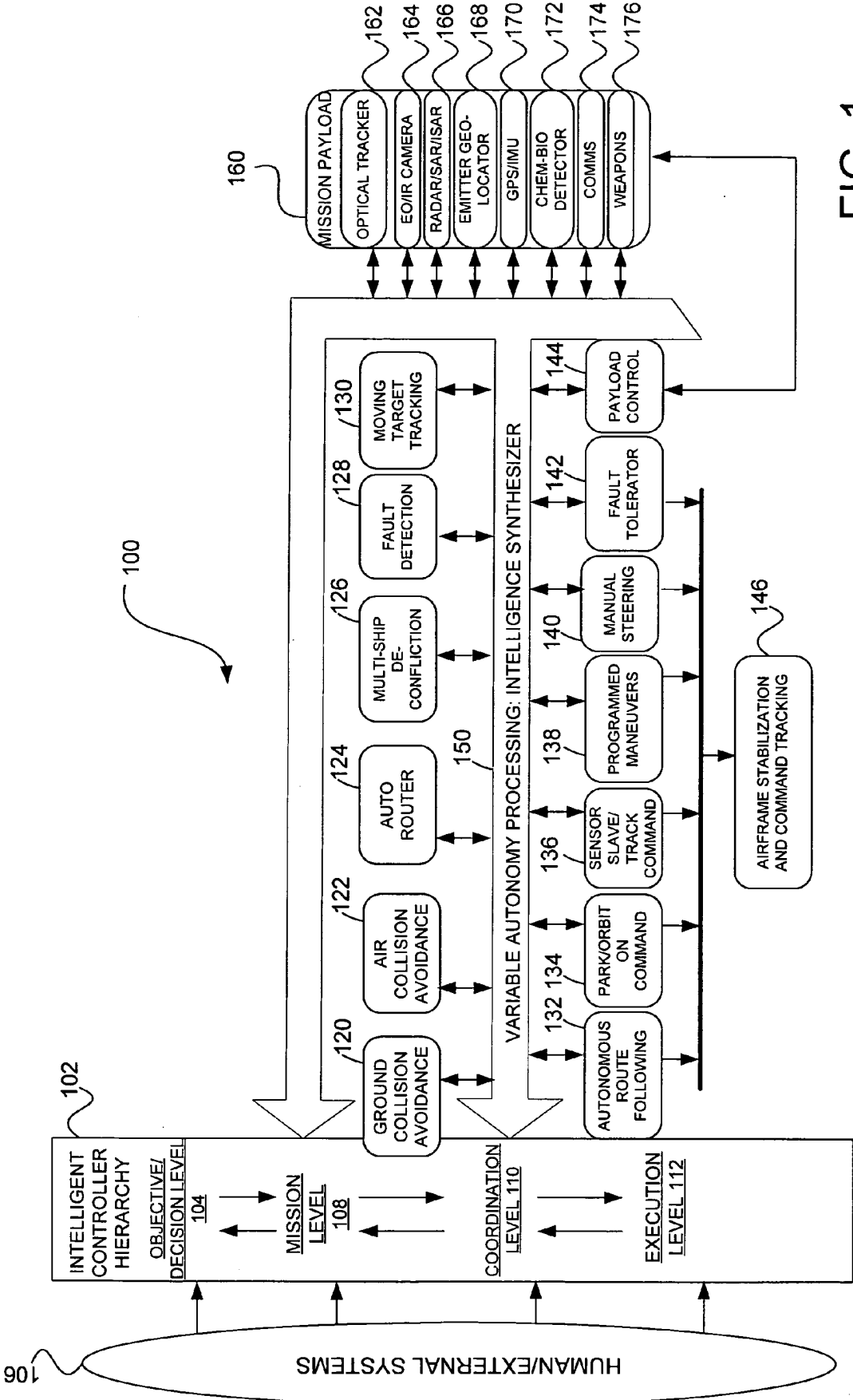

FIG. 1



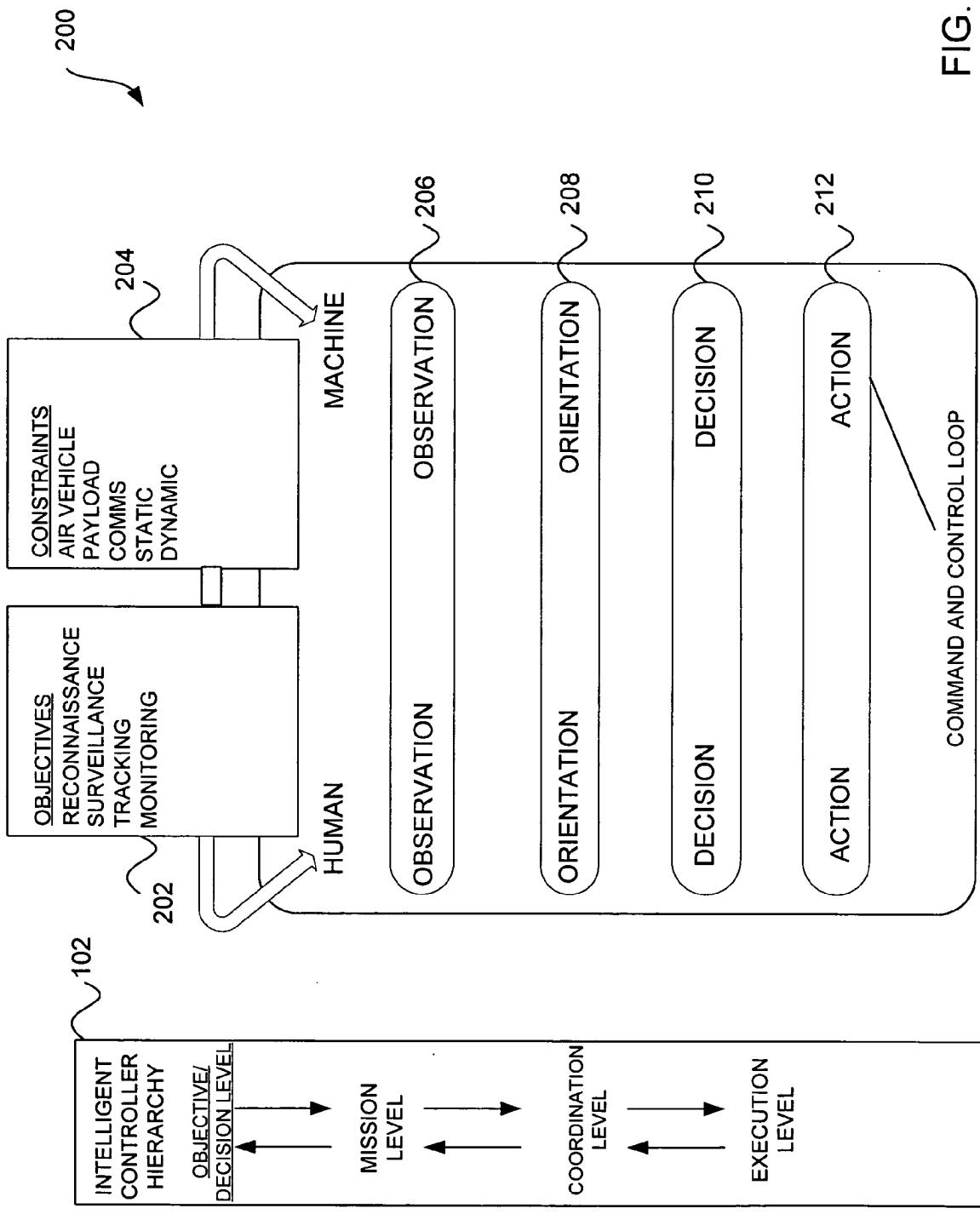

FIG. 2

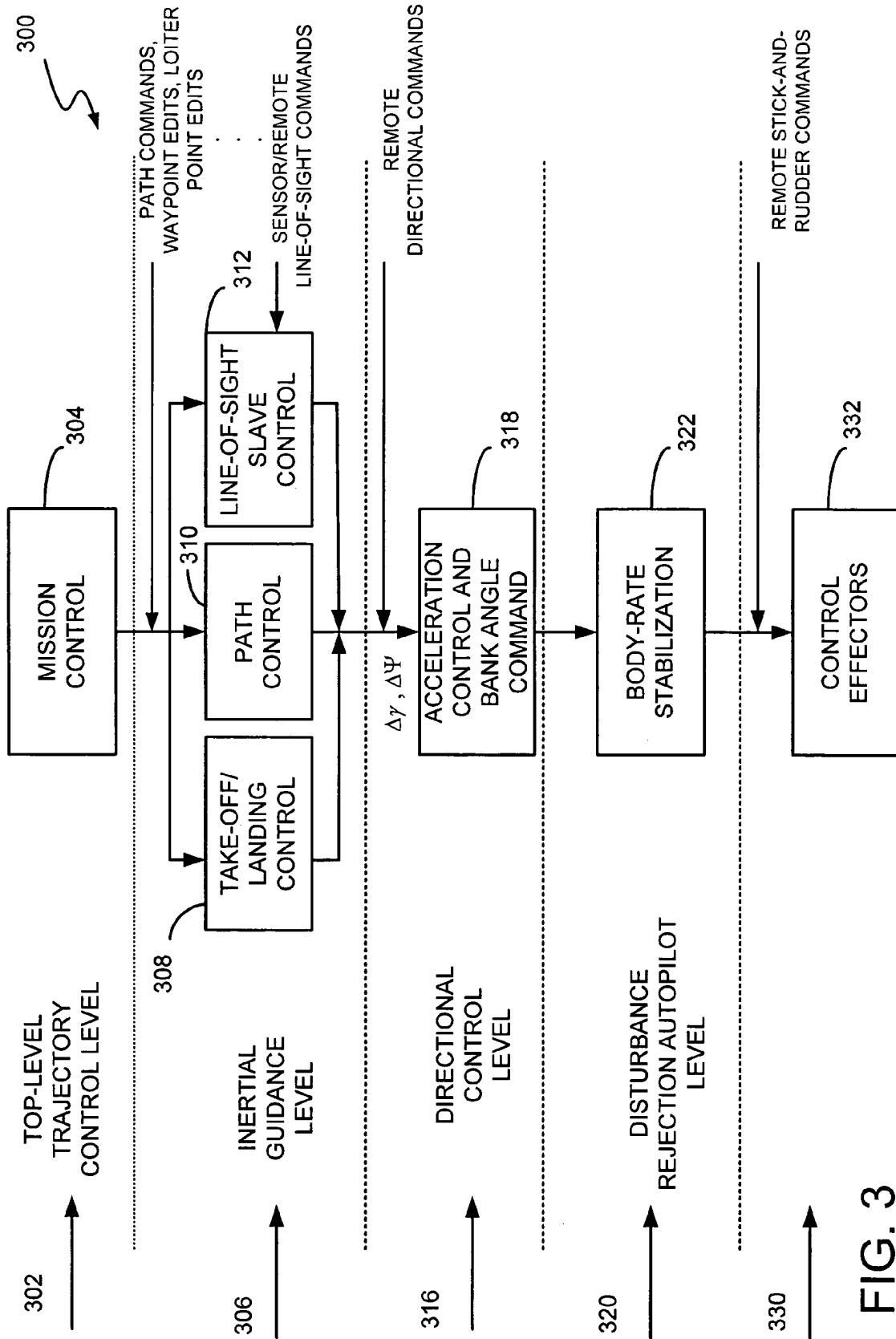

FIG. 3

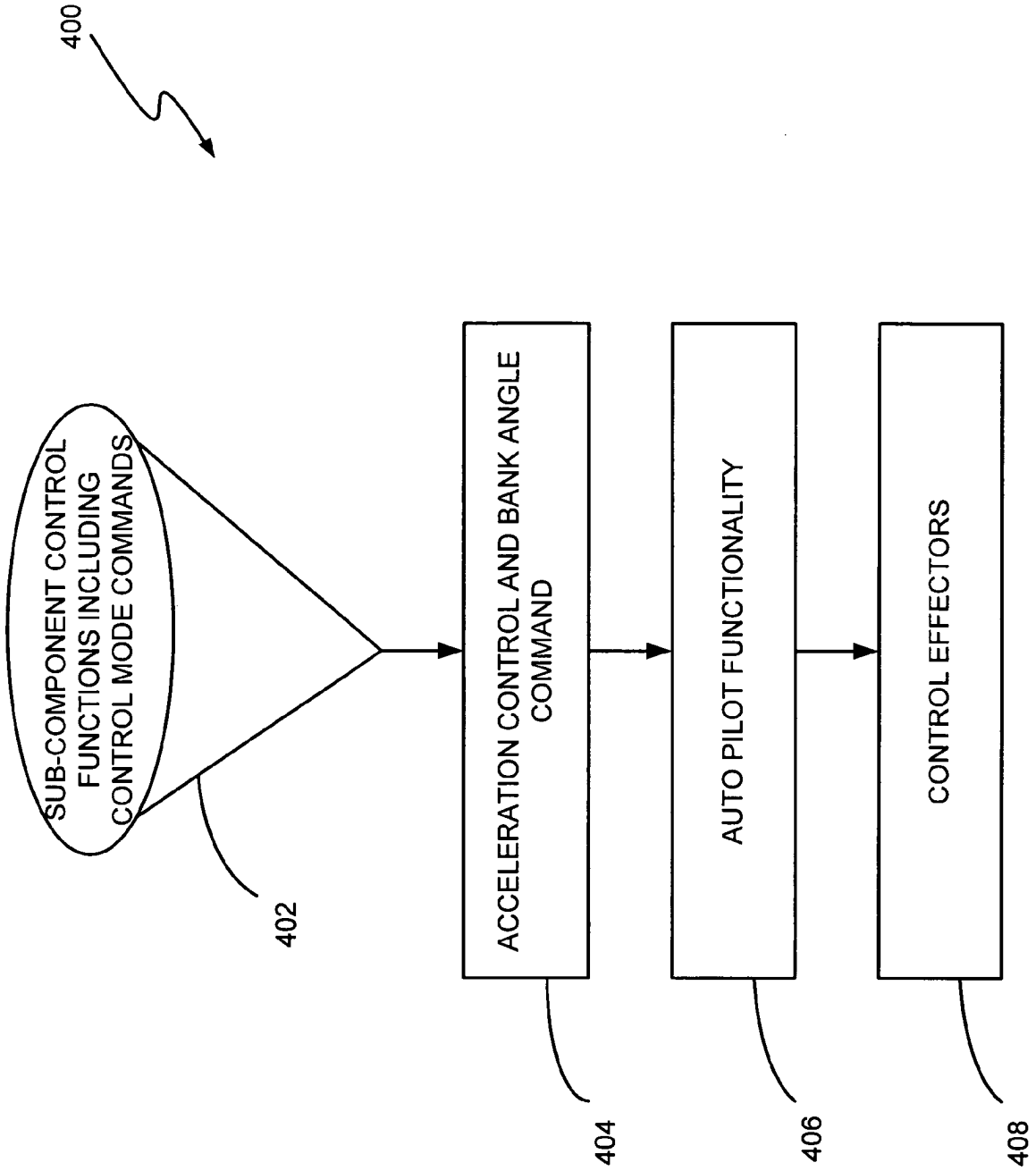

FIG. 4

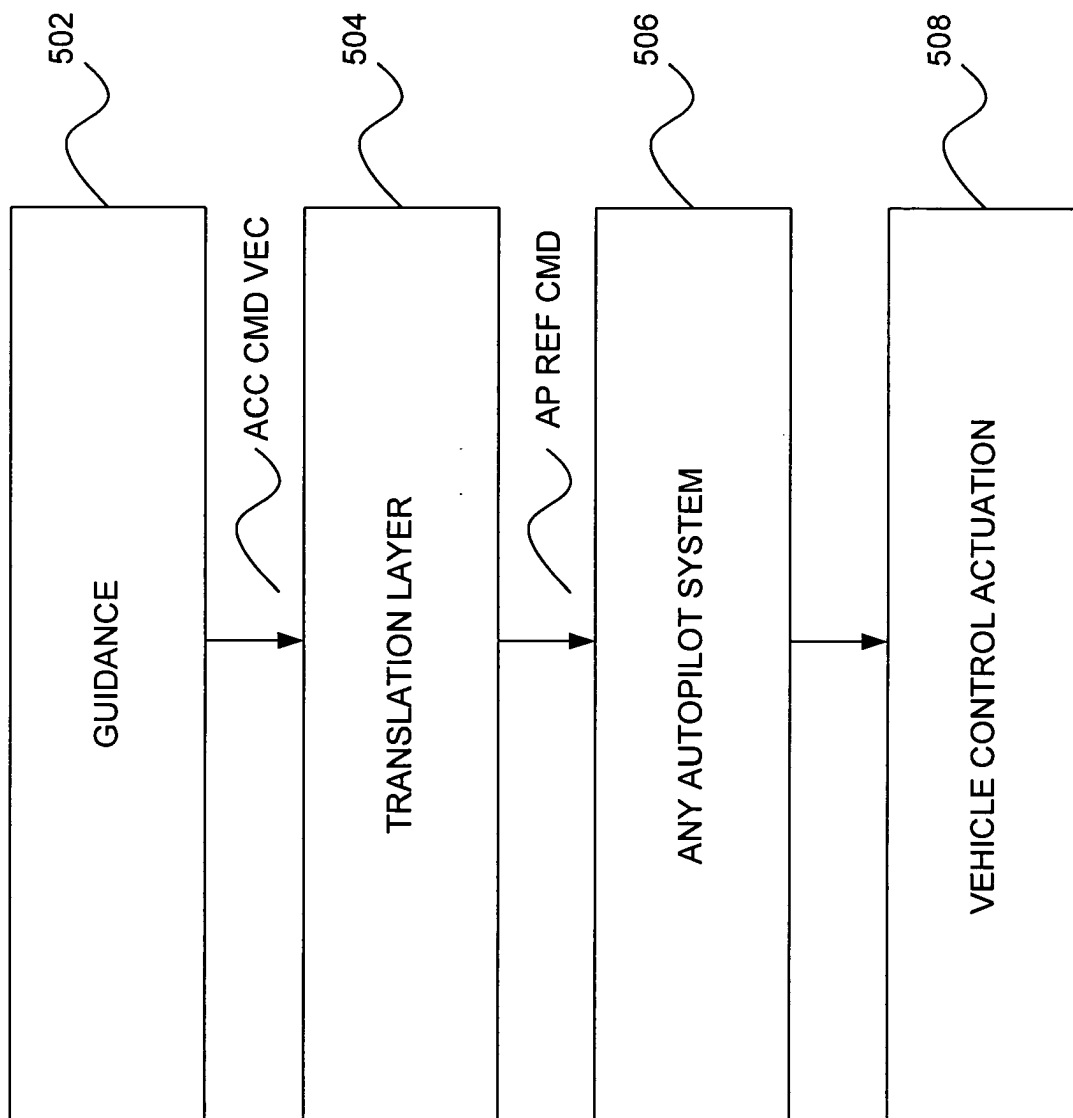

FIG. 5

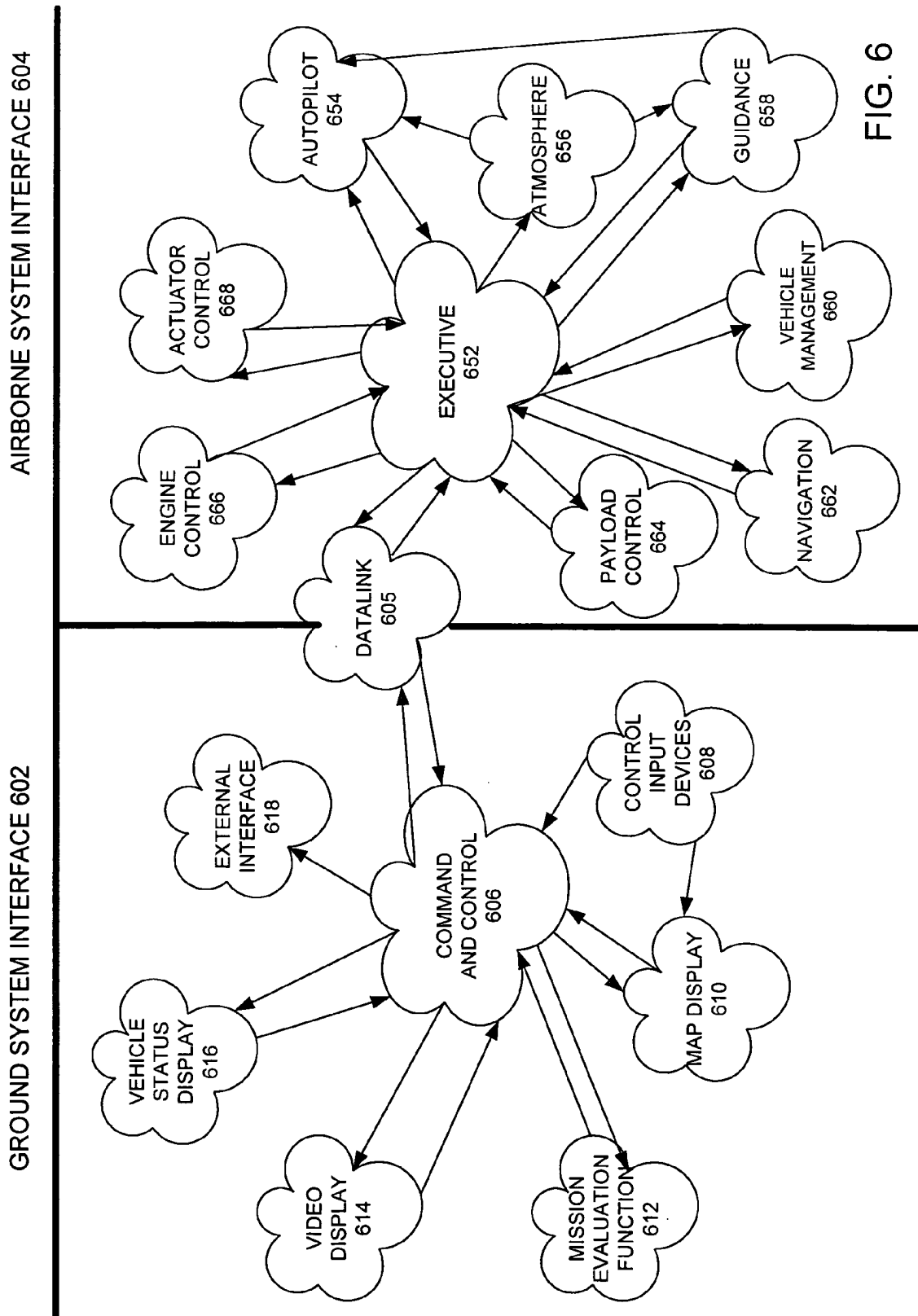

FIG. 6

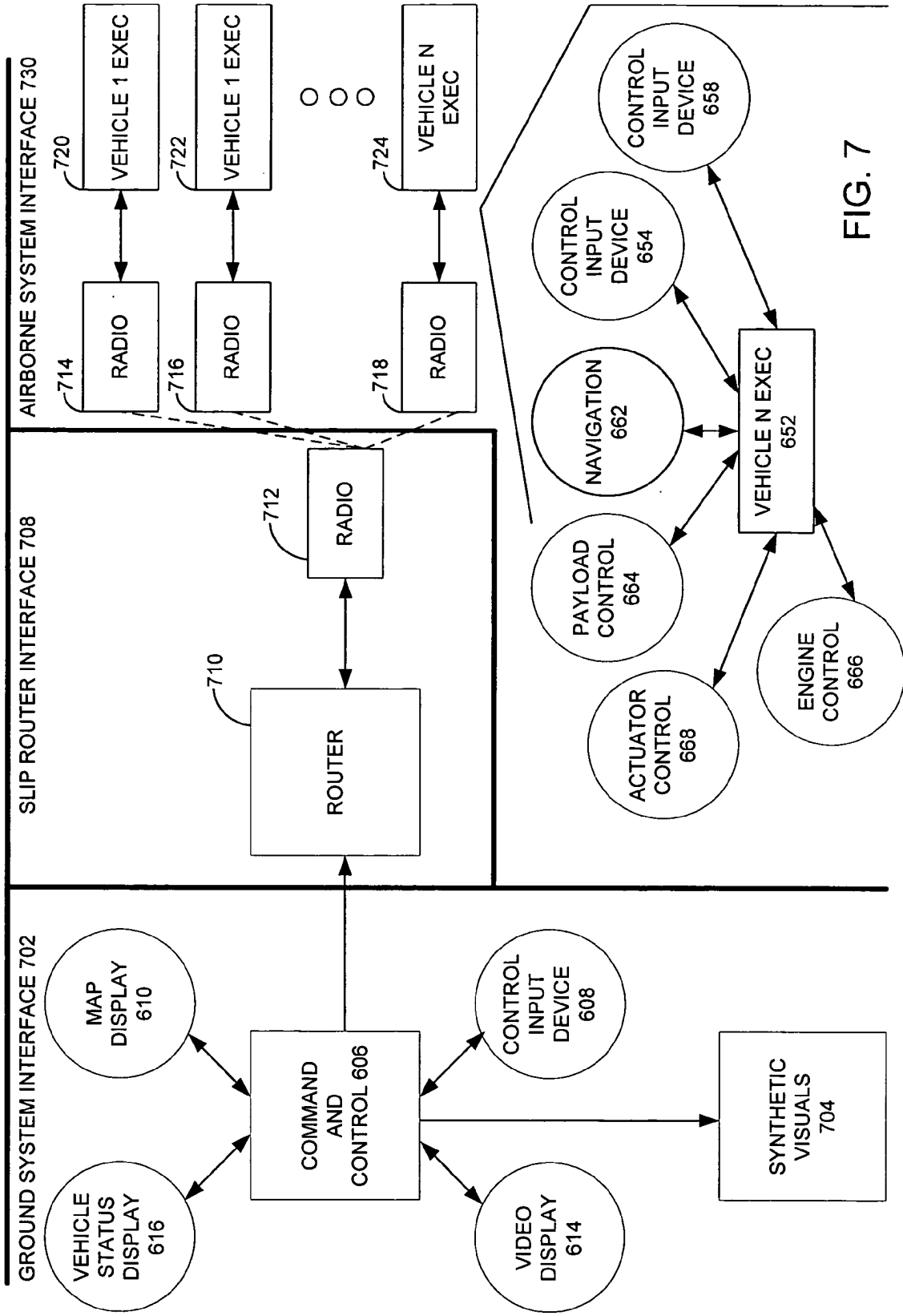

FIG. 7

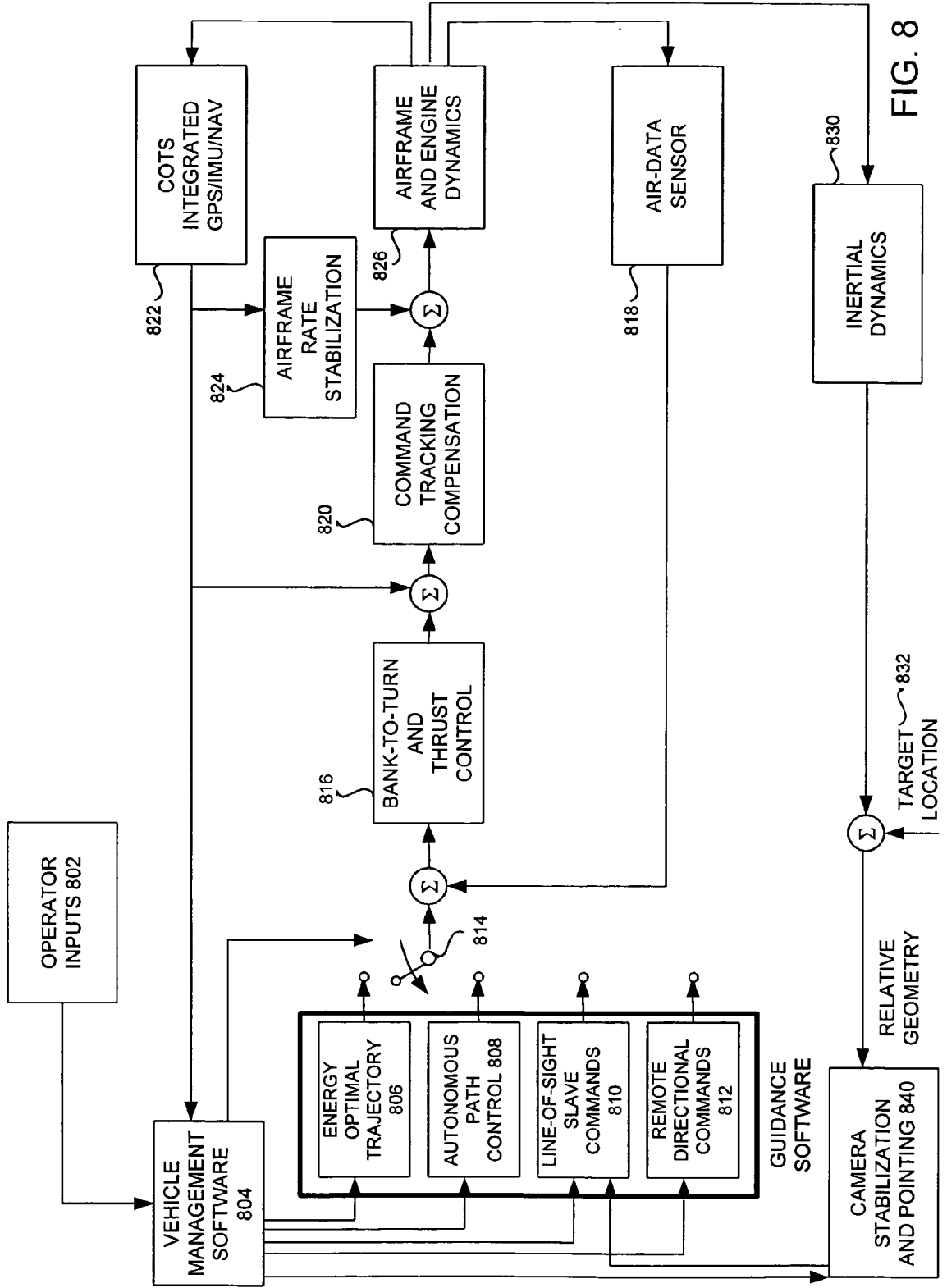

FIG. 8

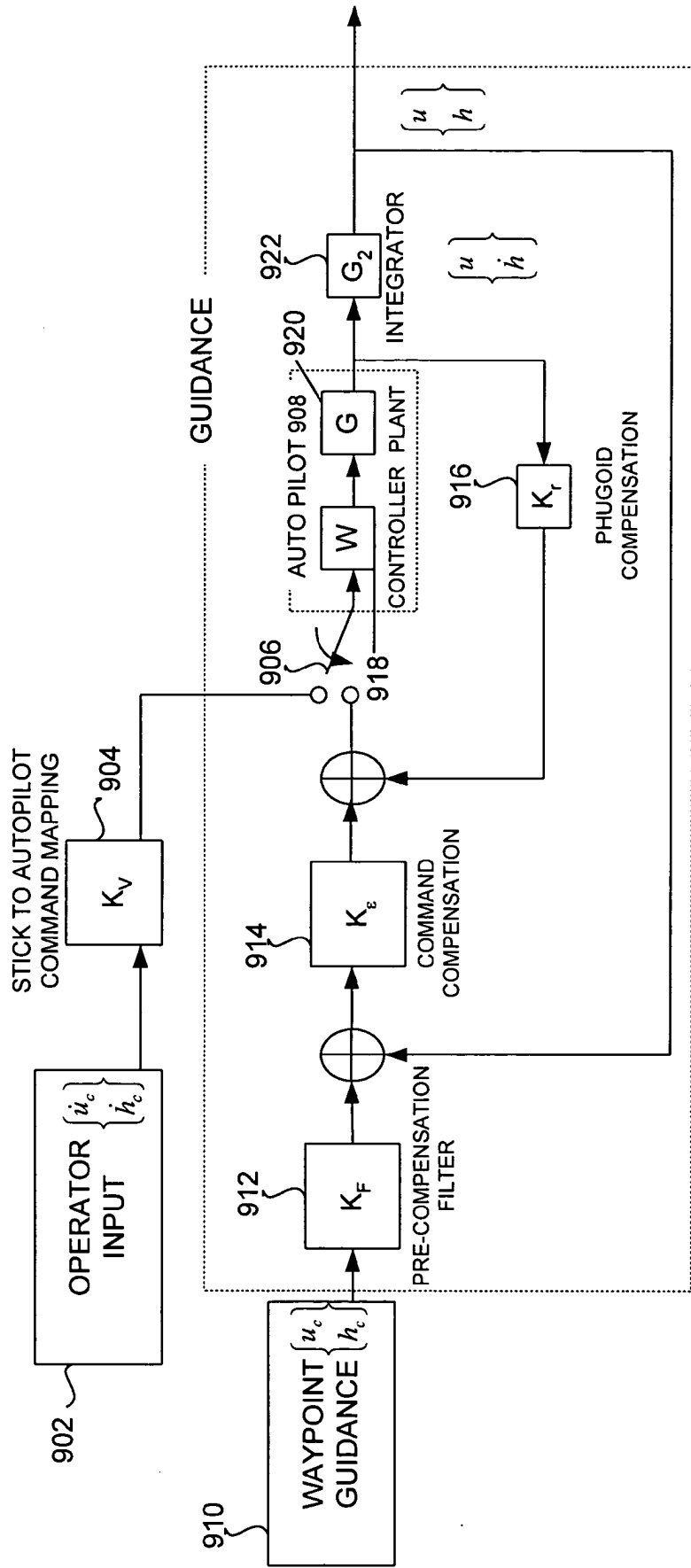

FIG. 9



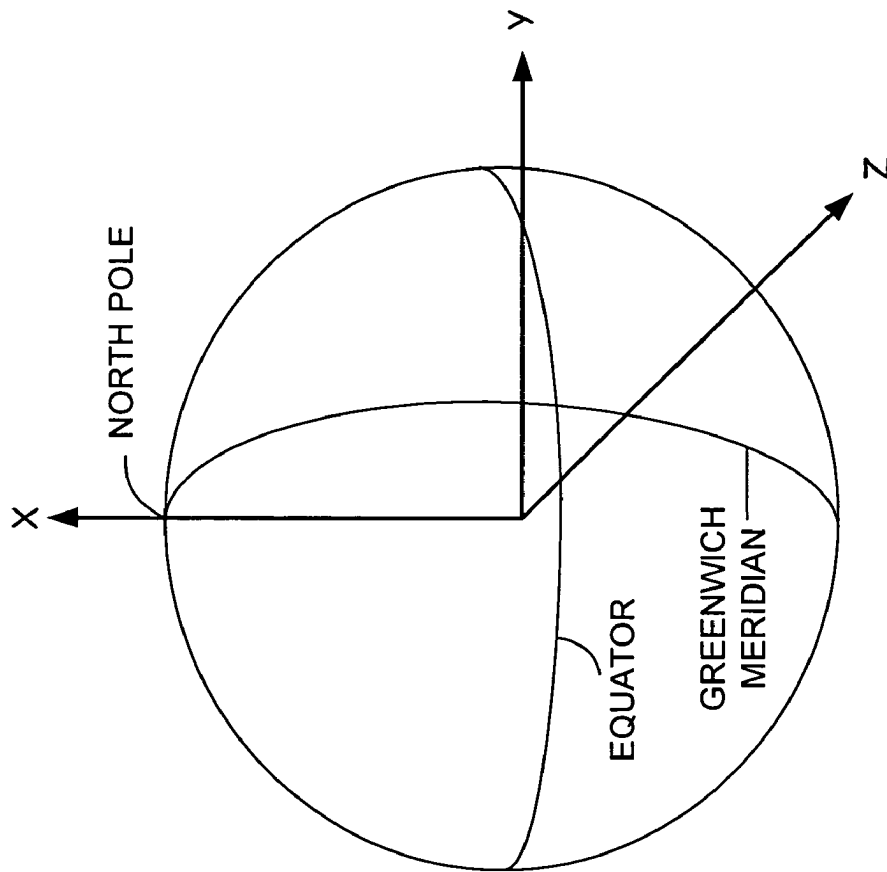

FIG. 10-1

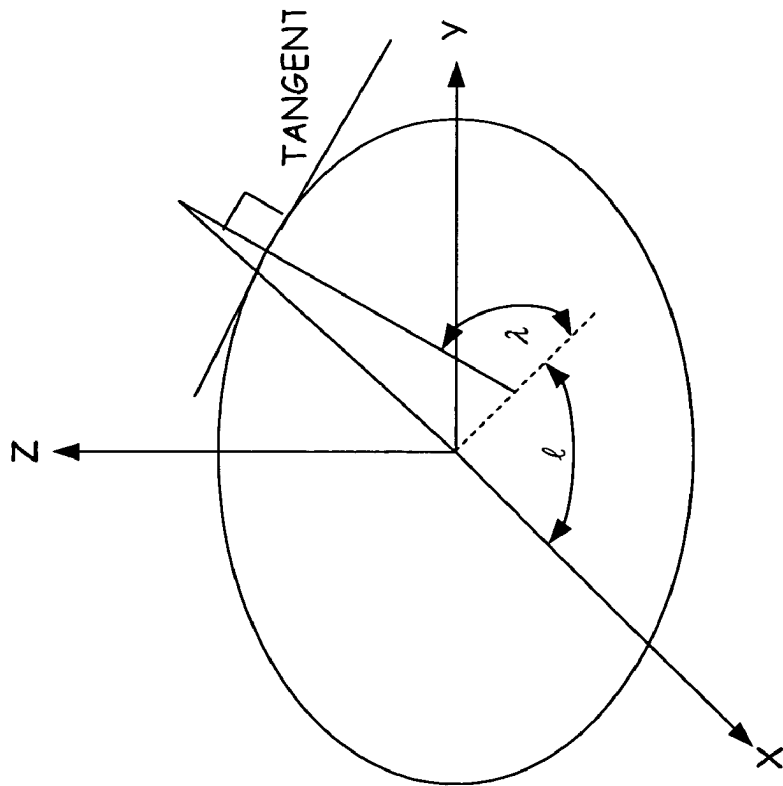

FIG. 10-3

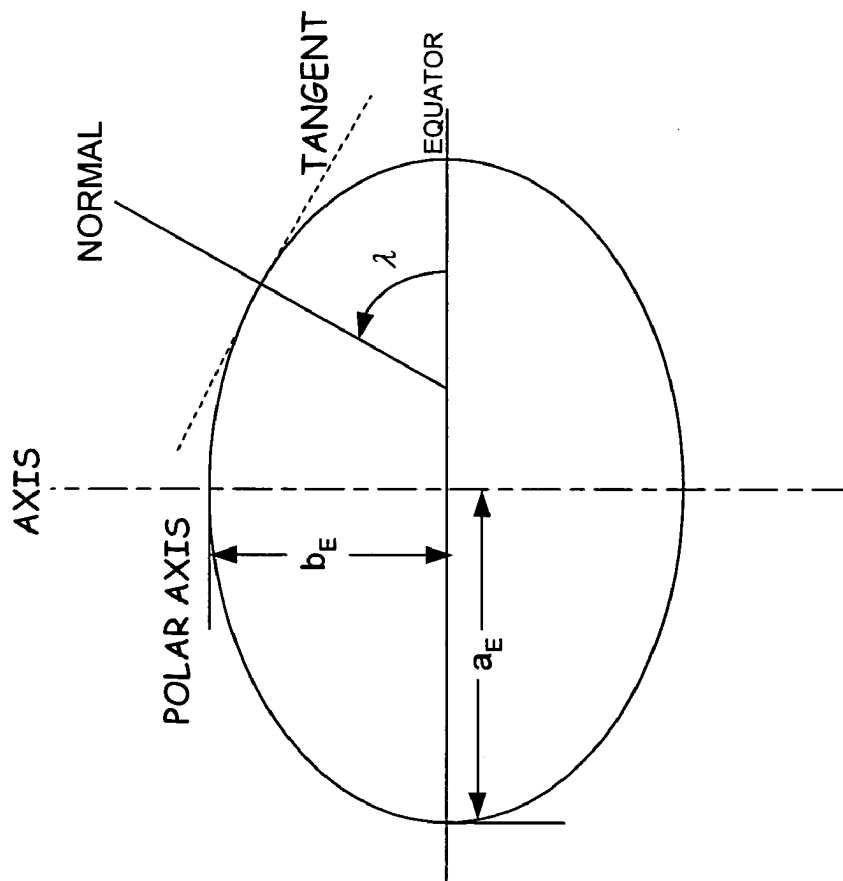

FIG. 10-2

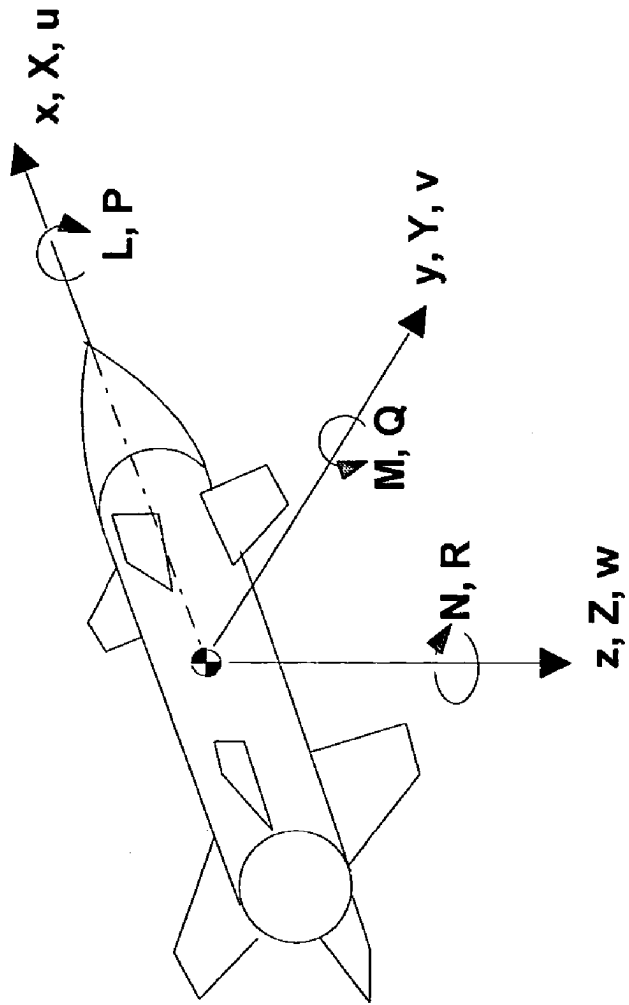

FIG. 10-4

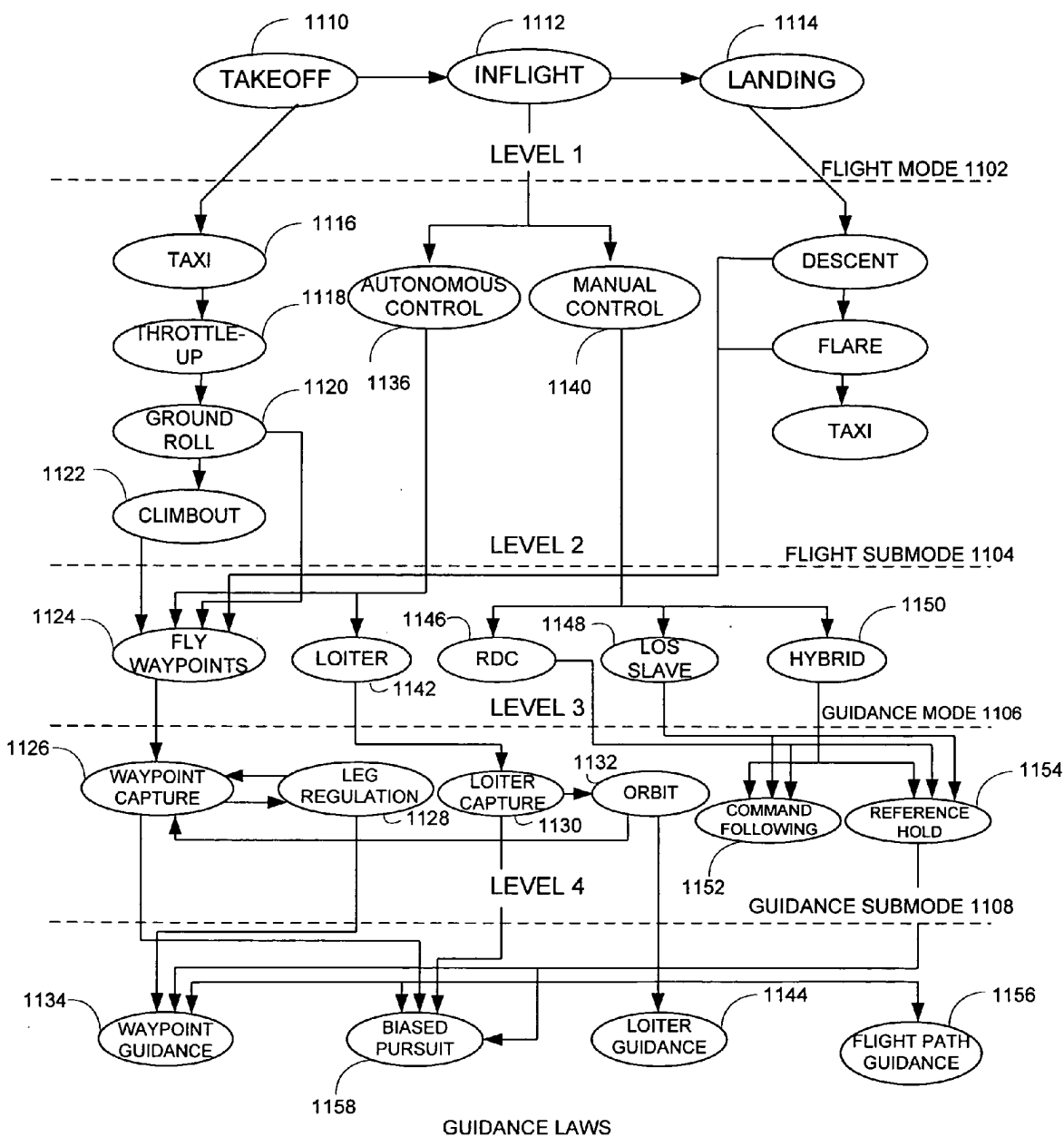

FIG. 11

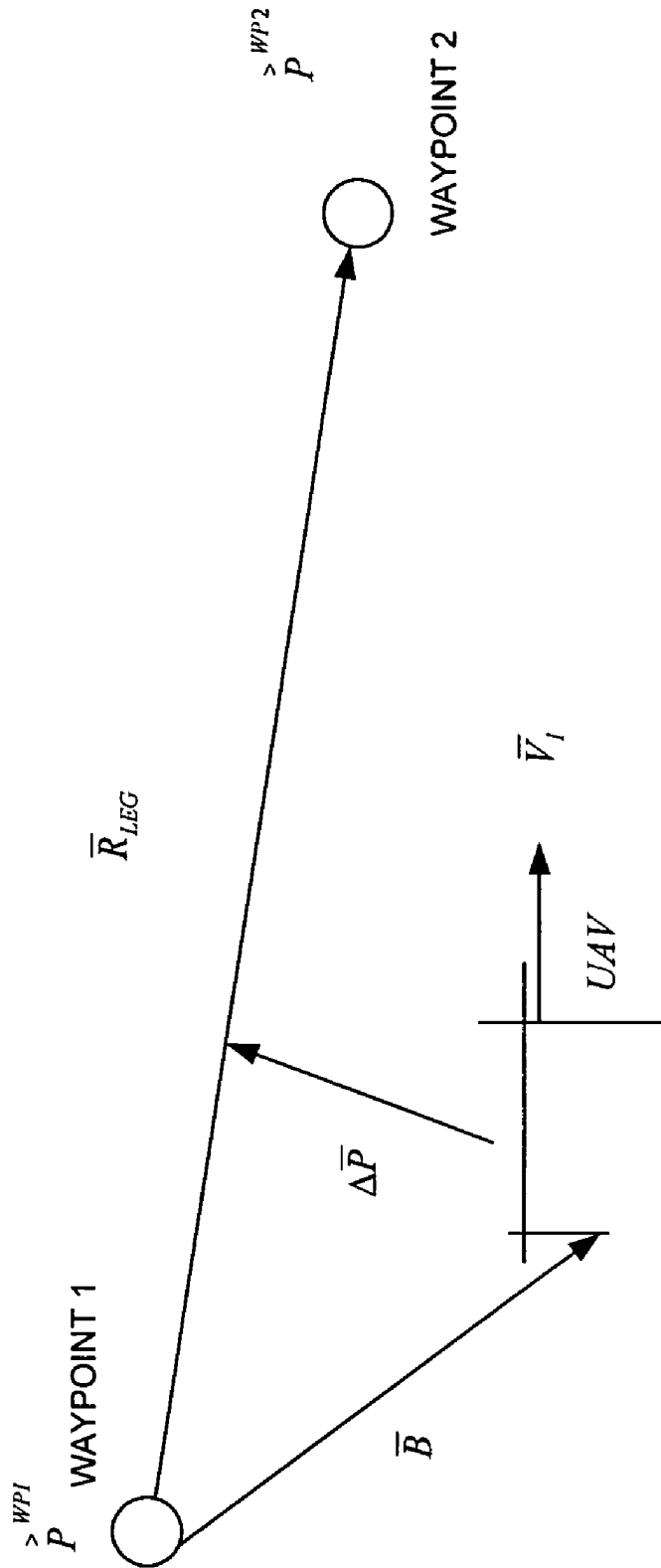

FIG. 12

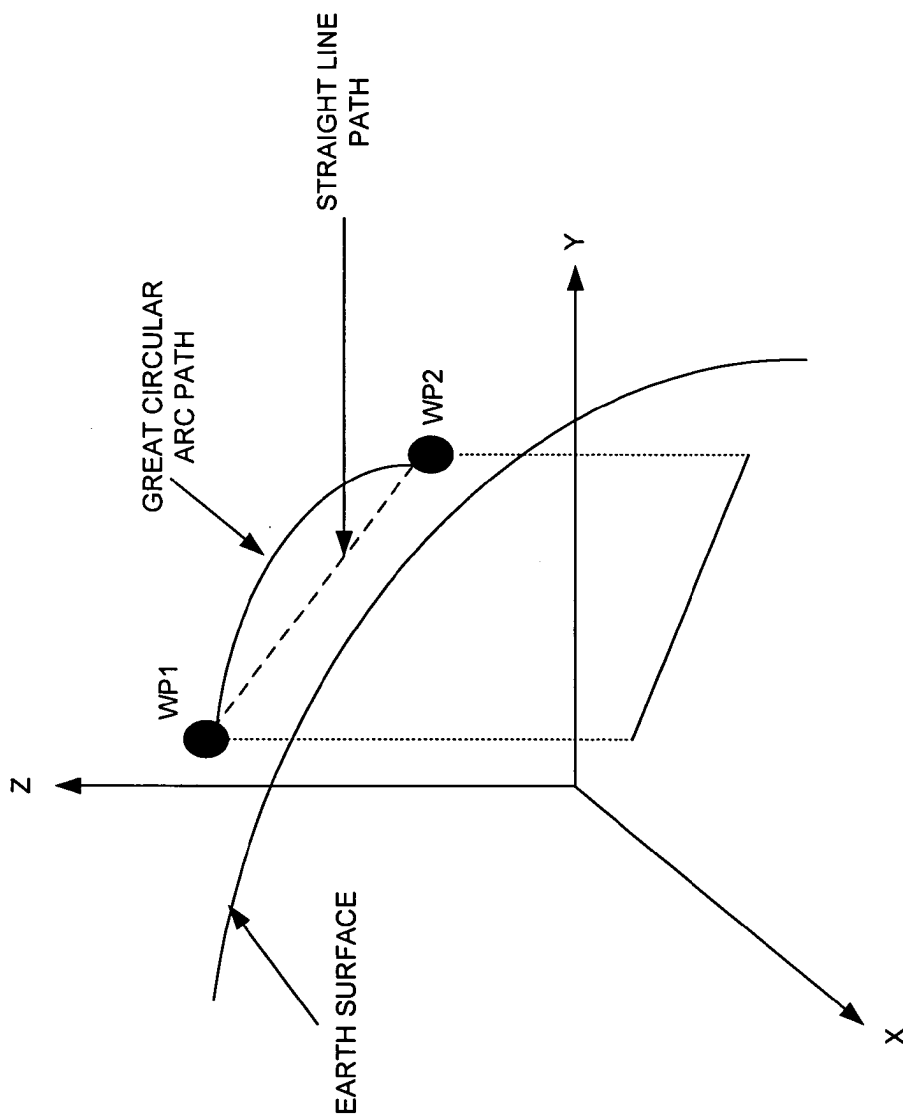

FIG. 13

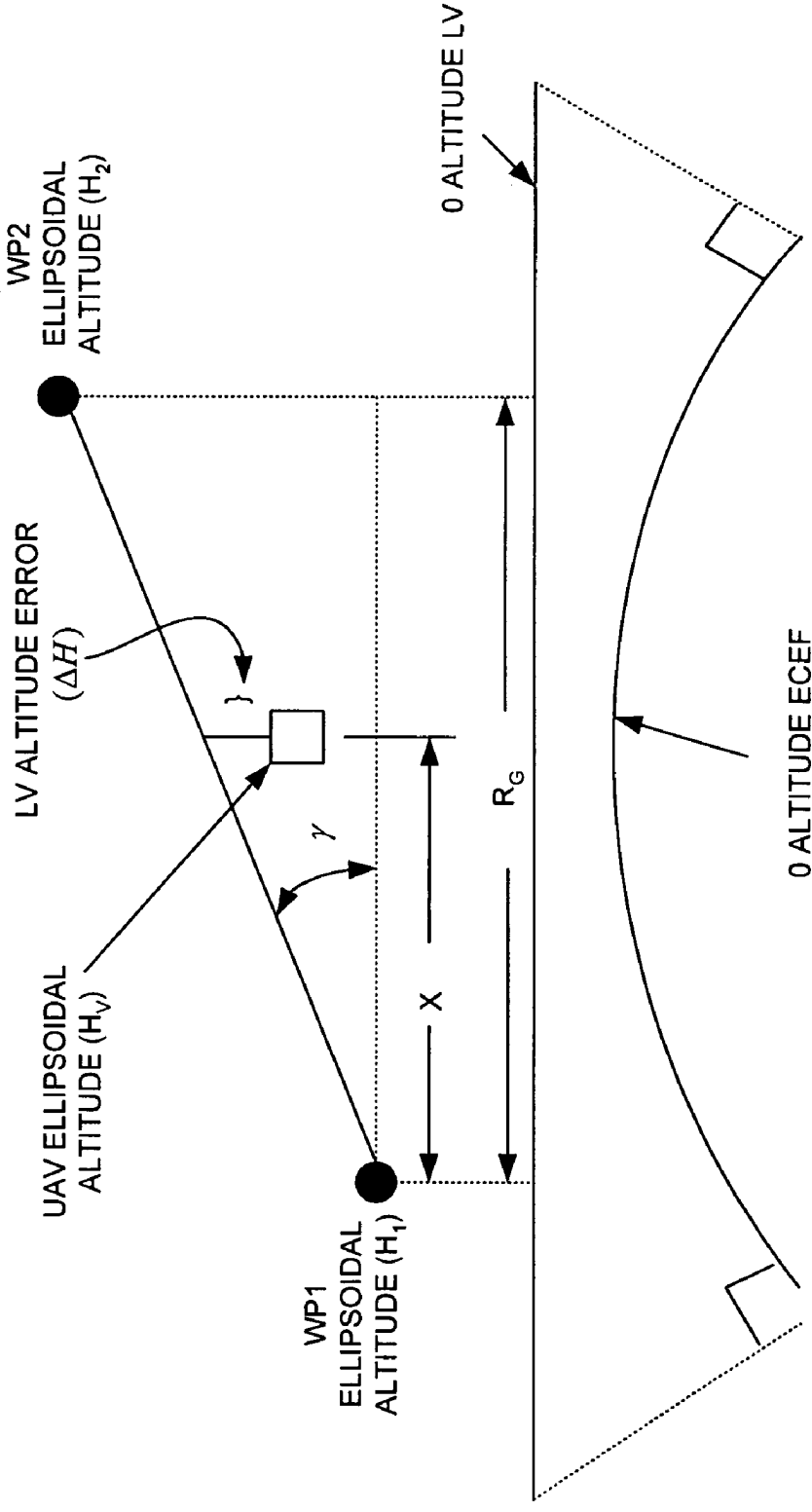

FIG. 14

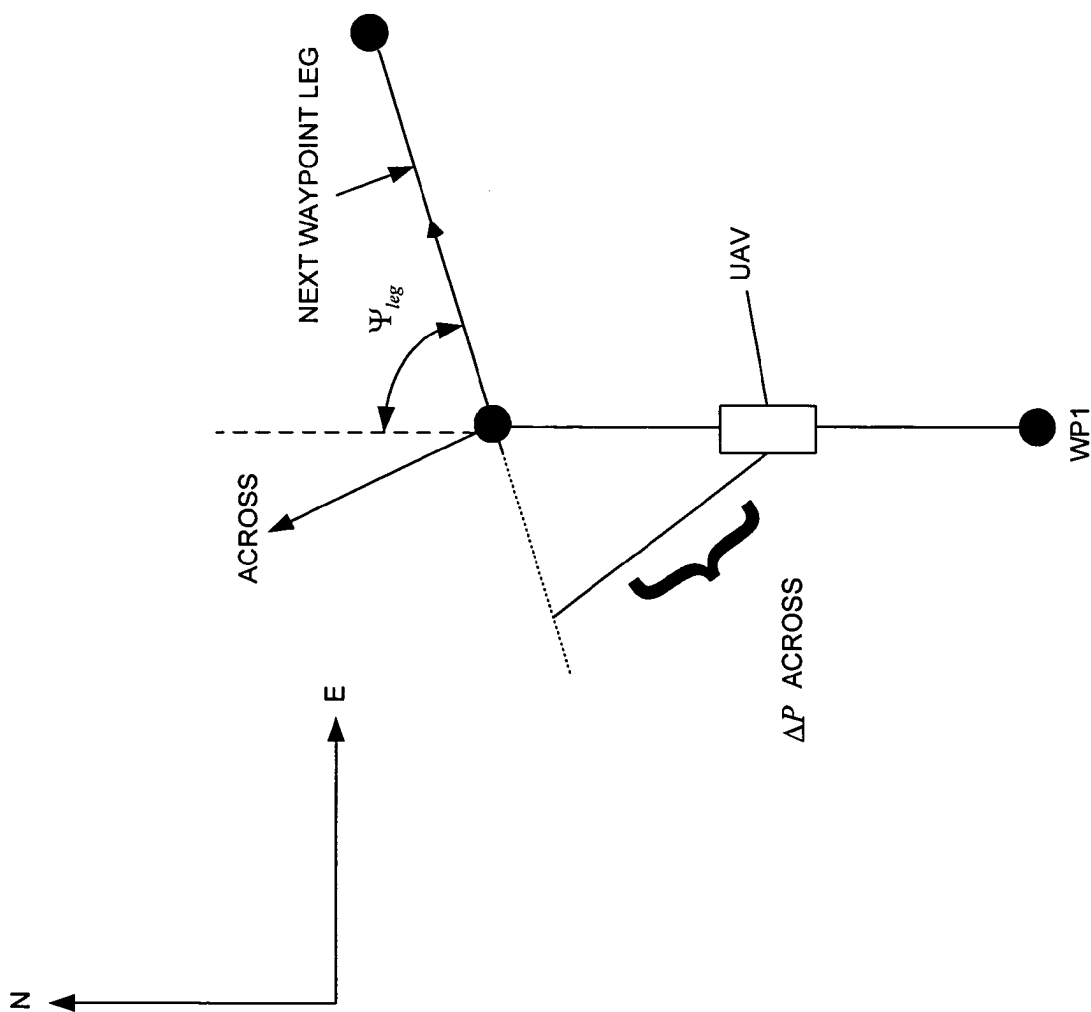

FIG. 15



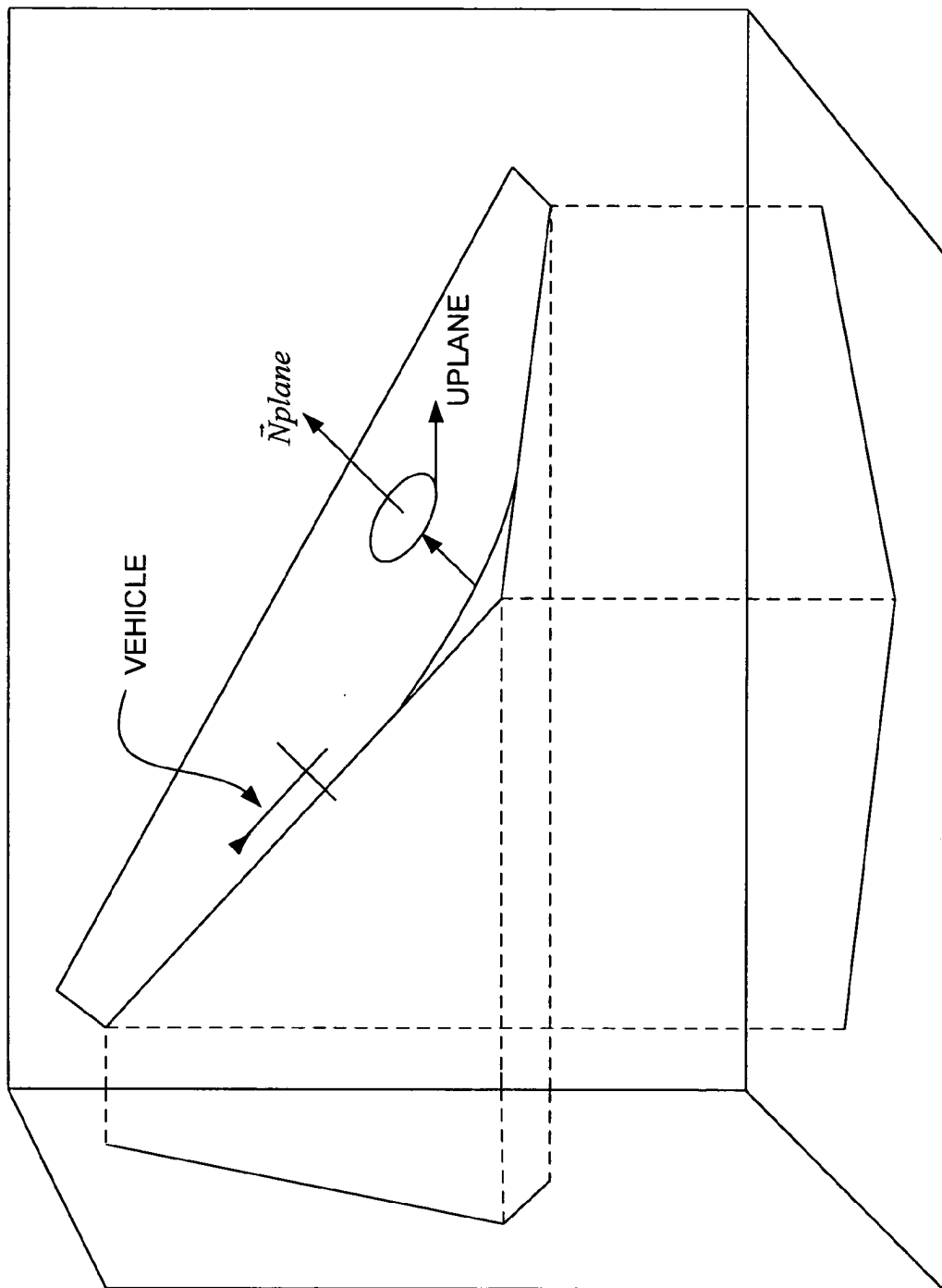

FIG. 16

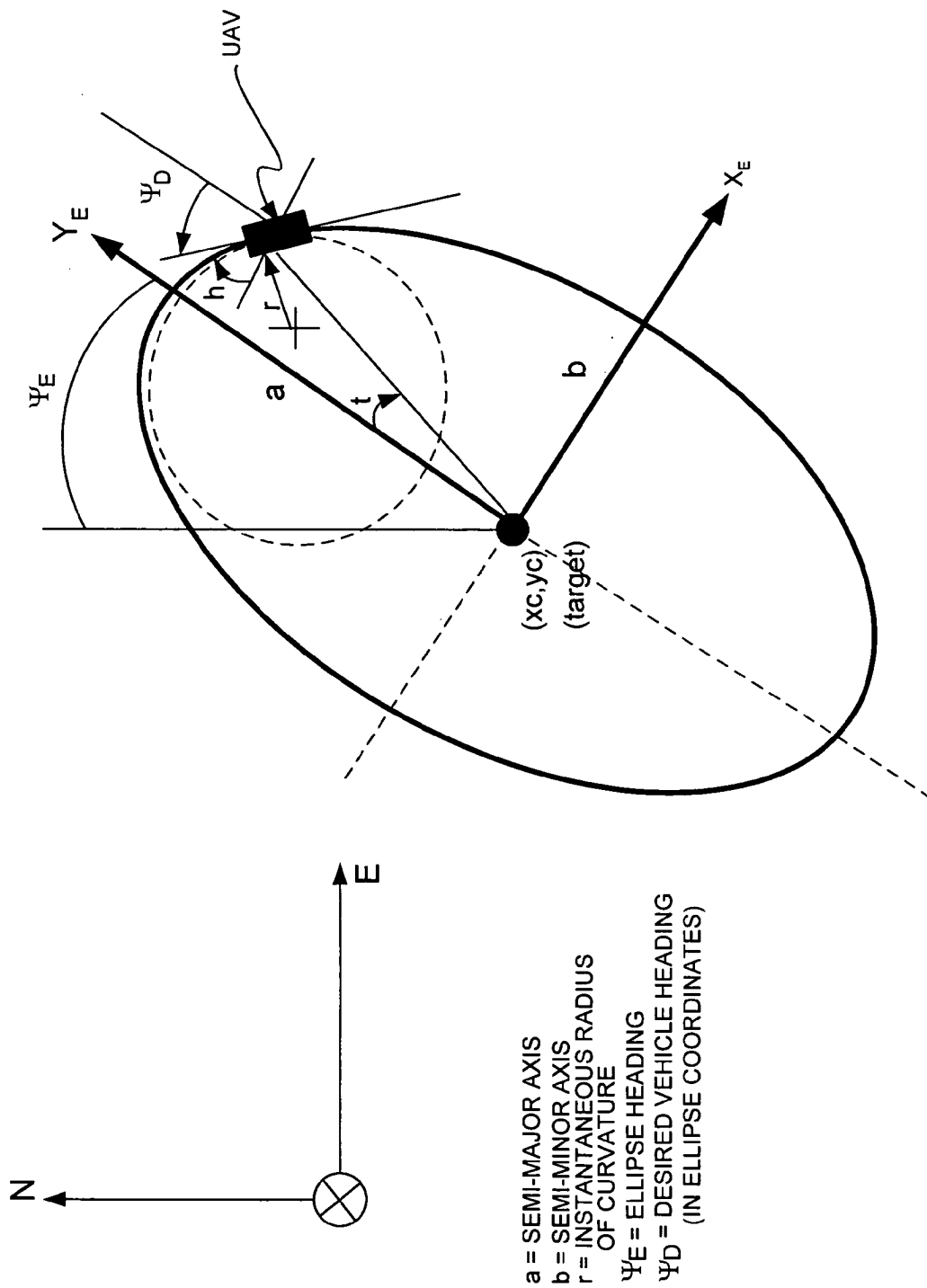

FIG. 17

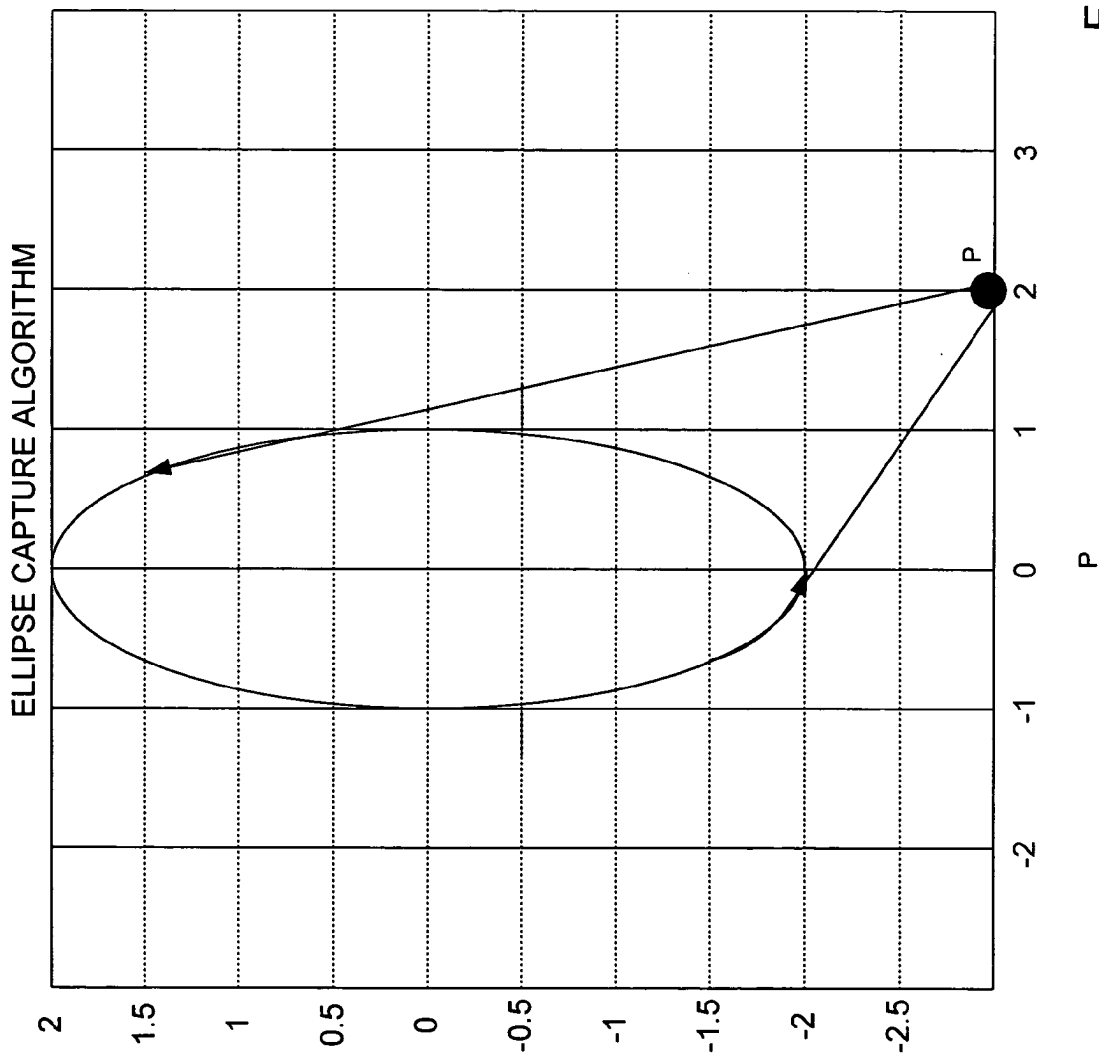

FIG. 18

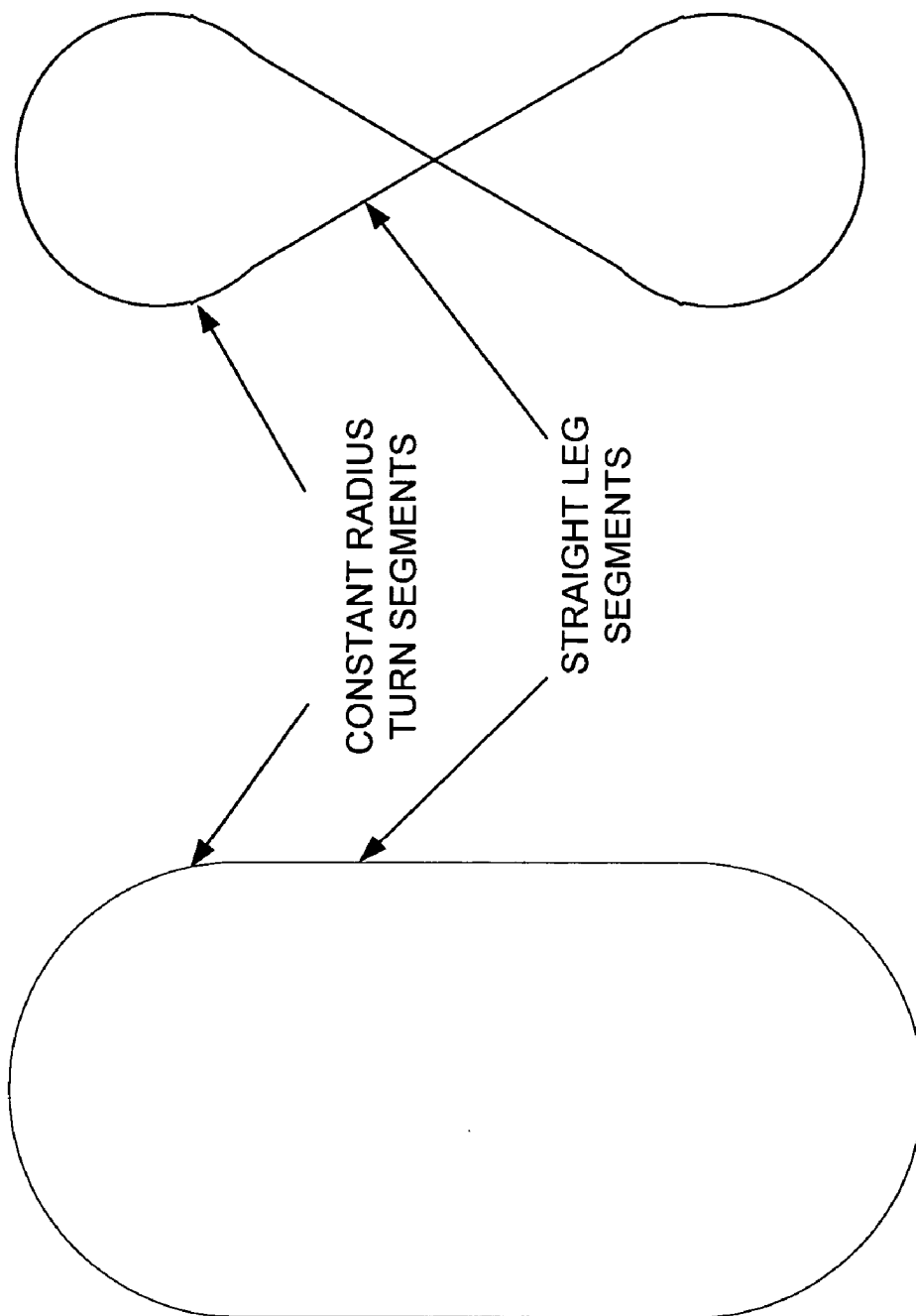

FIG. 19

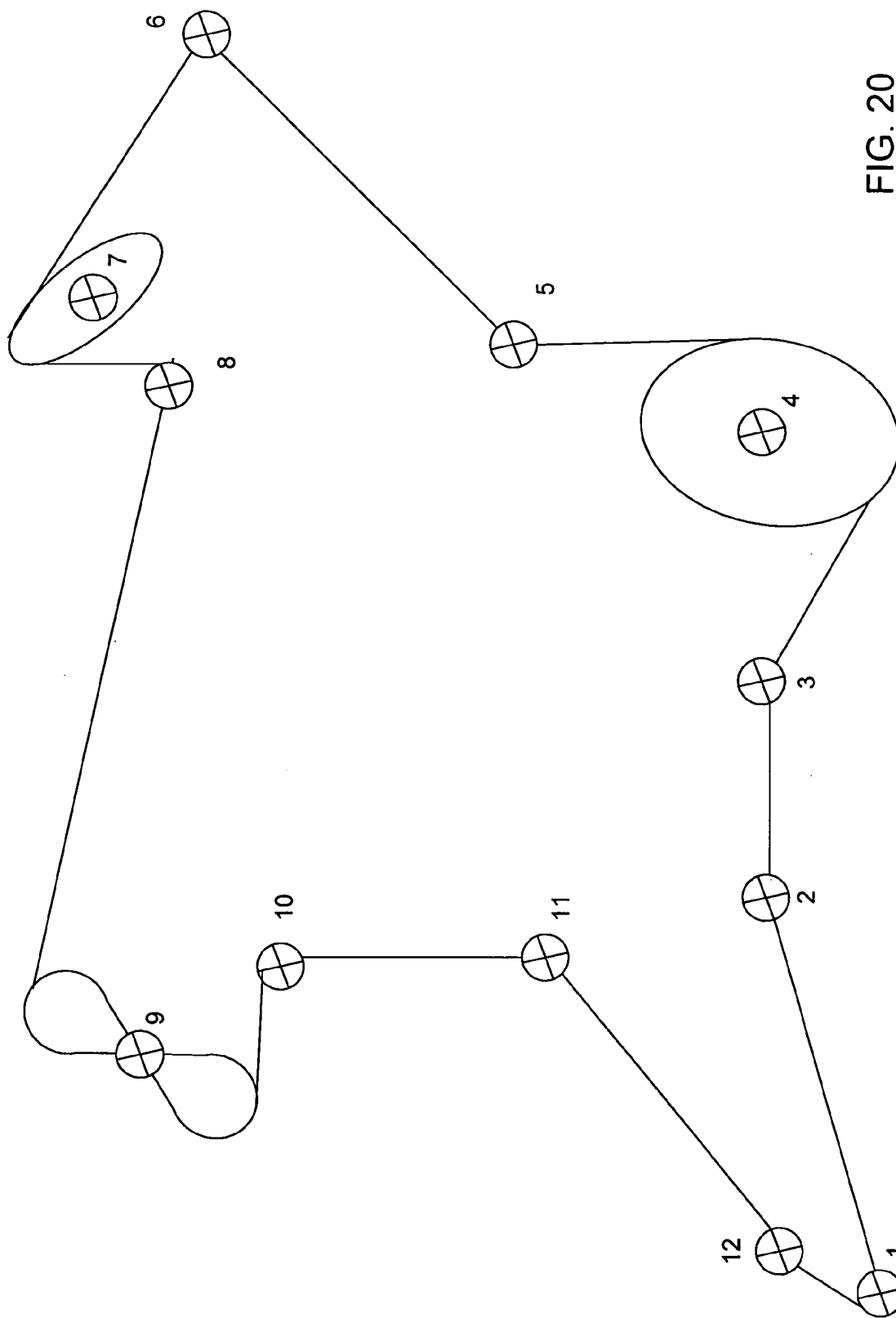

FIG. 20

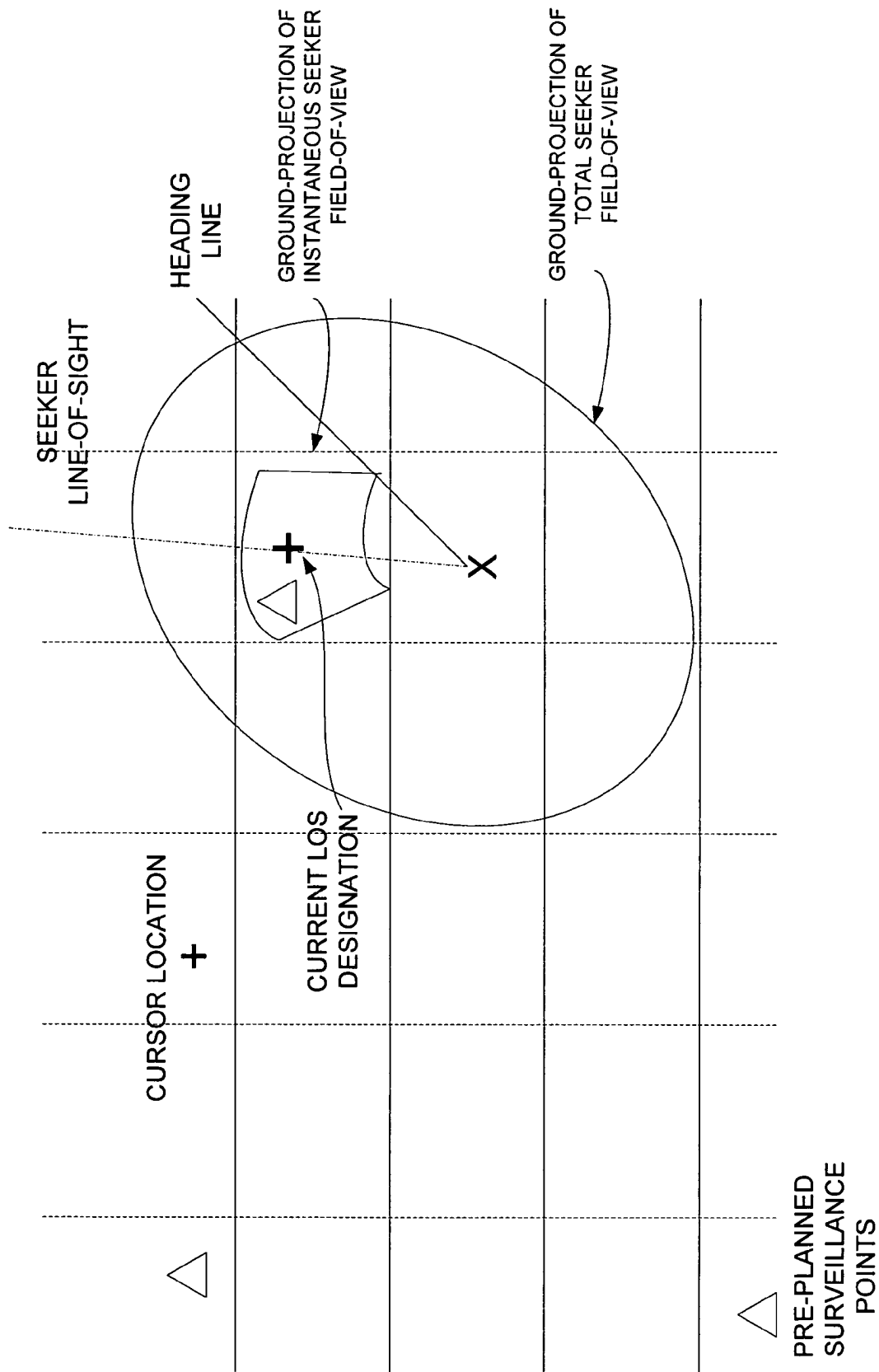

FIG. 21

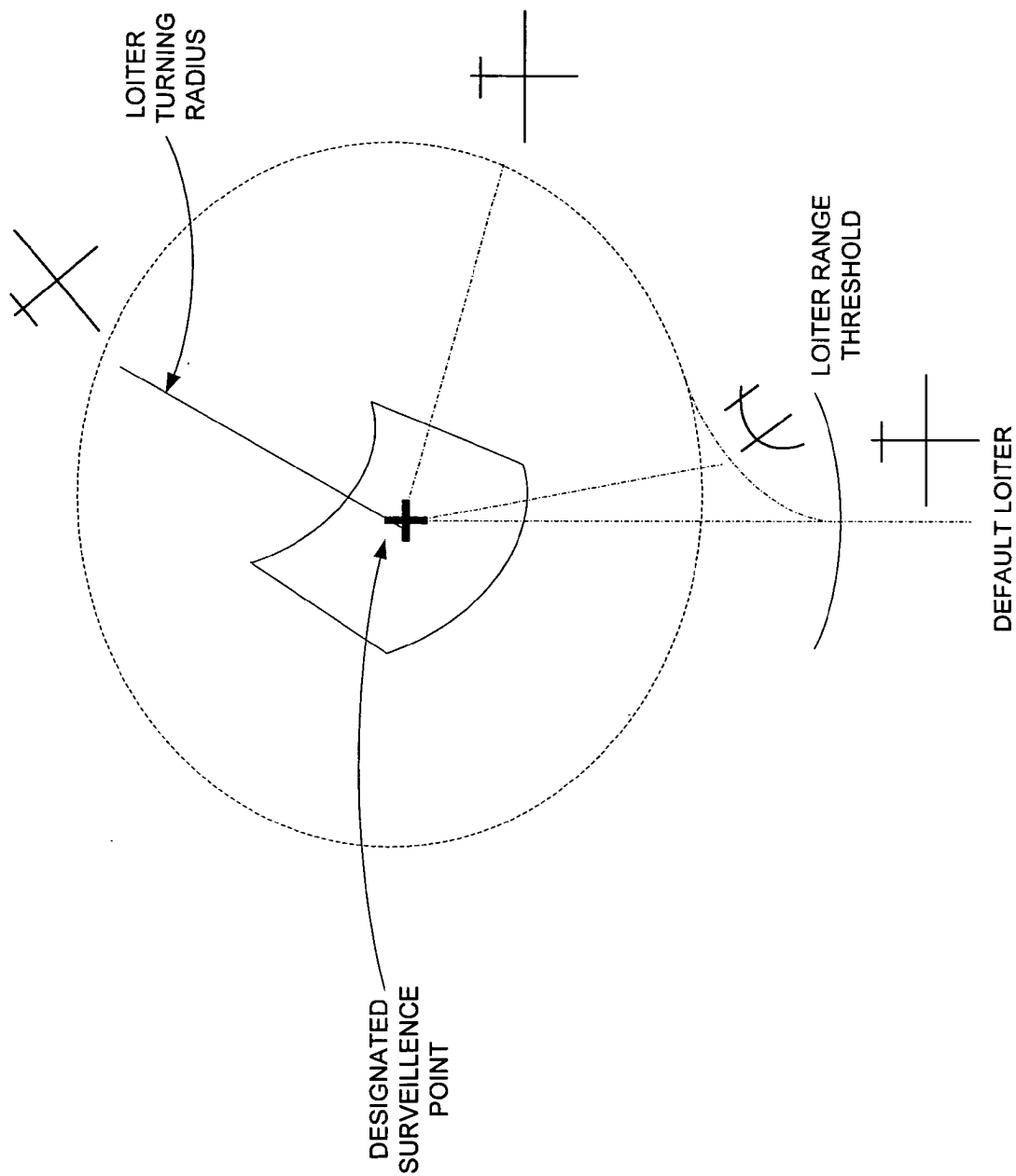

FIG. 22A

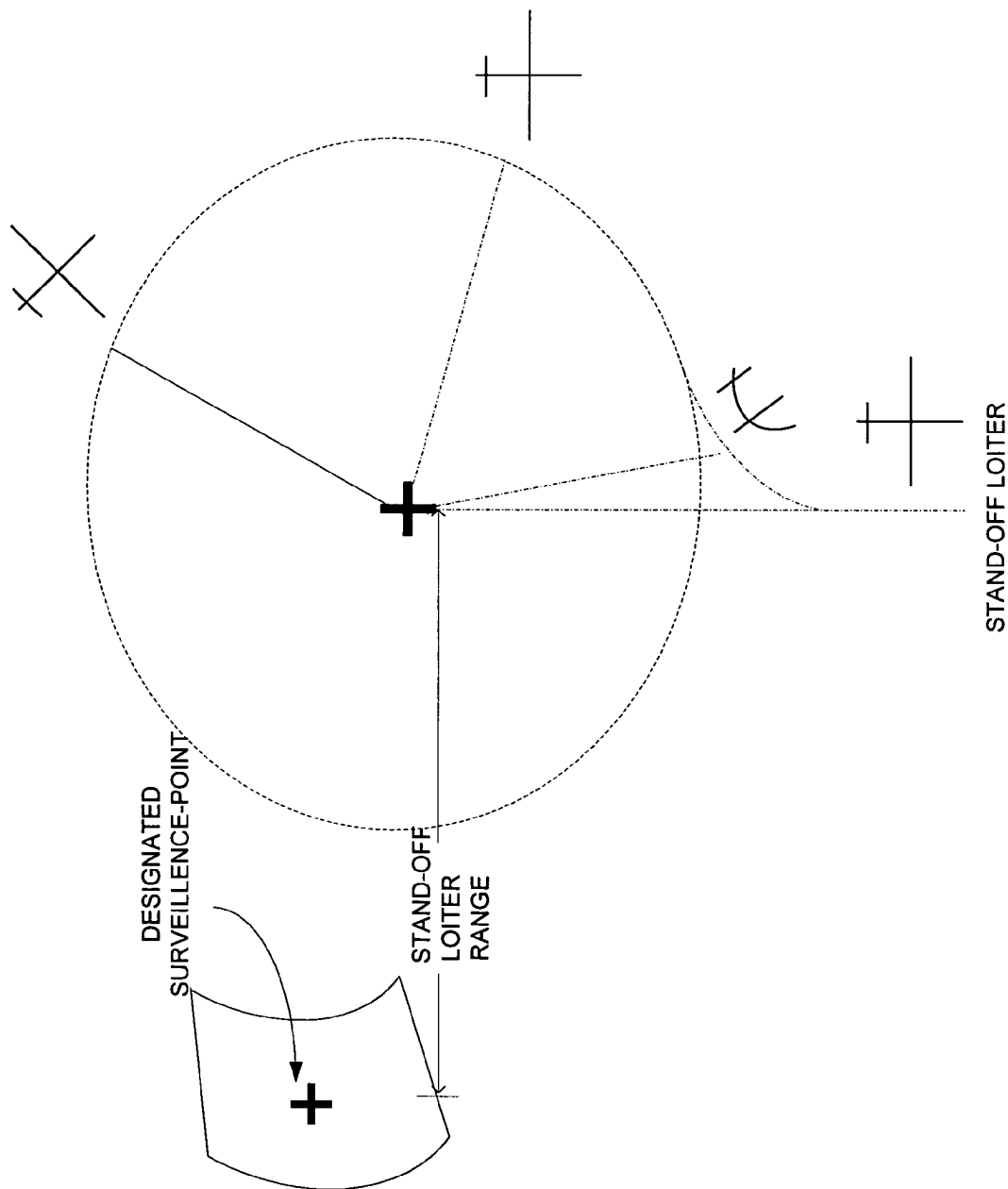

FIG. 22B



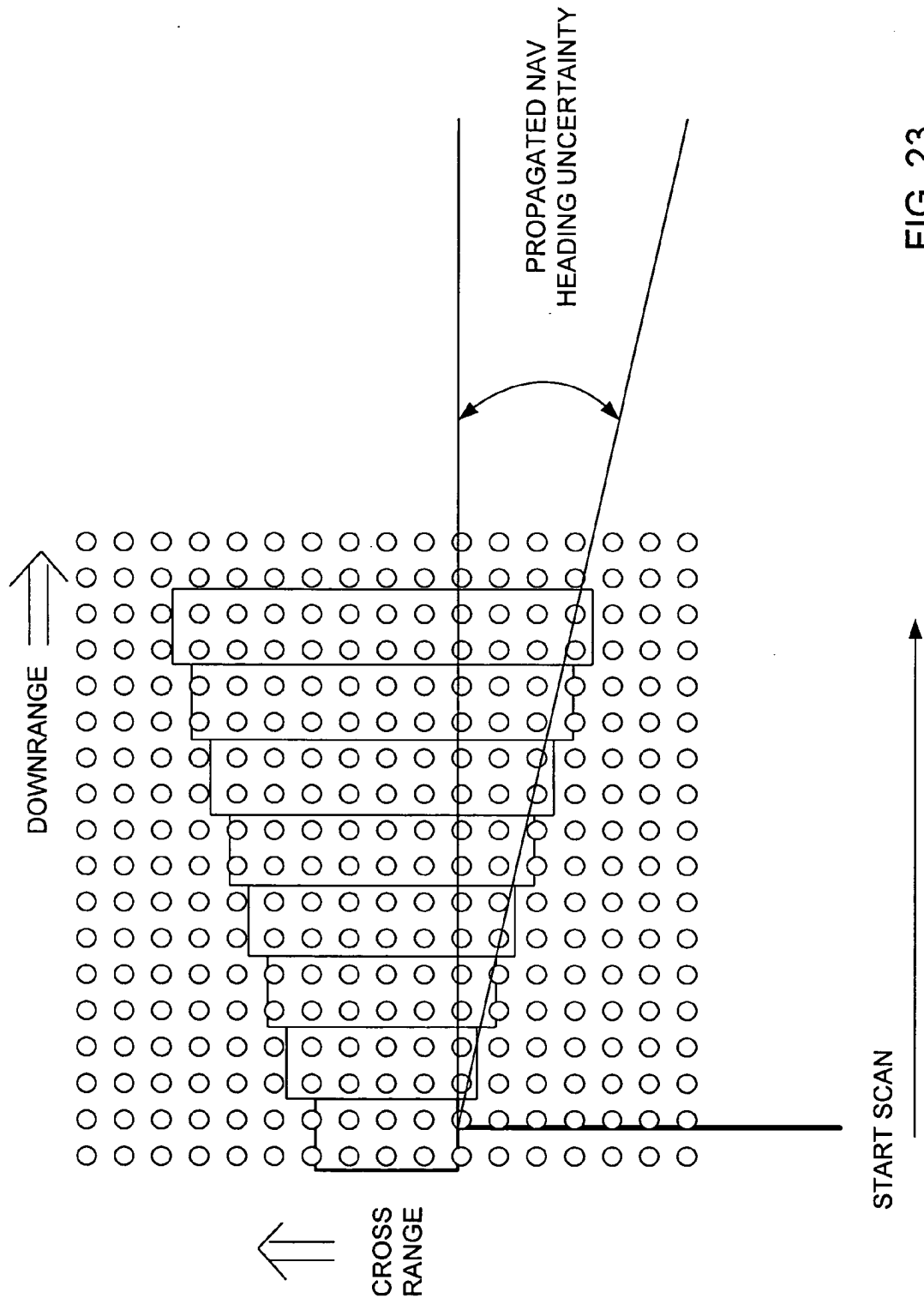

FIG. 23

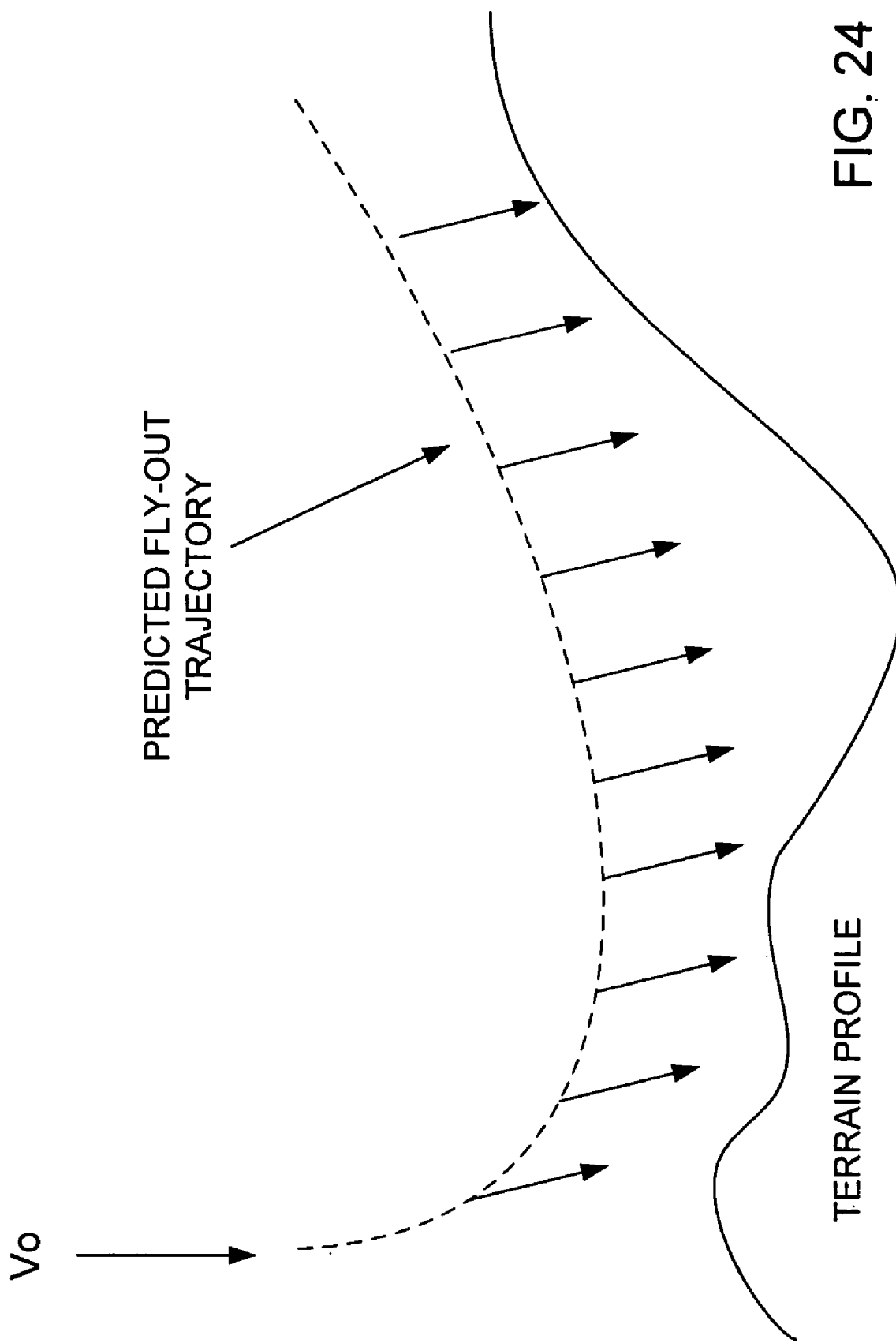

FIG. 24

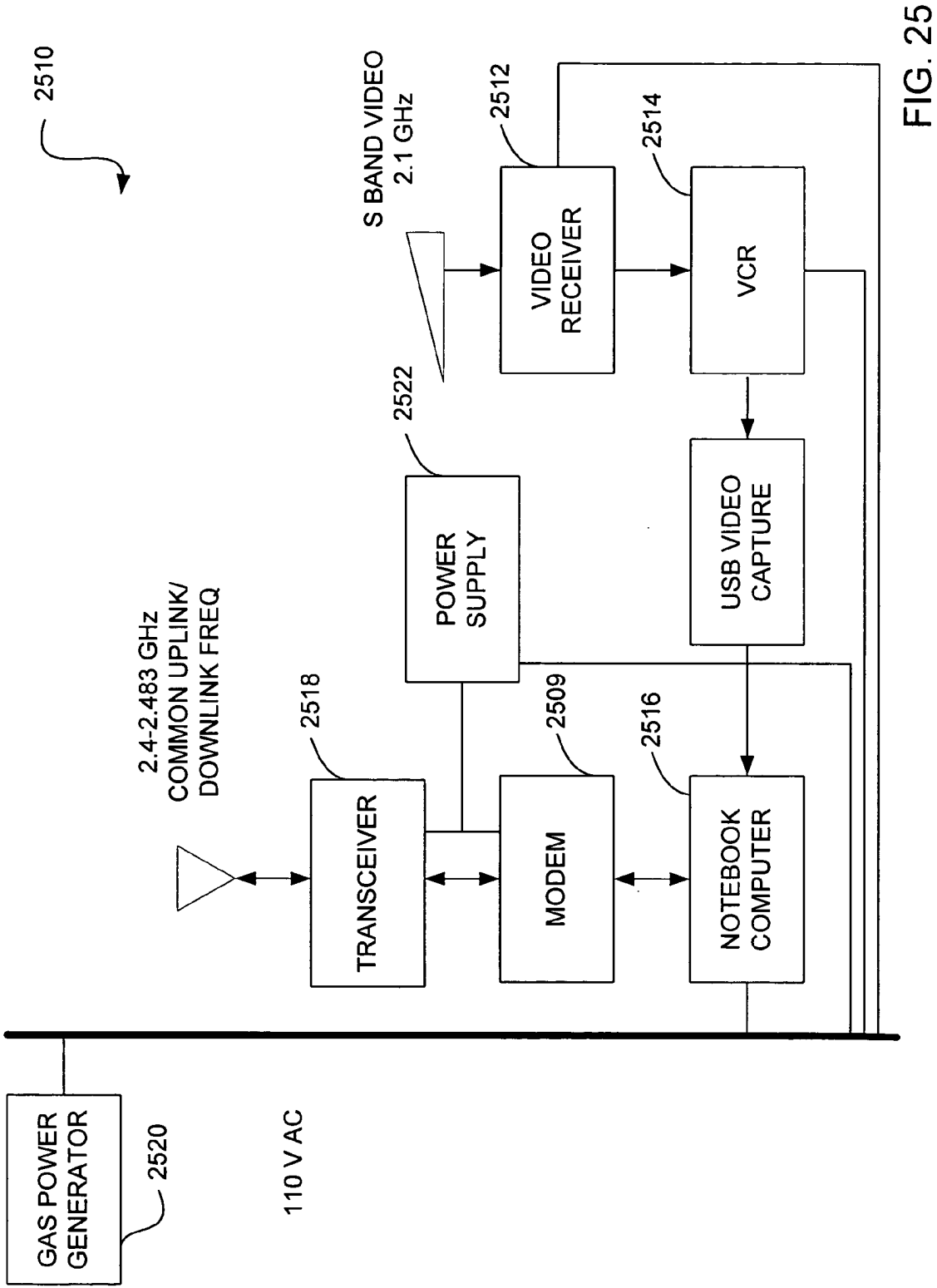

FIG. 25

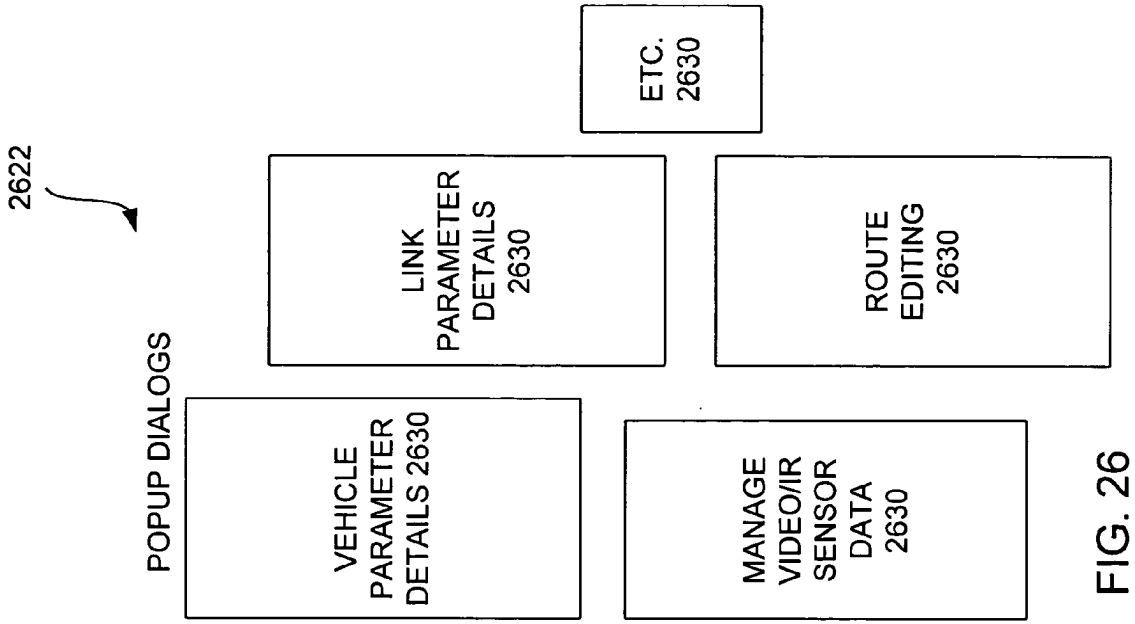

FIG. 26

WINDOW ARRANGEMENT

VEHICLE PARAMETERS DISPLAY 2626	VIDEO/IR SENSOR DISPLAY 2628
VEHICLE STATUS DISPLAY 2624	
MISSION SITUATION DISPLAY 2629	
VERTICAL PROFILE DISPLAY 2631	<u>SELECTIONS</u> 2630 - MODE MANEUVER - ROUTE -FUNCTIONS -POPUP DIALOGS

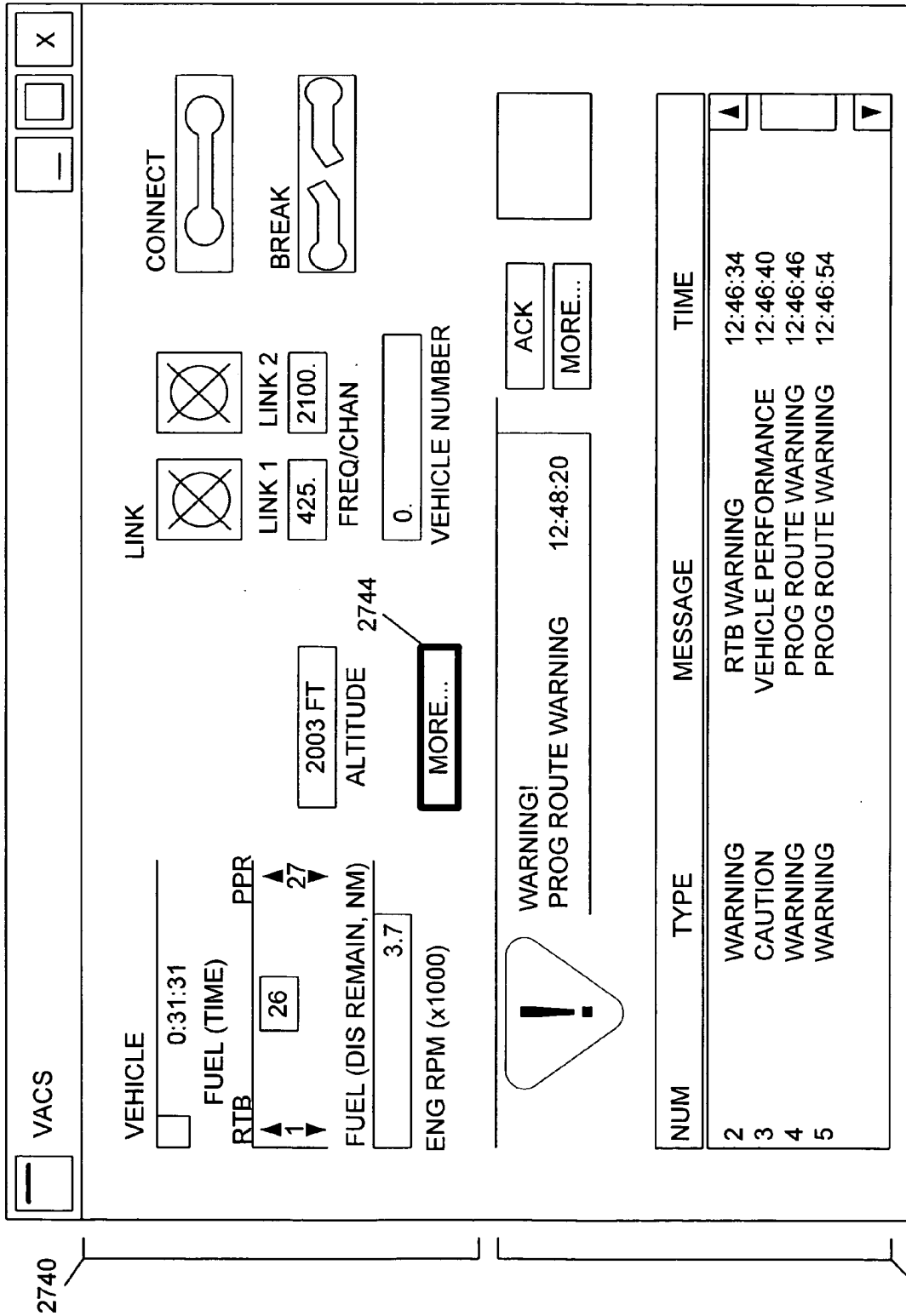

FIG. 27

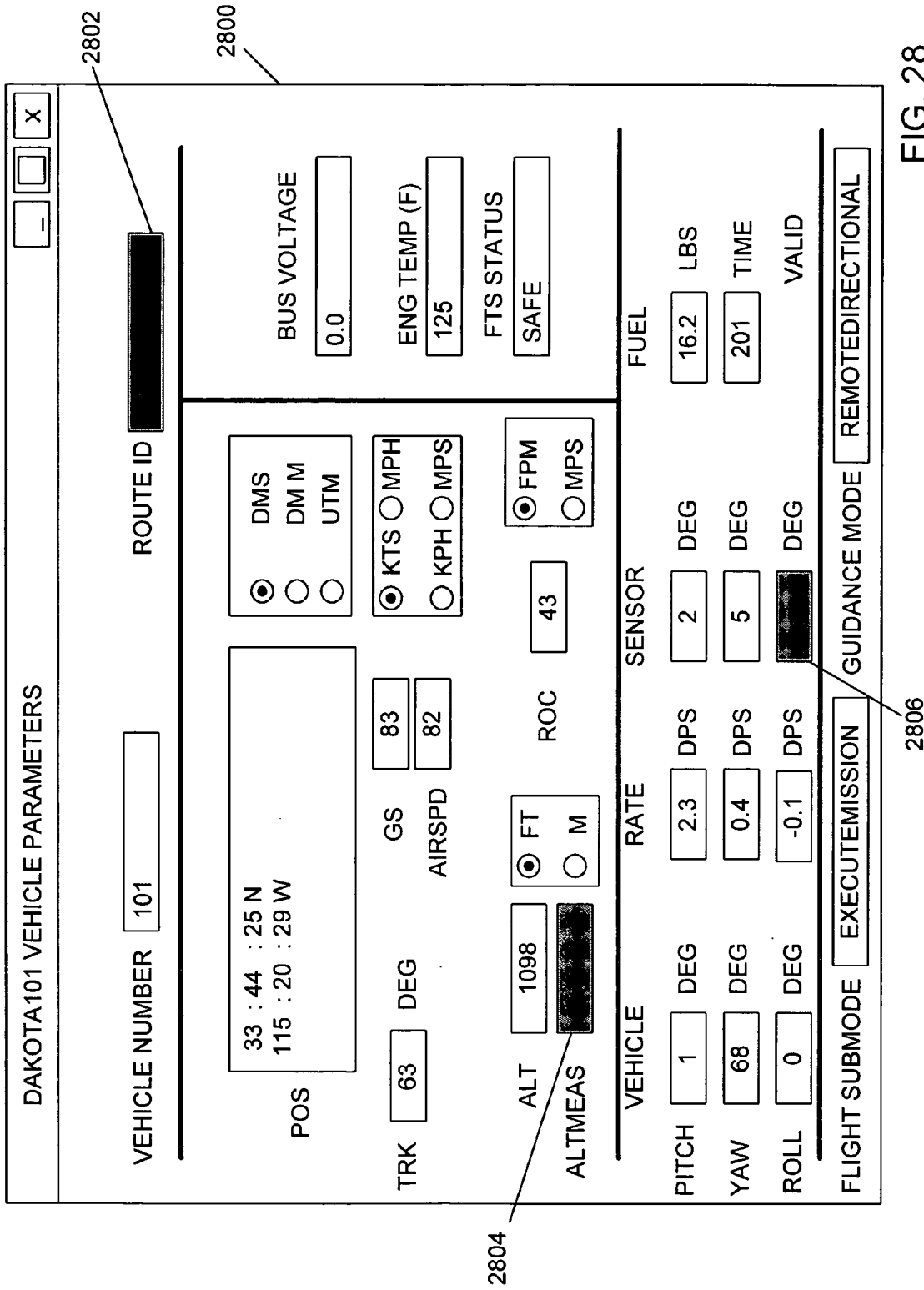

FIG. 28

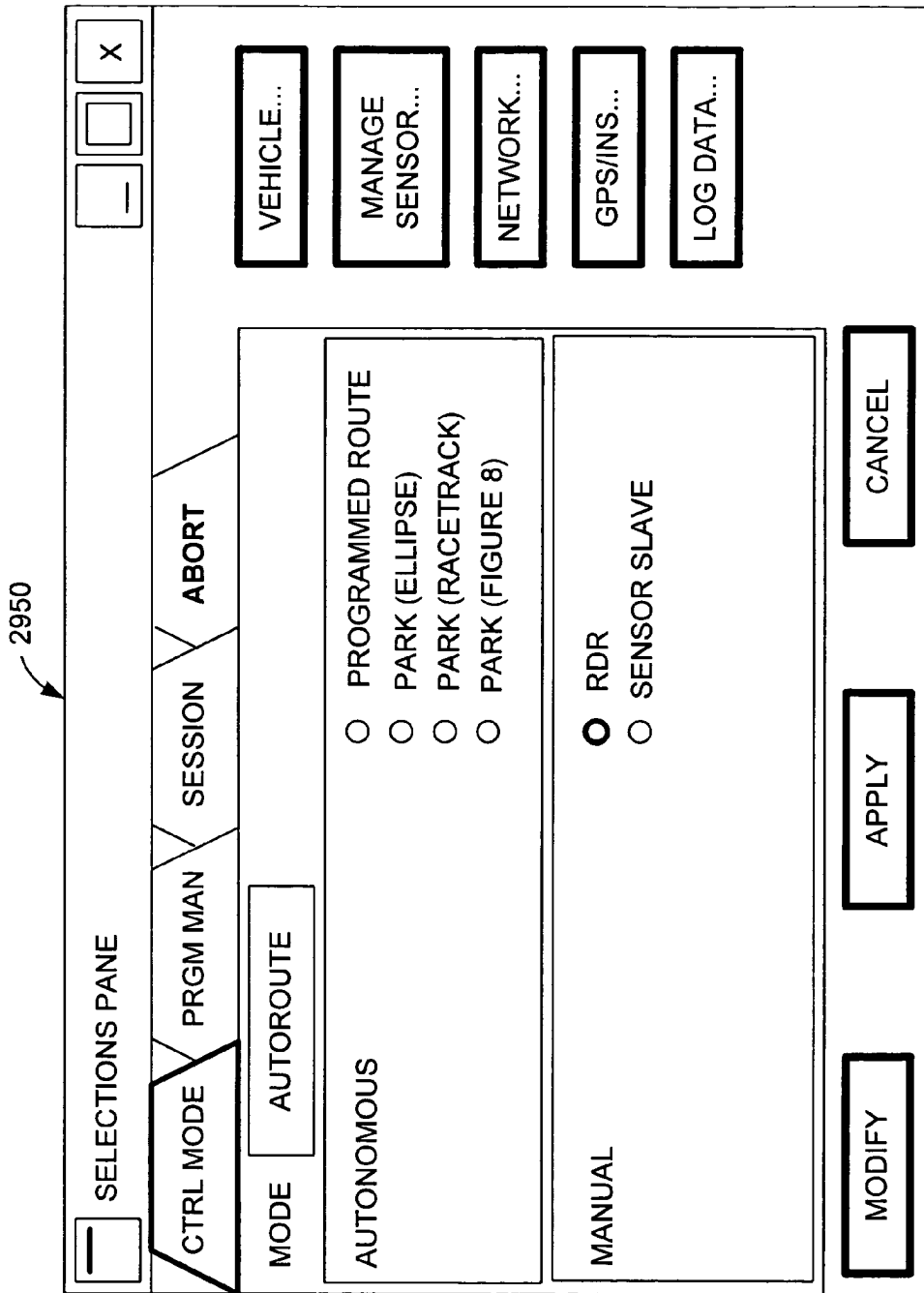

FIG. 29

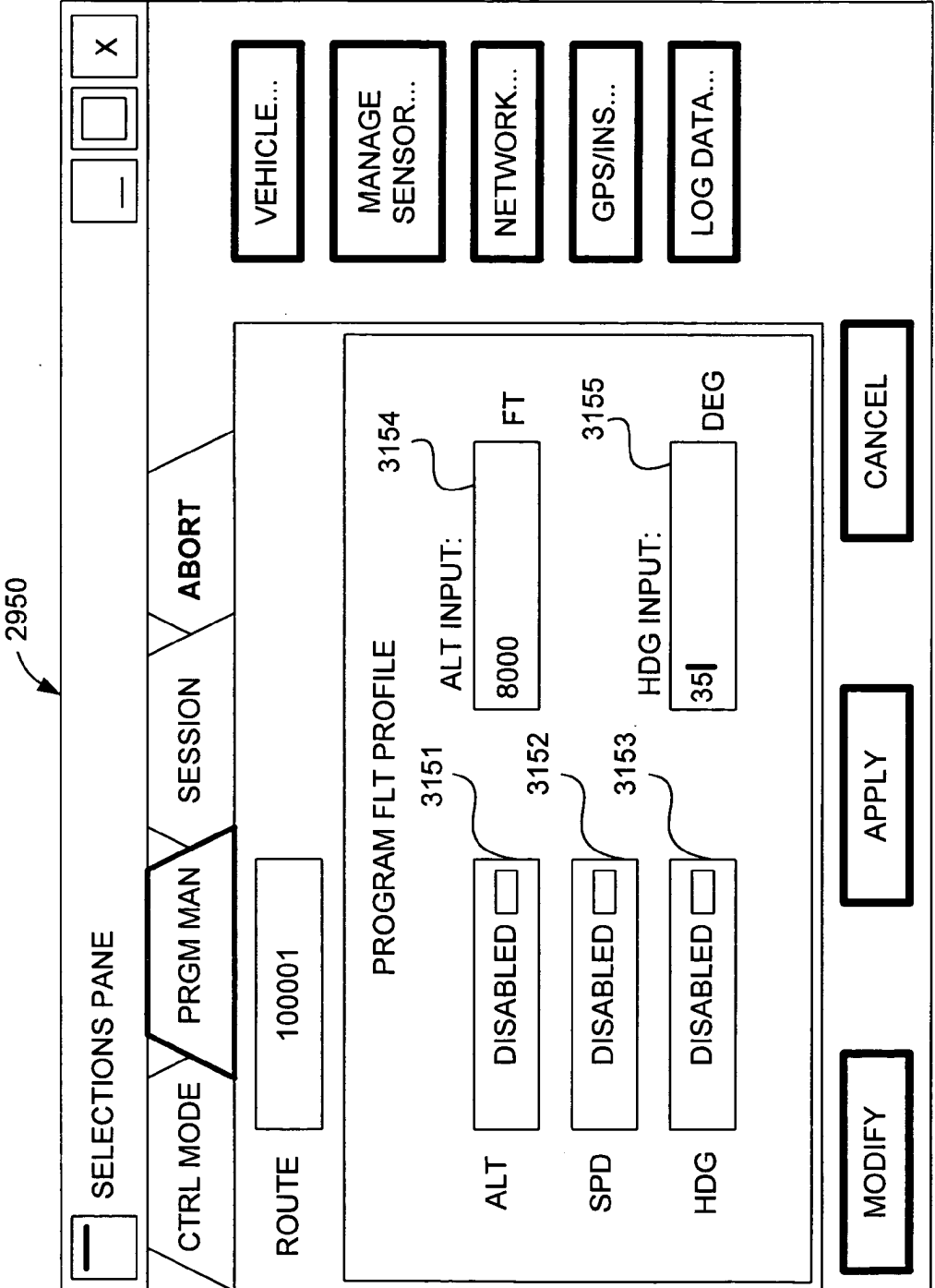

FIG. 30



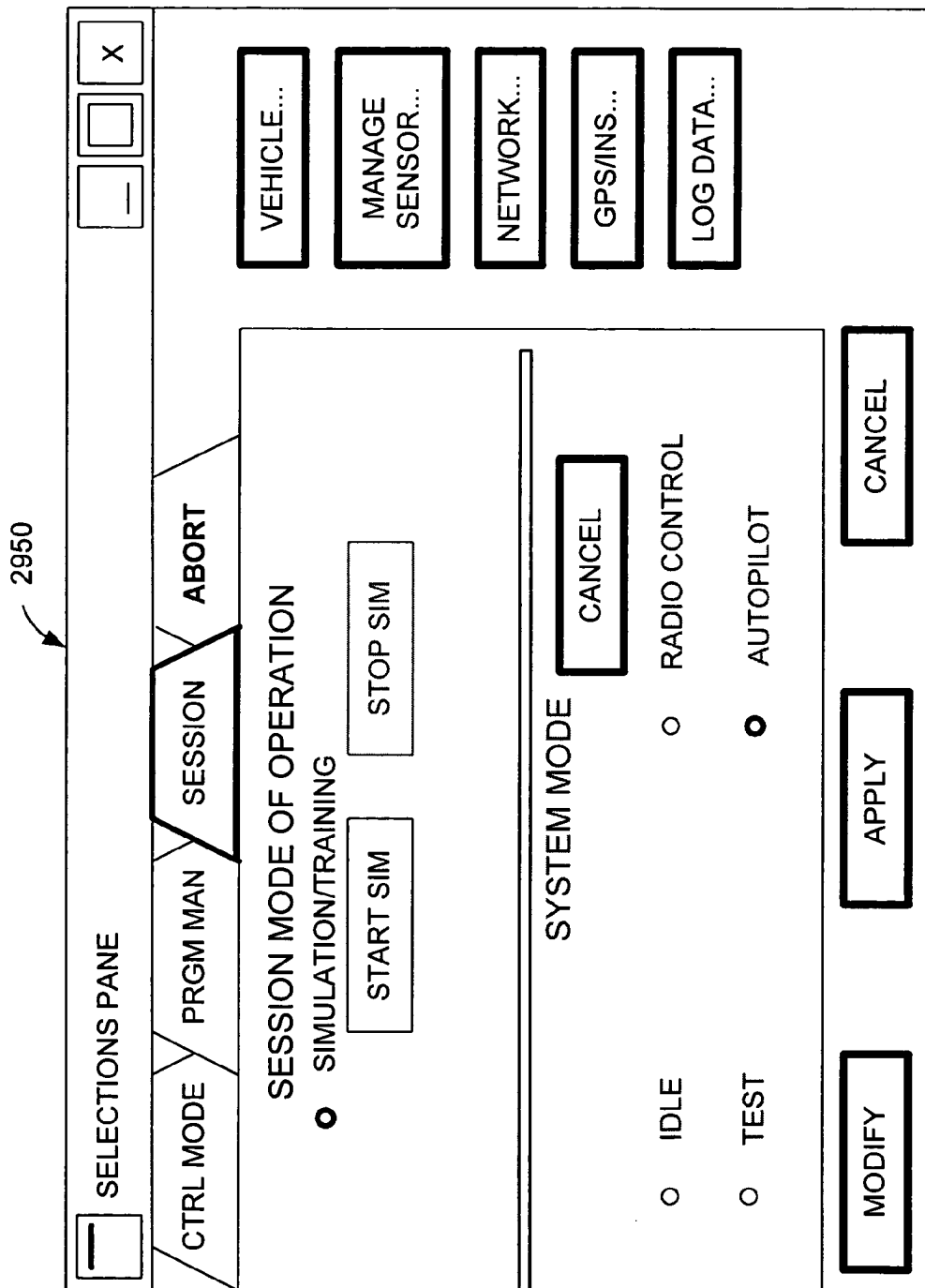

FIG. 31

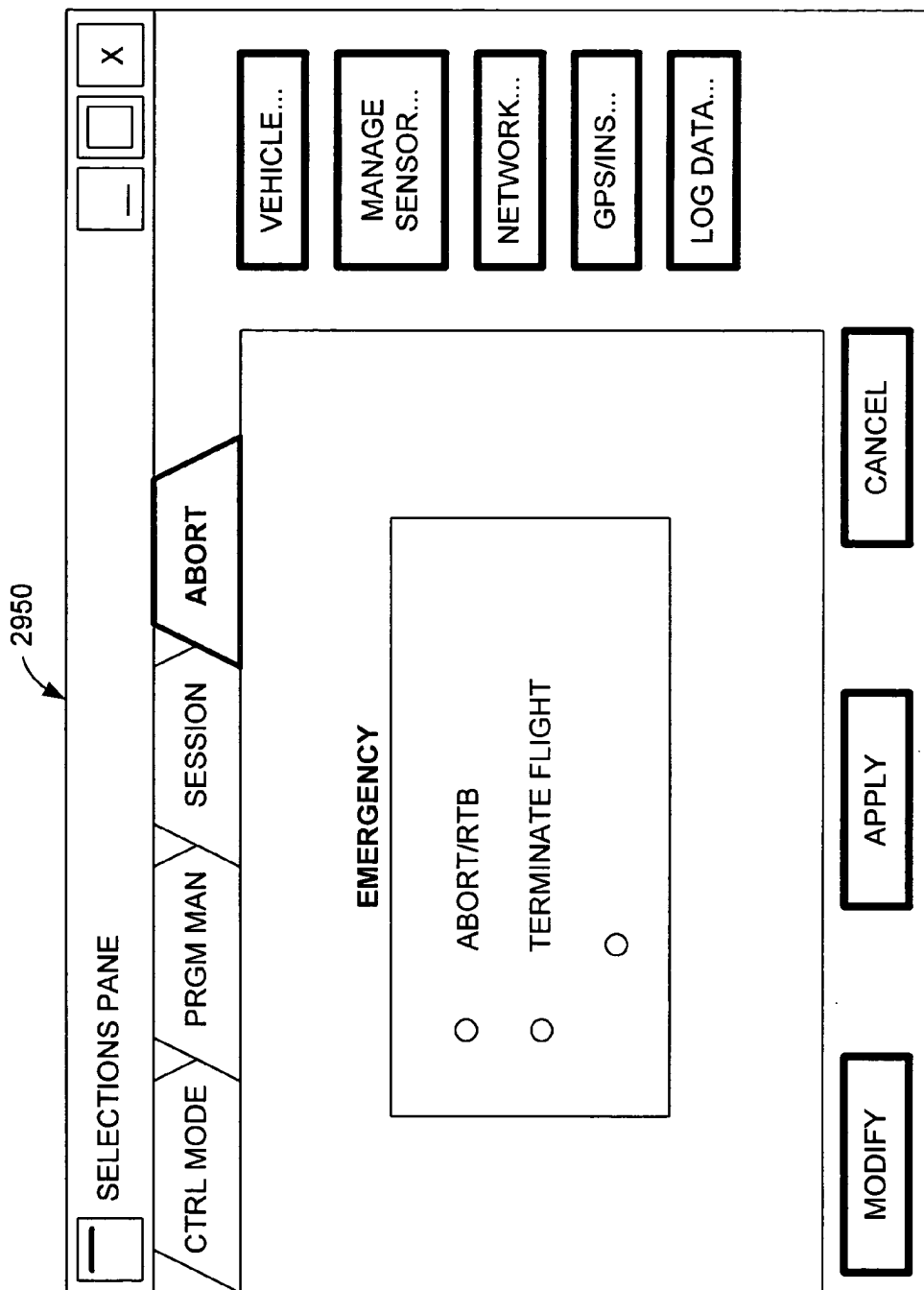

FIG. 32

ROUTE EVENT INFORMATION X

NUMBER: 3 TYPE: RACETRACK

COORDINATES

LAT	35.4352	DEG.
LON	-119.6755	DEG.

ALTITUDE  METERS MSL

LOITER

SEMI MAJOR	<input type="text" value="44.44"/>	METERS
SEMI MINOR	<input type="text" value="55.55"/>	METERS
ROTATION	<input type="text" value="270.50"/>	DEG. (0 - 360)

GRAPHIC EDIT

TYPE

- ELLIPSE
- RACE TRACK
- FIGURE 8
- TIME  # ORBITS

FIG. 33

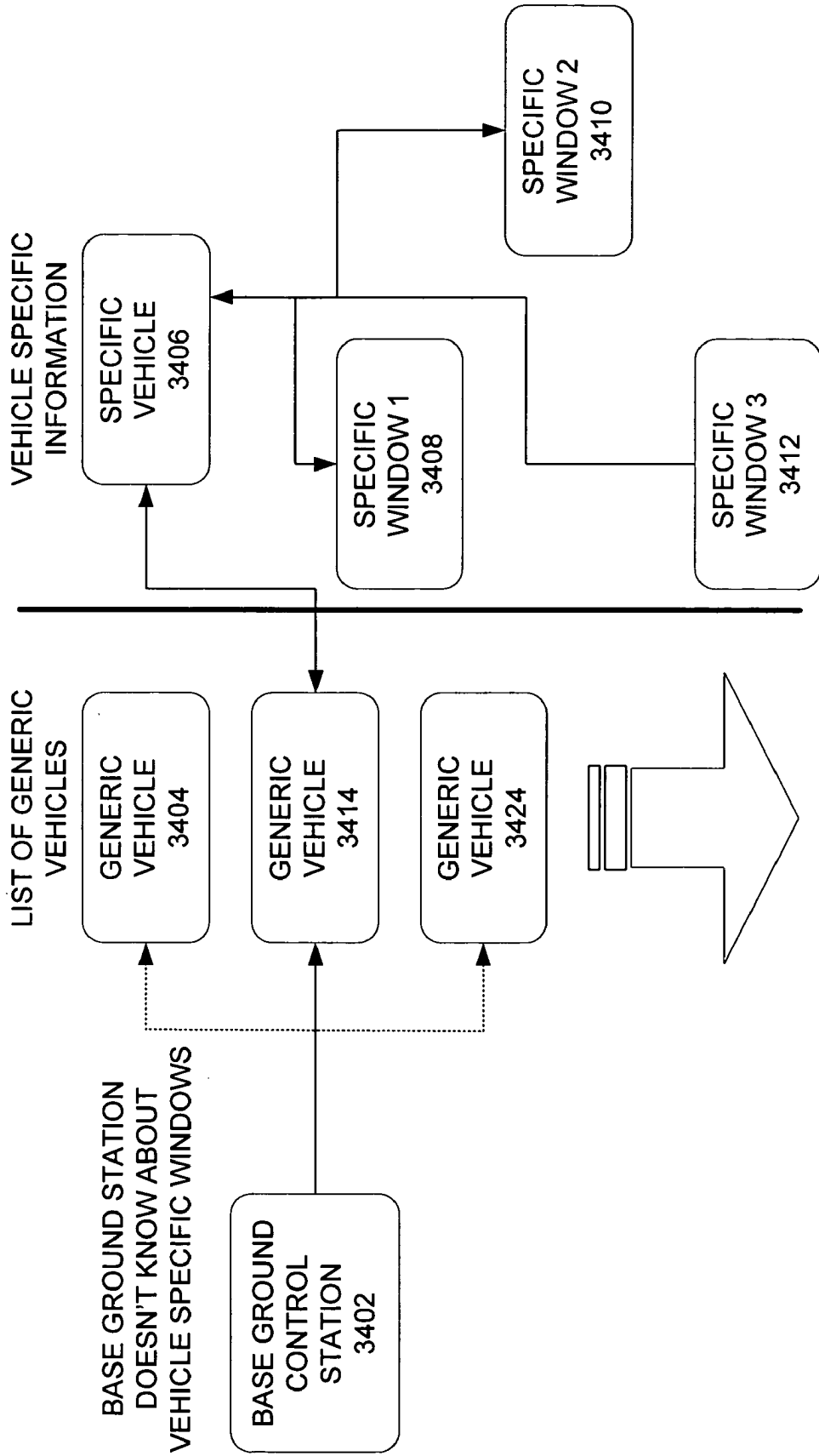

FIG. 34

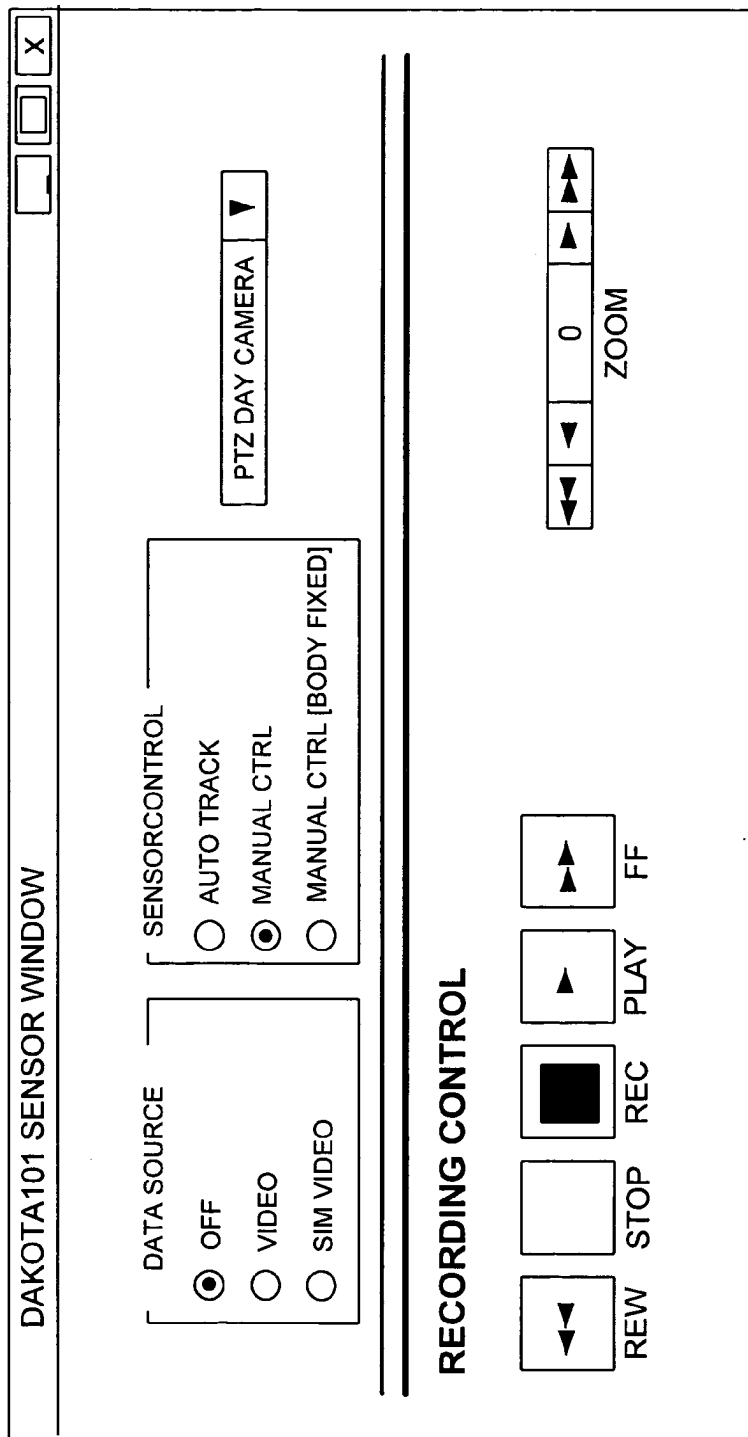

FIG. 35

DAKOTA102 SENSOR WINDOW

TAIL 2 G CAS CONTROL

ENABLE GCAS

DISABLE GCAS

MINIMUM DESCENT ALTITUDE  m

FIG. 36

GROUND CONTROL STATION									
FILE	EDIT	WINDOWS	TOOLS	CONNECT	VIEW				
CAWS DISPLAY					DAKOTA101				
0:00:00 FUEL (TIME) 0 FUEL (DIS REMAIN, NM) 1000 FT ENG RPM (x1000) 101.					3704 XMIT 2100 RCV 425. FREQ/CHAN ALTITUDE VEHICLE NUMBER				
R.C SWITCH: ACK CLEAR MSG CLEAR ALL MORE...					DAKOTA GPS STATUS WINDOW X DAKOTA101 NAV STATUS X				
DATA SOURCE <input type="radio"/> OFF <input type="radio"/> VIDEO <input type="radio"/> SUM VIDEO					SENSOR CONTROL <input type="radio"/> AUTO TRACK <input type="radio"/> MANUAL CTRL <input type="radio"/> MANUAL CTRL (BODY FIXED)				
RECORDING CONTROL <input type="checkbox"/> REW STOP <input type="checkbox"/> REC <input type="checkbox"/> PLAY <input type="checkbox"/> FF					ZOOM 3706 0				
NUM ID TYPE MESSAGE TIME					PTZ DAY CAMERA MORE APPLY CANCEL KILL SESSION DAKOTA101 VEHICLE PARAMETERS X VEHICLE NUMBER 101 ROUTE ID POS 33.44 : 52 N 115 : 19 : 27 W TRK 0 DEG GS 0 KTS MPH 0 KPH O MPS AIRSPD 3708 ALT 1000 O FT O M ALTMEAS O FPM O MPS				
MAP DISPLAY 3702									
VEHICLE RATE SENSOR FUEL PITCH 0 DEG DPS DEG 100 LBS YAW 68 DEG DPS DEG 0 TIME ROLF 0 DEG DPS DEG VALID FLIGHT SUBMODE TAXI GUIDANCE REMOTEDIRECTIONAL DAKOTA101 NAV STATUS X GPS/INS FOM INDICATORS INS SYSTEM MODE POSITION GPS MEASUREMENTS AVAILABLE VELOCITY 3710 NUMBER OF SYS IN TRACK HEADING TIME									

FIG. 37

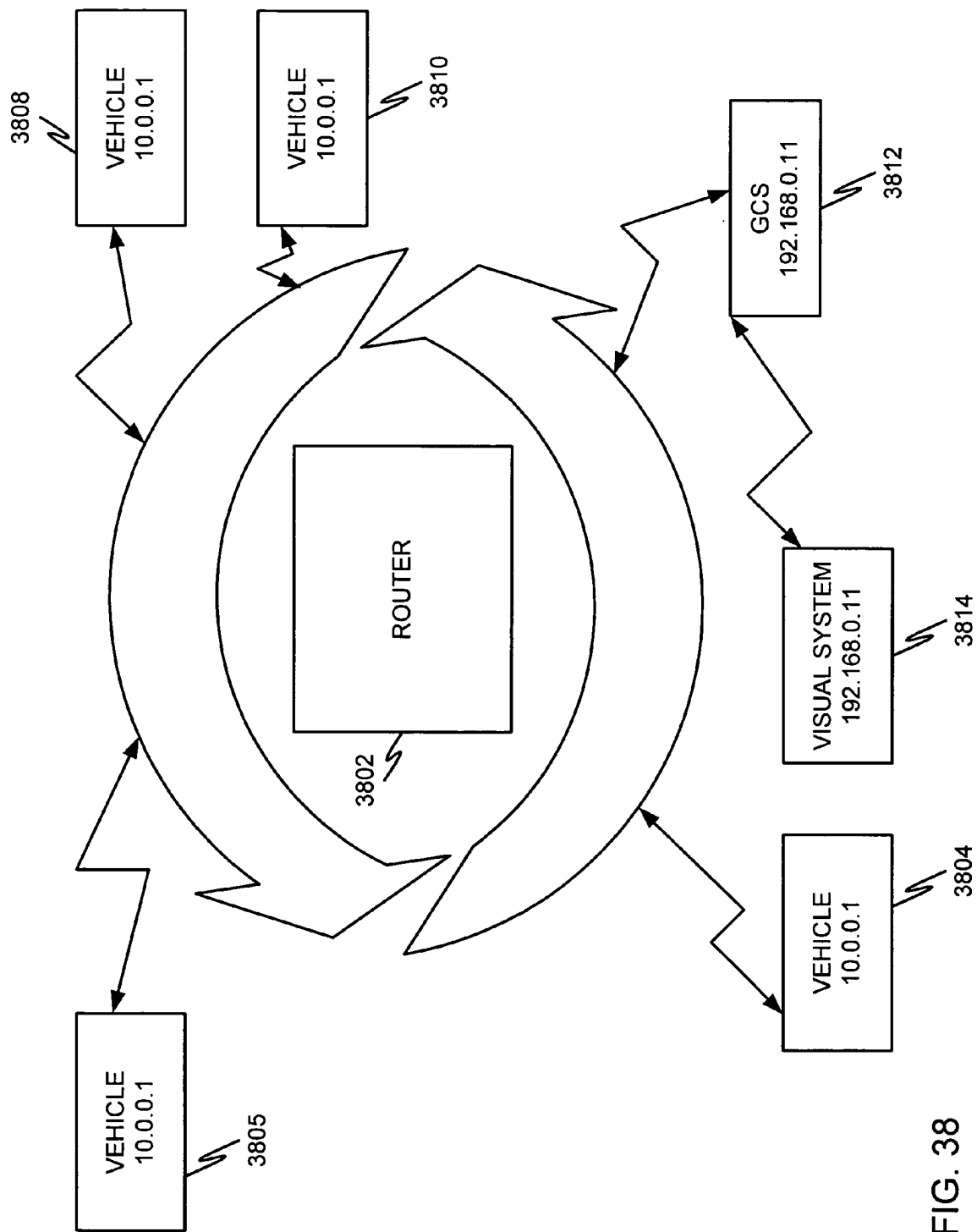

FIG. 38



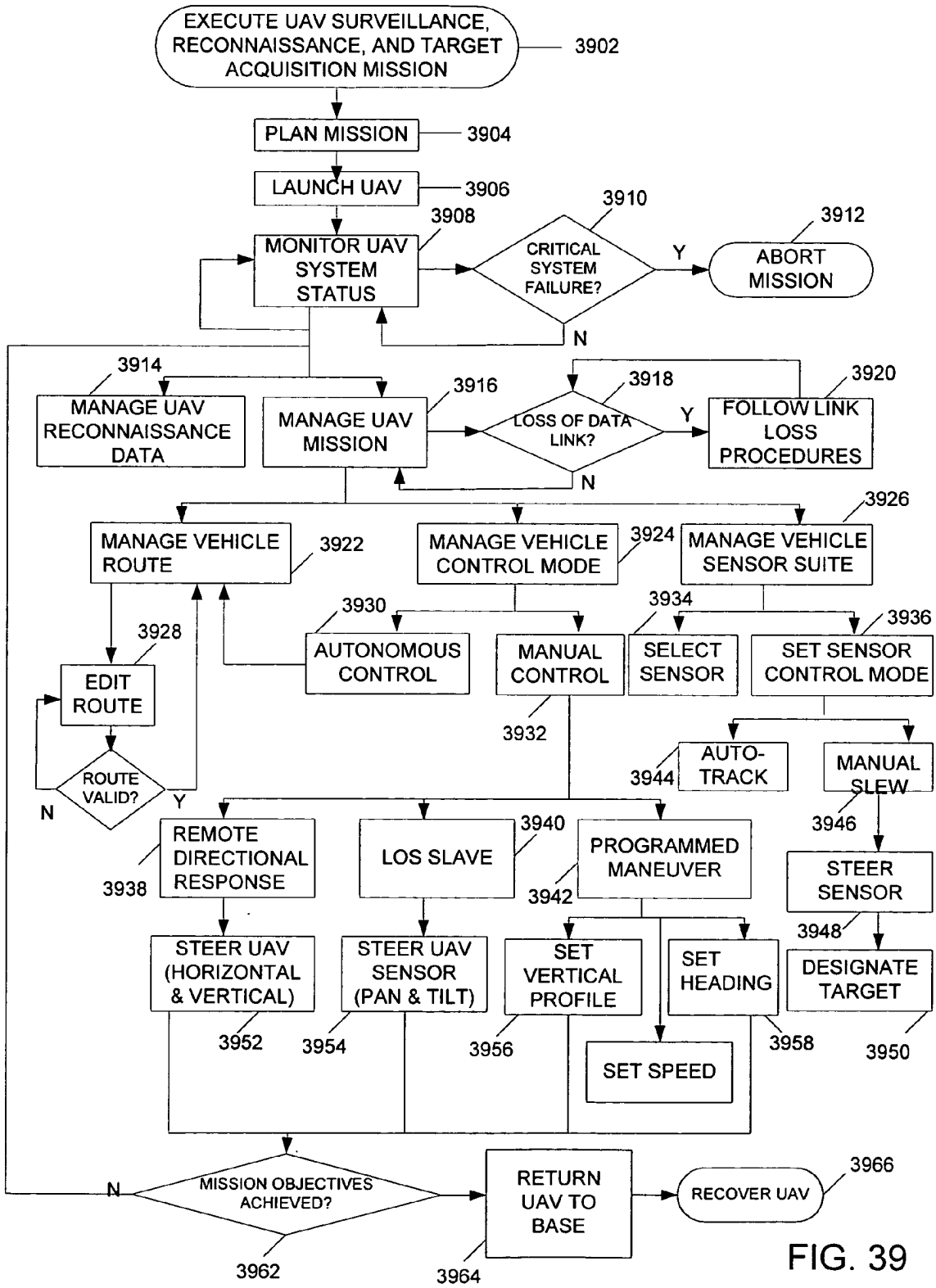

FIG. 39

**VEHICLE CONTROL SYSTEM INCLUDING RELATED METHODS AND COMPONENTS**

**RELATED METHODS AND COMPONENTS**

[0001] The present application is based on and claims the benefit of U.S. provisional patent application Ser. No. 60/480,192, filed Jun. 20, 2003, the content of which is hereby incorporated by reference in its entirety.

**BACKGROUND OF THE INVENTION**

[0002] The present invention relates to a system utilized to control a vehicle. More particularly, the present invention pertains to a variable autonomy control system that enables a human to manage and operate a vehicle through interaction with a human-system interface.

[0003] Vehicle control systems are well known in the art, one known example being a control system that enables a human operator to remotely manage and control an unmanned vehicle. In one known application, an operator remotely controls an unmanned aerial vehicle (UAV) through a human-system interface. The operator typically controls details related to payload, mission and/or flight characteristics of the unmanned aircraft.

[0004] The development of practical applications for UAV technology has been hindered by an absence of a well-integrated control and guidance system. Potential applications for UAV's include border patrol, traffic monitoring, hazardous area investigation, atmospheric sampling or even motion picture filming. All of these and other UAV applications would benefit from a control system that enables a person with minimal aviation experience or manual skill to operate the vehicle. With presently known systems, the operator is rarely able to focus on payload or mission operation because he or she is consumed with the significant responsibilities associated with aircraft piloting.

[0005] In order to be truly versatile, UAV control systems should be comfortably usable by individuals with training that is focused on the requirements of a given mission or on the usability of a payload, rather than on the aviation of the air vehicle. In many cases, present systems require an individual with pilot training to engage a control system and manage mission, payload, and aviation functions simultaneously. It is not common for known control systems to be configured for the support of intuitive high level commands such as "go left", "go right", "take off", "land", "climb", or "dive". It is instead more typical that known control systems require low-level stick-and-rudder commands from the operator. Thus, there is a need for a control system that supports integration of intuitive, mission-level remote commands into a UAV guidance system, thereby significantly reducing the work load on a human operator as it pertains to vehicle aviation.

[0006] Known control systems are generally not configured to support multiple levels of autonomous operation. In fact, few systems even offer autonomous or semi-autonomous mission capability packaged with an ability to remotely interrupt the mission. Thus, for known systems, the workload of the operator is generally too great to enable him or her to fly multiple UAV's from a single ground control station, which is an appealing possibility. Thus, there is a need for a flexible vehicle control and management concept that will operate even when responding to remote intuitive commands such that one person can operate multiple vehicles from the same control station.

[0007] Known UAV control systems typically offer limited real-time control capability or they require management by rated pilots. It is known for systems to have a capability to automatically follow pre-planned mission routes. However, it is common that real-world missions fail to go exactly as planned. For example, time-critical targets or surveillance objectives can pop up during the mission; traffic conflicts with manned aircraft can occur; clouds can get in the way of sensors (e.g., EO/IR sensors); or intelligent and devious adversaries can make target location and identification difficult. Real-time control is required to deviate from the planned route to find and identify new targets; to maneuver UAV's to avoid traffic; to fly under the weather; or to get better line-of-sight-angles. Skilled pilots can maneuver aircraft, but then an additional operator is typically necessary to manage sensors and/or the dynamic mission.

[0008] While commercialized products such as video games and CAD utilities now provide an excellent model for human interfaces, such interfaces have generally not been completely integrated into an actual vehicle control system. In fact, very few known UAV autopilot systems are readily compatible with known Commercial Off-The-Shelf (COTS) hardware. This is unfortunate because it is not uncommon for non-pilot trained individuals to be pre-equipped with a familiarity with such hardware that includes standard joysticks, track-balls, lap-top computers, virtual reality head mounted displays and glove input devices.

[0009] Known vehicle control systems generally do not include an operational mode that enables an operator to focus his or her attention on a tactical situation display (e.g., images transmitted from an onboard sensor) rather than providing directional commands based primarily on a control interface. Such a control mode has many potential advantageous applications, for example, an operator can command the scope of the vehicle's on-board sensor to survey a battle field (or other topographical region) while the vehicle autonomously commands a flight profile that is slaved to the operator's sensor line-of-sight commands. There is a need for an integrated guidance solution that adapts to such a mode of control.

[0010] Advances in virtual reality simulation graphic display technology have made the concept of a virtual reality interface to real-time systems feasible. Already used by surgeons in the medical community, the use of virtual reality, such as Telepresence or Mixed Reality systems, in the context of UAV control is now feasible but generally unknown. Thus, there is a need for a control system that provides an operator with functionality that takes advantage of this new technology.

[0011] Finally, many known control systems are not adaptable to on-going command-and-control software development efforts. For example, for military applications, it is desirable that a control system be equipped to operate within the advanced Command Control Communication Computers and Intelligence (C4I) infrastructure and interface with associated Common Ground Control Stations such as the Joint STARS Common Ground Station. It is desirable that guidance software have the capability not only to respond to the command interface, but also an ability to be expanded modularly as new capabilities are desired, such that expansions can be accomplished without significant changes in the interface.

**SUMMARY OF THE INVENTION**

[0012] Embodiments of the present invention pertain to a vehicle control system that includes an integrated guidance

design and systems engineering approach that enables a system having a modular core structure. The core structure enables the control system to be conveniently upgraded or updated. For example, the control system can be easily extended to accommodate increasing and/or additional guidance, payload or other technology. Further, the core structure enables the system to be efficiently adapted for various manned and/or unmanned vehicles.

[0013] Embodiments of the present invention also pertain to a vehicle control system and related sub-components that together provide an operator with a plurality of specific modes of operation, wherein each mode of operation incorporates a different level of autonomous control. Through a control user interface, an operator can smoothly switch between modes of operation even after vehicle deployment. Specialized autopilot system components and methods are employed to ensure seamless transitions between operational modes. Empowered by the multi-modal control system, an operator can even manage multiple vehicles simultaneously.

[0014] Embodiments of the present invention pertain to a hierarchical control system, user interface system, and control architecture that together incorporate a broad range of user-selectable control modes representing variable levels of autonomy and vehicle control functionality. A unified autopilot is provided to process available modes and mode transitions. An intelligence synthesizer is illustratively provided to assist in resolving functional conflicts and transitioning between control modes, although certain resolutions and transitions can be incorporated directly into the functional sub-components associated with the different control modes. In accordance with one embodiment, all modes and transitions are funneled through an acceleration-based autopilot system. Accordingly, control commands and transitions are generally reduced to an acceleration vector to be processed by a centralized autopilot system.

#### BRIEF DESCRIPTION OF THE DRAWINGS

- [0015] FIG. 1 is a schematic block diagram illustrating a variable autonomy control system.
- [0016] FIG. 2 is a schematic representation of a human-based command and control loop.
- [0017] FIG. 3 is a diagrammatic block representation of a hierarchical control structure.
- [0018] FIG. 4 is a simplified diagrammatic representation of a control structure.
- [0019] FIG. 5 is a diagrammatic block representation of a control system incorporating a translation layer.
- [0020] FIG. 6 is a schematic representation of top-level software objects associated with system interface components of a control system.
- [0021] FIG. 7 is a schematic representation of an interface system for the control of multiple vehicles.
- [0022] FIG. 8 is a schematic diagram representing a vehicle control scheme.
- [0023] FIG. 9 is a control diagram representing a general integrated guidance loop structure.
- [0024] FIG. 10-1 is a diagrammatic representation of an ECEF coordinate frame definition.
- [0025] FIG. 10-2 and 10-3 are diagrammatic representations of a geodetic coordinate frame definition.
- [0026] FIG. 10-4 is a schematic representation of a body reference frame.
- [0027] FIG. 11 is a schematic block diagram demonstrating a basic flow structure for various flight mode levels.
- [0028] FIG. 12 is a schematic diagram demonstrating waypoint guidance error calculation.
- [0029] FIG. 13 is a schematic diagram demonstrating the effect that the earth's curvature can have on calculations.
- [0030] FIG. 14 is a schematic diagram demonstrating altitude error calculation.
- [0031] FIG. 15 is a schematic diagram demonstrating one aspect of waypoint leg transition.
- [0032] FIG. 16 is a schematic diagram demonstrating a vehicle turn.
- [0033] FIG. 17 is a schematic diagram defining parameters and coordinate frames used to support an elliptical loiter guidance law.
- [0034] FIG. 18 is a schematic chart demonstrating that for any point P outside of an ellipse there exist two lines passing tangent to the ellipse and containing the point P.
- [0035] FIG. 19 is a schematic diagram demonstrating segments associated with racetrack and figure-8 patterns.
- [0036] FIG. 20 is a schematic diagram demonstrating an example of a programmed route using various loiter algorithms.
- [0037] FIGS. 21, 22A & 22B are schematic diagrams demonstrating features of a line-of-sight-slave control approach.
- [0038] FIG. 23 is a schematic illustration of a scan process in the context of a ground collision avoidance system.
- [0039] FIG. 24 is a schematic diagram illustrating a fly-out trajectory in the context of a ground collision avoidance system.
- [0040] FIG. 25 is a simplified block diagram of a ground control station.
- [0041] FIG. 26 is a block diagram representation of an example graphical user interface display.
- [0042] FIG. 27 is a sample screen shot representation of a vehicle status display.
- [0043] FIG. 28 is an example screen shot representation of an intelligent window display.
- [0044] FIGS. 29-33 are examples of pop-up window displays.
- [0045] FIG. 34 is a schematic diagram demonstrating a generic vehicle class system configuration.
- [0046] FIGS. 35 & 36 are examples of vehicle-specific window displays.
- [0047] FIG. 37 is an example screen shot representation of a graphical user interface.
- [0048] FIG. 38 is a schematic block diagram demonstrating a network centric UDP communications scheme.
- [0049] FIG. 39 is a schematic block diagram illustrating potential control paths through a mission.

DETAILED DESCRIPTION OF ILLUSTRATIVE EMBODIMENTS

[0050] I. Introductory Comments

[0051] Much of the present invention description will be devoted to describing embodiments in the context of an unmanned aerial vehicle (UAV). However, it is to be understood that the embodiments generally pertain to vehicle control systems and are designed for broad application. The embodiments can be adapted by one skilled in the art to be applied in the context of any of a variety of unmanned vehicles including, but not limited to, airplanes, helicopters, micro air vehicles (MAV's), missiles, submarines, balloons or dirigibles, wheeled road vehicles, tracked ground vehicles (i.e., tanks), and the like. Also, embodiments of the present invention can be adapted by one skilled in the art to be implemented in the context of manned vehicles (e.g., a human passenger operates the control system, or a human remotely operates a control system for a vehicle that transports a passenger, etc). It should be noted that the relatively modular nature of the vehicle control system of the present invention enables the adaptations necessary to accommodate different vehicles to be made in a relatively small period of time.

[0052] Certain embodiments of the present invention pertain to specialized control subsystems that each individually enable a specific control functionality to be accessed through the larger control system. It is to be understood that such subsystems can be adapted and independently deployed even in the context of vehicle control systems other than those specifically described herein. Also, such subsystems can be adapted to support any type of manned or unmanned vehicle including, but not limited to, those specifically listed herein.

[0053] II. Overview—Variable Autonomy Control System Architecture

[0054] Embodiments of the present invention generally pertain to a variable autonomy control system (VACS) architecture that enables, among other characteristics, a general simplification of UAV operation and control. The architecture illustratively supports selectable levels of control autonomy from fully autonomous control to simplified manual flight control modes for enhanced real-time control.

[0055] As dependence on UAV's for military operations grows and UAV technology is integrated into the emerging global command and control architecture, the cost and complexity of managing and controlling these assets could easily become substantial. This limitation is brought about by either of two extremes in the vehicle command and flight control philosophy: complete dependence on a human-in-the-loop (fully manual control) or complete exclusion of a human-in-the-loop (fully autonomous control). The former requires a dedicated, highly trained operator whereas the latter provides no mechanism for real-time operator interaction or mission management. The need for a dedicated highly-trained operator drives costs (personnel and training requirements) and severely limits a single operator's flexibility in that he or she is primarily focused on the aviation of the vehicle rather than the higher level mission objectives. On the other hand, the exclusion of the human-in-the-loop drives logistics costs (mission planning and asset allocation) and severely limits the UAV's operational flexibility.

[0056] A control design consistent with embodiments of the present invention exploits existing flight control tech-

nologies to arrive at an ideal balance between the two above-described control philosophies. The control design includes a flight control structure that supports variable levels of control autonomy and minimizes personnel and training requirements for vehicle operation. Human factors play a key role in that the vehicle is treated as one of many assets (e.g., including other vehicles) available to an individual operator during the execution of a defined mission. Therefore, the vehicle must be easily controllable. Embodiments of the present invention reflect the philosophical notion that a truly enabled UAV operator should not be required to be a trained aviator but should still retain variable levels of control capability to execute mission objectives that call upon his/her specialized expertise.

[0057] Embodiments of the present invention pertain to a hierarchical flight control structure with varied levels of remote operator input combined with an off-board controller software package and intuitive human system interface. Research of problems related to UAV control has indicated that a good solution lies in the appropriate functional allocation between human and machine. In the context of embodiments of the present invention, this leads to segregation of control into two fundamental categories: flight control and flight management. Flight control associates with the aviation of the aircraft whereas flight management associates with the mission plan (navigation tasking) for the aircraft.

[0058] III. Details—VACS Architecture

[0059] FIG. 1 is a schematic block diagram illustrating a VACS architecture 100 in accordance with one aspect of the present invention. Architecture 100 incorporates a hierarchical design that enables an invocation of different control behaviors at various levels in the hierarchy. Primitive control functions are combined with complex autonomous functions to enable a broad range of behaviors. An operator is illustratively able to access and selectively invoke certain of the control behaviors through an intuitive interface, such as an interface made available through a workstation. In accordance with one embodiment, the architecture design enables a single operator to work through the interface to effectively control multiple vehicles simultaneously.

[0060] FIG. 1 includes a spectrum 102 that demonstrates the hierarchical nature of architecture 100. Inputs 106 from human and other external sources are characterized across spectrum 102. At the top of the spectrum is the objective/decision level 104. Level 104 represents the highest end of the control spectrum wherein autonomous control is maximized, and the level of intelligent interaction (e.g., interaction with a human or other systems) consists of higher-level objective-based planning. The lowest level of intelligent autonomy is the execution level 112, in which external command interaction is either directly proportional to the actuation or is minimally compensated.

[0061] In between ends 104 and 112 are mission level 108 and coordination level 110. Levels 108 and 110 are sub-levels of the spectrum and represent varying levels of a blending of external and automated functionality. Mission level 108 is more human-oriented than coordination level 110, which is more human-oriented than execution level 112. Conversely, execution level 112 is more autonomous in nature than coordination level 110, which is more autonomous in nature than mission level 108.

[0062] Architecture **100** includes a plurality of functional sub-components **120-146**. With regard to the **FIG. 1** depiction, it should be noted that the individual functional sub-components are not necessarily illustrated on the level where they would correspond to the illustrated spectrum **102**. Spectrum **102** is provided simply to demonstrate a hierarchical structure underlying architecture **100**. Functional sub-components **120-146** represent control behaviors available for invocation either automatically or based on operator selection inputs.

[0063] When the illustrated control system architecture is actually applied, two or more of the illustrated functional sub-components can be applied simultaneously to accomplish a unified control scheme. In addition, in accordance with one embodiment, an operator is provided with the capability to interact through an interface to activate and deactivate certain functional control sub-components in order to activate and deactivate different modes of operator control representing different levels of system autonomy. An intelligence synthesizer **150** is provided to coordinate applicable functional sub-components and resolve conflicts there between. For example, if a vehicle is autonomously tracking a target (sub-component **130**) and a new control command is inserted to automatically avoid an air collision (sub-component **122**), then it is illustratively up to intelligence synthesizer **150** to determine which control source is to be given priority. Assumedly, collision avoidance will be given priority. Following execution of collision avoidance, intelligence synthesizer **150** is illustratively configured to resume normal operation (e.g., resume target tracking, hold a reasonable heading, etc.). In another example, if an operator interrupts the tracking of a target with an instruction to switch to autonomous route following (sub-component **132**), then intelligence synthesizer **150** will ensure that the switch between modes of control is carried out as smoothly and efficiently as possible.

[0064] In accordance with one embodiment, intelligence synthesizer **150** is configured to manage the interfaces between modular autonomous and semi-autonomous functions so that they can be integrated in a 'plug-n-play' format. Some functions require de-confliction between competing commands to the airframe, on-board sensors, or outer-loop guidance. The intelligence synthesizer is illustratively configured to determine what functions exist in the configuration, what functions have priority, what functions are dormant, and what functions do not exist in the configuration. The intelligence synthesizer is illustratively further configured to implement the VACS hierarchical architecture to manage which level autonomy is allocated to each function. With reference to the **FIG. 1** architecture hierarchy, the lowest level Execution functions are implemented with direct interfaces to the airframe and payload hardware. These functions illustratively include an airframe body-rate stabilization loop, an airframe acceleration command-tracking loop, a bank-angle command tracking loop, and/or a collection of payload management functions (these and other applicable functions are commercially available for integration and/or are described in other sections below as embodiments of the present invention). The higher level functions have interfaces as well, and in some cases will illustratively share responsibility with Coordination Level functions. Examples of such functions include implementation of inertial trajectories, pre-programmed maneuvers such as racetrack loiter patterns, waypoint leg regulation and

switching, management of a waypoint list, and management of semi-autonomous control functionality such as sensor slave and remote-directional control (these and other applicable functions are commercially available modules for integration and/or are described in detail below in other sections as embodiments of the present invention).

[0065] The Coordination level functions illustratively share responsibilities with some Mission level functions. Examples of mission-level functions are autonomous route planners, autonomous ground collision avoidance, and autonomous see-and-avoid (these and other applicable functions are commercially available modules for integration and/or are described in detail below in other sections as embodiments of the present invention). Generally speaking, these functions process mission-level requirements and implement them based on vehicle state and mission status information.

[0066] In accordance with one embodiment, autonomous and semi-autonomous functions illustratively communicate and coordinate with each other via intelligence synthesizer **150**, which is a pseudo-bus and communications manager. In cases where autonomous commands conflict or interfere with each other, intelligence synthesizer **150** determines how to de-conflict, blend, or prioritize the output commands.

[0067] A payload control functional sub-component **144** is included in order to facilitate transfers of information to and from mission payload **160**. Mission payload **160** is illustrated with a variety of payload components **162-176**. The illustrated payload components are illustrative only in that other or different components could be included without departing from the scope of the present invention. Some of the payload components are sensors that gather data that is transferred to intelligence synthesizer **150** either for the purpose of serving as a reference to be utilized in a vehicle control scheme or, alternatively, to be collected for some inherent value of the information itself (e.g., collected for a mission-oriented purpose). One illustrative purpose for communication payload component **174** is to facilitate communication between a ground station and a corresponding system implemented on the remote vehicle. Embodiments of the present invention pertain to specific communications components and will be described in greater detail below in other sections. Weapons payload component **176** is an example of an active component that can be triggered (e.g., fired) in response to operator input. Many of the illustrated payload components will be described in greater detail below. Chemical-biological detector component **172** is illustratively a sensor for detecting chemical and/or biological substances, for example for the purpose of identifying areas contaminated by chemical or biological agents. The GPS/IMU component **170** is illustratively a vehicle motion identification component for generating vehicle location information for any purpose such as, but not limited to, vehicle guidance, navigation or to be viewed by the operator (these and other applications of the data provided by sensor **170** will be described below in greater detail). Camera component **164** gathers information for mission purposes and/or for control purposes (the latter purpose being an embodiment of the present invention that will be described in detail below in other sections). Optical tracker **162** is illustratively configured to track an airborne or ground-based object relative to the vehicle for control purposes (e.g., air collision avoidance, ground target tracking, air target tracking, etc.) or

mission purposes. Components **166** and **168** support additional mission and/or control functionality. Component **166** facilitates data collection and transfer of information in the nature of radar data, SAR data, ISAR data or the like. Component **168** could be any of a variety of components but illustratively facilitates data collection and transfer of information in the nature of a radar emitting device configured to sense and locate ground objects and the like.

[0068] The VACS architecture **100** illustratively enables a man-in-the-loop (i.e., the operator) to intuitively assign and deploy one or more UAV's in accordance with available control behavior parameters. The architecture supports intuitive control characteristics that are illustratively based on the human learning and decision-making process. Accordingly, the available control behavior parameters are designed to emulate the human learning, decision-making, and action processes. The architecture is distributed by design so that appropriate learning, decision-making and action behaviors are resident onboard the vehicle and supported with autonomous functionality when necessary.

[0069] It should be emphasized that the present invention is not limited to the illustrated sub-components **120-146**. In fact, in accordance with one embodiment of the present invention, architecture **100** is designed such that additional sub-components can be modularly plugged into control architecture **100** to extend the system functionality. When a new sub-component is installed, intelligence synthesizer **150** is illustratively configured to recognize and manage the new functionality (e.g., synthesizer **150** is configured to manage conflicts with other sub-components, etc.).

[0070] FIG. 2 is a schematic representation of a human-based command and control loop **200** as is emulated in the VACS architecture **100**. For reference purposes, FIG. 2 includes the same intelligent controller hierarchy spectrum **102** that was illustrated in FIG. 1. At the highest end of the spectrum, objectives **202** (e.g., typically human defined such as reconnaissance, surveillance, tracking, monitoring, etc.) provide a fundamental basis for the subsequent support levels. The lower levels of activity will illustratively be influenced by the overarching objectives. For the machine or vehicle, the fundamental equivalent of objectives **202** is machine constraints **204** (e.g., aviation limitations of the vehicle, available payload components, communications limitations such as range, static and dynamic limitations, etc.). The overarching machine constraints illustratively influence the lower levels of activity. In accordance with one aspect of the present invention, a human (i.e., an operator) can utilize a machine (e.g., a UAV) that is equipped with a system implementing the VACS architecture to observe (bubble **206**), orient (bubble **208**), decide (bubble **210**) and take action (bubble **212**). The steps of observe, orient, decision and action are hierarchical in nature and reflect a natural human process flow, and notably are reflected in the available coordination of autonomous functionality offered through the VACS architecture.

[0071] FIG. 3, in accordance with one aspect of the present invention, is a diagrammatic block representation of a hierarchical control structure **300**. Control structure **300** is illustratively designed to support the VACS architecture **100** described in relation to FIG. 1. Most of the functional sub-components illustrated in FIG. 1 represent a range of potential functional control capabilities incorporating differ-

ent levels of autonomy. Again, as has been discussed, the architecture is designed to be modularly extendable to even non-illustrated control schemes.

[0072] The highest level of control structure **300** is level **302**, which is identified as the trajectory control level. Level **302** represents autonomous flight control modes and functionality that basically incorporate substantially full autonomy requiring practically no operator input. For illustrative purposes, mission control **304** is included on level **302** and represents mission-oriented fully autonomous flight control (e.g., mission is automatically planned and executed).

[0073] The next level of control structure **300** is level **306**, which is identified as the inertial guidance level. Level **306** broadly represents autonomous flight control functionality with operator inserted path commands such as, but not limited to, waypoint editing, loiter point editing or real-time route editing. For illustrative purposes, take-off/landing control **308** and path control **310** have been included on level **306** (it is assumed that both are autonomous to some extent but require operator path input). To simplify the diagram, only a few relevant modes and functions are noted in the Figure specifically.

[0074] As is demonstrated on level **306**, some sub-components or functions can be configured to work in cooperation with others. For example, take-off and landing components may utilize waypoint component functionality in generation of a flight approach for landing purposes. Such functional interdependence is within the scope of the present invention. Further, it should be noted that FIG. 3 is similar to FIG. 1 in that it is simply intended to demonstrate a hierarchical organization scheme in accordance with one aspect of the present invention. Actual characterization of the different functional components is open to interpretation.

[0075] In accordance with one aspect of the present invention, box **312** represents a specific level **306** autonomous mode of control that is worth previewing as an example. Box **312** represents a line-of-sight slave control mode of operation wherein a payload sensor is integrated into the guidance loop such that the vehicle is slaved to operator commanded sensor-pointing angles. In one embodiment of this control mode, the operator is generally concerned primarily with pointing the sensor with his/her attention focused on sensor imagery. The sensor commands are then blended into the UAV guidance algorithms and airframe stabilization commands are computed to orient the vehicle optimally in the mission environment. This control mode illustratively provides the foundation for a virtual reality human system interface, such as a head mounted display, and facilitates telepresence (the linking of remote sensors in the real world to the senses of a human operator) of surveillance and reconnaissance.

[0076] The next level of control structure **300** is level **316**, which is identified as the directional control level. Level **316** broadly represents a hybrid level of autonomous flight control including, in accordance with one aspect of the present invention, as is notably depicted as an insert above block **318**, remote directional command (RDC) capability. In accordance with one embodiment of RDC control, an operator can select a preprogrammed vertical profile maneuver (such as max climb or in-route descent) and maintain manual horizontal directional control of the vehicle. The

operator can instantaneously transition to a control mode in which he/she has complete directional control (both vertical and horizontal) of the vehicle without being required to stabilize it rotationally. In accordance with one embodiment, the operator's control stick commands are mapped to directional commands (horizontal turn rate and climb/descent rates) that are then transformed into acceleration and bank angle commands prior to being fed into a stabilization autopilot, which is represented on level **320**.

[0077] In accordance with one embodiment of the present invention, as is represented by box **318**, control commands, regardless of their functional sub-component source, are transformed into acceleration and bank angle commands. These commands are then passed to the next level of the control structure, namely level **320**, which is illustratively identified as the disturbance rejection autopilot level. In accordance with one aspect of the present invention, all levels of control utilize the same autopilot for a given vehicle, which in the illustrated case is a body-rate stabilization component **322**.

[0078] The lowest level of control structure **300** is level **330**, which is illustratively the level wherein actual manipulation of the aircraft's aerodynamic surfaces and thrust control occurs. Control commands after being filtered through autopilot component **322** are executed on level **330**. In accordance with one embodiment, as is illustrated on level **330** as an arrow insert, one mode of control involves direct control of the aviation surfaces. Accordingly, such control commands are effectuated at a level below level **320** and are therefore relatively manual in nature.

[0079] In accordance with one embodiment of the present invention, the control modes and functions above box **318** generally do not require the operator to possess particularly specialized skills in aircraft aviation. On top of these control modes and functions, the UAV flight control computer performs higher frequency inner loop stabilization and command tracking (e.g., boxes **318** and **322**). To the extent that control conflicts arise wherein multiple sub-components or functions generate conflicting control requests, intelligence synthesizer **150** is illustratively configured to resolve such conflicts prior to generation of acceleration and bank angle commands (box **318**).

[0080] In accordance with one aspect of the present invention, the described vehicle control scheme supports transitions between changing control modes and functions. For example, suppose a UAV is flying a set of waypoints and the operator edits the waypoints. A transition must be made from the old waypoints to the new waypoints. In another example, suppose an aircraft flying a set of waypoints is on course to collide with another aircraft. It is within the scope of the present invention that an air collision avoidance sub-component will override the waypoint path and direct the aircraft off of the collision course. In this case, in accordance with one embodiment, the commands generated for level **316** will first correspond to the requested waypoint path, then there will be a transition to a non-collision path, and then there will be a graceful transition back to the waypoint path.

[0081] In accordance with one aspect of the present invention, intelligence synthesizer **150** is customized to support incorporated sub-components and functions and is thereby configured to generate the control commands necessary to transition control between sub-components and/or functions

as necessary (e.g., acceleration and bank angle commands are obtained and executed as necessary for transitions). In accordance with another embodiment, information for resolving functional conflicts is embedded directly into a sub-component or function itself. It is also within the scope of the present invention that transitions be handled from both locations (e.g., some transitions are processed by the intelligence synthesizer and others are addressed directly within the sub-components or functions).

[0082] Generally speaking, **FIG. 3** represents a top-level flow diagram of how the Mission, Coordination and Execution-Level hierarchical control architecture is organized so that external commands can be easily injected in to the autonomous control structure. The highest-level commands issued by the mission-level functions can be overridden or blended with trajectory edits inserted by a human operator, for example, via a ground control station interface. These commands are sent down to the inertial path regulation control loops, which generate airframe acceleration commands (or flight-path equivalent). If the user injects joystick steering commands, they are translated to the equivalent body acceleration commands, which are gracefully blended into the command chain by the VACS software. The acceleration commands are translated to bank angle and normal acceleration commands, which are articulated by the acceleration tracking and rate stabilization loops. The VACS architecture also provides an insertion point for low-level commands (e.g., stick-and-rudder commands), which correspond to more traditional inputs for piloted aircraft. These commands are directly input to the servos and override all of the other autonomous commands coming into the system.

[0083] **FIG. 4** is a simplified diagrammatic representation of a control structure **400** in accordance with one aspect of the present invention. Control structure **400** includes a funnel representation **402** that represents a funneling of sub-component control functions into an acceleration control and bank angle command generator **404**. In accordance with one embodiment, the information transferred to component **404** incorporates as necessary resolutions for functional conflicts and transitions between control modes or functions.

[0084] Information received by component **404** is transformed into corresponding acceleration and bank angle commands. These commands are then transferred to autopilot component **406**, which in accordance with one embodiment, is configured to make control adjustments as necessary to maintain vehicle stabilization and/or track control commands. Accordingly, all levels of control are filtered through the same autopilot for a given vehicle. In accordance with one embodiment, autopilot component **406** is configured to make adjustments as necessary to maintain stability across control modes. The autopilot functionality is generally fixed and generally does not change regardless of mode selections or changes (e.g., all commands are funneled through the same autopilot). A mode change does not require the autopilot to be reset. Accordingly, the present invention provides continuity at the autopilot level, which is excellent for mode transition. This is an advantage over known systems wherein mode changes are known to cause instability, such as systems that incorporate a different autopilot for different modes.

[0085] As will be discussed in greater detail below, the control system and architecture embodiments of the present

invention essentially enable any autopilot design to support control of a vehicle in numerous control modes that are executed with switches between modes during flight. All control modes are supported even in the presence of sensor errors, such as accelerometer and gyro biases. This robustness is at least partially attributable to the fact that the closed-loop system, in all control modes, is essentially slaved to an inertial path and, hence, the sensor biases wash out in the closed loop, assuming the biases are not so grossly large that they induce stability problems in the autopilot system. Furthermore, winds are generally not an issue in the overall control scheme in that the flight control system will regulate to the inertial path, adjusting for winds automatically in the closed loop. Given the precision afforded by inertial navigation aided by GPS technology, inertial path regulation offers a highly effective and robust UAV control approach. Generally speaking, the autopilot system functions such that winds, medium Dryden turbulence levels, sensor errors, airframe aerodynamic and mass model parameter uncertainties, servo non-linearity (slew rate limits, etc.), and various other atmospheric and noise disturbances will not have a critically negative impact on flight path regulation.

[0086] Component **408** receives commands generated by component **404** and filtered by autopilot component **406**. The commands received by component **408** are executed to actually manipulate the vehicle's control surfaces. Autopilot component **406** then continues to monitor vehicle stabilization and/or command tracking, making additional commands to component **408** as necessary.

[0087] Generally speaking, relative to the control structures illustrated in **FIGS. 3 and 4**, known control systems are inflexible. For example, some known systems support little or no control functionality beyond remote stick-and-rudder commands (e.g., direct control of vehicle control surfaces with little or no incorporated automation). To the extent that a known system offers multiple modes of vehicle control, the modes are typically rigid in nature rather than flexible.

[0088] In accordance with one aspect of the present invention, an entire hierarchical spectrum of multi-autonomous control modes are made available to a system operator. The operator is illustratively able to efficiently and smoothly change control modes mid-mission as desired. The operator can do much more than simply change, edit or adjust waypoints on a waypoint-following mission. An operator can interrupt a waypoint-following mission to guide the vehicle manually, or partially manually (e.g., remote directional commands), or based on sensor/remote line-of-sight command control. In accordance with one embodiment, the control system is configured to optionally transition back to an interrupted mission (e.g., back to an original waypoint-following mission). It should be noted that the "operator" is not necessarily human. For example, the operator could be an automated decision-making source, such as a military C4I system.

[0089] The spectrum of control modes available to an operator illustratively corresponds to the particular functional sub-components incorporated into the variable autonomy control system architecture (e.g., architecture **100** in **FIG. 1**). In accordance with one aspect of the present invention, in addition to numerous specific control modes

that will be described within the present description, a spectrum of additional control modes are conceivable. The control systems of the present invention can be easily configured to support (including conflict and transition support that enables the operator to switch back and forth between modes) basically any control mode or module. Examples of such control modes include:

[0090] 1. Operator inputs a planned route and then the control system autonomously chooses a vehicle (e.g., one of several available vehicles) and automatically guides the vehicle along the planned route . . . or operator designates a moving ground target and then the control system autonomously chooses a vehicle and automatically guides the vehicle to track the ground target

[0091] 2. Operator provides a planned route for a specific vehicle before the vehicle is launched . . . the vehicle follows the pre-planned route

[0092] 3. Same as #2 but operator is allowed to change to a different planned route post launch (e.g., ability to change missions)

[0093] 4. Control based on a vector-based decision process (e.g., vehicle will head in a predetermined direction at speed x, altitude y, etc. . . . then turn based on new vector input information

[0094] 5. Remote Directional Control (RDC) control (e.g., flying directionally such as with a multi-directional joystick input mechanism . . . with autonomous safety nets that do not let the operator aerodynamically stall, over-steer, overbank, or otherwise compromise flight of the vehicle)

[0095] 6. Full Manual Control (remote commands which directly reach the control surfaces un-compensated or conditioned)

[0096] Accordingly, the control systems of the present invention enable an operator to move in and out of a range of different control modes selected from a broad control spectrum including everything from automated mission planning to direct control, with many available modes in between. Modes other than the six listed above are certainly within the scope of the present invention.

[0097] In accordance with one embodiment, the control system architecture of the present invention is flexible enough to support implementation of commercial-off-the-shelf (COTS) components to enable additional system sub-components and corresponding control functionality. For example, software products for automatic route planning are commercially available and can be implemented in the context of the described control system and architecture. For example, OR Concepts Applied (ORCA) of Whittier, Calif. provides at least one software product for route planning such as their "ORCA Planning & Utility System" (OPUS). This is but one example of a software component that can be utilized to extend the functionality of the broader control system. In accordance with one embodiment, while programs such as OPUS are configured to generate a route plan, the configuration of the control structure of the present invention (described in relation to **FIGS. 3 and 4**) will ensure that a generated plan is optimized for the relevant vehicle (e.g., the plan is filtered through command generator **404** and autopilot **406** before vehicle control is directly impacted).



[0098] It should be noted that while FIG. 3 shows manual commands being entered below the autopilot component 322, this is not necessarily the case. With reference to FIG. 4, in accordance with one embodiment of the present invention, when an operator chooses a manual control mode, manual instructions are translated into corresponding acceleration commands. In accordance with one embodiment, the trajectory commands are processed by the autopilot component 406 such that, for example, when the operator lets go of the stick the vehicle will continue on a relatively straight and balanced path.

[0099] The present description, including FIGS. 3 and 4, has been described in the context of a system that incorporates an autopilot component configured to operate in accordance with commands expressed as acceleration-based descriptors of motion. It should be noted that any other commands and corresponding autopilot system can be utilized without departing from the scope of the present invention. For example, component 404 (FIG. 4) can be configured to generate commands in the form of bank-to-turn thrust values, skid-to-turn values, velocity-based values, or any other descriptor of motion. Accordingly, autopilot component 406 is generally a modular component that can be configured to support any of a wide variety of directional command structures and descriptors of motion. Examples of autopilot systems within the scope of the present invention include, but are not limited to, bank-to-turn autopilots, skid-to-turn autopilots, and the like.

[0100] Accordingly, the present invention provides a hierarchical control system and architecture that incorporates a broad range of user-selectable control modes representing variable levels of autonomy. A unified autopilot is provided to process available modes and mode transitions. An intelligence synthesizer is illustratively provided to assist in resolving functional conflicts and transitioning between control modes, although certain resolutions and transitions can be incorporated directly into the functional sub-components associated with the different control modes and functions. In accordance with one embodiment, all modes and transitions are funneled through an acceleration-based autopilot system. Accordingly, control commands and transitions are generally reduced to an acceleration vector to be processed by the centralized autopilot system.

[0101] In accordance with one aspect of the present invention, a translation layer is included to enable specialized control support for a given set of autopilot and vehicle control systems. In other words, the translation layer receives acceleration vectors (or some other output) and translates them into control instructions that are acceptable for a particular vehicle's autopilot and control system. The translation layer essentially enables the control architecture and structures of the present invention to be adapted for any vehicle's autopilot system. For example, in accordance with one embodiment, a vehicle that incorporates a control system that includes flight path angle-based trajectory control can be enhanced with the significant variable autonomy control features of the present invention. The translation layer is configured to receive an input and translate it into whatever commands are necessary to support a given vehicle. It should also be noted it is not required that the translation layer input be in the form of an acceleration vector (e.g., it could be a velocity representation, etc.).

[0102] FIG. 5 is a diagrammatic block representation of a translation layer embodiment of the present invention. As is indicated by block 502, acceleration vectors are passed to a

translator 504. Translator 504 translates the acceleration vectors into a format appropriate for a given autopilot system 506. As is indicated by block 508, the translated control instructions are utilized for vehicle control. Without departing from the scope of the present invention, the software support for the translation layer can be implemented in association with a ground station system and/or an on-board vehicle control system.

[0103] In accordance with one embodiment, through implementation of a translation layer, the control systems of the present invention employ a generalized high-bandwidth autopilot interface design that can be applied to a variety of air vehicles from conventional statically stable tail control airframes to high performance, statically unstable, tail-less combat vehicles or neutrally stable cruise missiles.

#### [0104] IV. System Architecture

[0105] In accordance with one aspect of the present invention, the described VACS architecture and associated hierarchical control structure are implemented in the context of two basic facilitating interface components: a ground control station interface and an airborne system interface. FIG. 6 is a schematic representation of top-level hardware and software objects associated with each interface (labeled interface 602 and 604, respectively). Interfaces 602 and 604 are linked to one another by a datalink 605. Datalink 605 is illustratively a communications link that enables remote communication between the ground station interface and the vehicle interface. All known methods for implementing such a datalink are within the scope of the present invention.

[0106] The ground system interface 602 includes a centralized command and control component 606. Component 606 is illustratively configured to provide an operator with a user control interface. Through the interface, with the aid of a video display component 614, component 606 provides the operator with image data that is received by a mission sensor that is part of the vehicle's on-board payload. Through the interface, with the aid of a vehicle status display 616, component 606 provides the operator with control settings, warnings or other relevant vehicle status information. Through the user interface, with the aid of a map display 610, component 606 provides the operator with a real time map display that shows a vehicle's location relative to a map. A mission evaluation component 612 performs mission analysis and influences command and control component 606 as necessary depending on a given implementation. External interface 618 provides a means for communication with external sources such as, but not limited to, maintenance training equipment that provides logistics support for any of a wide variety of maintenance training equipment. Component 606 is illustratively configured to receive and respond to inputs received from the operator through control input devices 608. Component 606 communicates through datalink 605 with an executive component 652 associated with airborne system interface 604. In this way, the operator is able to control the vehicle at least with regard to flight characteristics and payload operations. Also, component 606 receives data from executive component 652 as necessary to support various system functionalities (e.g., component 606 receives navigation data from component 652 for any of a wide variety of functions, for example, for supplying an indication of aircraft location relative to map display 610).

[0107] The executive component 652 is configured at least to process commands and information received from command and control component 606. Several components are

configured to support the functionality of executive component 652, particularly with regard to flight control and management. An atmosphere component 656 processes characteristics of the vehicle's surroundings as necessary at least to support the execution of manual and automated flight control decisions. A guidance component 658 processes operator inputs, as well as automated and data inputs, in order to facilitate flight control of the aircraft. A navigation component 662 facilitates the collection and provision of data pertaining to aircraft location. Autopilot component 654 receives flight control commands, processes the commands (e.g., makes adjustments to ensure stable flight patterns), and passes commands to actuator control component 668 and engine control component 666 as necessary for flight control execution. Vehicle management component 660 could have any of a variety of functions but illustratively at least coordinates and organizes flight control sensor inputs. Payload control component 664 manages the vehicle payload and facilitates the execution of payload commands received from the operator.

[0108] FIG. 7 is a schematic diagram illustrating an interface system similar to that illustrated in FIG. 6 but adapted for multiple vehicles. Ground system interface 702 is illustratively the same or similar to interface 602 shown in FIG. 6. In order to simplify the illustration of interface 702, only components 606, 608, 610, 614 and 616 are included. Any of the other components of interface 602 could be included without departing from the scope of the present invention. Other or different components could be included without departing from the scope of the present invention.

[0109] Ground system interface 702 includes one component that interface 602 did not. Interface 702 includes a synthetic visuals component that is configured to provide the operator with a relatively real-time display of a synthetically generated depiction of the vehicle and/or its environment. The concept of synthetic visual display represents an embodiment of the present invention and will be described in greater detail below.

[0110] With further reference to FIG. 7, in accordance with one aspect of the present invention, communication between ground system interface 702 and an airborne system interface 730 is through a communications interface 710 (e.g., a SLIP router) (in place of the simplified "datalink" illustrated in FIG. 6). Router 710 works in conjunction with a radio 712 to transfer commands and flight information in a distributed manner to a plurality of radios 714-718. Each radio 714-718 is associated with a different executive component (e.g., components 720-724) located on board a separate vehicle. Each vehicle's executive component is illustratively configured in a manner that is the same or similar to component 652 illustrated in FIG. 6. As is shown in FIG. 7, each executive component 720-724 includes components 652, 666, 668, 664, 662, 654 and 658. Other or different components could be included without departing from the scope of the present invention.

[0111] V. Dynamic Control Schemes

[0112] FIG. 8, in accordance with one aspect of the present invention, is a schematic diagram representing a vehicle control scheme that supports implementation in the context of the described VACS architecture and control structure. It should be emphasized that any form of autopilot controller (e.g., classical, optimal, robust, non-linear, or adaptive) can be employed without departing from the scope of the present invention, and without affecting the system architecture or operator control policies.

[0113] In accordance with the illustrated control scheme, operator inputs 802 are provided to vehicle management software 804. Management software 804 is configured to support an illustrative three different classes of control and corresponding operator inputs. The first class is represented by block 806, which is labeled energy optimal trajectory. Control modes of this type involve controlling the vehicle in a substantially automated manner so as to maintain a preferred or designated trajectory while expending a relatively minimized amount of energy (e.g., to conserve potential energy). The second class is represented by block 808, which is labeled autonomous path control. Control modes of this type involve controlling the vehicle in a substantially automated manner so as to maintain a flight control path that is mission oriented and, optionally, selected and/or modified by the operator. The third class is represented by block 810, which is labeled line-of-sight slave commands. As has been described, control modes of this type generally involve controlling the vehicle based primarily on manipulation of a visual sensor. The third class is represented by block 812, which is labeled remote directional commands. Control modes of this type have been previously described herein and generally involve, in one embodiment, controlling the vehicle based on simplified directional commands with reliance on automation to determine appropriate execution parameters.

[0114] A switch 814 represents a selection of one of the different control classes based, for example, on a control mode selection that corresponds to an operator input 802. The switch 814 is notionally represented by a simple switch but is illustratively embedded in the more complex Intelligence Synthesizer processing architecture. Once a connection with a control class/mode has been established, subsequent corresponding vehicle control commands are translated through bank-to-turn and thrust control component 816 (e.g., corresponding acceleration vector commands are generated). Additional data derived from an air-data sensor source 818 and/or software 804 is fed into the control process as necessary. The output of control component 816 is adjusted at component 820 (e.g., autopilot adjustments) in order to compensate for deviations from the original control command. As is illustrated, information from commercial-off-the-shelf integrated components 822 (e.g., coordinate information from GPS/IMU/NAV systems) can be fed into the determination of actual deviations as necessary, and can also be utilized by software 804 for any purpose such as but not limited to route planning. Following adjustments for deviations, box 824 represents adjustments for airframe stabilization (e.g., autopilot adjustments).

[0115] Following the steps associated with boxes 816, 820 and 824, box 826 represents the step wherein control commands are actually executed and vehicle control surfaces and engine dynamics are actually manipulated based on the commands. Following execution of the commands, sensors associated with air-data sensor 818 and integrated components 822 return data to points upstream in the process such that additional adjustments can be made if necessary (e.g., necessary to keep the vehicle on track with a desired route or necessary to keep the vehicle from stalling, crashing, etc.). As is indicated at 830, inertial dynamics are processed following command execution. This information is passed along to camera stabilization and pointing component 840 such that adjustments can be made if necessary to stabilize a camera, such as a gimbal-mounted camera utilized to support line-of-sight slave commands 810. Adjustments can be made to the camera configuration based on relative geometry in order to keep the camera relatively stable.

Information input **832** represents an input of target location information that enables the camera to focus on and follow a target.

[**0116**] There are several features and extensions of the described control approach to highlight:

[**0117**] 1. In accordance with one aspect of the present invention, a library of robust mathematical guidance algorithms (examples of which are described later in the present description as embodiments of the present invention) are employed to accommodate remote operator command insertion at every level of flight control to address not just the flight control problem but also flight management. This design approach provides simplified manual control modes that enable a relatively unskilled operator with minimal training to control the vehicle.

[**0118**] 2. In accordance with another aspect of the present invention, the payload sensor control is integrated into the guidance loop to provide a control mechanism that shifts the operator's focus from vehicle control to sensor control, without concern of the vehicle flight profile. This control mechanism also facilitates the introduction of a virtual control interface bringing immersive control techniques to the airborne surveillance and reconnaissance arena.

[**0119**] 3. An intuitive human-system interface (described in other sections below) offers an interface with which operators can be trained to execute a successful vehicle mission in a matter of hours or days as opposed to weeks, months, or years.

[**0120**] 4. An intuitive, real-time mission planning capability is built into the ground control station software to support real-time route editing and vehicle mission retasking.

[**0121**] 5. The system enables real-time mission assessment such that the operator can make rapid and precise real-time mission updates, as dictated by higher level operational needs that change continuously within a dynamic environment (e.g., battle environment).

[**0122**] In accordance with one aspect of the present invention, to enable a simplified manual control concept, the controller structure is implemented such that the operator can have direct control of three outer-loop states: airspeed ( $u$ ), turn rate ( $\psi$ ) and altitude rate ( $h$ ). To satisfy the requirements of fully autonomous flight, it is generally desired to close the outer loop around a fixed path that is defined by preprogrammed waypoints. Analysis of the problem shows that both requirements (simplified manual and fully autonomous control) could be satisfied with a single control loop structure.

[**0123**] In accordance with one aspect of the present invention, an improved control loop structure is provided. **FIG. 9** is a control diagram representing a general integrated guidance loop structure. Box **902** represents operator input and box **904** represents gain or mapping from input to autopilot. Together, boxes **902** and **904** represent an operator command insertion point, for example for the simplified manual control mode herein referred to as Remote Directional Response (RDR) or Remote Directional Command (RDC). Box **910** represents a waypoint guidance input. Box **912** represents pre-filtering adjustment to input **910** to maintain a properly conditioned signal with desirable steady-state properties. Box **914** represents a gain adjustment to input **910** to compensate for command error. Box **916** represents a feedback loop providing an adjustment for phugoid damp-

ening. Box **918** represents autopilot controller functionality. Box **920** represents the airframe plant itself (e.g., the vehicle and associated actuators actuated in response to the control input). Finally, box **922** represents integrals of the first dynamic states, thus completing the plant dynamics model.

[**0124**] A switch **906** is inserted between the autopilot **908** and guidance system thereby enabling the operator to command the autopilot **908** directly. The switch **906** is notionally represented by a simple switch but is illustratively embedded in the more complex Intelligence Synthesizer processing architecture. An example of operator commanded autopilot control is horizontal steering. For horizontal steering, the operator's control stick commands are mapped to horizontal turn rate commands. The guidance software illustratively gains the turn rate command by the current vehicle inertial velocity and feeds this term to the autopilot. In the vertical channel, the operator control stick commands are mapped to an altitude rate. The guidance software converts this command into a flight path angle command and computes a flight path following acceleration command that feeds the autopilot. In accordance with one embodiment, when the operator "lets go of the stick", the flight software simply commands the vehicle to fly straight and level at the current altitude and current heading.

[**0125**] As **FIG. 9** demonstrates, the general form of the outer loop guidance algorithm is a second order inertial path controller. The corresponding form of the autopilot utilizes an acceleration command input. Thus, the incorporated autopilot structure is an acceleration command autopilot in the pitch and yaw axis and a bank angle command autopilot in the roll axis. It should be noted that other gain scheduling techniques and acceleration autopilots are within the scope of the present invention. Different autonomous vehicles will illustratively incorporate different gain scheduling techniques and autopilots, the VACS architecture and control structures being conveniently adaptable by one skilled in the art to accommodate such variations. A list of autopilot systems that can be accommodated includes, but is not limited to:

[**0126**] 1. Linear classical control designs using pole-placement gain scheduling techniques

[**0127**] 2. Non-linear control design using dynamic inversion

[**0128**] 3. Non-linear adaptive control design

[**0129**] 4. LQR (optimal) control design

[**0130**] 5. Loop shaping control design

[**0131**] In one embodiment, as was alluded to in relation to **FIG. 5**, a translation layer can be implemented to translate a given control output (e.g., an acceleration based command) to an alternative form as necessary to accommodate any of the above five or other autopilot systems.

[**0132**] VI. Coordinate Frame Definitions

[**0133**] In order to support description of specific control modes and guidance methods, a few different standard coordinate frame definitions and transformations will now be described.

[**0134**] **FIG. 10-1** is a diagrammatic representation of an Earth Centered Earth Fixed (ECEF) coordinate frame definition. The ECEF reference frame is oriented with its origin at the earth's center. The x and y axes lie in the equatorial

plane with the x-axis passing through the Greenwich Meridian. The z-axis is normal to the x-y plane and passes through the North Pole.

[0135] FIGS. 10-2 and 10-3 are diagrammatic representations of a Geodetic coordinate frame definition. The geodetic coordinate frame defines the lines of latitude and longitude along the earth's surface. Geodetic latitude is the angle between the equatorial plane and the normal to the surface of the ellipsoid. Geodetic longitude is the angular rotation relative to the ECEF x-axis in the equatorial plane. Geodetic altitude is the elevation above the ellipsoid surface.

$$T_E^L = \begin{bmatrix} -\sin(\lambda)\cos(l) & -\sin(\lambda)\sin(l) & \cos(\lambda) \\ -\sin(l) & \cos(l) & 0 \\ -\cos(\lambda)\cos(l) & -\cos(\lambda)\sin(l) & -\sin(\lambda) \end{bmatrix} \quad \text{Eq. 2}$$

[0140] Local vertical guidance commands can then be transformed into the body reference frame for input to the autopilot through the transformation matrix (pitch angle  $\Theta$ , yaw angle  $\Psi$ , roll angle  $\Phi$ ):

$$T_B^L = \begin{bmatrix} \cos\Psi\cos\Theta & \sin\Psi\cos\Theta & -\sin\Theta \\ \cos\Psi\sin\Theta\sin\Phi - \sin\Psi\cos\Phi & \sin\Psi\sin\Theta\sin\Phi + \cos\Psi\cos\Phi & \cos\Theta\sin\Phi \\ \cos\Psi\sin\Theta\cos\Phi + \sin\Psi\sin\Phi & \sin\Psi\sin\Theta\cos\Phi - \cos\Psi\sin\Phi & \cos\Theta\cos\Phi \end{bmatrix} \quad \text{Eq. 3}$$

[0136] A coordinate reference frame definition that is not illustrated is the local vertical reference frame, which is oriented with its origin at a point along the earth's surface defined by an angular rotation from the ECEF frame (latitude and longitude) and an altitude, h, above the earth's surface. This frame's z-axis is normal to the local tangent of the ellipsoid. The x-y plane lies normal to the z-axis and parallel to the local horizon.

[0137] FIG. 10-4 is a schematic representation of a body reference frame. The body reference frame has its origin at the vehicle center of gravity. The y-axis extends out of the right wing of the vehicle, the x-axis extends out the nose of the vehicle, and the z-axis is positive down passing normal to the x-y plane.

[0138] Certain embodiments of the present invention involve coordinate frame transformations. For example, a function can be applied to transform geodetic coordinates to ECEF coordinates. In accordance with one embodiment of such a transformation, coordinate waypoints are passed into the UAV flight computer in geodetic coordinates (latitude ( $\lambda$ ), longitude ( $l$ ), and altitude ( $h$ ), Earth semi-major axis ( $a_E$ ), eccentricity  $e$ ). These waypoint locations are then transformed to ECEF coordinates utilizing a function such as:

$$P_{ECEF} = \begin{Bmatrix} \left( \frac{a_E}{\sqrt{1 - e^2 \sin^2(\lambda)}} + h \right) \cos(\lambda) \cos(l) \\ \left( \frac{a_E}{\sqrt{1 - e^2 \sin^2(\lambda)}} + h \right) \cos(\lambda) \sin(l) \\ \left( \frac{a_E(1 - e^2)}{\sqrt{1 - e^2 \sin^2(\lambda)}} + h \right) \sin(\lambda) \end{Bmatrix} \quad \text{Eq. 1}$$

[0139] Similarly, ECEF coordinates can be transformed into local vertical coordinates. In accordance with one embodiment of such a transformation, the guidance error equations are formulated in the ECEF reference frame, then converted to the local vertical reference frame for computation of the guidance commands. The ECEF to local vertical transformation matrix can be defined as:

[0141] VII. Navigator

[0142] In another aspect of the present invention, vehicle state information is provided by a component herein referred to as the navigator component. Navigator components are known in the art to provide information such as, but not limited to, position, velocity, acceleration, angular position and/or angular velocity associated with the vehicle. Some known navigator components incorporate sensor devices such as, but not limited to, a three-axis inertial measurement unit, a GPS receiver, and/or strap-down equation software, and Kalman filter used to estimate the IMU sensor error.

[0143] Information output from navigator components is utilized for any of a variety of purposes. For example, the accelerations, angular rates and other similar outputs are illustratively fed into an autopilot system in support of stability-enhancing processes. Position, velocity, angular position and other similar outputs are used by the guidance functionality to aid in decision-making such as, but certainly not limited to, path-regulation.

[0144] VIII. Guidance

[0145] In another aspect of the present invention, a guidance function is responsible for generating autopilot commands that, when executed, achieve a particular guidance objective. Guidance objectives are designed to satisfy operator interface and mission control requirements and include functions such as, "regulate to a preprogrammed inertial path," "go to and monitor a specified target coordinate," "execute an operator commanded programmed maneuver," "slave to an operator commanded sensor stare command," etc.

[0146] FIG. 11, in accordance with one aspect of the present invention, is a schematic block diagram demonstrating a basic flow structure for the various flight mode levels and identifying underlying guidance laws called by the flight management software component. There are an illustrative four levels of operational modes within the vehicle manager: flight mode 1102, flight sub-mode 1104, guidance mode 1106, and guidance sub-mode 1108.

[0147] Flight mode 1102 includes three different functions, namely, take-off 1110, inflight 1112, and landing 1114. For take-off 1110, flight sub-mode 1104 includes four primary functions, namely, taxi 1116, throttle-up 1118, ground

roll 1120 and climbout 1122. When these four sub-mode functions have been executed, guidance mode 1124 (fly waypoints) is executed. In that regard, waypoint guidance law 1134 is executed including sub-modes 1126 (waypoint capture) and 1128 (leg regulation).

[0148] When the flight mode is inflight 1112, the operator can select between flight sub-modes 1136 (autonomous control) and 1140 (manual control). One selectable option for autonomous control is the fly waypoints 1124 guidance mode in accordance with waypoint guidance law 1134. Another selectable autonomous control mode is loiter guidance mode 1142, which is executed in accordance with loiter capture guidance sub-mode 1130 and orbit guidance sub-mode 1132 being subcomponents of loiter guidance law 1144.

[0149] Options for manual control 1140 include RDC guidance mode 1146, LOS-slave mode 1148 and hybrid control mode 1150. Each of these manual control modes are related to guidance sub-modes 1152 (command following) and 1154 (reference hold), which are related to flight path guidance law 1156. It should be noted that guidance modes and guidance sub-modes can be combined as indicated to enable a biased pursuit guidance law 1158 in accordance with one aspect of the present invention.

[0150] The library of outer-loop guidance modes support both autonomous control as well as simplified manual control. Guidance laws that are within the scope of the present invention and are exploited by the vehicle manager include, but are not limited to, waypoint guidance, loiter guidance, line-of-sight slave control guidance and remote directional command guidance. Various guidance modes invoke these guidance laws to achieve diverse mission objectives. For example, loiter guidance is a guidance law invoked by several difference guidance modes including, but not limited to, programmed route guidance, park guidance, observation point guidance, and moving target tracking guidance.

[0151] In one embodiment, the operator at any point during a mission can interrupt the vehicle management software component. The component will illustratively process the operator's inputs and perform the appropriate action, which may include entering a manual control mode, entering an operator specified orbit pattern, or updating and executing a planned navigation route.

[0152] The control system design and architecture of the present invention enables a single operator to seamlessly transition between varying levels of control autonomy for an individual vehicle. Such control capability even enables the single operator to effectively manage and control a team of vehicles. In another aspect of the present invention, to support such functionality, a gradient control scheme is provided and utilizes on-board trajectory synthesis techniques to establish an inertial reference trajectory to which a vehicle is regulated. The gradient control approach is predicated on the use of acceleration feedback in the pitch channel autopilot. As has been alluded to, however, the solution is extensible to platforms that do not employ acceleration feedback, for example through implementation of a mathematical translation or transformation from the acceleration command to the native state command accepted by the native autopilot. Hence, an acceleration autopilot is not implicitly required to adequately satisfy the guidance

objectives generated by the presently described variable autonomy control algorithms.

[0153] Kinematics provides a motivation for acceleration based vehicle control. Both rectilinear and relative general plane equations of motion relate position and velocity states (translational or angular) to acceleration through mathematically tractable differential equations. The following equations are examples of translational and rotational differential equations formulated as guidance laws for typical navigation and homing guidance:

$$\vec{a}_{cmd} = \omega^2 \Delta \vec{P} + 2\zeta\omega \Delta \dot{\vec{P}} + \vec{g} \tag{Eq. 4}$$

- [0154] where
- [0155]  $\omega$ =guidance law natural frequency
- [0156]  $\Delta \vec{P}$ =guidance position error
- [0157]  $\zeta$ =guidance law damping ratio
- [0158]  $\Delta \dot{\vec{P}}$ =guidance velocity error
- [0159]  $\vec{g}$ =gravity
- [0160] (translational—waypoint guidance)

$$R\ddot{\lambda} - 2V\dot{\lambda} = -NV\dot{\lambda} = -a_{cmd} \tag{Eq. 5}$$

- [0161] where
- [0162] R=relative range to target
- [0163]  $\lambda$ =line-of-sight acceleration
- [0164] V=closing velocity to target
- [0165]  $\dot{\lambda}$ =line-of-sight rate
- [0166] N=guidance law gain
- [0167] (rotational—proportional navigation)

[0168] Such equations are consistent with fundamental principals of autonomous vehicle guidance and control. The theory behind the autonomy control systems of the present invention illustratively capitalizes on the properties of the differential equations that formulate the desired acceleration commands. Given that the underlying equations of motion that describe physical motion of air vehicles are continuous functions operating over a set of real variables from “negative infinity to positive infinity” (no discontinuities in the function), then it serves that the derivatives of these functions are continuous. Hence, rectilinear acceleration commands can be generated to regulate velocity reference trajectories (first order control law—acceleration is the first derivative of velocity) or position reference trajectories (second order control law—acceleration is the second derivative of position). It can therefore be shown that the transition between derivative control modes is stable, assuming the gains for each corresponding control scheme provide a stable response. Closed-loop stability over mode transitions is then eliminated as a concern and, hence, the transition between control modes is essentially seamless. The following equations illustrate this principal:

Gradient Control Scheme: Eq. 6

$R$  = Input (state to be controlled)  
 $U$  = Control signal  
 $U = \frac{\partial^n R}{\partial t^n}$ ,  $n$  is number of derivatives between input and control signal

Example Applications Eqs. 7 & 8

CASE 1: SECOND – ORDER

$R$  = Reference path for waypoint guidance ( $P$ )  
 $U$  = Acceleration command( $a$ )  
 $a = \frac{\partial^2 P}{\partial t^2} \stackrel{\text{Laplace}}{=} (As^2 + Bs + C)P(s) = 0 \implies \delta \ddot{P} = a = 2\zeta\omega\delta\dot{P} + \omega^2\delta P$

CASE 2: FIRST – ORDER

$R$  = Flight path velocity command  $\left(\gamma \approx \frac{V_{up}}{|V|}\right)$   
 $U$  = Acceleration command( $a$ )  
 $a = \frac{|V|\partial\gamma}{\partial t} \stackrel{\text{Laplace}}{=} |V|(As + B)\gamma(s) = 0 \implies |V|\dot{\lambda} = a = \frac{|V|}{\tau}\delta\gamma$

[0169] The above examples illustrate waypoint guidance (second order) and flight path angle guidance (first order) laws. The guidance laws can regulate to any mathematically tractable reference path from which position and/or velocity and orientation errors between the vehicle and the path are computed. The reference paths can be generated apriori by a mission planner (waypoint route, for example) or synthesized autonomously by on-board flight control software to achieve a high level objective commanded by an operator (autonomous landing terminal trajectory, for example). This approach provides a control scheme in which an operator can issue commands of varying levels of autonomy without regard for the closed-loop vehicle stability during mode transitions. Applying this scheme, in accordance with one embodiment of the present invention, a baseline set of guidance laws alluded to in FIG. 8 (waypoint guidance, flight path angle guidance, line-of-sight rate guidance, and sensor-slave guidance) provide a core guidance law toolbox upon which the variable autonomy control system described herein is built. Higher level software processing functions then interpret operator commands, sensor inputs, and database inputs and translate these inputs into executable guidance laws that the control system then acts on. In another aspect of the present invention, this design enables robust higher level autonomous control functions within the described VACS framework. Such functions illustratively include, but are not limited to, functions for ground collision avoidance, air collision avoidance (“see & avoid”), ground moving target tracking and following, formation flying (multiple vehicles), and autonomous landing. Autonomous guidance algorithms designed to support the system will now be described in greater detail.

[0170] A. Waypoint Guidance

[0171] In accordance with one aspect, as is indicated by block 132 in FIG. 1, one provided control mode enables a

waypoint guidance control mode. In one embodiment of waypoint guidance, guidance error computations are performed in the ECEF reference frame then rotated into the local vertical reference frame prior to being addressed in the guidance law. The error computations are illustratively separated between a waypoint leg regulation phase and a waypoint leg transition phase. While inertially guiding to a waypoint leg, the guidance errors are illustratively derived by first forming a vector triangle between the vehicle (i.e., the UAV) and the two waypoints that make up the waypoint leg.

[0172] FIG. 12 is a schematic diagram demonstrating waypoint guidance error calculation in accordance with one embodiment of the present invention. The position error ( $\Delta \vec{P}$ ) and the velocity error ( $\Delta \vec{V}$ ) can be computed from the vector triangle shown in the Figure. For example,

$$\begin{aligned} \vec{B} &= \vec{P}^{UAV} - \vec{P}^{WP1} & \text{Eq. 9} \\ \vec{R}_{LEG} &= \vec{P}^{WP2} - \vec{P}^{WP1} \\ \vec{u}_{LEG} &= \frac{\vec{R}_{LEG}}{|\vec{R}_{LEG}|} \\ \Delta \vec{P} &= \vec{B} - (\vec{B} \cdot \vec{u}_{LEG})\vec{u}_{LEG} \\ \Delta \vec{P} &= \vec{V}_1 - (\vec{V}_1 \cdot \vec{u}_{LEG})\vec{u}_{LEG} \end{aligned}$$

[0173] These Eq. 9 calculations provide the solution for horizontal channel guidance errors. A correction must be made, however, to the vertical channel guidance error to account for the earth’s curvature.

[0174] FIG. 13 is a schematic diagram demonstrating that considerable altitude errors can be introduced by failing to account for the earth’s curvature. Since the guidance errors are ultimately rotated into the local vertical coordinate frame, a simple solution exists to performing the great circular arc correction. Through recognizing the fact that each waypoint altitude is stored as an ellipsoidal altitude and that the current vehicle ellipsoidal altitude is always available from the navigation solution, the curvature problem can be mathematically eliminated from the altitude error calculation with instantaneous ECEF to local vertical transformation. Simply stated, the altitude error is computed as the error between the current vehicle ellipsoidal altitude and the geodesic line connecting the two waypoints. Although the path is a curved path in the ECEF frame, the instantaneous rotation to the local vertical frame linearizes the problem.

[0175] FIG. 14 is a schematic diagram demonstrating altitude error calculation in the form of a curvature correction for the vertical guidance error. Using the nomenclature in FIG. 14, the local vertical altitude error (accounting for the earth’s curvature) is illustratively computed as:

$$\Delta H = H_V - H_1 - \frac{x}{R_G}(H_2 - H_1) \quad \text{Eq. 10}$$

[0176] The local vertical velocity error is calculated as:

$$\Delta \dot{H} = \dot{H}_V - |\vec{V}_1| \sin(\gamma_{1D})$$

[0177] In accordance with one aspect of the present invention, waypoint leg transition logic is premised on a desire to transition waypoint legs when the horizontal acceleration required to drive the vehicle onto the next waypoint leg heading in the desired waypoint leg direction is a minimum. This requirement is achieved mathematically by transitioning waypoint legs when the dot product of the horizontal position error (relative to the next waypoint leg) and the horizontal acceleration error (relative to the next waypoint leg) is zero. Since it is not guaranteed that this dot product will be identically zero on any given compute cycle, the transition occurs when the sign of this dot product changes from positive to negative.

[0178] FIG. 15 is a schematic diagram demonstrating the waypoint leg transition issue with particular coordinate frames to be utilized in an algorithm designed to address the issue. The waypoint leg transition algorithm begins by computing local vertical guidance errors (position and velocity) and an acceleration command vector relative to the next waypoint leg in the same manner that these errors are computed relative to the current waypoint leg. Next a rotation matrix between the local vertical reference frame (E, N) and the next waypoint leg reference frame (Along, Across) is computed as follows:

$$\begin{Bmatrix} \text{Along} \\ \text{Across} \end{Bmatrix} = \begin{bmatrix} \sin(\Psi_{leg}) & \cos(\Psi_{leg}) \\ \cos(\Psi_{leg}) & -\sin(\Psi_{leg}) \end{bmatrix} \begin{Bmatrix} E \\ N \end{Bmatrix} \quad \text{Eq. 12}$$

[0179] The local vertical to waypoint leg reference frame rotation matrix is illustratively denoted  $T_L^W$ . The position and acceleration errors relative to the next waypoint leg are then rotated into the next waypoint leg reference frame:

$$\begin{aligned} \Delta \vec{P}_w &= T_L^W \Delta \vec{P}_{LV} \\ \Delta \vec{a}_{cw} &= T_L^W \vec{a}_{cLV} \end{aligned} \quad \text{Eq. 13}$$

[0180] The waypoint leg transition illustratively occurs when  $\Delta P_{Across} a_{cAcross} \leq 0$ .

[0181] In accordance with one aspect of the present invention, an enhanced waypoint guidance algorithm is applied to achieve improved path regulation during 3D waypoint turns. Issues arise when two adjoining waypoint segments have different vertical and horizontal slopes, requiring the vehicle to “turn” in both the horizontal and vertical channels. These two waypoint segments form a plane (‘two intersecting lines form a plane’). In accordance with one embodiment, the parameters for this plane are computed and the vehicle is commanded to perform its turn in that plane.

[0182] FIG. 16 is a schematic diagram demonstrating the concept of commanding the vehicle to perform its turn in the derived plane. In accordance with one embodiment, the control law used during the 3D planar turn is:

$$\vec{a}_{cmd} = -\frac{V^2}{R} \vec{U}_{plane} + \omega^2 \Delta \vec{P} + 2\zeta \omega \Delta \vec{V} + g \vec{U}_p \quad \text{Eq. 14}$$

[0183] where

$$\begin{aligned} \Delta \vec{P} &= \vec{R} + P_{turn} \vec{u}_{plane} \\ \Delta \vec{V} &= (\vec{V} \cdot \vec{n}_{plane}) \vec{n}_{plane} + (\vec{V} \cdot \vec{u}_{plane}) \vec{u}_{plane} \end{aligned}$$

[0184]  $R_{turn}$ =Vehicle turn radius

[0185]  $\vec{R}$ =relative distance between vehicle and turn center

[0186] The turn radius is illustratively vehicle dependent and the planar parameters (plane center location, plane normal vector, and plane unit vector) are all illustratively computed using basic analytical geometry. This algorithm is illustratively advantageous at least in that it promotes generality for precision path control across a broad class of UAV’s.

[0187] The waypoint guidance system is illustratively organized as a linked list of events augmented with smooth turn and leg propagation logic at each station. An event is illustratively, but not limited to, a way point, an orbit pattern, a payload command (e.g., point camera at location x) or some other event. This provides the capability to easily edit the mission plan from the graphical display both during pre-flight mission planning and while the UAV is in the air. If the operator discovers an unknown hazard in the pre-planned flight-path, then he can either “drag-and-drop” existing events or he can delete and insert new events as necessary.

[0188] For illustrative purposes only, table 1 is provided as a sample collection of event parameters.

TABLE 1

Event Type	Waypoint, figure 8, racetrack, ellipse (circle is racetrack with equal length and width)
Waypoint latitude	Geodetic latitude of waypoint or orbit pattern center
Waypoint longitude	Geodetic longitude of waypoint or orbit pattern center
Waypoint Altitude	Ellipsoidal altitude of waypoint or orbit pattern center
Waypoint Speed	Speed setting at waypoint location
Orbit pattern length	Length of desired orbit pattern
Orbit pattern width	Width of desired orbit pattern
Orbit pattern orientation	Rotation angle of orbit pattern (relative to true North)
Number of orbit laps	Desired number of orbit laps
Time in orbit	Desired time to maintain orbit pattern (overrides orbit laps if greater than minimum threshold)
Orbit pattern center offset	Offset vector of orbit pattern center from known target location

[0189] B. Loiter Control

[0190] In accordance with one aspect of the present invention, as is indicated by block 134 in FIG. 1, one provided control mode enables an operator to loiter a vehicle over a given station, for example, to monitor a desired surveillance point. 10 The system illustratively enables the operator to either preprogram a set of orbit patterns embedded within a waypoint route or dynamically insert orbit patterns into an existing route in real-time. The operator can illustratively set loiter parameters such as length, width, and orientation (i.e., heading) of the orbit pattern with a simply controlled input operation (e.g., mouse controlled click-and-drag operation on a 2D map displayed as part of the user interface). In accordance with one embodiment, a set of relief or hand-off park modes is also provided in which the vehicle will

automatically enter into a default racetrack, a figure-8, or an elliptical orbit pattern upon command from the operator.

[0191] Accordingly, one embodiment of the present invention pertains to system support for an elliptical orbit pattern. The system illustratively enables the operator to select an oval or a constant radius (circular) loiter pattern. In accordance with one embodiment, along with an operator selectable offset vector for the loiter pattern centroid, the operator is also illustratively provided with the capability to select a loiter pattern “heading” relative to north. For circular patterns this option has little value. For elliptical patterns, however, the latter selection option provides the operator with an ability to adjust a loiter pattern to fit virtually any desired geographic location, such as a country’s border or a canyon.

[0192] In accordance with one aspect of the present invention, loiter guidance is achieved through two basic guidance laws: 1) Biased pursuit guidance law used to drive the vehicle onto a desired loiter pattern (illustratively referred to herein as loiter capture); and 2) Elliptical guidance law which serves as an inertial path controller designed to slave the vehicle to an elliptical loiter pattern (illustratively referred to herein as loiter guidance).

[0193] FIG. 17, in accordance with one aspect of the present invention, is a schematic diagram defining parameters and coordinate frames used to construct the elliptical loiter guidance law. The desired surveillance point and ellipse center offset, semi-major axis, and semi-minor axis are either preprogrammed into the UAV flight software or input by the operator real-time during a mission. Once the UAV captures the desired loiter pattern, the loiter guidance law is invoked. The loiter guidance error equations are computed in the ellipse reference frame. This frame is defined as  $(x_E, y_E)$  in FIG. 17. The transformation matrix from the local vertical reference frame to the ellipse reference frame  $(T_{LV}^E)$  is computed as:

$$\begin{Bmatrix} x_E \\ y_E \\ z_E \end{Bmatrix} = \begin{bmatrix} \cos(\Psi_E) & -\sin(\Psi_E) & 0 \\ \sin(\Psi_E) & \cos(\Psi_E) & 0 \\ 0 & 0 & 1 \end{bmatrix} \begin{Bmatrix} E \\ N \\ U \end{Bmatrix} \quad \text{Eq. 15}$$

[0194] The transformation matrix from the ECEF frame to the ellipse frame is then computed as:

$$T_{ECEF}^E = T_{LV}^E T_{ECEF}^{LV} \quad \text{Eq. 16}$$

[0195] The position of the vehicle is computed relative to the surveillance point in ellipse coordinates as follows:

$$\vec{P}_{rel}^E = T_{ECEF}^E (\vec{P}_{UAV}^{ECEF} - \vec{P}_S^{ECEF}) \quad \text{Eq. 17}$$

[0196] where

[0197]  $\vec{P}_{UAV}^{ECEF}$  = ECEF UAV position

[0198]  $\vec{P}_S^{ECEF}$  = ECEF surveillance point location

[0199] Consistent with basic analytic geometry, the equation for an ellipse can be written in parametric coordinates:

$$x_E = x_c + b \sin(t); y_E = y_c + a \cos(t) \quad \text{Eq. 18}$$

[0200] Utilizing this relationship and assuming that the vehicle is near the desired ellipse, the instantaneous ellipse parametric angle  $(t)$  is computed as

$$t = \tan^{-1} \left( \frac{a(P_{rel_x}^E - x_c)}{b(P_{rel_y}^E - y_c)} \right) \quad \text{Eq. 19}$$

[0201] It is important to emphasize the assumption that the vehicle is near the desired loiter pattern. This is the assumption that drives the requirement of a second guidance law (loiter capture) to guide the vehicle onto the ellipse. In accordance with one embodiment, “Near the ellipse” is quantified in terms of relative heading and horizontal ground distance. The guidance software is configured to consider the vehicle to be near the ellipse if the horizontal ground distance between the vehicle and the ellipse surface is less than a predetermined distance threshold (e.g., 0.1 nm) and the relative heading error between the vehicle and the ellipse tangent is less than a predetermined angular threshold (e.g., 10 deg.).

[0202] Having computed the instantaneous parametric angle, the desired vehicle position is computed using the ellipse parametric equations:

$$\vec{P}_D^E = \begin{Bmatrix} x_c + b \sin(t) \\ y_c + a \cos(t) \\ 0 \end{Bmatrix} \quad \text{Eq. 20}$$

[0203] The desired heading in ellipse coordinates is then computed as:

$$\Psi_D = \tan^{-1} \left( \frac{a^2(P_{D_x}^E - x_c)}{b^2(P_{D_y}^E - y_c)} \right) - \pi \quad \text{Eq. 21}$$

[0204] The associated desired inertial velocity vector is then computed:

$$\vec{V}_D^E = T_{LV}^E \begin{Bmatrix} |\vec{V}_1| \sin(\Psi_D) \\ |\vec{V}_1| \cos(\Psi_D) \\ 0 \end{Bmatrix} \quad \text{Eq. 22}$$

[0205] Note that a constant altitude loiter is illustratively assumed. The guidance position and velocity errors in local vertical coordinates are computed as follows:

$$\Delta \vec{P}^{LV} = [T_{LV}^{E \rightarrow LV}] (\vec{P}_{rel}^E - \vec{P}_D^E) \quad \text{Eq. 23}$$

$$\Delta \vec{V}^{LV} = [T_{LV}^{E \rightarrow LV}] (\vec{V}_1^E - \vec{V}_D^E)$$

[0206] where  $\vec{V}_1^E$  = Inertial velocity vector in ellipse coordinates

[0207] An instantaneous radius of curvature ( $\rho$ ) can be computed at each point along the ellipse. This curvature vector is normal to the ellipse tangent, which defines the heading to which the vehicle will align the inertial velocity vector. Because the vehicle is slaved to the ellipse, the



instantaneous radius of curvature of the ellipse is identically equal to the instantaneous vehicle horizontal turn radius. Hence the ellipse radius of curvature can be used to augment the guidance law, as it will provide the desired steady-state horizontal centripetal acceleration. The radius of curvature is computed as:

$$\rho = \frac{[b^2 \cos^2(t) + a^2 \sin^2(t)]^{\frac{3}{2}}}{ab} \quad \text{Eq. 24}$$

[0208] The desired centripetal acceleration command in local vertical coordinates can then be computed as:

$$\vec{a}_{cent} = [T_{Lv}^E]^T \left( \frac{|\vec{V}_v|}{\rho} \right) \begin{Bmatrix} -\sin(\eta) \\ -\cos(\eta) \\ 0 \end{Bmatrix} \quad \text{Eq. 25}$$

[0209] The local vertical acceleration command vector is computed as:

$$\begin{aligned} \vec{a}_c^{LV} &= \vec{a}_{cent} - k_p \Delta \vec{P}^{LV} - k_v \Delta \vec{V}^{LV} - \vec{g}^{LV} + k_p k_{FFZ,1} \vec{V}_c \\ \vec{V}_c &= [0 \ 0 \ V_c]^T = \text{Airspeed command} \\ [\vec{g}^{LV}] &= [0 \ 0 \ -9.81]^T \end{aligned} \quad \text{Eq. 26}$$

[0210] This acceleration command vector is then processed through a translation layer and/or is delivered to the autopilot system.

[0211] In accordance with one aspect of the present invention, the loiter capture algorithm is designed to drive the vehicle onto the desired loiter pattern from any location outside of the planned pattern. In accordance with one embodiment, the loiter capture algorithm simultaneously drives the vehicle onto the desired ellipse at the desired heading utilizing the biased pursuit guidance law and the ellipse tangent lines.

[0212] FIG. 18, in accordance with one embodiment, is a schematic chart demonstrating that, for any point, P, outside of the ellipse there exist two lines passing tangent to the ellipse and containing the point P. The arrows in the figure indicate a desired direction of travel along the ellipse. Although there are two tangent line solutions, accounting for the desired direction of travel reduces the problem to one solution. Upon entrance into loiter capture, the guidance algorithm illustratively solves for the ellipse tangent line that will bring the vehicle onto the ellipse headed in the desired direction of travel along the ellipse. A biased pursuit guidance law is then illustratively used to control the vehicle along the computed tangent line.

[0213] In accordance with one embodiment, the position of the vehicle is first computed relative to the loiter pattern center in ellipse coordinates as follows:

$$\vec{P}_{rel}^E = T_{ECEF}^E (\vec{P}_{UAV}^{ECEF} - \vec{P}_S^{ECEF}) - \vec{P}_{center} \quad \text{Eq. 27}$$

[0214] where

[0215]  $\vec{P}_{UAV}^{ECEF}$  = ECEF UAV position

[0216]  $\vec{P}_S^{ECEF}$  = ECEF surveillance point location

[0217]  $\vec{P}_{center}$  = ellipse center location relative to surveillance point in ellipse coordinates

[0218] The tangent point on the ellipse is then computed:

$$x_r = \quad \text{Eq. 28}$$

$$\begin{cases} -\frac{b\sqrt{y_v^2 - a^2}}{y} & x_v = 0 \\ b^2 \left( -1 + \frac{1}{2} \frac{y_v (2b^2 y_v + 2\sqrt{a^2 x_v^4 - a^2 x_v^2 b^2 + b^2 y_v^2 x_v^2})}{a^2 x_v^2 + b^2 y_v^2} \right) & x_v > 0 \\ b^2 \left( -1 + \frac{1}{2} \frac{y_v (2b^2 y_v - 2\sqrt{a^2 x_v^4 - a^2 x_v^2 b^2 + b^2 y_v^2 x_v^2})}{a^2 x_v^2 + b^2 y_v^2} \right) & x_v < 0 \end{cases} \quad \begin{matrix} x_v = 0 \\ x_v > 0 \\ x_v < 0 \end{matrix}$$

$$y_r = \begin{cases} \frac{a^2}{y_v} & x_v = 0 \\ \frac{1}{2} \frac{(2b^2 y_v + 2\sqrt{a^2 x_v^4 - a^2 x_v^2 b^2 + b^2 y_v^2 x_v^2}) a^2}{a^2 x_v^2 + b^2 y_v^2} & x_v > 0 \\ \frac{1}{2} \frac{(2b^2 y_v - 2\sqrt{a^2 x_v^4 - a^2 x_v^2 b^2 + b^2 y_v^2 x_v^2}) a^2}{a^2 x_v^2 + b^2 y_v^2} & x_v < 0 \end{cases}$$

[0219] where

[0220]  $x_v = P_{rel_x}^E$  = vehicle x position relative to ellipse center

[0221]  $y_v = P_{rel_y}^E$  = vehicle y position relative to ellipse center

[0222] The desired heading is then computed as:

$$\Psi_D = \tan^{-1} \left( \frac{a^2 x_r}{b^2 y_r} \right) - \pi \quad \text{Eq. 29}$$

[0223] The horizontal acceleration command is formulated in the ellipse capture bearing reference frame. Hence a transformation matrix from the ellipse reference frame to the capture bearing reference frame ( $T_E^B$ ) is computed.

$$T_E^B = \begin{bmatrix} \cos(\Psi_D) & -\sin(\Psi_D) & 0 \\ \sin(\Psi_D) & \cos(\Psi_D) & 0 \\ 0 & 0 & 1 \end{bmatrix} \quad \text{Eq. 30}$$

[0224] The vehicle heading error relative to the ellipse capture bearing is computed as:

$$\Delta\Psi = \Psi_D - \Psi_1 + \Psi_E \quad \text{Eq. 31}$$

[0225] where

[0226]  $\Psi_1$  = vehicle ground track angle

[0227]  $\Psi_E$  = ellipse heading relative to north

[0228] The position error relative to the ellipse tangent point is computed in the capture bearing reference frame.

$$\Delta \vec{P}^\beta = T_E^\beta \begin{Bmatrix} P_{rel_x}^E - x_i \\ P_{rel_y}^E - y_i \\ P_{rel_z}^E \end{Bmatrix} \quad \text{Eq. 32}$$

[0229] The horizontal acceleration command is computed using the biased pursuit guidance law:

$$a_{c_h} = -k_p \Delta P_x^\beta + k_v |\nabla_1| \Delta \Psi \quad \text{Eq. 33}$$

[0230] The total local vertical acceleration command vector is computed as follows:

$$\vec{a}_c^{LV} = [T_{LV}^E]^T [T_E^\beta]^T \begin{Bmatrix} a_{c_h} \\ 0 \\ k_p \Delta P_z^\beta - k_v V_{1z} + |g| + k_p k_{FF2.1} V_c \end{Bmatrix} \quad \text{Eq. 34}$$

[0231] where

[0232]  $V_c$  =Airspeed command

[0233]  $|g|$  =9.81

[0234] This acceleration command vector is then processed through a translation function that generates native vehicle autopilot commands.

[0235] As has been alluded to, the present invention also accommodates racetrack and figure-8 path orbit control. FIG. 19 is a schematic diagram demonstrating various segments of the racetrack and figure-8 patterns.

[0236] In one embodiment, the guidance laws used for racetrack orbit patterns are a combination of the waypoint guidance laws and the ellipse guidance laws. The waypoint guidance law is used during the straight leg segments of the orbit patterns and the ellipse guidance law is used during the turn segments of the orbit patterns. The turn segments are constant radius; therefore the conic equations are simplified over that of the ellipse.

[0237] In one aspect of the present invention, the description will now turn to an explanation of mathematical algorithms (step-by-step) for computing a desired vehicle location along the orbit pattern inertial path. This desired location is illustratively an instantaneous point in three-dimensional space that is used to formulate guidance errors. The guidance algorithms for the racetrack and figure-8 patterns illustratively follow the same processing as the ellipse guidance law with slight computational variations that can be noted in the calculations that follow. These calculations are based on the orbit pattern reference point and orbit pattern size and orientation selected by the operator either graphically during real-time route editing or a priori during mission planning. The vehicle enters and exits an orbit pattern via an entrance path and an exit path, respectively. The entrance path to an orbit pattern and the exit path from the orbit pattern are defined as follows: 1) The path from the waypoint preceding an orbit pattern to the orbit pattern is defined as the tangent line to the orbit pattern that passes through the waypoint (algorithmic computations defined below); and 2) The path from the orbit pattern to the waypoint preceding the orbit pattern is defined as the tangent line to the orbit pattern that passes through the waypoint (algorithmic computations defined below). The

orbit pattern desired location computations are defined below. The coordinate frame definitions and transformations were previously defined.

[0238] In accordance with one embodiment, the processing steps for orbit pattern desired location computations proceed as follows:

[0239] STEP ONE—Compute the ECEF position of the orbit pattern reference point:

$$\vec{P}_{ref}^{ECEF} = geo2ecef(\lambda, l, h) \quad \text{Eq. 35}$$

[0240] where

[0241]  $\vec{P}_{ref}^{ECEF}$  =ECEF position vector of reference point

[0242]  $\lambda$  =Geodetic latitude of reference point

[0243]  $l$  =Geodetic longitude of reference point

[0244]  $h$  =Ellipsoidal altitude of reference point

[0245] NOTE: “geo2ecef” represents the coordinate transformation defined herein within the Section entitled “Coordinate Frame Definitions”

[0246] STEP TWO—Compute the ECEF position of the orbit pattern centroid using the local vertical offset vector (the vertical component of this offset vector is zero).

$$\vec{P}_c^{ECEF} = \vec{P}_{ref}^{ECEF} + T_{ECEF}^{LV} \vec{P}_{offset} \quad \text{Eq. 36}$$

[0247] where

[0248]  $T_{ECEF}^{LV}$  =Local vertical to ECEF transformation matrix

[0249]  $\vec{P}_{offset}$  =Local vertical offset vector (vertical component is zero)

[0250] STEP THREE—The (x,y) coordinates of the orbit pattern relative to the orbit pattern centroid at the current angle,  $t$ , in the orbit pattern reference frame are computed as follows (the z-component of the vector is zero; a is the orbit pattern semi-major axis length and b is the orbit pattern semi-minor axis length):

$$\Delta P_x^{ELL} = b \sin(t_i)$$

$$\Delta P_y^{ELL} = \begin{cases} a \cos(t_i) & \text{ellipse} \\ a - b(1 - \cos(t_i)) & \{\text{racetrack} \ \& \ -\frac{\pi}{2} \leq t \leq \frac{\pi}{2}\} \\ -a + b(1 - \cos(t_i)) & \text{otherwise} \end{cases}$$

$$\text{where } \zeta = \cos^{-1}\left(\frac{b}{a-b}\right)$$

$$\vec{P}^{ECEF} = \vec{P}_c^{ECEF} + [T_{ECEF}^E]^T \Delta \vec{P}^{ELL}$$

$$\text{where } \vec{P}^{ELL} = \begin{Bmatrix} \Delta P_x^{ELL} \\ \Delta P_y^{ELL} \\ 0 \end{Bmatrix}$$

T

$$[T_{ECEF}^E] = \text{Transpose of } ECEF \text{ to ellipse coordinate}$$

transformation matrix

[0251] STEP FOUR—Rotate the orbit pattern coordinate into the ECEF reference frame:

$$\vec{P}^{ECEF} = \vec{P}_c^{ECEF} + [T_{ECEF}^E]^T \Delta \vec{P}^{ELL} \tag{Eq. 38}$$

where  $\vec{P}^{ELL} = \begin{bmatrix} \Delta P_x^{ELL} \\ \Delta P_y^{ELL} \\ 0 \end{bmatrix}$

$T_{ECEF}^E$  = Transpose of ECEF to ellipse coordinate transformation matrix

[0252] STEP FIVE—Compute the latitude and longitude of the orbit pattern coordinate:

$$(\lambda_p, l_p, h_i) = ecef2geo(\vec{P}^{ECEF}) \tag{Eq. 39}$$

[0253] NOTE: “ecef2geo” represents the inverse of the “geo2ecef” coordinate transformation defined herein within the Section entitled “Coordinate Frame Definitions”

[0254] STEP SIX—Pass the computed parameters to the guidance law for computation of the autopilot command inputs (e.g., utilizing the algorithms were defined in the preceding sections).

[0255] The UAV enters a racetrack orbit pattern along a capture path that passes tangent to the orbit pattern. This is

the desired capture path due to the fact that the horizontal acceleration command at the point of the capture will be effectively zero, indicating that the vehicle does not require a correction to establish the orbit course at the time of capture.

[0256] In accordance with one embodiment, the processing steps for waypoint to orbit pattern segment calculation proceed as follows (the following algorithm applies to both the preceding and proceeding waypoint paths):

[0257] STEP ONE—Using the ECEF location of the orbit pattern centroid computed in steps 1 and 2 of the orbit pattern desired location computation algorithm compute the position of the waypoint (either preceding or proceeding the orbit pattern, whichever the case may be) relative to the orbit pattern centroid in the ellipse reference frame as follows:

$$\Delta \vec{P}_v^{ELL} = T_{ECEF}^E (\vec{P}_w^{ECEF} - \vec{P}_c^{ECEF}) \tag{Eq. 40}$$

[0258] where

[0259]  $\Delta \vec{P}_v^{ELL}$  = waypoint position relative to orbit pattern center in ellipse reference frame

[0260]  $\vec{P}_w^{ECEF}$  = waypoint ECEF position

[0261]  $\vec{P}_c^{ECEF}$  = orbit pattern centroid ECEF position

[0262]  $T_{ECEF}^E$  = ECEF to ellipse reference frame coordinate transformation matrix

[0263] STEP TWO—Compute the orbit pattern tangent point which lies on the line passing through the waypoint:

$$x_t = \begin{cases} -k \frac{b\sqrt{y_v^2 - a^2}}{y_v} & x_v = 0 \\ b^2 \left( -1 + \frac{1}{2} \frac{y_v (2b^2 y_v + 2k\sqrt{a^2 x_v^4 - a^2 x_v^2 b^2 + b^2 y_v^2 x_v^2})}{a^2 x_v^2 + b^2 y_v^2} \right) & x_v > 0 \\ b^2 \left( -1 + \frac{1}{2} \frac{y_v (2b^2 y_v - 2k\sqrt{a^2 x_v^4 - a^2 x_v^2 b^2 + b^2 y_v^2 x_v^2})}{a^2 x_v^2 + b^2 y_v^2} \right) & x_v < 0 \end{cases} \tag{Eq. 41}$$

$$y_t = \begin{cases} \frac{a^2}{y_v} & x_v = 0 \\ \frac{1}{2} \frac{(2b^2 y_v + 2k\sqrt{a^2 x_v^4 - a^2 x_v^2 b^2 + b^2 y_v^2 x_v^2}) a^2}{a^2 x_v^2 + b^2 y_v^2} + kd & x_v > 0 \\ \frac{1}{2} \frac{(2b^2 y_v - 2k\sqrt{a^2 x_v^4 - a^2 x_v^2 b^2 + b^2 y_v^2 x_v^2}) a^2}{a^2 x_v^2 + b^2 y_v^2} - kd & x_v < 0 \end{cases}$$

where  $b$  = semi-minor axis (half orbit region box width)  
 $a$  =  $\begin{cases} \text{semi-major axis (half orbit region box length)} & \text{ellipse} \\ b & \text{racetrack} \end{cases}$   
 $d$  = (half orbit region box length) - (half orbit region box width)

-continued

$$k = \begin{cases} 1 & \text{for preceding waypoint} \\ -1 & \text{for proceeding waypoint} \end{cases}$$

$$x_v = \Delta \vec{P}_v^{ELL}(x)$$

$$y_v = \begin{cases} \Delta \vec{P}_v^{ELL}(y) & \text{ellipse or } x_v = 0 \\ \Delta \vec{P}_v^{ELL}(y) - kd & \text{\{racetrack\} and } x_v > 0 \\ \Delta \vec{P}_v^{ELL}(y) + kd & \text{\{racetrack\} and } x_v < 0 \end{cases}$$

[0264] STEP THREE—Rotate the orbit pattern tangent point into the ECEF reference frame:

$$\vec{P}_t^{ECEF} = \vec{P}_c^{ECEF} + [T_{ECEF}^E]^T \Delta \vec{P}_t^{ELL} \tag{Eq. 42}$$

where  $\Delta \vec{P}^{ELL} = \begin{bmatrix} x_t \\ y_t \\ 0 \end{bmatrix}$

$[T_{ECEF}^E]^T =$  Transpose of ECEF to ellipse coordinate transformation matrix

[0265] STEP FOUR—Compute the latitude and longitude of the orbit pattern tangent point:

$$(l_t, h_t) = \text{cef2geo}(\vec{P}_t^{ECEF}) \tag{Eq. 43}$$

[0266] STEP FIVE—Insert a waypoint leg connecting the waypoint and the computed orbit pattern tangent point

[0267] FIG. 20 is a schematic diagram demonstrating an example of a programmed route using the defined loiter algorithms. Within FIG. 20, items 4, 7, and 9 represent orbit patterns and the remaining numbered elements represent waypoints. In accordance with one embodiment, the orbit guidance laws are configured to allow the operator to input either a desired orbit time or a desired number of orbit laps. The UAV will exit the orbit pattern when either the specified orbit time or specified number of orbit laps has been completed.

[0268] An interesting characteristic of the loiter pattern embodiments of the present invention is that one is able to mathematically define a desired location on a path in association with a given point in time. Points can be defined relative to a center point, even relative to a moving center point.

[0269] C. Remote Directional Command Mode

[0270] In accordance with one aspect of the present invention, as is inferred by block 140 in FIG. 1, a remote directional command (RDC) control mode is implemented. The versatility of the overall control system design of the described VACS architecture makes implementation of an RDC control mode relatively straightforward.

[0271] Inertial turn rates are kinematically related to acceleration through multiplication of the inertial velocity magnitude ( $a=V\omega$ ). Hence, in the horizontal channel, an acceleration command can be generated for the autopilot by multiplying a desired or commanded turn rate by the inertial

velocity magnitude. To accomplish this guidance law, the operator’s horizontal control stick input is linearly mapped to a horizontal turn rate command in which the maximum stick position is equal to the maximum allowable horizontal turn rate.

[0272] The vertical channel manual control mode is a little different. For most UAV applications the vertical stick position will translate into a climb/descent rate command. It is more intuitive for operators to control the vertical channel via climb rate. Hence, in accordance with one embodiment, a look-up table of climb performance as a function of vehicle state (altitude and airspeed) is incorporated into the algorithms (the table is illustratively programmable to accommodate multiple UAV platforms). On each pass through the guidance software, the maximum climb rate is computed. The vertical control stick location is then linearly mapped to this maximum climb rate (center stick=zero climb rate, max stick=max climb rate). This climb rate command is then used to compute a flight path angle (gamma) command, which is fed into a gamma control guidance law (defined later in this section). A combination of control input device rate limiting and guidance command rate limiting illustratively results in a robust design that prevents the operator from being able to overdrive, stall, spin or in any other way crash the vehicle.

[0273] It should be noted that practically any known commercial control input device can be utilized for RDC control without departing from the scope of the present invention. For example, a USB game pad can be utilized thereby providing relative compactness and versatility. In accordance with one embodiment, the game pad utilized has a throttle slide control, a plurality of control buttons, and two thumb control sticks—one of which is used to steer the UAV and the other used to steer the UAV imaging sensor.

[0274] In accordance with one aspect of the present invention, the control system software translates the vehicle control stick motion as follows:

[0275] 1. Forward (away from the operator)—descent rate command

[0276] 2. Backward (toward the operator)—climb rate command

[0277] 3. Left—left turn rate command

[0278] 4. Right—right turn rate command

[0279] The raw stick position readings are illustratively calibrated and normalized to range from -1.0 to 1.0 in both channels where (0,0) represents the center (neutral) stick position. When the stick is in the neutral position (0,0), the

vehicle flies a straight and level profile. In accordance with one embodiment, the off-board control system software (i.e., the software resident on the ground station) maps the stick range limits as follows:

[0280] 1. Maximum horizontal stick position ( $\pm 1$ )—max vehicle turn rate

[0281] 2. Maximum forward stick position (+1)—max vehicle descent rate

[0282] 3. Maximum aft stick position (-1)—max vehicle climb rate

[0283] In one aspect of the present invention, the vehicle max climb rate is a function of altitude and airspeed. The off-board control software illustratively maintains a database of the vehicle max climb rate and interpolates based on current flight conditions to obtain the instantaneous control limit. This methodology will prevent the operator from overdriving the vehicle. A similar methodology is used for descent rate, although the descent rate is not as restrictive as the climb rate and requires a more empirical approach to setting.

[0284] In accordance with one aspect of the present invention, the following equations define the basic simplified manual control approach. The algorithm maintains a set of vertical and horizontal reference conditions that are used to command the vehicle when the operator lets go of the stick. First, the vertical stick position is checked for movement and the associated vertical commands and reference conditions are computed:

$$\text{if } |\delta_{v_i} - \delta_{v_{i-1}}| > \varepsilon$$

$$H_{ref} = H$$

$$R = 0$$

else

$$R_i = R_{i-1} + V_{horz} \Delta t$$

endif

$$\dot{H}_c = \delta_{v_1} \dot{H}_{max}$$

$$\gamma_c = \sin^{-1} \left( \frac{\dot{H}_c}{V_1} \right)$$

where  $\delta_v$  = vertical control stick position

$\varepsilon$  = control stick measurement noise/freeplay tolerance

$H_{ref}$  = reference altitude

$H$  = vehicle altitude

$R$  = integrated path length during vertical maneuver

$\dot{H}_c$  = climb/descent rate command

$\dot{H}$  = vehicle altitude rate

$\gamma_c$  = flight path angle command

$V_1$  = vehicle inertial velocity magnitude

[0285] Next, the horizontal stick is checked for movement and the associated horizontal commands and reference conditions are computed:

$$\text{if } |\delta_h| > \varepsilon$$

Eq. 45

$$\Psi_c = \delta_h \Psi_{max}$$

$$\Psi_{ref} = \Psi_t$$

$$\vec{P}_{ref}^{LV} = \{0, 0\}^T$$

else

$$\vec{P}_{ref_i} = \vec{P}_{ref_{i-1}}^{LV} + \vec{V}_h \Delta t$$

$$[0286] \vec{P}_{ref}^W = T_{LV}^W \vec{P}_{ref}^{LV}$$

endif

[0287] where

[0288]  $\delta_h$  = horizontal control stick position

[0289]  $\Psi_c$  = horizontal turn rate command

[0290]  $\Psi$  = horizontal turn rate

[0291]  $\Psi_{ref}$  = reference heading

[0292]  $\Psi_t$  = vehicle ground track angle

[0293]  $\vec{P}_{ref}$  = reference position

[0294] The above equations illustrate how trajectory synthesis is employed to guide the vehicle on a straight and level path when the control stick is returned to zero. This synthesis technique generates an inertial path to which the

Eq. 44

vehicle guides, thus ensuring that inertial sensor errors do not cause the vehicle to deviate from the operator's expected course.

[0295] The airspeed command is computed based on the slide control setting:

$$V_c = V_{\min} + \delta_t (V_{\max} - V_{\min}) \quad \text{Eq. 46}$$

[0296] where

[0297]  $\delta_t$  = slide control setting

[0298] Any of a variety of vertical channel control schemes can be implemented without departing from the scope of the present invention, including both position and velocity reference control laws. It is intuitively obvious that when the operator commands a climb or descent via the manual control operation, the only altitude of concern is the altitude at which to level off. Hence, the actual implementation of the control law does not require a position-slave component. This reduces the order of the control law to a first order control law in which the velocity command term is acted upon to generate an acceleration command to the autopilot. In accordance with one embodiment, the following perturbational first-order control law is illustratively used for the altitude rate control:

$$a_{c_{up}} = \frac{|V_1|}{\tau} (\gamma - \gamma_c) - g \quad \text{Eq. 47}$$

where

$a_{c_{up}}$  = local vertical UP acceleration command

$\gamma$  = flight path angle

$\gamma_c$  = flight path angle command =  $\sin^{-1} \left( \frac{\dot{h}_c}{V} \right)$

$\dot{h}_c$  = altitude rate command

$\tau$  = guidance law time constant

$g$  = acceleration of gravity

$|V_1|$  = inertial velocity magnitude

[0299] In one embodiment, the time constant is a tunable parameter that can be adjusted for specific platforms. For example, the time constant used for a given vehicle might be 0.3 seconds, whereas the time constant used for another vehicle might be 0.1 seconds. The vertical channel guidance generally works in coordination with the automatic speed control loop. In other words, simply commanding a constant throttle setting as opposed to a constant speed setting can easily drive the vehicle into a stall condition when maximum (or near maximum) climb rates are commanded. By including the automatic speed control design and mapping the operator's "throttle" control input to a speed command as opposed to a throttle setting the problem is alleviated.

[0300] In accordance with one embodiment, the horizontal acceleration command is computed as

$$a_{c_h} = \begin{cases} -k_p \ddot{P}_{ref}^W(\text{across}) - k_v |V_{horz}| (\Psi_t - \Psi_{ref}) & |\delta_h| \leq \epsilon \\ V_1 \Psi_c & |\delta_h| > \epsilon \end{cases} \quad \text{Eq. 48}$$

[0301] It should be noted that when the horizontal stick is in the neutral location a biased pursuit guidance law is used to maintain a constant heading. The local vertical acceleration command vector is then illustratively computed as:

$$\vec{a}_c^{LV} = \begin{Bmatrix} a_{c_h} \cos(\Psi_t) \\ -a_{c_h} \sin(\Psi_t) \\ a_{c_{UP}} \end{Bmatrix} \quad \text{Eq. 49}$$

[0302] This acceleration command vector is then illustratively processed through a translation layer and delivered to the autopilot system.

[0303] An additional aspect of the present invention pertains to control stick command rate limiting. A key desired objective of the simplified manual control modes described herein is that the control modes will resist the operator's ability to overdrive the vehicle. In accordance with one embodiment, a robust, algorithmic approach to aid in the achievement of this objective is to implement a rate limit on the operator's control stick command inputs. A simple rate-limiting algorithm has a dynamic effect similar to passing the commands through a low-pass filter. The rate limiting essentially attenuates high frequency command inputs. The benefit to the controller is that rate limiting the command inputs enables an elimination of high frequency "jerks" from the command stick. Further an avoidance is enabled of inadvertent and unnecessarily large steps and high frequency impulses directed to the controller. This, in turn, minimizes the transient effects of the closed-loop on the human operator's perception of the vehicle response to his/her commands. In other words, with the control stick rate limiting algorithm functioning, the operator always sees the vehicle respond smoothly to the directional commands that he/she is supplying. In accordance with one embodiment, the control stick rate limiting is a tunable parameter within VACS and can be adjusted to satisfy the specific performance desires of a given operator with a given vehicle under VACS control.

[0304] Another aspect of the present invention pertains to an automatic speed control loop. Important to the application of a robust simplified manual control capability is the ability of the embedded controller to maintain speed, even through harsh maneuvering environments. Consider a scenario wherein an operator commands a hard turn, a max climb, or a combined climb and turn maneuver, the VACS controller will rapidly orient the vehicle into the desired maneuver (flight path and turn rate). The maneuver, in turn, will require the vehicle to pull a large angle-of-attack, which results in increased drag, or to fly a glide slope in which the effects of gravity in the axial channel are significant enough to induce a rapid deceleration. To expect the operator to keep up this rapidly changing dynamic environment by manually

adjusting the throttle would directly oppose the goal of the simplified manual control design. Hence, in accordance with one embodiment of the present invention, an automatic speed control loop is coupled into the system. A basic implementation allows the operator to enter a preprogrammed speed setting (cruise for best range, cruise for best endurance, cruise at max speed, etc) or a manual speed setting using a typical joystick throttle input. For the manual speed setting, the control stick throttle setting is not mapped to throttle setting, but rather mapped to a speed command that is linearly proportional to the control setting. In other words, the minimum control setting maps to the vehicle minimum control speed and the maximum control setting maps to the vehicle maximum cruise speed. The remaining settings are mapped linearly between the min and max speeds.

[0305] As the vehicle decelerates through commanded maneuvers, the automatic speed loop responds and adjusts the throttle setting to maintain the desired speed programmed by the operator. Even as the operator adjusts his manual speed control, the flight software is simply adjusting the speed command to the autospeed loop, which is always running. The advantage is that the bandwidth of the control system is higher than the bandwidth of a human operator; hence, using VACS, the operator generally cannot command a maneuver that ultimately drives the vehicle to stall—the flight computer is continuously adjusting the throttle to maintain the proper speed setting.

[0306] Another aspect of the present invention pertains to climb gradient limiting. When mapping the vertical control stick command to a climb rate command, the vehicle climb rate performance capability is illustratively taken into account. The maximum climb rate of the vehicle directly corresponds to the maximum vertical control stick deflection. When a combined climb and turn maneuver is commanded, the net reduction in climb rate capability resulting from the out-of-plane acceleration component required to generate the turn rate is accounted for. There is a closed form analytic climb rate reduction that can be computed to account for the turn. In accordance with one embodiment, this reduction in climb rate is computed as:

$$\Delta \dot{h} = - \frac{2 \frac{\partial C_D}{\partial (C_L^2)} m^2 \Psi^2 V}{\rho g S_{ref}} \quad \text{Eq. 50}$$

where

$$\frac{\partial C_D}{\partial (C_L^2)} = \text{vehicle drag polar constant } (k)$$

$m$  = vehicle mass

$\Psi$  = turn rate command

$V$  = inertial velocity

$\rho$  = air density

$g$  = acceleration of gravity

$S_{ref}$  = aerodynamic reference area

[0307] The maximum climb rate used to generate the flight path reference command during the manual control mode is reduced by the amount computed using the above equation.

The combination of this reduction, along with the limiting algorithms and speed control loop discussed in the preceding sections offers a robust manual control system design that prevents the operator from overdriving the UAV.

[0308] D. Line-of-Sight Slave Control Mode

[0309] In accordance with one aspect of the present invention, as is indicated by block 136 in FIG. 1, a line-of-sight (LOS) slave control mode is implemented. The versatility of the overall control system design of the described VACS architecture makes implementation of this control mode relatively straightforward.

[0310] The underlying operational concept of the LOS slave control mode is illustratively defined by the fact that the operator is ultimately interested in the imagery captured and transmitted by the UAV. The goal of the guidance mode therefore becomes to offer the operator the capability to manually slew the UAV sensor while surveying a battlefield or other topological region with complete disregard for the aviation or direction of the UAV. To accomplish this guidance objective, the vehicle is slaved to the sensor line-of-sight. To maximize the operator's probability of visual object recognition, the guidance policy is to align the heading of the UAV to the horizontal sensor line-of-sight. With this policy, the vehicle is always commanding a path toward the desired surveillance area. A simple pursuit guidance law is employed to achieve the stated guidance goal.

[0311] In accordance with one embodiment of LOS slave control, the applicable guidance law commands the nose of the UAV to align with centerline of the gimbaled sensor by issuing the following horizontal acceleration command:

$$a_{c_{rh}} = \begin{cases} -k_p \ddot{P}_{ref}^W(\text{across}) - k_v |V_{horz}| (\Psi_r - \Psi_{ref}) & |\delta_h| \leq \epsilon \\ -K_V |V_1| \Delta \Psi & |\delta_h| > \epsilon \end{cases} \quad \text{Eq. 51}$$

[0312]  $\Delta \Psi$  represents the angle between the vehicle centerline and the sensor horizontal line-of-sight angle. The sensor horizontal line-of-sight angle is derived from the platform gimbal angles.

[0313] Generally speaking, the directional-response autopilot, combined with the stabilized platform, allows a single minimally trained operator to easily conduct a UAV surveillance mission. A further level of user simplification is achieved by combining seeker designation command logic with the outer loop guidance. This mixing provides Line-of-Sight Slave mode capability in which the operator's point of reference is the image scene transmitted from the UAV's on-board camera. In this mode the operator does not provide direction commands to the UAV. Instead, the operator focuses his attention on the tactical situation display, commanding the look angle of the UAV's on-board sensor to survey the battlefield (or other topographical region for non-military applications) while the UAV autonomously commands a flight profile which is slaved to the operator's sensor line-of-sight commands. This integration of the camera platform with the guidance provides the following benefits:

[0314] 1. Time-on-station loiter control which can be easily selected and designated.

[0315] 2. Further reduction of workload on the operator, who can now focus primarily on the surveillance aspects of the mission.

[0316] 3. An easily adaptable relative Navigation method.

[0317] FIG. 21 is a diagrammatic illustration demonstrating how LOS slave control is implemented with the ground station display in accordance with one aspect of the present invention. The display is illustratively a top-view with a schematic of the aircraft for easier conceptualization. The outer circle around the aircraft is illustratively a projection of the entire field-of-view onto the ground. The smaller pie-shaped queue is illustratively a ground projection of the current seeker borsight position. These are calculated by the ground station software from the positional information and seeker angle sent across the data-link. The remote operator can illustratively opt to either keep the cursor active as the continual steering point, or he/she can designate a “surveillance-point” by clicking on a desired ground location. In the latter case, the staring point would be captured so the cursor could be moved to a new constant location.

[0318] If the pilot chooses a surveillance location outside the total FOV, then the outer loop guidance will illustratively follow a command-to-LOS mode guide law until the UAV flight path points toward the target. Once the desired staring-point comes within a minimum range threshold, the guidance automatically trips into a loiter pattern (either constant-radius or elliptical) to maintain a station with a single key-click while he/she conducts other activities. FIGS. 22A & 22B together demonstrate the surveillance-point approach scenario.

[0319] If a constant location is selected within the minimum turning radius, then the guidance will fly over the surveillance-point and plan an out-and-back pattern to avoid a singularity in the loiter guide-law. This can be easily achieved by inserting waypoint legs autonomously. If the operator chooses, he/she can select a standoff range (or accept the default range) for surveillance over a hostile target. The line-of-sight commands will also comprehend the offset location to track on the desired location. This is achieved by inserting the offset range vector in the positional component of the loiter guide-law.

[0320] The following simplified equations are used to show the basic structure of the LOS Slave mode guidance:

$$\begin{aligned}
 &\text{If } (R_{Target} > \text{Loiter\_Threshold}) \text{ then} && \text{Eq. 52} \\
 &\quad \dot{\psi}_{Cmd} = K_{\psi} (\lambda_{Horiz} - \psi_{Heading}) \\
 &\quad \dot{\gamma}_{Cmd} = K_H (H_{CMD} - H) + H_H \dot{H} + \frac{g}{V} \\
 &\quad \text{else} \\
 &\quad \dot{\psi}_{Cmd} = K_{\psi} \Delta\Psi + K_P (P_{Turn} - \|R_{Target} + \bar{R}_{Stand-Off}\|) \\
 &\quad \dot{\gamma}_{Cmd} = K_H (H_{CMD} - H) + K_H \dot{H} + \frac{g}{V} \\
 &\quad \text{endif} \\
 &\quad \text{where} \\
 &\quad R_{Target} = \text{Horizontal Range-to-Target} \\
 &\quad \dot{\psi}_{Cmd} = \text{Horizontal Turning Rate Command}
 \end{aligned}$$

-continued

$\Delta\Psi$  = Heading Error Relative To Loiter Path

$\lambda_{Horiz}$  = Horizontal Line-of-Sight to Target

$\dot{\gamma}_{Cmd}$  = Vertical Turning Rate Command

$\Psi_{Heading}$  = Heading Angle

$P_{Turn}$  = Loiter Turning Radius

$H$  = Altitude

$g$  = Gravity Acceleration Magnitude

$V$  = Vehicle Inertial Velocity Magnitude

[0321] The above equations show two active horizontal guidance terms when flying the constant turning radius circle. The first term is the damping term which drives the vehicle to align its ground track with the desired circular loiter pattern and is the dominating term. The second term is a positional term to help maintain the constant arc.

[0322] In accordance with one aspect of the present invention, sensor-slave mode commands are generated by an autonomous line-of-sight driven function, in which the command objectives are generated by the necessities of the function rather than by an operator. For example, a function designed to command a raster-scan of a particular surveillance area, or a function designed to scan a long a roadway could be used to generate sensor slave commands. Another example is a function designed to generate line-of-sight commands for UAV-to-UAV rendezvous formation flying.

[0323] E. Ground Collision Avoidance System (GCAS)

[0324] In accordance with one aspect of the present invention, as is indicated by block 120 in the FIG. 1 architecture, a ground collision avoidance system (GCAS) provides an automated mechanism enabling the control system to avoid terrain without having to task the operator with studying altitude above ground for each vehicle under his or her control. In accordance with one embodiment, the GCAS provides the operator with some form of situational awareness information about an upcoming collision (e.g., a warning signal). If the user does not react to that information, the GCAS will automatically avoid the terrain and let the user know the system is in an auto-avoidance mode. During this mode, the user is illustratively locked out from making flight path changes until the system has cleared the offending terrain.

[0325] In accordance with one embodiment, the operator is provided with a timer display that counts down a time period within which the operator can manually avoid a high potential terrain collision. If the operator does not manually steer off of the collision path during the time period, then the GCAS will initiate the auto-avoidance mode.

[0326] In accordance with one embodiment, an altitude profile sensor is set up to provide data for GCAS purposes. While other known sensors can be utilized without departing from the scope of the present invention, one suitable ground terrain sensor system is the Digital Terrain Elevation Data (DTED) Level 1 database available from the National Imagery and Mapping Agency (NIMA). The spacing for Level 1 DTED is approximately 93 meters, which somewhat limits



the amount of surface information the GCAS algorithm uses. However, the GCAS algorithm is illustratively generic and can accept Level 2 DTED for a higher resolution model. It should be noted that it is also within the scope of the present invention to adopt even more advanced terrain description mechanisms to provide terrain topology map information for the ground collision avoidance logic.

[0327] In accordance with one embodiment, a first input to the GCAS is a desired clearance height above terrain for a vehicle to be controlled. Once the desired clearance has been defined, the GCAS algorithm produces a terrain altitude profile. The profile is created from the DTED maps using a scan pattern that accounts for Navigation and DTED errors.

[0328] FIG. 23 is a schematic representation of a top view of a scan pattern within the context of the GCAS. The scan pattern starts at the vehicle position. A horizontal uncertainty box is generated. A maximum terrain altitude is then calculated within the uncertainty box. The uncertainty box is then propagated forward adjusting for heading and any other uncertainty. The algorithm then determines the maximum altitude in the new uncertainty boxes and continues forward an amount to occupy a limited fly-out time (e.g., a 60 second fly-out). The maximum values for these uncertainty boxes are used to feed the terrain profile for the GCAS guidance.

[0329] The philosophy behind the design of the GCAS system is to take the current vehicle position and fly out a medium fidelity simulation as if the operator had commanded a maximum g pull up. While the simulation performs this pull up, the algorithm monitors vehicle altitude and ground altitude and attempts to predict at what point the vehicle will intersect the terrain.

[0330] FIG. 24 is a schematic diagram demonstrating of a sample trajectory. Assuming the vehicle is flying with current velocity  $V_c$ , the algorithm starts at the current vehicle position and flies a maximum g pull up trajectory. The maximum g pull up is an acceleration command generated according to the following equation:

$$a_c = \frac{QSC_{L_{max}}}{m} \tag{Eq. 53}$$

where

$Q$  = dynamic pressure

$S$  = vehicle aerodynamic reference area

$C_{L_{max}}$  = vehicle maximum lift coefficient

$m$  = vehicle mass

[0331] The algorithm then assumes a constant initial velocity and projects the trajectory along the velocity line to estimate a time to fly up. The time to fly up represents the time to start the maneuver in order to avoid the terrain by an amount equal to the minimum descent altitude. The minimum descent altitude is a constant and represents the minimum height above the terrain for the platform through the terrain avoidance mode.

[0332] After the algorithm finds the minimum altitude above ground through the fly-out trajectory, the closure rate

is computed based on the initial velocity and the velocity at the minimum altitude above ground.

$$V_c = \frac{V_{H,0} * V_{U,MinAgl} - V_{H,MinAgl} * V_{U,0}}{|\vec{V}_{MinAgl}|} \tag{Eq. 54}$$

[0333] Once the closing rate has been computed, the value is limited (e.g., limited to 2 feet/second) to avoid division by zero problems in the time to fly up calculation.

$$V_c = \max(V_c, 2.0) \tag{Eq. 55}$$

[0334] Once the closure rate computation is complete, the time to fly up is calculated as:

$$TTFU = \frac{(H_{MinAgl} - MDA)}{V_c} \tag{Eq. 56}$$

[0335] The MDA variable represents the minimum descent altitude, or the minimum altitude the vehicle should attain during the climb out. In accordance with one embodiment, the time to fly up is computed periodically (e.g., every 1 Hz) and reported to the operator station (i.e., the ground control station). Should the time to fly up reduce to zero, the guidance code will perform the maximum g pull up maneuver while ignoring any commands from the operator station. Once the fly out is complete and the time to fly up returns to a predetermined threshold (e.g., greater than 10 seconds), control is relinquished and returned to the operator station.

[0336] In accordance with one embodiment, in order to perform the simulation in faster than real time, the high fidelity simulation is updated for computational simplicity. Accordingly, the design flies a paired down version of the vehicle simulation in a faster than real-time environment to estimate when the vehicle might impact the ground. For example, the baseline simulation can be adapted with the following changes:

[0337] Truth Navigation model

[0338] Truth actuator models

[0339] No wind model

[0340] Reduced simulation time step to 16 Hz

[0341] These are examples of changes that can be made to enable performance of a flyout simulation of the vehicle in a faster than real-time environment.

[0342] In accordance with one embodiment, the simulation has the capability to fly out 10 seconds of medium fidelity data and then extrapolate for another 50 seconds of data giving a 1 minute window of simulated data. The data provides time for the max g-pull up maneuver to execute and acquire the desired flight path angle. Once that flight path angle is captured, an inertial propagation for the next 50 seconds provides an accurate assessment of the vehicle motion.

[0343] In accordance with one embodiment, the operator station (e.g., the ground control station including the operator interface) is configured to provide the operator with an opportunity to understand that the vehicle is about to go into a GCAS maneuver. For example, the time to fly up variable

from the GCAS simulation is transmitted to the operator station. If the time to fly up value reduces to a value less than or equal to a predetermined value (e.g., 10 seconds), an indicator is provided to the operator (e.g., the vehicle on the display turns yellow) and a counter is added to show the estimated time to fly up. Should that number reduce to zero, an indication is provided (e.g., the vehicle turns red) showing that the operator no longer has control of the vehicle and the ground collision avoidance maneuver is currently being executed.

**[0344]** IX. Translator

**[0345]** As was described in relation to **FIG. 5**, a translation layer can be implemented to translate guidance commands into reference commands appropriate for the specific autopilot implementation.

**[0346]** In accordance with one embodiment, an exemplary translation layer implementation will now be provided. After the guidance algorithms execute, the outputs are translated to the native vehicle autopilot commands. The equations below provide example kinematic translations from the guidance acceleration commands to native vehicle autopilot commands. These equations demonstrate the principal that vehicle motion is activated through acceleration. The methods that various vehicles employ to generate acceleration are numerous (bank angle autopilot, acceleration autopilot, heading control autopilot, altitude control autopilot, etc). Since the control algorithms described herein generate acceleration commands that can be kinematically translated into any of these native autopilot commands, the guidance algorithms truly provide a generalized library of control laws that can control any vehicle through that vehicle's native atomic functions. Ubiquitous acceleration control techniques enable VACS to synthesize control commands for any vehicle, including air, ground, or sea-based.

$$a_v = \text{vertical plane acceleration command} \quad \text{Eq. 57}$$

$$a_h = \text{horizontal plane acceleration command}$$

$$\phi = \tan^{-1}\left(\frac{a_h}{a_v}\right) = \text{bank angle command}$$

$$a_T = \sqrt{a_v^2 + a_h^2} = \text{total body acceleration command}$$

$$\dot{\psi} = \frac{a_h}{V} = \text{turn rate command}$$

$$\psi_i = \psi_{i-1} + \dot{\psi}\Delta t = \text{heading command}$$

$$\dot{\gamma} = \frac{(a_v - g)}{V} = \text{flight path rate command}$$

$$\gamma_i = \gamma_{i-1} + \dot{\gamma}\Delta t = \text{flight path angle command}$$

$$\dot{h} = V \sin(\gamma) = \text{climb rate command}$$

$$h_i = h_{i-1} + \dot{h}\Delta t = \text{altitude command}$$

**[0347]** Additional functionality that can be enabled in a translation layer is means for discouraging or preventing an operator (e.g., the human or non-human operator interfacing the VACS architecture) from overdriving, stalling, or spinning the vehicle frame. This being said, limiting algorithms can also be employed in the guidance or autopilot functions.

**[0348]** X. Autopilot

**[0349]** As has been addressed, the present invention is not limited to, and does not require, a particular autopilot

system. The control system and architecture embodiments of the present invention can be adapted to accommodate virtually any autopilot system.

**[0350]** For the purpose of providing an example, an illustrative suitable autopilot software system will now be described. The illustrative autopilot system incorporates a three-axis design (pitch and yaw with an attitude control loop in the roll axis) for vehicle stabilization and guidance command tracking. The autopilot software design incorporates flight control techniques, which allow vehicle control algorithms to dynamically adjust airframe stabilization parameters in real-time during flight. The flight computer is programmed directly with the airframe physical properties, so that it can automatically adjust its settings with changes in airframe configuration, aerodynamic properties, and/or flight state. This provides for a simple and versatile design, and possesses the critical flexibility needed when adjustments to the airframe configuration become necessary. The three-loop design includes angular rate feedback for stability augmentation, attitude feedback for closed-loop stiffness, and acceleration feedback for command tracking. In addition, an integral controller in the forward loop illustratively provides enhanced command tracking, low frequency disturbance rejection and an automatic trim capability.

**[0351]** XI. Multi-Vehicle Ground Control Station

**[0352]** In one aspect of the present invention, an operator station (also referred to as the ground control station or GCS) is designed to accommodate command and control of multiple vehicles or a single vehicle by a single operator. In accordance with one embodiment, the ground control station is platform independent and implements an application program interface that provides windowing and communications interfaces (e.g., the platform is implemented in Open Source wxWindows API). The underlying operating system is illustratively masked and enables a developer to code in a high level environment.

**[0353]** In one embodiment, the ground control station incorporates several specialized user interface concepts designed to effectively support a single operator tasked to control multiple vehicles. The GCS also illustratively supports manual control and sensor steering modes. In the manual control mode, the operator can assume control authority of the vehicles individually from the ground control station at any time in flight. In the sensor steering mode, a vehicle will autonomously fly in the direction the operator is manually pointing the on-board imaging sensor (e.g., operator views video output from a digital camera on a TV interface, computer screen display, etc.). A custom data link is illustratively, utilized to support a two-way transfer of data between the ground control station and the UAV's. These design concepts together provide a flexible, multiple vehicle control system. The details of the concepts are discussed below.

**[0354]** In one aspect of the present invention, the ground control station implemented for flight control includes any or all of the following components:

**[0355]** a graphical user interface (GUI)

**[0356]** a synthetic vision display

**[0357]** two video monitors

**[0358]** a laptop computer

- [0359] two repeater displays
- [0360] a hand-held controller
- [0361] a keyboard
- [0362] a mouse control
- [0363] a two-way radio
- [0364] a computer network

[0365] The two video monitors are illustratively used to display real-time data linked camera imagery from two air vehicles having cameras (of course, fewer, more or none of the vehicles might have cameras and the number of monitor displays can be altered accordingly). In accordance with one embodiment, camera imagery is recorded on videotapes during a mission. In accordance with one embodiment, the two repeater displays are used to provide redundant views of the GUI and synthetic vision display. The laptop illustratively serves as a GUI backup in the event that the main GUI fails.

[0366] FIG. 25 is a simplified block diagram of ground control station 2510 in accordance with an embodiment of the present invention. As illustrated, ground control station 2510 receives real-time video images through a video receiver 2512. In accordance with one embodiment, a digital video camera is installed on one or more of the air vehicles for the production of such images. The camera imagery from each camera is illustratively data linked to a dedicated display screen at the ground control station. In accordance with one embodiment, a pan-tilt-zoom color camera is illustratively implemented by being installed on the underside fuselage or the underside of a wing. However, monochrome imagery cameras are also within the scope of the present invention. In accordance with one embodiment, cameras are illustratively operator-controlled from the ground control station via a data link to the vehicle, such as through transceiver 2518.

[0367] Video receiver 2512 captures video from a sensor camera and delivers the imaging data to VCR 2514 for video display and processing such that ground control system 2510 can relay processed video through a USB port to notebook computer 2516 for recording onto a hard disk. Notebook computer 2516 is configured to playback the recorded video stream. Transceiver 2518 receives data from multiple UAV's as well as transmits data to the multiple UAV's. Mode in 2509 supports information transfer to and from notebook 2516. Data transmitted to a UAV includes operator specific information and non-operator specific information. In addition, a power source 2520 is coupled to notebook computer 2516, video receiver 2512, VCR 2514 and a power supply 2522. Power supply 2522 provides power for data transmission.

[0368] Ground control station 2510 incorporates a graphical user interface that places minimal significance on standard "cockpit" displays and focuses on situational displays. The ground control station display is generally reconfigurable so that an operator can customize the information layout to suit his/her specific needs and/or vehicle requirements. An operator interacts with the graphical user interface through a mouse, a handheld controller (e.g. a joystick, game pad or keyboard arrow keys) a keyboard.

[0369] In another aspect of the present invention, an operator is able to exert manual control of all controlled air

vehicles and any associated on board cameras (e.g., gimbaled cameras) via a hand-held controller, which is illustratively similar to that utilized in the commercial computer gaming industry. In one embodiment, the controller includes two thumb-operated joysticks; one used for steering the selected vehicle, and the other for panning and tilting the camera. In one embodiment, the system is configured such that the operator can take manual control of any vehicle at any time in the mission, and can return to autonomous vehicle control as desired.

[0370] In another aspect of the present invention, the mouse control is configured to control a cursor on the GUI (e.g., the GUI illustrated in FIG. 26 and described below), for example through standard operator-initiated "point-and-click" operations, menu options and/or icons. In another embodiment, alphanumeric entries are inserted in the GUI with the keyboard as necessary. In another embodiment, the operator can be in voice communication with the flight line personnel throughout a mission with the two-way radio. It should be noted that any other similar input and output means (e.g., voice recognition input, etc.) can be implemented without departing from the scope of the present invention.

[0371] FIG. 26, in accordance with one aspect of the present invention, is a block diagram representation of an example GUI display 2622. In accordance with one embodiment, display 2622 is subdivided into several sub-components (e.g., sub-windows). These sub-components illustratively include a vehicle status display 2624, a vehicle parameter display 2626, a video display 2628, a mission situation display 2629, a vertical profile display 2631 and a selection pane 2630. In addition, display 2622 also includes pop-up dialogs 2630. An operator is able to view more information than that which is displayed in the four sub-components by accessing various pop-up dialogs 2630. For example, the operator can view details of vehicle parameters, data link parameter details, detailed management of video/IR sensor data and support information related to route editing. It should be noted that this is not an exhaustive list of information sets to which the operator is provided access.

[0372] In one aspect of the present invention, display 2622 incorporates at least one intelligent window display having smart variables included therein. The concept behind an intelligent window display is that a display will function whether or not underlying data is provided through a vehicle data link. The motivation for such a window is to allow different vehicles with different data link variables to use common windows for situational awareness. The intelligent window fills the displays with 'smart variables', allowing the display to be adaptive, and fills in data when it is available. When data is not available, then the corresponding data field will appear inactive or grayed out.

[0373] FIG. 27 illustrates one illustrative example of a combination vehicle status display 2624 and vehicle parameters display 2626. The display includes vehicle link parameters 2740 and caution, alerts and warnings (CAWS) pane 2742. Vehicle link parameters pane 2740 illustratively includes critical vehicle parameters such as engine RPM, fuel remaining in accordance with time and distance the vehicle can fly with the fuel remaining, altitude and data link parameters. The CAWS pane 2742 illustratively contains

active and/or inactive alerts to apprise the operator of system malfunctions. Examples include: return to base ranges, problems with the programmed route, vehicle performance problems and various other off-nominal conditions. The CAWS pane 2742 allows an operator to focus on imagery and mission level tasking with reduced attention to detailed information related to UAV state and health. With respect to vehicle status display 2624, the operator can view more detailed information or pop-up dialogs related to vehicle status by pointing and clicking on various push buttons such as “MORE” button 2744.

[0374] FIG. 28, in accordance with one aspect of the present invention, is an illustrative screen shot representation of an intelligent window display in the form of a pop-up dialog 2800 (e.g., as activated by pointing and clicking on the selectable “MORE” button 2744 in FIG. 27). The Route ID box 2802, the measured altitude box 2804, and the sensor roll angle box 2806 are displayed as inactive (i.e., are grayed out) while the rest of the display elements are actively updated with data. This is illustratively true because the route ID is not included in the corresponding vehicle’s data link. Similarly, the vehicle is illustratively not equipped with a radar altimeter for ground altitude. Finally, the sensor is illustratively gimballed in pitch and yaw only, so the concept of the gimbal roll angle does not make sense for this configuration. The intelligent window accesses the smart variables in the datalink download list. If the smart variable has not been set, the display simply displays the corresponding control box as inactive.

[0375] In accordance with one aspect of the present invention, the described GUI is configured such that the operator can access one or more control selection windows configured in a manner similar to the exemplary screen shots provided in FIGS. 29 through 32. FIGS. 29 through 32 together represent various components of a selections pane 2950 that supports a system of fully functional dynamic control and management such as can be utilized to manage and control multiple UAV’s, as well as corresponding UAV payloads. The GUI is illustratively configured such that the operator can select and access a selections panel 2950 for any vehicle under control. As illustrated in FIG. 29, the selections panel 2950 includes means for instigating and switching between various levels of manual and autonomous control for a corresponding vehicle (without departing from the scope of the present invention, a fully manual option, i.e., stick-and-rudder control, could also be presented as a “manual” control mode). When a manual control mode is selected (e.g., RDC or Sensor Slave), the operator illustratively assumes control authority of the corresponding vehicle individually from the ground control station, which can be done at any time in flight. When an autonomous mode is selected, the corresponding autonomous flight control scheme will be initiated. In some cases, upon selection of an autonomous control mode, the operator is presented with a screen for inserting parameters to which the operator desires the autonomous mode to conform (e.g., the operator can designate a point around which to loiter, etc.). FIG. 33 is one example of a pop-up window designed to collect operator parameters for a racetrack loiter pattern.

[0376] Other selectable features of the selections panel 2950 provide other control options such as auto maneuvers illustrated in FIG. 30, session options in FIG. 31 and an emergency abort option in FIG. 32 (e.g., from here the

automated landing process can illustratively be accessed for vehicle recovery). Selections pane 2950 illustratively provides additional functionality and details such as vehicle parameters, dynamic sensor control capability, a network connectivity ability to broadcast or transmit the UAV video data over LAN or WAN, critical GPS/INS performance parameters and a TM logging capability in association with the GCS notebook computer 2516 herd drive (FIG. 25).

[0377] With reference to FIG. 26, display 2622 also includes mission situational display 2629 as well as vertical profile display. The mission situational display 2629 illustratively provides the operator with real-time route information for one or more vehicles from a map perspective. In accordance with one embodiment, display 2629 supports real-time route editing. For example, in accordance with one embodiment, a toolbar is displayed across the top of the display and provides an operator-based rapid, intuitive point and click interaction for real-time mission planning and route editing capability, as well as map display editing features (e.g. zoom, center, change map background, etc.). In addition, in accordance with one embodiment, situation display 2629 includes a target editor (configured to tie a target to UAV mission objectives) and a corridor editor (configured to set no-fly zones and/or other mission planning boundary constraints).

[0378] The screen shot illustrated in FIG. 33, described in a different context previously, is also one example of a screen shot representation of an intelligent window display in the form of a pop-up dialog for route editing. The illustrated display provides the operator the capability to either type in known, precise waypoint coordinates or record graphically edited route event coordinates and parameters. This and similar pop-up functionality is illustratively provided through display 2622.

#### [0379] A. Synthetic Visualization Tools

[0380] In accordance with one aspect of the present invention, a combination of high fidelity synthetic visualization tools, faster than real time simulation technology, and variable autonomy control together provide a baseline architecture that is capable of supporting an enhanced level of real-time UAV control and situation awareness. In accordance with one embodiment, a synthetically enhanced situation awareness system (SESAS) supports real-time management and control of multiple UAVs by a single operator. The synthetic visualization display can include threat data realistically displayed over mapped and photo-realistic 3D terrain. These visuals are driven (dynamically propagated) by a combination of simulated and real UAV data. The simulated data is generated by the ground control station and propagated at a higher rate than real data is received from the air vehicle. When real data is received, it is used to correct the simulation solution, thus providing an accurate, continuous representation of the UAV flight state within its environment.

[0381] The described SESAS technology can be utilized to provide a wide field of view (FOV) that augments live video and sensor feeds while circumventing payload end bandwidth limitations. Specifically, correlated, photo-realistic 3D terrain can be presented on multiple monitors or flea panel displays to provide a wide area FOV to aid operators in orientation and situation awareness. Furthermore, in accordance with one embodiment, the photo-realistic representa-

tion of the scene can be viewed from various frames of reference (e.g., with the simple push of a button). For example, one view is an out-the-window (OTW) view that provides a forward-looking wide area view of the scene (this would represent a pilot's cockpit view, for example). Another view is from above and behind the UAV, providing an outside observer's frame of reference (illustratively including a representation of the vehicle). An additional view is a sensor view in which the live sensor FOV is synthetically increased.

[0382] Significant reductions in datalink bandwidth requirements can be achieved with the aid of the simulation. Background and high frequency update information is provided by the simulation, while low-frequency data specific to the UAV—data that changes in real time over long periods of time—is provided via downlinks. By filling in the high frequency gaps with simulated data, very low update rates over the datalink are made feasible in that the operator is provided with a continuous situation awareness that is comprised of mixed live and simulated data. In accordance with one embodiment, a simulated wide field of view from the perspective of an on-board sensor is optionally provided (e.g., synthetic data is utilized to expand the sensor view).

[0383] The realism afforded by the synthetic visuals significantly enhances the operator's situation awareness. The synthetic visuals illustratively offer multiple views (or frames of reference) and increased field-of-views over that of on-board sensors. In accordance with one embodiment, video display 2628 in FIG. 26 provides a synthetic visual yet photo-realistic, computer-generated image of the visual environment of a selected air vehicle (a selected one of several vehicles being controlled by an operator). In accordance with one embodiment, the global positioning system (GPS) and inertial navigation system (INS) data that correspond to a vehicle's current position provide an input to the synthetic visual display, along with the vehicle's flight parameters (e.g., bank angle, pitch angle, heading, and speed). In accordance with one embodiment, special effects, such as target features and explosions, can be programmed in the display.

[0384] Accordingly, one aspect of the present invention pertains to a display system and situation awareness technology that presents the operator with an at least partially virtual representation of the vehicle environment. This enables the operator to be immersed in the vehicle environment without requiring the expense and data link bandwidth requirements of extended image based sensor suites. This display technology can be utilized to orient operators of both manned and unmanned vehicles. For example, the synthetic display can enable a pilot onboard a vehicle to orient himself relative to actual terrain even when conditions, are dark, cloudy, foggy, etc.

[0385] In one embodiment of a synthetic display system in accordance with the present invention, a state-of-the-art PC Image Generation (PCIG) component is an incorporated component. Such a component is available from SDS International of Arlington, Virginia. The PCIG is integrated into the control interface of the present invention to facilitate synthetically enhanced operator situation awareness display. The resulting display is a real-time display of 2D and 3D images that can be configured to include threats, friendlies, and command control overlays. The visuals offer complete

and current sensor/decision, maker/shooter information, plus situation awareness for safety and navigation.

[0386] In one embodiment, synthetic visuals are driven by the vehicle in a manner very similar to a high fidelity flight simulator commanding ownship eye-point, environment and other entities. The chief difference being that instead of a high fidelity flight simulator, live vehicle state information drives the ownship eye-point. Furthermore, the other entities (ground-based threats, other aircraft, etc.) are illustratively real-world sensed entities as opposed to simulated entities.

[0387] In one embodiment of the synthetic visual display, the photo-realistic geo-specific visuals originally developed for training and mission rehearsal are directly utilized in an operational UAV context. In the simplest terms, the GPS and INS data that report UAV position are utilized as inputs to the Synthetic Visual Display's API, which couples the state data with FOV and orientation information from the cameras and sensors onboard the UAV. Replication of the simulated visuals provides "perfect weather", daylight visuals regardless of the night, weather, fog, clouds, or camera/sensor battle damage. The use of wider Field of View, multiple screens, augmented symbology and network integrated data exchange support an entire new generation of situation awareness enhancements, tools and operator decision aids, especially in the context of UAVs with their flexible ground control stations and network interconnectivity.

[0388] In one aspect of the present invention, synthetic vision display technical approach of the present invention is based upon integrating advanced simulated visuals, originally developed for training purposes, into UAV operational systems. In accordance with one embodiment, the simulated visuals are integrated with data derived from the ground control station during flight to enable real-time synthetic visuals.

#### [0389] B. GUI Component Selection

[0390] In one aspect of the present invention, through GUI display 2622, an operator can maintain a variable level of control over a UAV, from fully manual to fully autonomous, with simple user-friendly inputs. For example, if an operator decides to divert a UAV to a new route, the operator has a plurality of options to select from. The following are examples of some of the options that an operator has. Those skilled in the art should recognize that this is not an exhaustive list. In one embodiment, the operator could graphically edit the existing route on mission situation display 2629 by adding a waypoint or orbit pattern in the vicinity of a desired target region. Prior to accepting the edited route, the control system evaluates the revised route against the vehicle performance capability as well as terrain obstructions. If the route is within acceptable bounds, the control system registers the modified route and maneuvers the vehicle accordingly. In another embodiment, the operator could select a park mode on selections pane 2630. After selected, the control system queues the operator to click the location of and graphical size (via a mouse) the desired orbit pattern in which the vehicle will fly while "parked" over a desired target. In another embodiment, the operator can select a manual control mode on selections pane 2630. By selecting RDC (remote directional command), for example, the control system controls the UAV into a constant altitude, heading and speed flight until the operator instructs a maneuver. While in RDC mode, the operator can either

pseudo-manually direct the UAV using the control stick (e.g. joystick) or the operator can program a fixed heading, altitude and speed using the control options provided in selections pane 2630.

[0391] The described Intelligent displays with smart variables represent an effective approach to actively displaying information for different types of vehicles. However, a problem can arise when a new vehicle is integrated into the ground control station with a completely foreign command and control interface. Under these circumstances, the ground control station is not concerned about displaying data, but is tasked to provide a command and control interface for the operator to perform the required operations. This conundrum is the motivation for another embodiment of the present invention, namely, the integration of vehicle specific panels in the ground control station.

[0392] In one embodiment, a generic vehicle class (GVC) is illustratively a software component that provides a rapid development environment API to add new vehicle classes and types to the ground control station. The GVC also illustratively serves as a software construct that allows the inclusion of multiple vehicles within the ground control station framework. One of the variables in the application is a vector of pointers to a generic vehicle class. This list is constructed by allocating new specific vehicles and returning a type case to the base generic vehicle class. When a new vehicle is integrated into the ground control station, the generic vehicle class provides all of the virtual functions to integrate with system control components (e.g., to integrate with a map display, a communications package, PCIG imagery and/or appropriate display windows). An important object in the application framework is illustratively a pointer to the current vehicle generic class. When the user switches vehicles, this pointer is updated and all displays grab the appropriate smart variables from the pointer to the new base class. This is the mechanism by which windows immediately update to the current vehicle information whenever the user switches vehicles. The default windows use the pointer to the current vehicle to grab information. In this manner, if the user switches to a new vehicle with a different set of datalink variables, that fact is immediately apparent on the display windows.

[0393] FIG. 34 is a schematic block diagram demonstrating implementation of vehicle specific panels. Through base control station 3402, an operator has access to a plurality of vehicle classes labeled as 3404, 3414 and 3424 (others can be included as well). Each vehicle class illustratively contains a pointer to associated vehicle specific windows, along with virtual functions that can be asserted to provide an appropriate display. When a vehicle is selected, the appropriate vehicle specific information (i.e., windows 3406, 3408, 3410, 3412, etc.) will be displayed.

[0394] In one embodiment, a given vehicle can be configured to select default panels, in which case vehicle specific panels will not be provided for that particular vehicle class. In one embodiment, if a default window does not provide a particular functionality required by a new vehicle, a new vehicle specific class can override those base windows and the new windows will be displayed upon selection.

[0395] FIGS. 35 and 36 are screen shot representations demonstrating vehicle specific sensor control windows.

FIG. 35 is illustratively a vehicle specific control window for a vehicle identified as Dakota1. FIG. 36 is illustratively a vehicle specific control window for a vehicle identified as Dakota2. Whenever Dakota1 is selected as the active vehicle, the platform includes a steerable sensor with an optional IR digital camera. However, the Dakota2 variant has no steerable camera at all. Instead, it is equipped with a fixed camera and a Ground Collision Avoidance System. When the user selects Dakota2 as the active vehicle, the sensor control window switches to the vehicle specific sensor window. This window allows the user the option to turn on and off the ground collision avoidance system.

[0396] The described ability to tailor the ground control station windows enables any vehicle to be integrated with the ground control station without loss of information from the previously integrated vehicles. Accordingly, the ground control station supports a multi heterogeneous platform command and control application. One potential limitation on the number of selectable vehicles is the throughput of the collective datalink packages.

[0397] Referring back to mission situation display 2629 of FIG. 26, each vehicle is illustratively represented on the display (e.g., the map display) by a symbol (e.g., a representation of a vehicle). A vehicle symbol moves across the display, typically an illustrated map, in accordance with movement of the actual vehicle (e.g., movement relative to the map is to scale). The path of where a vehicle has been (and/or where the vehicle has been directed to go) is illustratively represented by a line. In one embodiment, each vehicle and its associated path lines are displayed in a unique color so as to distinguish one vehicle's activity from another. The interface is illustratively configured such that a user can click directly on the display and thereby select one of the vehicles causing vehicle specific control windows to be displayed for the selected vehicle. Once a vehicle is selected, the system is configured such that the user can change the mode of control for the selected vehicle. In the context of the VACS design described herein, the operator can select from the range of available variable autonomous control modes. In accordance with one embodiment, if the operator switches control to a second vehicle without leaving adequate prospective flight instructions for the first vehicle, then the first vehicle will "hold steady" (e.g., steady velocity, altitude, etc.) until direct control is resumed.

[0398] FIG. 37 is a screen shot representation of a detailed operator control graphical user interface display in accordance with an embodiment of the present invention. The display includes a mission situation display 3702 illustratively configured in a manner similar to the map display described in the preceding paragraph. Window 3704 is illustratively configured for operating data and function display. FIG. 37 is illustratively configured to display data and functions related to GPS and/or camera functionality. Window 3708 is illustratively a window configured to display data and functionality related to various system parameters. Window 3710 is illustratively configured to display data and functionality related to the navigation system. Finally, window 3712 is configured to display data and functionality related to control modes (e.g., operator can interact with this window to change control modes for a given vehicle). Displayed windows are illustratively configured for relocation and reconfiguration as desired by a particular operator. In one embodiment, the vehicle for

which displayed parameters are associated depends on which vehicle has been selected by the operator. Again, the map display can illustratively be configured to show all vehicles relative to one another (and relative to the map) regardless of which vehicle is selected.

**[0399]** In one aspect of the present invention, the dynamic information in the dialog windows and navigation map is updated as the flight progresses and as the flight parameters undergo change. The vehicle information that is displayed corresponds to the vehicle the operator selects (simply clicking on the appropriate vehicle icon in the map display), and any one of the vehicles currently in flight can be selected. The map display provides a photographic depiction of the mission site, the relative locations of the air vehicles at the site, and the planned routes of the vehicles. An image output synthetic or otherwise, can alternatively be portrayed on the map display (alternatively, sensor data and/or synthetic image data can be displayed on separate monitors). The vehicle icons and the navigation routes are illustratively color-coded and highlighted on the map display as the vehicles are individually selected. Route planning can be performed from the map display, and route editing (e.g., changing waypoint locations) can be accomplished at any time in a mission. The map display also provides a depiction of the imaging payload field of view and the terrain area encompassed within it. The location and types of targets in the flight environment can also be represented on the map display. A profile view showing the height of the operator-selected vehicle above to the terrain can be displayed below the map. Various drop-down menus are also available to the operator from the GUI.

**[0400]** In one embodiment, for vehicles that incorporate a visual sensor (e.g., a digital camera), the vehicle indicated on the map display includes a sensor window indication displayed proximate to the vehicle indication (e.g., a box located in front of the vehicle indication). The dimensions of the sensor window indication illustratively corresponds to a field of view for the camera as it is displayed on a monitor in a control station. If the operator guides the vehicle or camera so as to open up a broader field of view, then the box indication illustratively becomes larger. Conversely, if the operator guides the vehicle or camera so as to narrow the field of view, then the box indication illustratively becomes smaller.

**[0401]** In review, a VACS human-system interface (HSI) is implemented with a graphical user interface (GUI) that allows the operator to quickly alter the UAV course with little effort. The VACS HSI focuses on the UAV mission tasking rather than vehicle aviation; hence, the VACS interface places minimal significance on standard “cockpit” displays and focuses on situation displays. The operator interacts with VACS through the use of a mouse, a joystick (or game pad), and/or a keyboard. The software can easily be modified to take advantage of touch-screen capabilities as well.

**[0402]** In accordance with one embodiment, a ground control station display is divided into 4 subcomponents: a vehicle status display, a situation display, a video display, and a selection pane. This interface contains a route editing dialog to support real-time route editing as well as a variety of selection panes to support fully functional dynamic control and management of the UAV.

**[0403]** In accordance with one embodiment, push buttons in the main GUI provide access to additional dialogs that provide vehicle status information, sensor management and control functionality, and information dissemination capability through both data logging and network connectivity. A route editing dialog is accessed from the map display and provides the operator rapid, intuitive point-n-click system interaction for real-time mission planning and route editing capability, as well as map display editing features (zoom, center, change map background, etc). The route editing pop-up dialog provides the operator the capability to either type in known, precise waypoint coordinates or record graphically edited route event coordinates and parameters. The situation (map) display also contains a target editor with the capability to tie targets to UAV mission objectives and a corridor editor set no-fly zones and/or other mission planning boundary constraints.

**[0404]** In accordance with one embodiment, mission/route editing is performed manually by the operator, using the graphical user interface “point-n-click” functionality on the map or typing in the coordinates. The interface, however, is illustratively designed generically so automated route plans can be accepted. VACS contains automatic route/mission analysis tools to alert the operator if a planned mission is not physically realizable due to vehicle performance constraints or terrain collision issues.

**[0405]** In accordance with one embodiment, the VACS GCS also contains a Cautions, Alerts, and Warnings (CAWS) panel that alerts the operator to system malfunctions, low fuel, route errors, and various other off-nominal conditions. The CAWS display will alert the operator when a vehicle subsystem fault is detected.

**[0406]** Using the VACS GUI interface, the operator can maintain any level of control over the UAV, from fully manual to fully autonomous, with the simple click of a mouse. For example, if the UAV is flying a preprogrammed waypoint route and the operator decides to divert it from that route to a new desired location, he/she has a myriad of options at his disposal. For example, a few of the options are:

**[0407]** 1. Graphically edit the existing route on the mission situation display by adding a waypoint or orbit pattern in the vicinity of the desired target region. Prior to accepting the edited route, VACS evaluates the revised route against the vehicle performance capability as well as terrain obstructions. If the route is within acceptable performance bounds, VACS then registers the modified route into the outer-loop control function and the vehicle maneuvers accordingly.

**[0408]** 2. Select “Go To” point on the 2D situation map display. When this mode is selected, VACS will queue the operator to click the location of and graphically size (via the mouse) the desired orbit pattern, which the vehicle is to fly while “parked” over a target area.

**[0409]** 3. Select a manual control mode on the vehicle selections panel. By selecting RDR (remote directional response), for example, VACS controls the UAV into a constant altitude, constant heading, and constant speed flight condition until the operator instructs a maneuver. While in RDR mode, the operator can either:

**[0410]** a. Pseudo-manually direct the UAV using the control stick (horizontal stick commands map to horizontal turn rates, vertical stick commands map to vertical climb/descent rates).

[0411] b. Program in a fixed heading, altitude, and speed using the control options provided in the route tab of the selection pane.

[0412] XII. Datalink

[0413] In one aspect of the present invention, in order to facilitate simplified multi-vehicle communications, the ground control station implements a UDP/IP (user datagram protocol/internet protocol) standard. This configuration enables the underlying operating system to organize and multiplex data based on IP addresses. In one embodiment, the generic vehicle class system provides a means for assigning a vehicle IP address. When all system IP addresses are known, each vehicle provides its data link messages and the ground control station forwards those messages to the appropriate Internet address. In one embodiment, this type of data collection is used primarily for uplink information.

[0414] One aspect of the present invention pertains to the parsing of downlink messages. One embodiment pertains to an implementation of the known serial line Internet protocol (SLIP). The SLIP protocol takes standard IP type information and encodes it to a serial stream to be sent over a serial device. On the other side, a decoder converts the serial stream back to IP so the computers on each side of the interface do not know about the underlying serial protocol—to them, communication is consistent with IP over Ethernet links.

[0415] In accordance with one embodiment of the present invention, the ground control station actually connects to a router (e.g., a SLIP router), which takes all of the information from the ground control station and forwards it to the appropriate vehicle. In accordance with one embodiment, this enables a user of hybrid hardware systems with 802.11b amplified cards or serial communication radios (e.g., Freewave radios) which run the SLIP protocol to mask the underlying serial interface. With this setup, the ground control station always connects to vehicles as if they were computers on a network, and all routing is taken care of by the router. Thus, data packets going over serial communication radio interfaces (e.g., Freewave radio interfaces) are run through the SLIP protocol and data packages going over 802.11b amplified cards are forwarded without processing. It should be noted that a SLIP router and SLIP protocol are provided as examples of a suitable implementation. Other similar known communications implementations could be incorporated without departing from the scope of the present invention.

[0416] The reading of download data links becomes a bit complex. The reason is that the ground control station always talks to the SLIP box, so information from any vehicle is effectively coming from the same Internet address. Therefore, in accordance with one embodiment, the ground control station monitors a specific designated port for all incoming data. The data has an assumed header that contains a vehicle ID and message size. The communications package then forwards the datalink information to the appropriate vehicle class.

[0417] FIG. 38 is a schematic block diagram demonstrating a network centric UDP communications scheme in accordance with one embodiment of the present invention. Vehicles 3804, 3806, 3808 and 3810 each include an illustrated IP address and communicate with ground control

station 3812 by way of router (e.g., SLIP protocol means) 3802. Station 3812 also includes an illustrated IP address. It should be noted that other components can be assigned IP addresses and added to the communications loop. For example, within FIG. 38, a visual system 3814 is illustrated and includes an illustrated IP address for communications support.

[0418] Accordingly, one aspect of the present invention pertains to a spread-spectrum communications hardware architecture and supporting multi-layered communications software packages that enable multi-vehicle IP-based messaging (TCP, UDP). This IP-based messaging design enables multi-vehicle control using either conventional radios driven by serial interfaces or wireless Ethernet boards (i.e., 802.11).

[0419] One advantage of the described multi-vehicle communications architecture is compatibility with conventional spread-spectrum data link systems that operate with standard serial interfaces. An Ethernet-to-transceiver bridge provides a transparent IP (TCP or UDP) network interface for the Ground Control Station (GCS) to interface to multiple UAVs. In accordance with one embodiment, to utilize wireless Ethernet (i.e., 802.11) technology, the bridge and spread-spectrum radios are simply replaced with the 802.11 board—no software modifications are required.

[0420] XIII. Flight Control System Hardware

[0421] In accordance with one aspect of the present invention, the VACS architecture is applied in the context of an integrated UAV digital flight control system and ground control system. In accordance with one embodiment, the airborne digital flight control system is implemented in the context of a computing environment (e.g., a PC/104 stack) configured for guidance, navigation, and control processing, power distribution, I/O handling, and/or a data link system. Depending on a given application and implementation, the computing environment can also be configured to support an inertial measurement unit (IMU), a precision pressure transducer for airspeed measurements, a GPS receiver, and/or a control interface to a pan-tilt-zoom or gimbaled payload system. An interface controller box can also be provided to allow the UAV to be operated by either the VACS controller or a back-up radio control (R/C) transmitter. As has been described, the airborne system guidance and autopilot software is capable of supporting varying levels of control autonomy.

[0422] XIV. Sample Mission

[0423] The described VACS architecture and user interface control system enables an example mission as follows. In the example scenario, three UAV's are simultaneously controlled by a single operator from a ground control station. The operator controls the vehicles during a simulated target search and destroy mission. Two of the vehicles image a ground "target", using on-board digital cameras, and one of the vehicles performs a simulated target attack maneuver. Each vehicle provides various autonomous flight control capabilities to the operator, including autonomous waypoint navigation, various orbit patterns for time-on-target, loss-of-link and return-to-base (automatic landing initiated to preprogrammed or operator-designated location when communications link lost), and automatic ground collision avoidance.



[0424] In accordance with the example mission, three air vehicles are flown simultaneously, simulating a target search and destroy mission. The vehicles are launched individually under the control of an R/C pilot, who is located near the takeoff point on an airfield runway. The pilot remotely steers each of the vehicles to a transition point, where vehicle control is switched over to the GCS operator. Following the switchover, the operator manually steers the vehicle toward a pre-planned orbit pattern. After the vehicle is properly oriented, the operator commands the VACS control system and the vehicle flies autonomously to the orbit pattern. The vehicles all orbit at an altitude of 1500-ft. MSL (~1000-ft. AGL) and at a speed of approximately 75 kts.

[0425] One of the vehicles illustratively circles near the end of the runway and briefly images the runway as it circles. An automobile, representing a ground target, is positioned on the runway. The air vehicle is then commanded to a lower altitude in the orbit pattern to simulate a target surveillance maneuver. The vehicle is then commanded to climb to its original orbiting altitude.

[0426] Next, the operator redirects one of the vehicles and sends it from its orbit pattern to the runway by designating a target location on the situation display and invoking a "go to" mode. The UAV autonomously captures and enters an orbit pattern over the target and automatically steers the camera to maintain persistent surveillance of the target. Subsequently, the vehicle autonomously returns to the orbit pattern.

[0427] The operator then decouples the VACS automation on another vehicle and programs a new route to pass over the runway. Near the runway the vehicle is sent to a lower altitude to simulate a weapon attack. After several passes over the runway, the vehicle is returned to its initial altitude and the vehicle autonomously returns to its pre-assigned orbit pattern.

[0428] Vehicle speeds are always maintained at about 75 kts. The autonomous landing system of the present invention is engaged to return the vehicles to the runway from which they took off. An automated take-off can illustratively also be implemented to eliminate the necessity of an RC controller for landing/take-off.

[0429] FIG. 39 is a schematic block diagram illustrating potential control paths through a mission in accordance with the VACS architecture. Block 3902 represents the potential missions that can be executed such as surveillance, reconnaissance and/or target acquisition. Of course, other missions, including non-military related missions, are within the scope of the present invention. Block 3904 represents the step of planning a mission. Block 3906 represents launching a vehicle. Block 3908 represents monitoring system status after launch. Block 3910 represents evaluating whether a critical system failure has occurred. If such a failure does occur, then the mission is aborted in accordance with block 3912 (e.g., the vehicle is recovered in accordance with an automated landing process execution). Such monitoring is executed in a loop to continually watch for critical failures.

[0430] In accordance with block 3914, reconnaissance data is gathered if necessary. Block 3916 represents vehicle mission management. In accordance with block 3918, communication links are monitored. If a communication link is interrupted, then link loss procedures are implemented in

accordance with block 3920 (e.g., automatic landing system is initiated for vehicle recovery). In accordance with block 3922, the operator manages the route the vehicle is set to follow. In accordance with block 3928, the operator can edit the route. If a non-valid route is entered, then the route must be edited again. Otherwise, the valid route is executed. This is but one means of control available to the operator for mission execution.

[0431] In accordance with block 3926, the operator manages sensors associated with the vehicle. Block 3934 indicates selection of a sensor. In accordance with block 3936, a sensor control mode can be set. One of the sensor control mode settings available corresponds to block 3944 and is an auto-tracking functionality wherein the sensor will automatically track as necessary. Block 3946 represents a manual control of the sensor and block 3948 represents steering of the sensor. Block 3950 represents sensor control based on a designated target.

[0432] Block 3924 represents control mode management by the operator. In accordance with block 3930, the operator can choose an autonomous control mode such as, but not limited to, vehicle route management. In accordance with block 3932, the operator can select a manual control mode. In accordance with block 3938, the operator can choose RDR control. In accordance with block 3952, the vehicle can be steered in the horizontal and vertical planes. These modes can be executed as necessary to support achievement of mission objectives in accordance with block 3962.

[0433] Another available mode of control is line-of-sight-slave control in accordance with block 3940. In accordance with block 3954 the vehicle sensor is utilized for steering purposes as necessary to support achievement of mission objectives. Block 3942 represents program maneuver control. Block 3956, 3960 and 3958 represent a setting of parameters for programmed maneuver control. The program maneuver control can also be selected to support the achievement of mission objectives. In accordance with block 3962, analysis is conducted to determine whether mission objectives have been achieved. If they have not, then the control processes are continued. If the objectives have been achieved, then, in accordance with block 3964 and 3966, the vehicle is recovered (e.g., automated landing system is implemented if necessary). In accordance with one embodiment, radio control is utilized to launch and/or recover a vehicle.

[0434] Although the present invention has been described with reference to preferred embodiments, workers skilled in the art will recognize that changes may be made in form and detail without departing from the spirit and scope of the invention.

What is claimed is:

1. A computer-implemented method for providing an operator of a vehicle with a plurality of control modes, wherein the system is configured to support transitioning between control modes during operation of the vehicle, the method comprising:

receiving a first operator input that corresponds to a first control mode;

generating a first directional representation of the first operator input;

processing the first directional representation through a unified autopilot system so as to generate a first control output;

mechanically adjusting a control component associated with the vehicle based on the first control output;

receiving a second operator input that corresponds to a request to transition from the first control mode to a second control mode;

transitioning from the first control mode to the second control mode;

receiving a third operator input that corresponds to the second control mode;

generating a second directional representation of the third operator input;

processing the second directional representation through the unified autopilot system so as to generate a second control output; and

mechanically adjusting a control component associated with the vehicle based on the second control output.

**2.** The method of claim 1, wherein said transitioning comprises processing a transition command through the unified autopilot system.

**3.** The method of claim 1, wherein generating a first directional representation comprises generating a first set of acceleration and bank angle commands.

**4.** The method of claim 1, wherein transitioning from the first control mode comprises transitioning from a first control mode wherein the vehicle is controlled based on manipulations by the operator of an image sensor that is located onboard the vehicle.

**5.** The method of claim 1, wherein transitioning from the first control mode comprises transitioning from a line-of-sight-slave mode of operation.

**6.** The method of claim 1, wherein transitioning from the first control mode comprises transitioning from a remote directional control mode of operation.

**7.** The method of claim 1, wherein transitioning from the first control mode comprises transitioning from a ground collision avoidance mode of operation.

**8.** The method of claim 1, wherein said processing through a unified autopilot system comprises processing through an acceleration-based autopilot system.

**9.** The method of claim 1, wherein said processing the first and second directional representations through a unified autopilot system comprises adjusting for disturbance rejection.

**10.** The method of claim 1, further comprising processing the first and second directional representations to adjust for route following accuracy.

**11.** The method of claim 1, wherein transitioning from the first control mode to the second control mode comprises transitioning from a first mode offering a first level of system autonomy to a second mode offering a different level of system autonomy.

**12.** A multi-modal variable autonomy control system configured to support transitioning between control modes during operation of a vehicle, the system comprising:

a first control mode component configured to respond to a first user input by generating a first control mode command;

a second control mode component configured to respond to a second user input by generating a second control mode command;

a control mode selection component for responding to an operator control mode selection input by transitioning between a first mode of control that corresponds to the first control mode component and a second mode of control that corresponds to the second control mode component; and

a unified autopilot system for processing the first or second control mode - commands depending on which of the first and second modes of control has been selected.

**13.** The system of claim 12, further comprising a translation layer for translating the first or second control mode commands into a format appropriate for the unified autopilot system.

**14.** The system of claim 12, wherein:

the first control mode component is further configured to generate a first control mode command in the form of a directional command representation; and

the second control mode component is further configured to generate a second control mode command in the form of a second directional command representation.

**15.** The system of claim 12, wherein:

the first control mode component is further configured to generate a first control mode command in the form of acceleration and bank angle commands; and

the second control mode component is further configured to generate a second control mode command in the form of acceleration and bank angle commands.

**16.** The system of claim 12, wherein the unified autopilot system is an acceleration-based autopilot system.

**17.** The system of claim 12, wherein said first user input corresponds to a manipulation of an image sensor located on-board the vehicle.

**18.** The system of claim 12, wherein said first user input corresponds to an input originating from a multi-directional input mechanism.

**19.** The system of claim 18, wherein said first user input corresponds to an input originating from a multi-directional input mechanism that is part of a game pad input device.

**20.** The system of claim 12, wherein the first control mode component is configured to support a remote directional response mode of control.

**21.** The system of claim 12, wherein the first control mode component is configured to support a line-of-sight-slave mode of control.

**22.** The system of claim 12, wherein the first control mode component is configured to support a ground collision avoidance mode of control.

**23.** The system of claim 12, wherein the first control mode component is configured to support an autonomous route following mode of control.

**24.** The system of claim 12, wherein the first control mode component is configured to support loiter pattern modes of control.

**25.** The system of claim 24, wherein the first control mode component is configured to support an oval-based loiter pattern mode of control.

26. The system of claim 24, wherein the first control mode component is configured to support a figure-8 loiter pattern mode of control.

27. The system of claim 24, wherein the first control mode component is configured to support an racetrack-shaped loiter pattern mode of control.

28. The system of claim 12, wherein the first control mode component is configured to support a programmed maneuvers mode of control.

29. The system of claim 12, further comprising an intelligence synthesizer layer configured to resolve functional conflicts between the first and second modes of control.

30. The system of claim 12, further comprising an intelligence synthesizer layer configured to provide commands to the unified autopilot system as necessary to support transition between the first and second modes of control.

31. A multi-modal variable autonomy control system, the system comprising:

- a plurality of control mode components each corresponding to a different mode of control and being configured to respond to command inputs by generating directionally descriptive control commands; and

a unified autopilot component for processing said directionally descriptive control commands.

an vehicle control component for receiving processed commands from the unified autopilot system and actuating control devices accordingly.

32. The system of claim 31, wherein said plurality of control mode components are associated with more than three different modes of control.

33. The system of claim 31, wherein said plurality of control mode components are associated with both autonomous and user-input-based modes of control.

34. The system of claim 31, wherein said plurality of control modes are further configured to respond to command inputs by generating control commands in the form of acceleration and bank angle commands.

35. The system of claim 31, wherein the unified autopilot component is an acceleration-based autopilot component.

\* \* \* \* \*

# Exhibit 5

# Exhibit 5

1  
2  
3  
4  
5  
6  
7  
8  
9  
10  
11  
12  
13  
14  
15  
16  
17  
18  
19  
20  
21  
22  
23  
24  
25  
26  
27  
28  
29  
30  
31  
32  
33

**IN THE UNITED STATES PATENT AND TRADEMARK OFFICE**

In re Application of Jed Margolin

Serial No.: 11/736,356

Examiner: Ronnie M. Mancho

Filed: 04/17/2007

Art Unit: 3664

For: SYSTEM AND METHOD FOR SAFELY FLYING UNMANNED AERIAL VEHICLES  
IN CIVILIAN AIRSPACE

Mail Stop Amendment  
Commissioner for Patents  
P.O. Box 1450  
Alexandria, VA 22313-1450

**RESPONSE**

Dear Sir:

In response to the Office Action mailed September 1, 2010, please consider the following remarks.

**Section 1. General Summary**

Claims 1 - 14 were rejected solely under 35 U.S.C. §103(a) as being obvious by combining U.S. Patent 5,904,724 (“Margolin ‘724”) and published Patent Application US 2005004723 (“Duggan”). Applicant will show that the Examiner has failed his burden of establishing a *prima facie* case of obviousness.

- a.** The Examiner has failed to distinctly point out where all of the claim elements and limitations of Applicant’s claims are present in the two cited references.

1 **b.** The Examiner has mischaracterized the two cited references as teaching all of the claim  
2 elements and limitations of Applicant's claims, when they do not.

3 **c.** The present Applicant is the named inventor on one of the Examiner's cited references  
4 (U.S. Patent 5,904,724).

5  
6 **Section 2 - Detailed Response**

7  
8 **Part A - Examiner's Detailed Action Paragraph 2**

9  
10 **2. *Claims 1-14 are rejected under 35 U.S.C. 103(a) as being unpatentable over Margolin***  
11 ***(5904724) in view of Duggan et al (US 2005004723).***

12  
Regarding claim 1, Margolin (abstract; figs. 1-7; col. 3, lines 8-67; col. 4, lines 1-67; col. 5, lines 1-67) discloses a system for safely flying an unmanned aerial vehicle in civilian airspace comprising:

(a) a ground station 400 (fig. 1 & 4) equipped with a synthetic vision system (figs. 1 & 3; col. 4, lines 1 to col. 5, lines 67);

(b) an unmanned aerial vehicle 300 (figs. 1 & 3) capable of supporting said synthetic vision system (305, 306, 307, 311 on aircraft; col. 3, lines 8-67; col. 4, lines 1-67; col. 5, lines 1-67);

(c) a remote pilot 102 operating said ground station 400 (figs. 1&4; col. 3, lines 8-67; col. 4, lines 1-67; col. 5, lines 1-67);

(d) a communications link between said unmanned aerial vehicle 300 and said ground station 400;

(e) a system onboard said unmanned aerial vehicle 300 for detecting the presence and position of nearby aircraft (305, 306, 307, 311 on aircraft) and communicating this information to said remote pilot 102 (col. 3, lines 8-67; col. 4, lines 1-67; col. 5, lines 1-67);

whereas said remote pilot uses said synthetic vision system (305, 306, 307, 311 on aircraft) to control said unmanned aerial vehicle 300 during at least selected phases of the flight of said unmanned aerial vehicle.

1 Applicant Responds.

2 MPEP § 2142 states under the heading **ESTABLISHING A PRIMA FACIE CASE OF**  
3 **OBVIOUSNESS**

a. **\*\*>The key to supporting any rejection under 35 U.S.C. 103 is the clear articulation of the reason(s) why the claimed invention would have been obvious.** The Supreme Court in *KSR International Co. v. Teleflex Inc.*, 550 U.S. \_\_\_, \_\_\_, 82 USPQ2d 1385, 1396 (2007) noted that the analysis supporting a rejection under 35 U.S.C. 103 should be **made explicit**. The Federal Circuit has stated that "**rejections on obviousness cannot be sustained with mere conclusory statements; instead, there must be some articulated reasoning with some rational underpinning to support the legal conclusion of obviousness.**" In *re Kahn*, 441 F.3d 977, 988, 78 USPQ2d 1329, 1336 (Fed. Cir. 2006). See also *KSR*, 550 U.S. at \_\_\_, 82 USPQ2d at 1396 (quoting Federal Circuit statement with approval). <

4  
5 {Emphasis added}

6  
7 The Examiner has cited lengthy passages in the above rejection and made conclusory statements as  
8 to their contents.

9  
10 **Examiner:**

11 Regarding claim 1, Margolin (abstract; figs. 1-7; col. 3, lines 8-67; col. 4, lines 1-67; col. 5,  
12 lines 1-67) discloses a system for safely flying an unmanned aerial vehicle in civilian airspace  
13 comprising:

14  
15 **Applicant:**

16 In Margolin '724: Column 3, lines 8-67; Column 4, lines 1-67; and Column 5, lines 1-67 form a  
17 continuous passage from Column 3, line 8 to Column 5, line 67. This passage of approximately  
18 1619 words forms the core of the Margolin '724 DETAILED DESCRIPTION. The remainder of the  
19 Margolin '724 DETAILED DESCRIPTION teaches additional topics such as **Flight Control** (with  
20 headings *Flight Control*, *Direct Control Non-Remotely Piloted Vehicles*, *Computer Mediated Non-*  
21 *Remotely Piloted Vehicles*, *Second Order Flight Control Mode*, *First Order Flight Control Mode*

1 { See Column 6, line 19 - Column 8, line 3 }, the features of a Control Panel (See Column 8, line 64  
2 - Column 9, line 18), the use of a Head-Mounted Display { See Column 9, lines 19 - 32 }, the use of  
3 the invention for training { See Column 9, lines 33 - 63 }, and **The Database** { See Column 9, line 64  
4 - Column 10, line 50. }

5

6 The Examiner cites Figures 1 - 7 in Margolin '724. These constitute all the figures in Margolin  
7 '724.

8

9 The Examiner also cites the Abstract in Margolin '724. According to **608.01(b) Abstract of the**  
10 **Disclosure [R-7]:**

11 **37 CFR 1.72 Title and abstract.**

12 \*\*\*\*\*

13 (b) A brief abstract of the technical disclosure in the specification must commence on a  
14 separate sheet, preferably following the claims, under the heading "Abstract" or "Abstract of  
15 the Disclosure." The sheet or sheets presenting the abstract may not include other parts of the  
16 application or other material. The abstract in an application filed under 35 U.S.C. 111 may not  
17 exceed 150 words in length. The purpose of the abstract is to enable the United States Patent  
18 and Trademark Office and the public generally to determine quickly from a cursory inspection  
19 the nature and gist of the technical disclosure.<

20

21 {Emphasis added}

22

23 The popular interpretation of 608.01(b) is that the purpose of the Abstract is to provide search  
24 terms. In any event, the Abstract in Margolin '724 does not say anything about civilian airspace.

25

26 The Examiner has made a conclusory statement by repeating the title of Applicant's invention  
27 (leaving out the words "and method") and citing the core of the DETAILED DESCRIPTION in  
28 Margolin '724.

29

30 In the remaining sections of the Examiner's rejection of Applicant's Claim 1 he asserts that he has  
31 found all of the elements and limitations of Applicant's invention.

32



1 It is not surprising that some of the elements of Applicant's invention are present in Margolin '724  
2 since Margolin '724 is probably the pioneering patent for the use of what is now called *synthetic*  
3 *vision* in remotely piloted aircraft (now commonly called Unmanned Aerial Vehicles) and  
4 Applicant's present invention uses synthetic vision as an element.

5  
6 However, there are limitations in Applicant's current invention that are not present in Margolin  
7 '724.

8

9 **Examiner:**

10

11 whereas said remote pilot uses said synthetic vision system (305, 306, 307, 311 on aircraft) to  
12 control said unmanned aerial vehicle 300 during at least selected phases of the flight of said  
13 unmanned aerial vehicle.

14

15 {From Applicant's Claim 1 }

16

17 References 305, 306, 307, 311, and 300 come from Margolin '724 Figure 3 which shows the  
18 structural elements in Margolin '724 Remote Aircraft Unit 300. There is nothing in these structural  
19 elements which show that synthetic vision is used "during at least selected phases of the flight of  
20 said unmanned aerial vehicle."

21

22 The Examiner has not shown that this limitation is taught in Margolin '724. He has only made a  
23 conclusory statement.

24

25 Although *KSR* may have loosened the required reasoning that may be employed for combining prior  
26 art references in an obviousness rejection, the Examiner must still provide a factual basis for each of  
27 the claimed features of a rejected claim. MPEP 2143.03 entitled "**All Claim Limitations must be**  
28 **Considered**" states: "all words in a claim must be considered in judging the patentability of that  
29 claim against the prior art." *In re Wilson*, 424 F.2d 1382, 1385, 165 USPQ 494, 496 (CCPA 1970)."

30 If an examiner fails to address all of the recitations of a rejected claim, a *prima facie* case of  
31 obviousness has not been established because such a deficiency fails to satisfy the evidentiary  
32 requirements articulated by the Supreme Court in *KSR* (e.g. "the key to supporting any rejection

1 under 35 U.S.C. 103 is the clear articulation of the reason(s) why the claimed invention would have  
2 been obvious” and that “a rejection under 35 U.S.C. 103 should be made explicit.”)

3 The BPAI in a recent decision (*Ex parte Wehling et al.*) stated (with emphases added):  
4 “the dispositive issue in this case is **whether the Examiner has explicitly articulated a prima**  
5 **facie case of obviousness which addresses all of the limitations of the claimed invention.**” The  
6 BPAI was guided by the following legal principles:

7 “When determining whether a claim is obvious, an Examiner must make ‘a searching comparison of  
8 the claimed invention – including all its limitations – with the teachings of the prior art.’ *In re*  
9 *Ochiai*, 71 F.3d 1565, 1572 (Fed. Cir. 1995) (emphasis added). Thus, ‘obviousness requires a  
10 suggestion of all limitations in a claim.’ *CFMT, Inc. v. Yieldup Int’l. Corp.*, 349 F.3d 1333, 1342  
11 (Fed. Cir. 2003) (citing *In re Royka*, 490 F.2d 981, 985 (CCPA 1974)). Furthermore, in *KSR Int’l*  
12 *Co. v. Teleflex Inc.*, 550 U.S. 398, 418 (2007) (citing *In re Kahn*, 441 F.3d 977, 988 (Fed. Cir.  
13 2006), the Supreme Court noted that “[t]o facilitate review, this [obviousness] analysis should  
14 be made explicit.” (*Ex parte Wehling et al.*, Appeal No. 2009-8111 (BPAI))

15 The BPAI in *Ex Parte Wehling et al.* held that “absent a fact-based analysis which explicitly  
16 compares all the limitations of the claimed invention with the combined teachings of Gioffre and  
17 Rockliffe, we are constrained to reverse the rejection of claims 1, 21, 29, and 31 and the claims  
18 dependent thereon under § 103 over the combined teachings of Gioffre and Rockliffe.”

19 Note that *Ex Parte Wehling et al.* (Appeal 2009-008111, Application 10/743,118) was decided May  
20 17, 2010. According to the BPAI online database the decision was issued 10/19/2010 which is after  
21 the mail date of the Examiner’s rejection (9/1/2010).

22  
23 **Examiner’s Detailed Action Paragraph 2 (Continued)**

24

25 The Examiner continues

26

27 *Margolin did not disclose that the vehicle is flown using an autonomous control system.*

28 *However, Duggan teach of a system for safely flying an unmanned aerial vehicle in civilian*  
29 *airspace comprising:*

30 *a ground station controlling an unmanned aerial vehicle (sec. 0352, 00353), wherein*

1 *during phases of a flight of an unmanned aerial vehicle (UAV, sec 0318, 0322, 0353) when a*  
 2 *synthetic vision (sec. 0356, 0365, 0388, 0390) is not used to control said unmanned aerial*  
 3 *vehicle said unmanned aerial vehicle is flown using an autonomous control system (autopilot,*  
 4 *sec 0346 to 0350, 0390-0329).*

5 *Therefore, it would have been obvious to one of ordinary skill in the art at the time the*  
 6 *invention was made to modify Margolin as taught by Duggan for the purpose of incorporating*  
 7 *an autopilot to ensure smooth transitions (Duggna abstract, sec 0014, 0085, 0086).*

8 *The different embodiments in both prior arts are combinable as it would be obvious to*  
 9 *ne[sic] having ordinary skill in the art.*

10

11 (Applicant assumes Examiner meant to say, “*The different embodiments in both prior arts are*  
 12 *combinable as it would be obvious to one having ordinary skill in the art.*)

13

14 The Examiner has mischaracterized Duggan.

15

<u>Examiner</u>	<u>Duggan</u>
<p>Margolin did not disclose that the vehicle is flown using an autonomous control system. However, Duggan teach of a system for safely flying an unmanned aerial vehicle in civilian airspace comprising: a ground station controlling an unmanned aerial vehicle (sec. 0352, 00353),</p>	<p>[0352] In one aspect of the present invention, an operator station (also referred to as the ground control station or GCS) is designed to accommodate command and control of multiple vehicles or a single vehicle by a single operator. In accordance with one embodiment, the ground control station is platform independent and implements an application program interface that provides windowing and communications interfaces (e.g., the platform is implemented in Open Source wxWindows API). The underlying operating system is illustratively masked and enables a developer to code in a high level environment.</p> <p>[0353] In one embodiment, the ground control station incorporates several specialized user interface concepts</p>

<p>wherein during phases of a flight of an unmanned aerial vehicle (UAV, sec 0318,</p> <p>0322,</p>	<p>designed to effectively support a single operator tasked to control multiple vehicles. The GCS also illustratively supports manual control and sensor steering modes. In the manual control mode, the operator can assume control authority of the vehicles individually from the ground control station at any time in flight. In the sensor steering mode, a vehicle will autonomously fly in the direction the operator is manually pointing the on-board imaging sensor (e.g., operator views video output from a digital camera on a TV interface, computer screen display, etc.). A custom data link is illustratively, utilized to support a two-way transfer of data between the ground control station and the UAV's. These design concepts together provide a flexible, multiple vehicle control system. The details of the concepts are discussed below.</p> <p>[0318] If the pilot chooses a surveillance location outside the total FOV, then the outer loop guidance will illustratively follow a command-to-LOS mode guide law until the UAV flight path points toward the target. Once the desired staring-point comes within a minimum range threshold, the guidance automatically trips into a loiter pattern (either constant-radius or elliptical) to maintain a station with a single key-click while he/she conducts other activities. FIGS. 22A &amp; 22B together demonstrate the surveillance-point approach scenario.</p> <p>[0322] In accordance with one aspect of the present invention, sensor-slave mode commands are generated by an autonomous line-of-sight driven function, in which the command objectives are generated by the necessities of the function rather than by an operator. For example, a function</p>
---	--

	<p>designed to command a raster-scan of a particular surveillance area, or a function designed to scan a long a roadway could be used to generate sensor slave commands. Another example is a function designed to generate line-of-sight commands for UAV-to-UAV rendezvous formation flying.</p>
0353)	<p>[0353] In one embodiment, the ground control station incorporates several specialized user interface concepts designed to effectively support a single operator tasked to control multiple vehicles. The GCS also illustratively supports manual control and sensor steering modes. In the manual control mode, the operator can assume control authority of the vehicles individually from the ground control station at any time in flight. In the sensor steering mode, a vehicle will autonomously fly in the direction the operator is manually pointing the on-board imaging sensor (e.g., operator views video output from a digital camera on a TV interface, computer screen display, etc.). A custom data link is illustratively, utilized to support a two-way transfer of data between the ground control station and the UAV's. These design concepts together provide a flexible, multiple vehicle control system. The details of the concepts are discussed below.</p>
when a synthetic vision (sec. 0356, 0365,	<p>[0356] a synthetic vision display</p> <p>[0365] The two video monitors are illustratively used to display real-time data linked camera imagery from two air vehicles having cameras (of course, fewer, more or none of the vehicles might have cameras and the number of monitor displays can be altered accordingly). In accordance with one</p>

<p>0388,</p> <p>0390) is not used to control said unmanned aerial vehicle said unmanned aerial vehicle is flown using an autonomous control system</p>	<p>embodiment, camera imagery is recorded on videotapes during a mission. In accordance with one embodiment, the two repeater displays are used to provide redundant views of the GUI and synthetic vision display. The laptop illustratively serves as a GUI backup in the event that the main GUI fails.</p> <p>[0388] In one aspect of the present invention, synthetic vision display technical approach of the present invention is based upon integrating advanced simulated visuals, originally developed for training purposes, into UAV operational systems. In accordance with one embodiment, the simulated visuals are integrated with data derived from the ground control station during flight to enable real-time synthetic visuals.</p> <p>[0390] In one aspect of the present invention, through GUI display 2622, an operator can maintain a variable level of control over a UAV, from fully manual to fully autonomous, with simple user-friendly inputs. For example, if an operator decides to divert a UAV to a new route, the operator has a plurality of options to select from. The following are examples of some of the options that an operator has. Those skilled in the art should recognize that this is not an exhaustive list. In one embodiment, the operator could graphically edit the existing route on mission situation display 2629 by adding a waypoint or orbit pattern in the vicinity of a desired target region. Prior to accepting the edited route, the control system evaluates the revised route against the vehicle performance capability as well as terrain obstructions. If the route is within acceptable bounds, the control system registers the modified route and maneuvers the vehicle accordingly. In another</p>
--	---

<p>(autopilot, sec 0346 to 0350,</p>	<p>embodiment, the operator could select a park mode on selections pane 2630. After selected, the control system queues the operator to click the location of and graphical size (via a mouse) the desired orbit pattern in which the vehicle will fly while "parked" over a desired target. In another embodiment, the operator can select a manual control mode on selections pane 2630. By selecting RDC (remote directional command), for example, the control system controls the UAV into a constant altitude, heading and speed flight until the operator instructs a maneuver. While in RDC mode, the operator can either pseudo-manually direct the UAV using the control stick (e.g. joystick) or the operator can program a fixed heading, altitude and speed using the control options provided in selections pane 2630.</p> <p>[0346] In accordance with one embodiment, an exemplary translation layer implementation will now be provided. After the guidance algorithms execute, the outputs are translated to the native vehicle autopilot commands. The equations below provide example kinematic translations from the guidance acceleration commands to native vehicle autopilot commands. These equations demonstrate the principal that vehicle motion is activated through acceleration. The methods that various vehicles employ to generate acceleration are numerous (bank angle autopilot, acceleration autopilot, heading control autopilot, altitude control autopilot, etc). Since the control algorithms described herein generate acceleration commands that can be kinematically translated into any of these native autopilot commands, the guidance algorithms truly provide a generalized library of control laws that can control any vehicle through that vehicle's native atomic functions. Ubiquitous</p>
--------------------------------------	---

acceleration control techniques enable VACS to synthesize control commands for any vehicle, including air, ground, or sea-based.  $a_v$  = vertical plane acceleration command  $a_h$  = horizontal plane acceleration command  $\theta = \tan^{-1} \left( \frac{a_h}{a_v} \right)$  = bank angle command  $T = \sqrt{a_v^2 + a_h^2}$  = total body acceleration command  $\dot{\theta} = \frac{a_h}{V}$  = turn rate command  $\dot{\psi} = \dot{\theta} - 1 + \dot{\theta}$  = heading command  $\dot{\psi} = (a_v - g) / V$  = flight path rate command  $\dot{\psi} = \dot{\theta} - 1 + \dot{\theta}$  = flight path angle command  $\dot{h} = V \sin(\theta)$  = climb rate command  $\dot{h} = \dot{h} = 1 + \dot{h} \cdot t$  = altitude command Eq. 57

[0347] Additional functionality that can be enabled in a translation layer is means for discouraging or preventing an operator (e.g., the human or non-human operator interfacing the VACS architecture) from overdriving, stalling, or spinning the vehicle frame. This being said, limiting algorithms can also be employed in the guidance or autopilot functions.

[0348] X. Autopilot

[0349] As has been addressed, the present invention is not limited to, and does not require, a particular autopilot system. The control system and architecture embodiments of the present invention can be adapted to accommodate virtually any autopilot system.

[0350] For the purpose of providing an example, an illustrative suitable autopilot software system will now be described. The illustrative autopilot system incorporates a three-axis design (pitch and yaw with an attitude control loop in the roll axis) for vehicle stabilization and guidance



command tracking. The autopilot software design incorporates flight control techniques, which allow vehicle control algorithms to dynamically adjust airframe stabilization parameters in real-time during flight. The flight computer is programmed directly with the airframe physical properties, so that it can automatically adjust its settings with changes in airframe configuration, aerodynamic properties, and/or flight state. This provides for a simple and versatile design, and possesses the critical flexibility needed when adjustments to the airframe configuration become necessary. The three-loop design includes angular rate feedback for stability augmentation, attitude feedback for closed-loop stiffness, and acceleration feedback for command tracking. In addition, an integral controller in the forward loop illustratively provides enhanced command tracking, low frequency disturbance rejection and an automatic trim capability.

0390-0329).

{The Examiner may have meant 0390-0392. Otherwise the range is not credible}

[0390] In one aspect of the present invention, through GUI display 2622, an operator can maintain a variable level of control over a UAV, from fully manual to fully autonomous, with simple user-friendly inputs. For example, if an operator decides to divert a UAV to a new route, the operator has a plurality of options to select from. The following are examples of some of the options that an operator has. Those skilled in the art should recognize that this is not an exhaustive list. In one embodiment, the operator could graphically edit the existing route on mission situation display 2629 by adding a waypoint or orbit pattern in the vicinity of a desired target region. Prior to accepting the edited route, the control system

evaluates the revised route against the vehicle performance capability as well as terrain obstructions. If the route is within acceptable bounds, the control system registers the modified route and maneuvers the vehicle accordingly. In another embodiment, the operator could select a park mode on selections pane 2630. After selected, the control system queues the operator to click the location of and graphical size (via a mouse) the desired orbit pattern in which the vehicle will fly while "parked" over a desired target. In another embodiment, the operator can select a manual control mode on selections pane 2630. By selecting RDC (remote directional command), for example, the control system controls the UAV into a constant altitude, heading and speed flight until the operator instructs a maneuver. While in RDC mode, the operator can either pseudo-manually direct the UAV using the control stick (e.g. joystick) or the operator can program a fixed heading, altitude and speed using the control options provided in selections pane 2630.

[0391] The described Intelligent displays with smart variables represent an effective approach to actively displaying information for different types of vehicles. However, a problem can arise when a new vehicle is integrated into the ground control station with a completely foreign command and control interface. Under these circumstances, the ground control station is not concerned about displaying data, but is tasked to provide a command and control interface for the operator to perform the required operations. This conundrum is the motivation for another embodiment of the present invention, namely, the integration of vehicle specific panels in the ground control station.

[0392] In one embodiment, a generic vehicle class (GVC) is illustratively a software component that provides a rapid development environment API to add new vehicle classes and types to the ground control station. The GVC also illustratively serves as a software construct that allows the inclusion of multiple vehicles within the ground control station framework. One of the variables in the application is a vector of pointers to a generic vehicle class. This list is constructed by allocating new specific vehicles and returning a type case to the base generic vehicle class. When a new vehicle is integrated into the ground control station, the generic vehicle class provides all of the virtual functions to integrate with system control components (e.g., to integrate with a map display, a communications package, PCIG imagery and/or appropriate display windows). An important object in the application framework is illustratively a pointer to the current vehicle generic class. When the user switches vehicles, this pointer is updated and all displays grab the appropriate smart variables from the pointer to the new base class. This is the mechanism by which windows immediately update to the current vehicle information whenever the user switches vehicles. The default windows use the pointer to the current vehicle to grab information. In this manner, if the user switches to a new vehicle with a different set of datalink variables, that fact is immediately apparent on the display windows.

Therefore, it would have been obvious to one of ordinary skill in the art at the time the invention

was made to modify Margolin as taught by Duggan for the purpose of incorporating an autopilot to ensure smooth transitions (Duggan abstract, sec 0014, 0085, 0086).

The different embodiments in both prior arts are combinable as it would be obvious to one [sic] having ordinary skill in the art.

#### **Abstract**

Embodiments are disclosed for a vehicle control system and related sub-components that together provide an operator with a plurality of specific modes of operation, wherein various modes of operation incorporate different levels of autonomous control. Through a control user interface, an operator can move between certain modes of control even after vehicle deployment. Specialized autopilot system components and methods are employed to ensure smooth transitions between control modes. Empowered by the multi-modal control system, an operator can even manage multiple vehicles simultaneously.

[0014] Embodiments of the present invention pertain to a hierarchical control system, user interface system, and control architecture that together incorporate a broad range of user-selectable control modes representing variable levels of autonomy and vehicle control functionality. A unified autopilot is provided to process available modes and mode transitions. An intelligence synthesizer is illustratively provided to assist in resolving functional conflicts and transitioning between control modes, although certain resolutions and transitions can be incorporated directly into the functional sub-components associated with the different control modes. In accordance with one embodiment, all modes and transitions are funneled through an acceleration-based autopilot system. Accordingly, control commands and transitions are generally reduced to an acceleration vector to

be processed by a centralized autopilot system.

[0085] As will be discussed in greater detail below, the control system and architecture embodiments of the present invention essentially enable any autopilot design to support control of a vehicle in numerous control modes that are executed with switches between modes during flight. All control modes are supported even in the presence of sensor errors, such as accelerometer and gyro biases. This robustness is at least partially attributable to the fact that the closed-loop system, in all control modes, is essentially slaved to an inertial path and, hence, the sensor biases wash out in the closed loop, assuming the biases are not so grossly large that they induce stability problems in the autopilot system. Furthermore, winds are generally not an issue in the overall control scheme in that the flight control system will regulate to the inertial path, adjusting for winds automatically in the closed loop. Given the precision afforded by inertial navigation aided by GPS technology, inertial path regulation offers a highly effective and robust UAV control approach. Generally speaking, the autopilot system functions such that winds, medium Dryden turbulence levels, sensor errors, airframe aerodynamic and mass model parameter uncertainties, servo non-linearity (slew rate limits, etc.), and various other atmospheric and noise disturbances will non have a critically negative impact on flight path regulation.

[0086] Component 408 receives commands generated by component 404 and filtered by autopilot component 406. The commands received by component 408 are executed to actually manipulate the vehicle's control surfaces. Autopilot component 406 then continues to monitor vehicle stabilization

	and/or command tracking, making additional commands to component 408 as necessary.
--	--

1

2 At the beginning of this subsection, the Examiner asserts, “Margolin did not disclose that the  
3 vehicle is flown using an autonomous control system. However, Duggan teach of a system for  
4 safely flying an unmanned aerial vehicle in civilian airspace comprising: ...”

5

6 The Examiner’s statement, “However, Duggan teach of a system for safely flying an unmanned  
7 aerial vehicle in civilian airspace comprising: ...” is conclusory and is not supported by the  
8 Examiner’s citations to Duggan.

9

10 In addition, none of the Duggan citations teach that either synthetic vision or Duggan’s Variable  
11 Autonomy System is used “during at least selected phases of the flight of said unmanned aerial  
12 vehicle” which is a limitation in Applicant’s Claim 1.

13

14 Duggan fails to teach the limitation that his Variable Autonomy System is used during selected  
15 phases of a UAV’s flight and Margolin ‘724 fails to teach the limitation that synthetic vision is used  
16 during selected phases of a UAV’s flight. Therefore, the combination of Duggan and Margolin ‘724  
17 does not read on Applicant’s Claim 1.

18

19 As cited above by Applicant, MPEP 2143.03 “**All Claim Limitations must be Considered**” states:  
20 “all words in a claim must be considered in judging the patentability of that claim against the prior  
21 art.” *In re Wilson*, 424 F.2d 1382, 1385, 165 USPQ 494, 496 (CCPA 1970).”

22

23 The Examiner has failed his duty under MPEP 2143.03 (and in view of *Wehling*) to present a *prima*  
24 *facie* case of obviousness for rejecting Applicant’s Claim 1.

25

26 **Examiner’s Regarding Claim 2**, a claim dependent on Claim 1. Applicant has shown that Claim 1  
27 is nonobvious. Therefore, under **2143.03 All Claim Limitations Must Be Considered**, Claim 2 is  
28 non-obvious.

29

**2143.03 All Claim Limitations Must Be ~~\*\*\*>~~Considered< [R-6]**

1 \*\* "All words in a claim must be considered in judging the patentability of that claim against  
2 the prior art." *In re Wilson*, 424 F.2d 1382, 1385, 165 USPQ 494, 496 (CCPA 1970). If an  
3 independent claim is nonobvious under 35 U.S.C. 103, then any claim depending therefrom is  
4 nonobvious. *In re Fine*, 837 F.2d 1071, 5 USPQ2d 1596 (Fed. Cir. 1988).

5  
6 **Examiner's Regarding Claim 3**, a claim dependent on Claim 1. Applicant has shown that Claim 1  
7 is nonobvious. Therefore, under 2143.03 **All Claim Limitations Must Be Considered**, Claim 3 is  
8 non-obvious.

9 **2143.03 All Claim Limitations Must Be ~~Considered~~ [R-6]**

10 \*\* "All words in a claim must be considered in judging the patentability of that claim against  
11 the prior art." *In re Wilson*, 424 F.2d 1382, 1385, 165 USPQ 494, 496 (CCPA 1970). If an  
12 independent claim is nonobvious under 35 U.S.C. 103, then any claim depending therefrom is  
13 nonobvious. *In re Fine*, 837 F.2d 1071, 5 USPQ2d 1596 (Fed. Cir. 1988).

14  
15 **Examiner's Regarding Claim 4**, a claim dependent on Claim 1. Applicant has shown that Claim 1  
16 is nonobvious. Therefore, under 2143.03 **All Claim Limitations Must Be Considered**, Claim 4 is  
17 non-obvious.

18 **2143.03 All Claim Limitations Must Be ~~Considered~~ [R-6]**

19 \*\* "All words in a claim must be considered in judging the patentability of that claim against  
20 the prior art." *In re Wilson*, 424 F.2d 1382, 1385, 165 USPQ 494, 496 (CCPA 1970). If an  
21 independent claim is nonobvious under 35 U.S.C. 103, then any claim depending therefrom is  
22 nonobvious. *In re Fine*, 837 F.2d 1071, 5 USPQ2d 1596 (Fed. Cir. 1988).

23  
24 **Examiner:**

Regarding claim 5, Margolin (abstract; figs. 1-7; col. 3, lines 8-67; col. 4, lines 1-67; col. 5, lines 1-67) in view of Duggan disclose a system for safely flying an unmanned aerial vehicle in civilian airspace comprising:

- (a) a ground station equipped with a synthetic vision system;
- (b) an unmanned aerial vehicle capable of supporting said synthetic vision system;
- (c) a remote pilot operating said ground station;

- (d) a communications link between said unmanned aerial vehicle and said ground station;
- e) a system onboard said unmanned aerial vehicle for detecting the presence and position of nearby aircraft and communicating this information to said remote pilot;

whereas said remote pilot uses said synthetic vision system to control said unmanned aerial vehicle during at least selected phases of the flight of said unmanned aerial vehicle, and during those phases of the flight of said unmanned aerial vehicle when said synthetic vision system is not used to control said unmanned aerial vehicle said unmanned aerial vehicle is flown using an autonomous control system, and

whereas the selected phases of the flight of said unmanned aerial vehicle comprise:

(a) when said unmanned aerial vehicle is within a selected range of an airport or other designated location and is below a first specified altitude;

(b) when said unmanned aerial vehicle is outside said selected range of an airport or other designated location and is below a second specified altitude.

1

**Applicant:**

2 In Margolin '724: Column 3, lines 8-67; Column 4, lines 1-67; and Column 5, lines 1-67 form a  
3 continuous passage from Column 3, line 8 to Column 5, line 67. This passage of approximately  
4 1619 words forms the core of the Margolin '724 DETAILED DESCRIPTION. The remainder of the  
5 Margolin '724 DETAILED DESCRIPTION teaches additional topics such as **Flight Control** (with  
6 headings *Flight Control*, *Direct Control Non-Remotely Piloted Vehicles*, *Computer Mediated Non-*  
7 *Remotely Piloted Vehicles*, *Second Order Flight Control Mode*, *First Order Flight Control Mode*  
8 {See Column 6, line 19 - Column 8, line 3}, the features of a Control Panel (See Column 8, line 64  
9 - Column 9, line 18}, the use of a Head-Mounted Display {See Column 9, lines 19 - 32}, the use of  
10 the invention for training {See Column 9, lines 33 - 63}, and **The Database** {See Column 9, line 64  
11 - Column 10, line 50.}

12

13  
14 The Examiner cites Figures 1 - 7 in Margolin '724. These constitute all the figures in Margolin  
15 '724.

16

17 The Examiner also cites the Abstract in Margolin '724. According to **608.01(b) Abstract of the**

**Disclosure [R-7]:**

18  
19 **37 CFR 1.72 Title and abstract.**



1 \*\*\*\*\*

2 (b) A brief abstract of the technical disclosure in the specification must commence on a  
3 separate sheet, preferably following the claims, under the heading "Abstract" or "Abstract of  
4 the Disclosure." The sheet or sheets presenting the abstract may not include other parts of the  
5 application or other material. The abstract in an application filed under 35 U.S.C. 111 may not  
6 exceed 150 words in length. The purpose of the abstract is to enable the United States Patent  
7 and Trademark Office and the public generally to determine quickly from a cursory inspection  
8 the nature and gist of the technical disclosure.<

9  
10 {Emphasis added}

11  
12 The popular interpretation of 608.01(b) is that the purpose of the Abstract is to provide search  
13 terms. In any event, the Abstract in Margolin '724 does not say anything about civilian airspace.

14  
15 The Examiner has made a conclusory statement by repeating the title of Applicant's invention  
16 (leaving out the words "and method") and citing the core of the DETAILED DESCRIPTION in  
17 Margolin '724.

18  
19 In the remaining sections of the Examiner's rejection of Applicant's Claim 5 he asserts that he has  
20 found all of the elements and limitations of Applicant's invention.

21  
22 It is not surprising that some of the elements of Applicant's invention are present in Margolin '724  
23 since Margolin '724 is probably the pioneering patent for the use of what is now called *synthetic*  
24 *vision* in remotely piloted aircraft (now commonly called Unmanned Aerial Vehicles) and  
25 Applicant's present invention uses synthetic vision as an element.

26  
27 However, there are limitations in Applicant's current invention that are not present in Margolin  
28 '724.

29  
30 Examiner:

31 whereas said remote pilot uses said synthetic vision system to control said unmanned aerial  
32 vehicle during at least selected phases of the flight of said unmanned aerial vehicle, and during

1 those phases of the flight of said unmanned aerial vehicle when said synthetic vision system is  
2 not used to control said unmanned aerial vehicle said unmanned aerial vehicle is flown using an  
3 autonomous control system, and

4  
5 whereas the selected phases of the flight of said unmanned aerial vehicle comprise:

6 (a) when said unmanned aerial vehicle is within a selected range of an airport or other designated  
7 location and is below a first specified altitude;

8 (b) when said unmanned aerial vehicle is outside said selected range of an airport or other  
9 designated location and is below a second specified altitude.

10  
11 The Examiner has not even attempted to show where these limitations are taught in Margolin '724.  
12 As noted, he has cited the core of the Margolin '724 DETAILED DESCRIPTION, all of the  
13 drawings, and the abstract. His rejection is purely conclusory and does not follow the requirements  
14 for making a *prima facie* rejection required by MPEP § 2143.03 **All Claim Limitations Must Be**  
15 **Considered**, *KSR*, and *Wehling*, as well as MPEP § 2142 **ESTABLISHING A PRIMA FACIE**  
16 **CASE OF OBVIOUSNESS**.

17  
18 The Examiner continues:

19 *Margolin did not disclose that the vehicle is flown using an autonomous control system.*

20 *However, Duggan teach of a system for safely flying an unmanned aerial vehicle in civilian*  
21 *airspace comprising:*

22 *a ground station controlling an unmanned aerial vehicle (sec. 0352, 00353), wherein*  
23 *during phases of a flight of an unmanned aerial vehicle (UAV, sec 0318, 0322, 0353) when a*  
24 *synthetic vision (sec. 0356, 0365, 0388, 0390) is not used to control said unmanned aerial*  
25 *vehicle said unmanned aerial vehicle is flown using an autonomous control system (autopilot,*  
26 *sec 0346 to 0350, 0390-0329).*

27 *Therefore, it would have been obvious to one of ordinary skill in the art at the time the*  
28 *invention was made to modify Margolin as taught by Duggan for the purpose of incorporating*  
29 *an autopilot to ensure smooth transitions (Duggna abstract, sec 0014, 0085, 0086).*

1                    *The different embodiments in both prior arts are combinable as it would be obvious to ne*  
 2                    *having ordinary skill in the art.*

<u>Examiner</u>	<u>Duggan</u>
<p>Margolin did not disclose that the vehicle is flown using an autonomous control system. However, Duggan teach of a system for safely flying an unmanned aerial vehicle in civilian airspace comprising:                      a ground station controlling an unmanned aerial vehicle (sec. 0352,                       00353),</p>	<p>[0352] In one aspect of the present invention, an operator station (also referred to as the ground control station or GCS) is designed to accommodate command and control of multiple vehicles or a single vehicle by a single operator. In accordance with one embodiment, the ground control station is platform independent and implements an application program interface that provides windowing and communications interfaces (e.g., the platform is implemented in Open Source wxWindows API). The underlying operating system is illustratively masked and enables a developer to code in a high level environment.</p> <p>[0353] In one embodiment, the ground control station incorporates several specialized user interface concepts designed to effectively support a single operator tasked to control multiple vehicles. The GCS also illustratively supports manual control and sensor steering modes. In the manual control mode, the operator can assume control authority of the vehicles individually from the ground control station at any time in flight. In the sensor steering mode, a vehicle will autonomously fly in the direction the operator is manually pointing the on-board imaging sensor (e.g., operator views video output from a digital camera on a TV interface, computer screen display, etc.). A custom data link is illustratively, utilized to support a two-way transfer of data between the ground control station and the UAV's. These design concepts together provide a flexible, multiple vehicle</p>

<p>wherein during phases of a flight of an unmanned aerial vehicle (UAV, sec 0318,</p> <p>0322,</p> <p>0353)</p>	<p>control system. The details of the concepts are discussed below.</p> <p>[0318] If the pilot chooses a surveillance location outside the total FOV, then the outer loop guidance will illustratively follow a command-to-LOS mode guide law until the UAV flight path points toward the target. Once the desired starting-point comes within a minimum range threshold, the guidance automatically trips into a loiter pattern (either constant-radius or elliptical) to maintain a station with a single key-click while he/she conducts other activities. FIGS. 22A &amp; 22B together demonstrate the surveillance-point approach scenario.</p> <p>[0322] In accordance with one aspect of the present invention, sensor-slave mode commands are generated by an autonomous line-of-sight driven function, in which the command objectives are generated by the necessities of the function rather than by an operator. For example, a function designed to command a raster-scan of a particular surveillance area, or a function designed to scan a long a roadway could be used to generate sensor slave commands. Another example is a function designed to generate line-of-sight commands for UAV-to-UAV rendezvous formation flying.</p> <p>[0353] In one embodiment, the ground control station incorporates several specialized user interface concepts designed to effectively support a single operator tasked to control multiple vehicles. The GCS also illustratively supports manual control and sensor steering modes. In the manual control mode, the operator can assume control authority of the vehicles individually from the ground control station at any</p>
--	---

	<p>time in flight. In the sensor steering mode, a vehicle will autonomously fly in the direction the operator is manually pointing the on-board imaging sensor (e.g., operator views video output from a digital camera on a TV interface, computer screen display, etc.). A custom data link is illustratively, utilized to support a two-way transfer of data between the ground control station and the UAV's. These design concepts together provide a flexible, multiple vehicle control system. The details of the concepts are discussed below.</p>
when a synthetic vision (sec. 0356,	[0356] a synthetic vision display
0365,	[0365] The two video monitors are illustratively used to display real-time data linked camera imagery from two air vehicles having cameras (of course, fewer, more or none of the vehicles might have cameras and the number of monitor displays can be altered accordingly). In accordance with one embodiment, camera imagery is recorded on videotapes during a mission. In accordance with one embodiment, the two repeater displays are used to provide redundant views of the GUI and synthetic vision display. The laptop illustratively serves as a GUI backup in the event that the main GUI fails.
0388,	[0388] In one aspect of the present invention, synthetic vision display technical approach of the present invention is based upon integrating advanced simulated visuals, originally developed for training purposes, into UAV operational systems. In accordance with one embodiment, the simulated visuals are integrated with data derived from the ground control station during flight to enable real-time synthetic

<p>0390) is not used to control said unmanned aerial vehicle said unmanned aerial vehicle is flown using an autonomous control system</p>	<p>visuals.</p> <p>[0390] In one aspect of the present invention, through GUI display 2622, an operator can maintain a variable level of control over a UAV, from fully manual to fully autonomous, with simple user-friendly inputs. For example, if an operator decides to divert a UAV to a new route, the operator has a plurality of options to select from. The following are examples of some of the options that an operator has. Those skilled in the art should recognize that this is not an exhaustive list. In one embodiment, the operator could graphically edit the existing route on mission situation display 2629 by adding a waypoint or orbit pattern in the vicinity of a desired target region. Prior to accepting the edited route, the control system evaluates the revised route against the vehicle performance capability as well as terrain obstructions. If the route is within acceptable bounds, the control system registers the modified route and maneuvers the vehicle accordingly. In another embodiment, the operator could select a park mode on selections pane 2630. After selected, the control system queues the operator to click the location of and graphical size (via a mouse) the desired orbit pattern in which the vehicle will fly while "parked" over a desired target. In another embodiment, the operator can select a manual control mode on selections pane 2630. By selecting RDC (remote directional command), for example, the control system controls the UAV into a constant altitude, heading and speed flight until the operator instructs a maneuver. While in RDC mode, the operator can either pseudo-manually direct the UAV using the control stick (e.g. joystick) or the operator can program a fixed heading, altitude and speed using the control</p>
---	--

(autopilot, sec 0346 to 0350,

options provided in selections pane 2630.

[0346] In accordance with one embodiment, an exemplary translation layer implementation will now be provided. After the guidance algorithms execute, the outputs are translated to the native vehicle autopilot commands. The equations below provide example kinematic translations from the guidance acceleration commands to native vehicle autopilot commands. These equations demonstrate the principal that vehicle motion is activated through acceleration. The methods that various vehicles employ to generate acceleration are numerous (bank angle autopilot, acceleration autopilot, heading control autopilot, altitude control autopilot, etc). Since the control algorithms described herein generate acceleration commands that can be kinematically translated into any of these native autopilot commands, the guidance algorithms truly provide a generalized library of control laws that can control any vehicle through that vehicle's native atomic functions. Ubiquitous acceleration control techniques enable VACS to synthesize control commands for any vehicle, including air, ground, or sea-based. 35  $a_v$  = vertical plane acceleration command  $a_h$  = horizontal plane acceleration command  $\theta = \tan^{-1} \left( \frac{a_h}{a_v} \right)$  = bank angle command  $a_T = \sqrt{a_v^2 + a_h^2}$  = total body acceleration command  $\dot{\theta} = \frac{a_h}{V}$  = turn rate command  $\dot{\theta} = \dot{\theta} - 1 + \dot{\theta}$  = heading command  $\dot{\theta} = \left( \frac{a_v - g}{V} \right)$  = flight path rate command  $\dot{\theta} = \dot{\theta} - 1 + \dot{\theta}$  = flight path angle command  $\dot{h} = V \sin(\theta)$  = climb rate command  $\dot{h} = \dot{h} - 1 + \dot{h}$  = altitude command Eq . 57

[0347] Additional functionality that can be enabled in a translation layer is means for discouraging or preventing an

operator (e.g., the human or non-human operator interfacing the VACS architecture) from overdriving, stalling, or spinning the vehicle frame. This being said, limiting algorithms can also be employed in the guidance or autopilot functions.

[0348] X. Autopilot

[0349] As has been addressed, the present invention is not limited to, and does not require, a particular autopilot system. The control system and architecture embodiments of the present invention can be adapted to accommodate virtually any autopilot system.

[0350] For the purpose of providing an example, an illustrative suitable autopilot software system will now be described. The illustrative autopilot system incorporates a three-axis design (pitch and yaw with an attitude control loop in the roll axis) for vehicle stabilization and guidance command tracking. The autopilot software design incorporates flight control techniques, which allow vehicle control algorithms to dynamically adjust airframe stabilization parameters in real-time during flight. The flight computer is programmed directly with the airframe physical properties, so that it can automatically adjust its settings with changes in airframe configuration, aerodynamic properties, and/or flight state. This provides for a simple and versatile design, and possesses the critical flexibility needed when adjustments to the airframe configuration become necessary. The three-loop design includes angular rate feedback for stability augmentation, attitude feedback for closed-loop stiffness, and acceleration feedback for command tracking. In addition, an



0390-0329).

integral controller in the forward loop illustratively provides enhanced command tracking, low frequency disturbance rejection and an automatic trim capability.

{The Examiner may have meant 0390-0392. Otherwise the range is not credible}

[0390] In one aspect of the present invention, through GUI display 2622, an operator can maintain a variable level of control over a UAV, from fully manual to fully autonomous, with simple user-friendly inputs. For example, if an operator decides to divert a UAV to a new route, the operator has a plurality of options to select from. The following are examples of some of the options that an operator has. Those skilled in the art should recognize that this is not an exhaustive list. In one embodiment, the operator could graphically edit the existing route on mission situation display 2629 by adding a waypoint or orbit pattern in the vicinity of a desired target region. Prior to accepting the edited route, the control system evaluates the revised route against the vehicle performance capability as well as terrain obstructions. If the route is within acceptable bounds, the control system registers the modified route and maneuvers the vehicle accordingly. In another embodiment, the operator could select a park mode on selections pane 2630. After selected, the control system queues the operator to click the location of and graphical size (via a mouse) the desired orbit pattern in which the vehicle will fly while "parked" over a desired target. In another embodiment, the operator can select a manual control mode on selections pane 2630. By selecting RDC (remote directional command), for example, the control system controls the UAV into a constant altitude, heading and speed

flight until the operator instructs a maneuver. While in RDC mode, the operator can either pseudo-manually direct the UAV using the control stick (e.g. joystick) or the operator can program a fixed heading, altitude and speed using the control options provided in selections pane 2630.

[0391] The described Intelligent displays with smart variables represent an effective approach to actively displaying information for different types of vehicles. However, a problem can arise when a new vehicle is integrated into the ground control station with a completely foreign command and control interface. Under these circumstances, the ground control station is not concerned about displaying data, but is tasked to provide a command and control interface for the operator to perform the required operations. This conundrum is the motivation for another embodiment of the present invention, namely, the integration of vehicle specific panels in the ground control station.

[0392] In one embodiment, a generic vehicle class (GVC) is illustratively a software component that provides a rapid development environment API to add new vehicle classes and types to the ground control station. The GVC also illustratively serves as a software construct that allows the inclusion of multiple vehicles within the ground control station framework. One of the variables in the application is a vector of pointers to a generic vehicle class. This list is constructed by allocating new specific vehicles and returning a type case to the base generic vehicle class. When a new vehicle is integrated into the ground control station, the generic vehicle class provides all of the virtual functions to

integrate with system control components (e.g., to integrate with a map display, a communications package, PCIG imagery and/or appropriate display windows). An important object in the application framework is illustratively a pointer to the current vehicle generic class. When the user switches vehicles, this pointer is updated and all displays grab the appropriate smart variables from the pointer to the new base class. This is the mechanism by which windows immediately update to the current vehicle information whenever the user switches vehicles. The default windows use the pointer to the current vehicle to grab information. In this manner, if the user switches to a new vehicle with a different set of datalink variables, that fact is immediately apparent on the display windows.

Therefore, it would have been obvious to one of ordinary skill in the art at the time the invention was made to modify Margolin as taught by Duggan for the purpose of incorporating an autopilot to ensure smooth transitions (Duggna abstract, sec 0014, 0085, 0086).

The different embodiments in both prior arts are combinable as it would be obvious to one of ordinary skill in the art.

**Abstract**

Embodiments are disclosed for a vehicle control system and related sub-components that together provide an operator with a plurality of specific modes of operation, wherein various modes of operation incorporate different levels of autonomous control. Through a control user interface, an operator can move between certain modes of control even after vehicle deployment. Specialized autopilot system components and methods are employed to ensure smooth transitions between

control modes. Empowered by the multi-modal control system, an operator can even manage multiple vehicles simultaneously.

[0014] Embodiments of the present invention pertain to a hierarchical control system, user interface system, and control architecture that together incorporate a broad range of user-selectable control modes representing variable levels of autonomy and vehicle control functionality. A unified autopilot is provided to process available modes and mode transitions. An intelligence synthesizer is illustratively provided to assist in resolving functional conflicts and transitioning between control modes, although certain resolutions and transitions can be incorporated directly into the functional sub-components associated with the different control modes. In accordance with one embodiment, all modes and transitions are funneled through an acceleration-based autopilot system. Accordingly, control commands and transitions are generally reduced to an acceleration vector to be processed by a centralized autopilot system.

[0085] As will be discussed in greater detail below, the control system and architecture embodiments of the present invention essentially enable any autopilot design to support control of a vehicle in numerous control modes that are executed with switches between modes during flight. All control modes are supported even in the presence of sensor errors, such as accelerometer and gyro biases. This robustness is at least partially attributable to the fact that the closed-loop system, in all control modes, is essentially slaved to an inertial path and, hence, the sensor biases wash out in the closed loop,

assuming the biases are not so grossly large that they induce stability problems in the autopilot system. Furthermore, winds are generally not an issue in the overall control scheme in that the flight control system will regulate to the inertial path, adjusting for winds automatically in the closed loop. Given the precision afforded by inertial navigation aided by GPS technology, inertial path regulation offers a highly effective and robust UAV control approach. Generally speaking, the autopilot system functions such that winds, medium Dryden turbulence levels, sensor errors, airframe aerodynamic and mass model parameter uncertainties, servo non-linearity (slew rate limits, etc.), and various other atmospheric and noise disturbances will non have a critically negative impact on flight path regulation.

[0086] Component 408 receives commands generated by component 404 and filtered by autopilot component 406. The commands received by component 408 are executed to actually manipulate the vehicle's control surfaces. Autopilot component 406 then continues to monitor vehicle stabilization and/or command tracking, making additional commands to component 408 as necessary.

1

2

3 At the beginning of this subsection, the Examiner asserts, “Margolin did not disclose that the  
4 vehicle is flown using an autonomous control system. However, Duggan teach of a system for  
5 safely flying an unmanned aerial vehicle in civilian airspace comprising: ...”

6

7 The Examiner’s statement, “However, Duggan teach of a system for safely flying an unmanned  
8 aerial vehicle in civilian airspace comprising: ...” is conclusory and is not supported by the  
9 Examiner’s citations to Duggan.

10

1 In addition, none of the Duggan citations teach the limitations in Applicant's Claim 5 that either  
2 synthetic vision or Duggan's Variable Autonomy System is used:

- 3 1. "during at least selected phases of the flight of said unmanned aerial vehicle"
- 4 2. that the selected phases comprise:
  - 5 (a) when said unmanned aerial vehicle is within a selected range of an airport or other  
6 designated location and is below a first specified altitude;
  - 7 (b) when said unmanned aerial vehicle is outside said selected range of an airport or other  
8 designated location and is below a second specified altitude.

9  
10 Duggan fails to teach the limitation that his Variable Autonomy System is used during selected  
11 phases of a UAV's flight and Margolin '724 fails to teach the limitation that synthetic vision is used  
12 during selected phases of a UAV's flight. Therefore, the combination of Duggan and Margolin '724  
13 does not read on Applicant's Claim 5.

14  
15 As cited above by Applicant, MPEP 2143.03 "**All Claim Limitations must be Considered**" states:  
16 "all words in a claim must be considered in judging the patentability of that claim against the prior  
17 art." *In re Wilson*, 424 F.2d 1382, 1385, 165 USPQ 494, 496 (CCPA 1970)."

18  
19 The Examiner has failed his duty under MPEP 2143.03 (and in view of *Wehling*) to present a *prima*  
20 *facie* case of obviousness for rejecting Applicant's Claim 5.

21  
22 **Examiner's Regarding Claim 6**, a claim dependent on Claim 5. Applicant has shown that Claim 5  
23 is nonobvious. Therefore, under **2143.03 All Claim Limitations Must Be Considered**, Claim 6 is  
24 non-obvious.

25 **2143.03 All Claim Limitations Must Be ~~\*\*>~~Considered< [R-6]**

26 \*\* "All words in a claim must be considered in judging the patentability of that claim against  
27 the prior art." *In re Wilson*, 424 F.2d 1382, 1385, 165 USPQ 494, 496 (CCPA 1970). If an  
28 independent claim is nonobvious under 35 U.S.C. 103, then any claim depending therefrom is  
29 nonobvious. *In re Fine*, 837 F.2d 1071, 5 USPQ2d 1596 (Fed. Cir. 1988).

30

1 **Examiner's Regarding Claim 7**, a claim dependent on Claim 5. Applicant has shown that Claim 5  
2 is nonobvious. Therefore, under **2143.03 All Claim Limitations Must Be Considered**, Claim 7 is  
3 non-obvious.

4 **2143.03 All Claim Limitations Must Be ~~\*\*\*>~~Considered< [R-6]**

5 **\*\*** "All words in a claim must be considered in judging the patentability of that claim against  
6 the prior art." *In re Wilson*, 424 F.2d 1382, 1385, 165 USPQ 494, 496 (CCPA 1970). If an  
7 independent claim is nonobvious under 35 U.S.C. 103, then any claim depending therefrom is  
8 nonobvious. *In re Fine*, 837 F.2d 1071, 5 USPQ2d 1596 (Fed. Cir. 1988).

9  
10 **Examiner:**

Regarding claim 8, Margolin (abstract; figs. 1-7; col. 3, lines 8-67; col. 4, lines 1-67; col. 5, lines 1-67) in view of Duggan disclose a method for safely flying an unmanned aerial vehicle as part of a unmanned aerial system equipped with a synthetic vision system in civilian airspace comprising the steps of-

(a) using a remote pilot to fly said unmanned aerial vehicle using synthetic vision during at least selected phases of the flight of said unmanned aerial vehicle, and during those phases of the flight of said unmanned aerial vehicle when said synthetic vision system is not used to control said unmanned aerial vehicle an autonomous control system is used to fly said unmanned aerial vehicle;

(b) providing a system onboard said unmanned aerial vehicle for detecting the presence and position of nearby aircraft and communicating this information to said remote pilot.

11

12 **Applicant:**

13 In Margolin '724: Column 3, lines 8-67; Column 4, lines 1-67; and Column 5, lines 1-67 form a  
14 continuous passage from Column 3, line 8 to Column 5, line 67. This passage of approximately  
15 1619 words forms the core of the Margolin '724 DETAILED DESCRIPTION. The remainder of the  
16 Margolin '724 DETAILED DESCRIPTION teaches additional topics such as **Flight Control** (with  
17 headings *Flight Control*, *Direct Control Non-Remotely Piloted Vehicles*, *Computer Mediated Non-*  
18 *Remotely Piloted Vehicles*, *Second Order Flight Control Mode*, *First Order Flight Control Mode*  
19 {See Column 6, line 19 - Column 8, line 3}, the features of a Control Panel (See Column 8, line 64  
20 - Column 9, line 18}, the use of a Head-Mounted Display {See Column 9, lines 19 - 32}, the use of

1 the invention for training {See Column 9, lines 33 - 63}, and **The Database** {See Column 9, line 64  
2 - Column 10, line 50.}

3  
4 The Examiner cites Figures 1 - 7 in Margolin '724. These constitute all the figures in Margolin  
5 '724.

6  
7 The Examiner also cites the Abstract in Margolin '724. According to **608.01(b) Abstract of the**  
8 **Disclosure [R-7]:**

9 **37 CFR 1.72 Title and abstract.**

10 \*\*\*\*\*

11 (b) A brief abstract of the technical disclosure in the specification must commence on a  
12 separate sheet, preferably following the claims, under the heading "Abstract" or "Abstract of  
13 the Disclosure." The sheet or sheets presenting the abstract may not include other parts of the  
14 application or other material. The abstract in an application filed under 35 U.S.C. 111 may not  
15 exceed 150 words in length. The purpose of the abstract is to enable the United States Patent  
16 and Trademark Office and the public generally to determine quickly from a cursory inspection  
17 the nature and gist of the technical disclosure.<

18  
19 {Emphasis added}

20  
21 The popular interpretation of 608.01(b) is that the purpose of the Abstract is to provide search  
22 terms. In any event, the Abstract in Margolin '724 does not say anything about civilian airspace.

23  
24 The Examiner has made a conclusory statement by repeating the title of Applicant's invention  
25 (leaving out the words "and method") and citing the core of the DETAILED DESCRIPTION in  
26 Margolin '724.

27  
28 In the remaining sections of the Examiner's rejection of Applicant's Claim 8 he asserts that he has  
29 found the elements and limitations of Applicant's invention.

30 (a) using a remote pilot to fly said unmanned aerial vehicle using synthetic vision during at  
31 least selected phases of the flight of said unmanned aerial vehicle, and during those phases of  
32 the flight of said unmanned aerial vehicle when said synthetic vision system is not used to



1 control said unmanned aerial vehicle an autonomous control system is used to fly said  
2 unmanned aerial vehicle;

3 (b) providing a system onboard said unmanned aerial vehicle for detecting the presence and  
4 position of nearby aircraft and communicating this information to said remote pilot.  
5

6 The Examiner has not even attempted to show where these limitations are taught in Margolin '724.  
7 He has particularly failed to show where the following is taught:

8 (a) using a remote pilot to fly said unmanned aerial vehicle using synthetic vision during at  
9 least selected phases of the flight of said unmanned aerial vehicle, and during those phases of  
10 the flight of said unmanned aerial vehicle when said synthetic vision system is not used to  
11 control said unmanned aerial vehicle an autonomous control system is used to fly said  
12 unmanned aerial vehicle;  
13

14 As noted, he has cited the core of the Margolin '724 DETAILED DESCRIPTION, all of the  
15 drawings, and the abstract. His rejection is purely conclusory and does not follow the requirements  
16 for making a *prima facie* rejection required by MPEP § 2143.03 **All Claim Limitations Must Be**  
17 **Considered**, *KSR*, and *Wehling*, as well as MPEP § 2142 **ESTABLISHING A PRIMA FACIE**  
18 **CASE OF OBVIOUSNESS**.  
19

20 The Examiner continues:

21 *Margolin did not disclose that the vehicle is flown using an autonomous control system.*  
22 *However, Duggan teach of a system for safely flying an unmanned aerial vehicle in civilian*  
23 *airspace comprising:*

24 *a ground station controlling an unmanned aerial vehicle (sec. 0352, 00353), wherein*  
25 *during phases of a flight of an unmanned aerial vehicle (UAV, sec 0318, 0322, 0353) when a*  
26 *synthetic vision (sec. 0356, 0365, 0388, 0390) is not used to control said unmanned aerial*  
27 *vehicle said unmanned aerial vehicle is flown using an autonomous control system (autopilot,*  
28 *sec 0346 to 0350, 0390-0329).*

29 *Therefore, it would have been obvious to one of ordinary skill in the art at the time the*  
30 *invention was made to modify Margolin as taught by Duggan for the purpose of incorporating*  
31 *an autopilot to ensure smooth transitions (Duggna abstract, sec 0014, 0085, 0086).*

1        *The different embodiments in both prior arts are combinable as it would be obvious to one having*  
 2        *ordinary skill in the art.*

3

<u>Examiner</u>	<u>Duggan</u>
<p>Margolin did not disclose that the vehicle is flown using an autonomous control system. However, Duggan teach of a system for safely flying an unmanned aerial vehicle in civilian airspace comprising:  a ground station controlling an unmanned aerial vehicle (sec. 0352,   00353),</p>	<p>[0352] In one aspect of the present invention, an operator station (also referred to as the ground control station or GCS) is designed to accommodate command and control of multiple vehicles or a single vehicle by a single operator. In accordance with one embodiment, the ground control station is platform independent and implements an application program interface that provides windowing and communications interfaces (e.g., the platform is implemented in Open Source wxWindows API). The underlying operating system is illustratively masked and enables a developer to code in a high level environment.</p> <p>[0353] In one embodiment, the ground control station incorporates several specialized user interface concepts designed to effectively support a single operator tasked to control multiple vehicles. The GCS also illustratively supports manual control and sensor steering modes. In the manual control mode, the operator can assume control authority of the vehicles individually from the ground control station at any time in flight. In the sensor steering mode, a vehicle will autonomously fly in the direction the operator is manually pointing the on-board imaging sensor (e.g., operator views video output from a digital camera on a TV interface, computer screen display, etc.). A custom data link is illustratively, utilized to support a two-way transfer of data between the ground control station and the UAV's. These</p>

<p>wherein during phases of a flight of an unmanned aerial vehicle (UAV, sec 0318,</p> <p>0322,</p> <p>0353)</p>	<p>design concepts together provide a flexible, multiple vehicle control system. The details of the concepts are discussed below.</p> <p>[0318] If the pilot chooses a surveillance location outside the total FOV, then the outer loop guidance will illustratively follow a command-to-LOS mode guide law until the UAV flight path points toward the target. Once the desired staring-point comes within a minimum range threshold, the guidance automatically trips into a loiter pattern (either constant-radius or elliptical) to maintain a station with a single key-click while he/she conducts other activities. FIGS. 22A &amp; 22B together demonstrate the surveillance-point approach scenario.</p> <p>[0322] In accordance with one aspect of the present invention, sensor-slave mode commands are generated by an autonomous line-of-sight driven function, in which the command objectives are generated by the necessities of the function rather than by an operator. For example, a function designed to command a raster-scan of a particular surveillance area, or a function designed to scan a long a roadway could be used to generate sensor slave commands. Another example is a function designed to generate line-of-sight commands for UAV-to-UAV rendezvous formation flying.</p> <p>[0353] In one embodiment, the ground control station incorporates several specialized user interface concepts designed to effectively support a single operator tasked to control multiple vehicles. The GCS also illustratively supports manual control and sensor steering modes. In the manual control mode, the operator can assume control authority of the</p>
--	---

	<p>vehicles individually from the ground control station at any time in flight. In the sensor steering mode, a vehicle will autonomously fly in the direction the operator is manually pointing the on-board imaging sensor (e.g., operator views video output from a digital camera on a TV interface, computer screen display, etc.). A custom data link is illustratively, utilized to support a two-way transfer of data between the ground control station and the UAV's. These design concepts together provide a flexible, multiple vehicle control system. The details of the concepts are discussed below.</p>
when a synthetic vision (sec. 0356,	[0356] a synthetic vision display
0365,	[0365] The two video monitors are illustratively used to display real-time data linked camera imagery from two air vehicles having cameras (of course, fewer, more or none of the vehicles might have cameras and the number of monitor displays can be altered accordingly). In accordance with one embodiment, camera imagery is recorded on videotapes during a mission. In accordance with one embodiment, the two repeater displays are used to provide redundant views of the GUI and synthetic vision display. The laptop illustratively serves as a GUI backup in the event that the main GUI fails.
0388,	[0388] In one aspect of the present invention, synthetic vision display technical approach of the present invention is based upon integrating advanced simulated visuals, originally developed for training purposes, into UAV operational systems. In accordance with one embodiment, the simulated visuals are integrated with data derived from the ground

<p>0390) is not used to control said unmanned aerial vehicle said unmanned aerial vehicle is flown using an autonomous control system</p>	<p>control station during flight to enable real-time synthetic visuals.</p> <p>[0390] In one aspect of the present invention, through GUI display 2622, an operator can maintain a variable level of control over a UAV, from fully manual to fully autonomous, with simple user-friendly inputs. For example, if an operator decides to divert a UAV to a new route, the operator has a plurality of options to select from. The following are examples of some of the options that an operator has. Those skilled in the art should recognize that this is not an exhaustive list. In one embodiment, the operator could graphically edit the existing route on mission situation display 2629 by adding a waypoint or orbit pattern in the vicinity of a desired target region. Prior to accepting the edited route, the control system evaluates the revised route against the vehicle performance capability as well as terrain obstructions. If the route is within acceptable bounds, the control system registers the modified route and maneuvers the vehicle accordingly. In another embodiment, the operator could select a park mode on selections pane 2630. After selected, the control system queues the operator to click the location of and graphical size (via a mouse) the desired orbit pattern in which the vehicle will fly while "parked" over a desired target. In another embodiment, the operator can select a manual control mode on selections pane 2630. By selecting RDC (remote directional command), for example, the control system controls the UAV into a constant altitude, heading and speed flight until the operator instructs a maneuver. While in RDC mode, the operator can either pseudo-manually direct the UAV using the control stick (e.g. joystick) or the operator can</p>
---	--

(autopilot, sec 0346 to 0350,	<p>program a fixed heading, altitude and speed using the control options provided in selections pane 2630.</p>
	<p>[0346] In accordance with one embodiment, an exemplary translation layer implementation will now be provided. After the guidance algorithms execute, the outputs are translated to the native vehicle autopilot commands. The equations below provide example kinematic translations from the guidance acceleration commands to native vehicle autopilot commands. These equations demonstrate the principal that vehicle motion is activated through acceleration. The methods that various vehicles employ to generate acceleration are numerous (bank angle autopilot, acceleration autopilot, heading control autopilot, altitude control autopilot, etc). Since the control algorithms described herein generate acceleration commands that can be kinematically translated into any of these native autopilot commands, the guidance algorithms truly provide a generalized library of control laws that can control any vehicle through that vehicle's native atomic functions. Ubiquitous acceleration control techniques enable VACS to synthesize control commands for any vehicle, including air, ground, or sea-based.</p> <p> <math>a_v</math> = vertical plane acceleration command  <math>a_h</math> = horizontal plane acceleration command  <math>\theta = \tan^{-1} \left( \frac{a_h}{a_v} \right)</math> = bank angle command  <math>a_T = \sqrt{a_v^2 + a_h^2}</math> = total body acceleration command  <math>\dot{\theta} = \frac{a_h}{V}</math> = turn rate command  <math>i = i - 1 + \dot{\theta} \cdot t</math> = heading command  <math>\dot{\theta} = \left( \frac{a_v}{g} - 1 \right) \frac{V}{h}</math> = flight path rate command  <math>i = i - 1 + \dot{\theta} \cdot t</math> = flight path angle command  <math>h \cdot \dot{\theta} = V \sin(\theta)</math> = climb rate command  <math>h \cdot i = h \cdot i - 1 + h \cdot \dot{\theta} \cdot t</math> = altitude command Eq . 57 </p>
	<p>[0347] Additional functionality that can be enabled in a</p>

translation layer is means for discouraging or preventing an operator (e.g., the human or non-human operator interfacing the VACS architecture) from overdriving, stalling, or spinning the vehicle frame. This being said, limiting algorithms can also be employed in the guidance or autopilot functions.

[0348] X. Autopilot

[0349] As has been addressed, the present invention is not limited to, and does not require, a particular autopilot system. The control system and architecture embodiments of the present invention can be adapted to accommodate virtually any autopilot system.

[0350] For the purpose of providing an example, an illustrative suitable autopilot software system will now be described. The illustrative autopilot system incorporates a three-axis design (pitch and yaw with an attitude control loop in the roll axis) for vehicle stabilization and guidance command tracking. The autopilot software design incorporates flight control techniques, which allow vehicle control algorithms to dynamically adjust airframe stabilization parameters in real-time during flight. The flight computer is programmed directly with the airframe physical properties, so that it can automatically adjust its settings with changes in airframe configuration, aerodynamic properties, and/or flight state. This provides for a simple and versatile design, and possesses the critical flexibility needed when adjustments to the airframe configuration become necessary. The three-loop design includes angular rate feedback for stability augmentation, attitude feedback for closed-loop stiffness, and

0390-0329).

acceleration feedback for command tracking. In addition, an integral controller in the forward loop illustratively provides enhanced command tracking, low frequency disturbance rejection and an automatic trim capability.

{The Examiner may have meant 0390-0392. Otherwise the range is not credible}

[0390] In one aspect of the present invention, through GUI display 2622, an operator can maintain a variable level of control over a UAV, from fully manual to fully autonomous, with simple user-friendly inputs. For example, if an operator decides to divert a UAV to a new route, the operator has a plurality of options to select from. The following are examples of some of the options that an operator has. Those skilled in the art should recognize that this is not an exhaustive list. In one embodiment, the operator could graphically edit the existing route on mission situation display 2629 by adding a waypoint or orbit pattern in the vicinity of a desired target region. Prior to accepting the edited route, the control system evaluates the revised route against the vehicle performance capability as well as terrain obstructions. If the route is within acceptable bounds, the control system registers the modified route and maneuvers the vehicle accordingly. In another embodiment, the operator could select a park mode on selections pane 2630. After selected, the control system queues the operator to click the location of and graphical size (via a mouse) the desired orbit pattern in which the vehicle will fly while "parked" over a desired target. In another embodiment, the operator can select a manual control mode on selections pane 2630. By selecting RDC (remote directional command), for example, the control system



controls the UAV into a constant altitude, heading and speed flight until the operator instructs a maneuver. While in RDC mode, the operator can either pseudo-manually direct the UAV using the control stick (e.g. joystick) or the operator can program a fixed heading, altitude and speed using the control options provided in selections pane 2630.

[0391] The described Intelligent displays with smart variables represent an effective approach to actively displaying information for different types of vehicles. However, a problem can arise when a new vehicle is integrated into the ground control station with a completely foreign command and control interface. Under these circumstances, the ground control station is not concerned about displaying data, but is tasked to provide a command and control interface for the operator to perform the required operations. This conundrum is the motivation for another embodiment of the present invention, namely, the integration of vehicle specific panels in the ground control station.

[0392] In one embodiment, a generic vehicle class (GVC) is illustratively a software component that provides a rapid development environment API to add new vehicle classes and types to the ground control station. The GVC also illustratively serves as a software construct that allows the inclusion of multiple vehicles within the ground control station framework. One of the variables in the application is a vector of pointers to a generic vehicle class. This list is constructed by allocating new specific vehicles and returning a type case to the base generic vehicle class. When a new vehicle is integrated into the ground control station, the

generic vehicle class provides all of the virtual functions to integrate with system control components (e.g., to integrate with a map display, a communications package, PCIG imagery and/or appropriate display windows). An important object in the application framework is illustratively a pointer to the current vehicle generic class. When the user switches vehicles, this pointer is updated and all displays grab the appropriate smart variables from the pointer to the new base class. This is the mechanism by which windows immediately update to the current vehicle information whenever the user switches vehicles. The default windows use the pointer to the current vehicle to grab information. In this manner, if the user switches to a new vehicle with a different set of datalink variables, that fact is immediately apparent on the display windows.

Therefore, it would have been obvious to one of ordinary skill in the art at the time the invention was made to modify Margolin as taught by Duggan for the purpose of incorporating an autopilot to ensure smooth transitions (Duggna abstract, sec 0014, 0085, 0086).

The different embodiments in both prior arts are combinable as it would be obvious to one of ordinary skill in the art.

**Abstract**

Embodiments are disclosed for a vehicle control system and related sub-components that together provide an operator with a plurality of specific modes of operation, wherein various modes of operation incorporate different levels of autonomous control. Through a control user interface, an operator can move between certain modes of control even after vehicle deployment. Specialized autopilot system components and methods are employed to ensure smooth transitions between

control modes. Empowered by the multi-modal control system, an operator can even manage multiple vehicles simultaneously.

[0014] Embodiments of the present invention pertain to a hierarchical control system, user interface system, and control architecture that together incorporate a broad range of user-selectable control modes representing variable levels of autonomy and vehicle control functionality. A unified autopilot is provided to process available modes and mode transitions. An intelligence synthesizer is illustratively provided to assist in resolving functional conflicts and transitioning between control modes, although certain resolutions and transitions can be incorporated directly into the functional sub-components associated with the different control modes. In accordance with one embodiment, all modes and transitions are funneled through an acceleration-based autopilot system. Accordingly, control commands and transitions are generally reduced to an acceleration vector to be processed by a centralized autopilot system.

[0085] As will be discussed in greater detail below, the control system and architecture embodiments of the present invention essentially enable any autopilot design to support control of a vehicle in numerous control modes that are executed with switches between modes during flight. All control modes are supported even in the presence of sensor errors, such as accelerometer and gyro biases. This robustness is at least partially attributable to the fact that the closed-loop system, in all control modes, is essentially slaved to an inertial path and, hence, the sensor biases wash out in the closed loop,

assuming the biases are not so grossly large that they induce stability problems in the autopilot system. Furthermore, winds are generally not an issue in the overall control scheme in that the flight control system will regulate to the inertial path, adjusting for winds automatically in the closed loop. Given the precision afforded by inertial navigation aided by GPS technology, inertial path regulation offers a highly effective and robust UAV control approach. Generally speaking, the autopilot system functions such that winds, medium Dryden turbulence levels, sensor errors, airframe aerodynamic and mass model parameter uncertainties, servo non-linearity (slew rate limits, etc.), and various other atmospheric and noise disturbances will non have a critically negative impact on flight path regulation.

[0086] Component 408 receives commands generated by component 404 and filtered by autopilot component 406. The commands received by component 408 are executed to actually manipulate the vehicle's control surfaces. Autopilot component 406 then continues to monitor vehicle stabilization and/or command tracking, making additional commands to component 408 as necessary.

1  
2 At the beginning of this subsection, the Examiner asserts, “Margolin did not disclose that the  
3 vehicle is flown using an autonomous control system. However, Duggan teach of a system for  
4 safely flying an unmanned aerial vehicle in civilian airspace comprising: ...”

5  
6 The Examiner’s statement, “However, Duggan teach of a system for safely flying an unmanned  
7 aerial vehicle in civilian airspace comprising: ...” is conclusory and is not supported by the  
8 Examiner’s citations to Duggan.

9

1 In addition, none of the Duggan citations teach the limitations in Applicant's Claim 8 that either  
2 synthetic vision or Duggan's Variable Autonomy System comprises the step of:

3 (a) using a remote pilot to fly said unmanned aerial vehicle using synthetic vision during at  
4 least selected phases of the flight of said unmanned aerial vehicle, and during those phases of  
5 the flight of said unmanned aerial vehicle when said synthetic vision system is not used to  
6 control said unmanned aerial vehicle an autonomous control system is used to fly said  
7 unmanned aerial vehicle;

8

9 Duggan fails to teach the limitation that his Variable Autonomy System is used during selected  
10 phases of a UAV's flight and Margolin '724 fails to teach the limitation that synthetic vision is used  
11 during selected phases of a UAV's flight. Therefore, the combination of Duggan and Margolin '724  
12 does not read on Applicant's Claim 8.

13

14 As cited above by Applicant, MPEP 2143.03 "**All Claim Limitations must be Considered**" states:  
15 "all words in a claim must be considered in judging the patentability of that claim against the prior  
16 art." *In re Wilson*, 424 F.2d 1382, 1385, 165 USPQ 494, 496 (CCPA 1970)."

17

18 The Examiner has failed his duty under MPEP 2143.03 (and in view of *Wehling*) to present a *prima*  
19 *facie* case of obviousness for rejecting Applicant's Claim 8.

20

21 **Examiner's Regarding Claim 9**, a claim dependent on Claim 8. Applicant has shown that Claim 8  
22 is nonobvious. Therefore, under **2143.03 All Claim Limitations Must Be Considered**, Claim 9 is  
23 non-obvious.

24 **2143.03 All Claim Limitations Must Be ~~\*\*>~~Considered< [R-6]**

25 **\*\*** "All words in a claim must be considered in judging the patentability of that claim against  
26 the prior art." *In re Wilson*, 424 F.2d 1382, 1385, 165 USPQ 494, 496 (CCPA 1970). If an  
27 independent claim is nonobvious under 35 U.S.C. 103, then any claim depending therefrom is  
28 nonobvious. *In re Fine*, 837 F.2d 1071, 5 USPQ2d 1596 (Fed. Cir. 1988).

29

30 **Examiner's Regarding Claim 10**, a claim dependent on Claim 8. Applicant has shown that Claim  
31 8 is nonobvious. Therefore, under **2143.03 All Claim Limitations Must Be Considered**, Claim 10  
32 is non-obvious.

1 **2143.03 All Claim Limitations Must Be ~~\*\*>Considered<~~ [R-6]**

2 \*\* "All words in a claim must be considered in judging the patentability of that claim against  
3 the prior art." *In re Wilson*, 424 F.2d 1382, 1385, 165 USPQ 494, 496 (CCPA 1970). If an  
4 independent claim is nonobvious under 35 U.S.C. 103, then any claim depending therefrom is  
5 nonobvious. *In re Fine*, 837 F.2d 1071, 5 USPQ2d 1596 (Fed. Cir. 1988).

6  
7 **Examiner's Regarding Claim 11**, a claim dependent on Claim 8. Applicant has shown that Claim  
8 8 is nonobvious. Therefore, under **2143.03 All Claim Limitations Must Be Considered**, Claim 11  
9 is non-obvious.

10 **2143.03 All Claim Limitations Must Be ~~\*\*>Considered<~~ [R-6]**

11 \*\* "All words in a claim must be considered in judging the patentability of that claim against  
12 the prior art." *In re Wilson*, 424 F.2d 1382, 1385, 165 USPQ 494, 496 (CCPA 1970). If an  
13 independent claim is nonobvious under 35 U.S.C. 103, then any claim depending therefrom is  
14 nonobvious. *In re Fine*, 837 F.2d 1071, 5 USPQ2d 1596 (Fed. Cir. 1988).

15  
16 **Examiner:**

Regarding claim 12, Margolin (abstract; figs. 1-7; col. 3, lines 8-67; col. 4, lines 1-67; col. 5, lines 1-67) in view of Duggan disclose a method for safely flying an unmanned aerial vehicle as part of a unmanned aerial system equipped with a synthetic vision system in civilian airspace comprising the steps of:

- (a) using a remote pilot to fly said unmanned aerial vehicle using synthetic vision during at least selected phases of the flight of said unmanned aerial vehicle, and during those phases of the flight of said unmanned aerial vehicle when said synthetic vision system is not used to control said unmanned aerial vehicle an autonomous control system is used to fly said unmanned aerial vehicle;
- (b) providing a system onboard said unmanned aerial vehicle for detecting the presence and position of nearby aircraft and communicating this information to said remote pilot;

whereas said selected phases of the flight of said unmanned aerial vehicle comprise:

- (a) when said unmanned aerial vehicle is within a selected range of an airport or other designated location and is below a first specified altitude;

(b) when said unmanned aerial vehicle is outside said selected range of an airport or other designated location and is below a second specified altitude.

1

**2 Applicant:**

3 In Margolin '724: Column 3, lines 8-67; Column 4, lines 1-67; and Column 5, lines 1-67 form a  
4 continuous passage from Column 3, line 8 to Column 5, line 67. This passage of approximately  
5 1619 words forms the core of the Margolin '724 DETAILED DESCRIPTION. The remainder of the  
6 Margolin '724 DETAILED DESCRIPTION teaches additional topics such as **Flight Control** (with  
7 headings *Flight Control*, *Direct Control Non-Remotely Piloted Vehicles*, *Computer Mediated Non-*  
8 *Remotely Piloted Vehicles*, *Second Order Flight Control Mode*, *First Order Flight Control Mode*  
9 {See Column 6, line 19 - Column 8, line 3}, the features of a Control Panel (See Column 8, line 64  
10 - Column 9, line 18}, the use of a Head-Mounted Display {See Column 9, lines 19 - 32}, the use of  
11 the invention for training {See Column 9, lines 33 - 63}, and **The Database** {See Column 9, line 64  
12 - Column 10, line 50.}

13

14 The Examiner cites Figures 1 - 7 in Margolin '724. These constitute all the figures in Margolin  
15 '724.

16

17 The Examiner also cites the Abstract in Margolin '724. According to **608.01(b) Abstract of the**

**18 Disclosure [R-7]:****19 37 CFR 1.72 Title and abstract.**

20 \*\*\*\*\*

21 (b) A brief abstract of the technical disclosure in the specification must commence on a  
22 separate sheet, preferably following the claims, under the heading "Abstract" or "Abstract of  
23 the Disclosure." The sheet or sheets presenting the abstract may not include other parts of the  
24 application or other material. The abstract in an application filed under 35 U.S.C. 111 may not  
25 exceed 150 words in length. The purpose of the abstract is to enable the United States Patent  
26 and Trademark Office and the public generally to determine quickly from a cursory inspection  
27 the nature and gist of the technical disclosure.<

28

29 {Emphasis added}

30

1 The popular interpretation of 608.01(b) is that the purpose of the Abstract is to provide search  
2 terms. In any event, the Abstract in Margolin '724 does not say anything about civilian airspace.

3  
4 The Examiner has made a conclusory statement by repeating the title of Applicant's invention  
5 (leaving out the words "and method") and citing the core of the DETAILED DESCRIPTION in  
6 Margolin '724.

7  
8 In the remaining sections of the Examiner's rejection of Applicant's Claim 8 he asserts that he has  
9 found the elements and limitations of Applicant's invention.

10  
11 (a) using a remote pilot to fly said unmanned aerial vehicle using synthetic vision during at  
12 least selected phases of the flight of said unmanned aerial vehicle, and during those phases of  
13 the flight of said unmanned aerial vehicle when said synthetic vision system is not used  
14 to control said unmanned aerial vehicle an autonomous control system is used to fly said  
15 unmanned aerial vehicle;

16 (b) providing a system onboard said unmanned aerial vehicle for detecting the presence and  
17 position of nearby aircraft and communicating this information to said remote pilot;

18  
19 whereas said selected phases of the flight of said unmanned aerial vehicle comprise:

20 (a) when said unmanned aerial vehicle is within a selected range of an airport or other  
21 designated location and is below a first specified altitude;

22 (b) when said unmanned aerial vehicle is outside said selected range of an airport or other  
23 designated location and is below a second specified altitude.

24  
25 The Examiner has not even attempted to show where these limitations are taught in Margolin '724.  
26 He has particularly failed to show where the following is taught:

27 (a) using a remote pilot to fly said unmanned aerial vehicle using synthetic vision during at  
28 least selected phases of the flight of said unmanned aerial vehicle, and during those phases of  
29 the flight of said unmanned aerial vehicle when said synthetic vision system is not used  
30 to control said unmanned aerial vehicle an autonomous control system is used to fly said  
31 unmanned aerial vehicle;

32



1 and

2 whereas said selected phases of the flight of said unmanned aerial vehicle comprise:

3 (a) when said unmanned aerial vehicle is within a selected range of an airport or other  
4 designated location and is below a first specified altitude;

5 (b) when said unmanned aerial vehicle is outside said selected range of an airport or other  
6 designated location and is below a second specified altitude.

7  
8 As noted, he has cited the core of the Margolin '724 DETAILED DESCRIPTION, all of the  
9 drawings, and the abstract. His rejection is purely conclusory and does not follow the requirements  
10 for making a *prima facie* rejection required by MPEP § 2143.03 **All Claim Limitations Must Be**  
11 **Considered**, *KSR*, and *Wehling*, as well as MPEP § 2142 **ESTABLISHING A PRIMA FACIE**  
12 **CASE OF OBVIOUSNESS**.

13

14 The Examiner continues:

15 *Margolin did not disclose that the vehicle is flown using an autonomous control system.*  
16 *However, Duggan teach of a system for safely flying an unmanned aerial vehicle in civilian*  
17 *airspace comprising:*

18 *a ground station controlling an unmanned aerial vehicle (sec. 0352, 00353), wherein*  
19 *during phases of a flight of an unmanned aerial vehicle (UAV, sec 0318, 0322, 0353) when a*  
20 *synthetic vision (sec. 0356, 0365, 0388, 0390) is not used to control said unmanned aerial*  
21 *vehicle said unmanned aerial vehicle is flown using an autonomous control system (autopilot,*  
22 *sec 0346 to 0350, 0390-0329).*

23 *Therefore, it would have been obvious to one of ordinary skill in the art at the time the*  
24 *invention was made to modify Margolin as taught by Duggan for the purpose of incorporating*  
25 *an autopilot to ensure smooth transitions (Duggna abstract, sec 0014, 0085, 0086).*

26 *The different embodiments in both prior arts are combinable as it would be obvious to ne*  
27 *having ordinary skill in the art.*

28

<u>Examiner</u>	<u>Duggan</u>
Margolin did not disclose that the	[0352] In one aspect of the present invention, an operator

<p>vehicle is flown using an autonomous control system. However, Duggan teach of a system for safely flying an unmanned aerial vehicle in civilian airspace comprising: a ground station controlling an unmanned aerial vehicle (sec. 0352, 00353),</p> <p>wherein during phases of a flight of an unmanned aerial vehicle (UAV, sec 0318,</p>	<p>station (also referred to as the ground control station or GCS) is designed to accommodate command and control of multiple vehicles or a single vehicle by a single operator. In accordance with one embodiment, the ground control station is platform independent and implements an application program interface that provides windowing and communications interfaces (e.g., the platform is implemented in Open Source wxWindows API). The underlying operating system is illustratively masked and enables a developer to code in a high level environment.</p> <p>[0353] In one embodiment, the ground control station incorporates several specialized user interface concepts designed to effectively support a single operator tasked to control multiple vehicles. The GCS also illustratively supports manual control and sensor steering modes. In the manual control mode, the operator can assume control authority of the vehicles individually from the ground control station at any time in flight. In the sensor steering mode, a vehicle will autonomously fly in the direction the operator is manually pointing the on-board imaging sensor (e.g., operator views video output from a digital camera on a TV interface, computer screen display, etc.). A custom data link is illustratively, utilized to support a two-way transfer of data between the ground control station and the UAV's. These design concepts together provide a flexible, multiple vehicle control system. The details of the concepts are discussed below.</p> <p>[0318] If the pilot chooses a surveillance location outside the total FOV, then the outer loop guidance will illustratively</p>
--	--

0322,	<p>follow a command-to-LOS mode guide law until the UAV flight path points toward the target. Once the desired starting-point comes within a minimum range threshold, the guidance automatically trips into a loiter pattern (either constant-radius or elliptical) to maintain a station with a single key-click while he/she conducts other activities. FIGS. 22A &amp; 22B together demonstrate the surveillance-point approach scenario.</p> <p>[0322] In accordance with one aspect of the present invention, sensor-slave mode commands are generated by an autonomous line-of-sight driven function, in which the command objectives are generated by the necessities of the function rather than by an operator. For example, a function designed to command a raster-scan of a particular surveillance area, or a function designed to scan a long a roadway could be used to generate sensor slave commands. Another example is a function designed to generate line-of-sight commands for UAV-to-UAV rendezvous formation flying.</p>
0353)	<p>[0353] In one embodiment, the ground control station incorporates several specialized user interface concepts designed to effectively support a single operator tasked to control multiple vehicles. The GCS also illustratively supports manual control and sensor steering modes. In the manual control mode, the operator can assume control authority of the vehicles individually from the ground control station at any time in flight. In the sensor steering mode, a vehicle will autonomously fly in the direction the operator is manually pointing the on-board imaging sensor (e.g., operator views video output from a digital camera on a TV interface, computer screen display, etc.). A custom data link is</p>

	<p>illustratively, utilized to support a two-way transfer of data between the ground control station and the UAV's. These design concepts together provide a flexible, multiple vehicle control system. The details of the concepts are discussed below.</p>
when a synthetic vision (sec. 0356,	[0356] a synthetic vision display
0365,	[0365] The two video monitors are illustratively used to display real-time data linked camera imagery from two air vehicles having cameras (of course, fewer, more or none of the vehicles might have cameras and the number of monitor displays can be altered accordingly). In accordance with one embodiment, camera imagery is recorded on videotapes during a mission. In accordance with one embodiment, the two repeater displays are used to provide redundant views of the GUI and synthetic vision display. The laptop illustratively serves as a GUI backup in the event that the main GUI fails.
0388,	[0388] In one aspect of the present invention, synthetic vision display technical approach of the present invention is based upon integrating advanced simulated visuals, originally developed for training purposes, into UAV operational systems. In accordance with one embodiment, the simulated visuals are integrated with data derived from the ground control station during flight to enable real-time synthetic visuals.
0390) is not used to control said unmanned aerial vehicle said unmanned aerial vehicle is flown	[0390] In one aspect of the present invention, through GUI display 2622, an operator can maintain a variable level of control over a UAV, from fully manual to fully autonomous,

<p>using an autonomous control system</p> <p>(autopilot, sec 0346 to 0350,</p>	<p>with simple user-friendly inputs. For example, if an operator decides to divert a UAV to a new route, the operator has a plurality of options to select from. The following are examples of some of the options that an operator has. Those skilled in the art should recognize that this is not an exhaustive list. In one embodiment, the operator could graphically edit the existing route on mission situation display 2629 by adding a waypoint or orbit pattern in the vicinity of a desired target region. Prior to accepting the edited route, the control system evaluates the revised route against the vehicle performance capability as well as terrain obstructions. If the route is within acceptable bounds, the control system registers the modified route and maneuvers the vehicle accordingly. In another embodiment, the operator could select a park mode on selections pane 2630. After selected, the control system queues the operator to click the location of and graphical size (via a mouse) the desired orbit pattern in which the vehicle will fly while "parked" over a desired target. In another embodiment, the operator can select a manual control mode on selections pane 2630. By selecting RDC (remote directional command), for example, the control system controls the UAV into a constant altitude, heading and speed flight until the operator instructs a maneuver. While in RDC mode, the operator can either pseudo-manually direct the UAV using the control stick (e.g. joystick) or the operator can program a fixed heading, altitude and speed using the control options provided in selections pane 2630.</p> <p>[0346] In accordance with one embodiment, an exemplary translation layer implementation will now be provided. After the guidance algorithms execute, the outputs are translated to</p>
--	---

the native vehicle autopilot commands. The equations below provide example kinematic translations from the guidance acceleration commands to native vehicle autopilot commands. These equations demonstrate the principal that vehicle motion is activated through acceleration. The methods that various vehicles employ to generate acceleration are numerous (bank angle autopilot, acceleration autopilot, heading control autopilot, altitude control autopilot, etc). Since the control algorithms described herein generate acceleration commands that can be kinematically translated into any of these native autopilot commands, the guidance algorithms truly provide a generalized library of control laws that can control any vehicle through that vehicle's native atomic functions. Ubiquitous acceleration control techniques enable VACS to synthesize control commands for any vehicle, including air, ground, or sea-based.

$a_v$  = vertical plane acceleration command  
 $a_h$  = horizontal plane acceleration command  
 $\theta = \tan^{-1} \left( \frac{a_h}{a_v} \right)$  = bank angle command  
 $a_T = \sqrt{a_v^2 + a_h^2}$  = total body acceleration command  
 $\dot{\theta} = \frac{a_h}{V}$  = turn rate command  
 $i = i - 1 + \dot{\theta} \cdot t$  = heading command  
 $\dot{\theta} = \left( \frac{a_v - g}{V} \right)$  = flight path rate command  
 $i = i - 1 + \dot{\theta} \cdot t$  = flight path angle command  
 $h \cdot \dot{\theta} = V \sin(\theta)$  = climb rate command  
 $\dot{h} = \dot{h} = 1 + h \cdot \dot{\theta}$  = altitude command Eq . 57

[0347] Additional functionality that can be enabled in a translation layer is means for discouraging or preventing an operator (e.g., the human or non-human operator interfacing the VACS architecture) from overdriving, stalling, or spinning the vehicle frame. This being said, limiting algorithms can also be employed in the guidance or autopilot functions.

[0348] X. Autopilot

[0349] As has been addressed, the present invention is not limited to, and does not require, a particular autopilot system. The control system and architecture embodiments of the present invention can be adapted to accommodate virtually any autopilot system.

[0350] For the purpose of providing an example, an illustrative suitable autopilot software system will now be described. The illustrative autopilot system incorporates a three-axis design (pitch and yaw with an attitude control loop in the roll axis) for vehicle stabilization and guidance command tracking. The autopilot software design incorporates flight control techniques, which allow vehicle control algorithms to dynamically adjust airframe stabilization parameters in real-time during flight. The flight computer is programmed directly with the airframe physical properties, so that it can automatically adjust its settings with changes in airframe configuration, aerodynamic properties, and/or flight state. This provides for a simple and versatile design, and possesses the critical flexibility needed when adjustments to the airframe configuration become necessary. The three-loop design includes angular rate feedback for stability augmentation, attitude feedback for closed-loop stiffness, and acceleration feedback for command tracking. In addition, an integral controller in the forward loop illustratively provides enhanced command tracking, low frequency disturbance rejection and an automatic trim capability.

0390-0329).

{The Examiner may have meant 0390-0392. Otherwise the

range is not credible}

[0390] In one aspect of the present invention, through GUI display 2622, an operator can maintain a variable level of control over a UAV, from fully manual to fully autonomous, with simple user-friendly inputs. For example, if an operator decides to divert a UAV to a new route, the operator has a plurality of options to select from. The following are examples of some of the options that an operator has. Those skilled in the art should recognize that this is not an exhaustive list. In one embodiment, the operator could graphically edit the existing route on mission situation display 2629 by adding a waypoint or orbit pattern in the vicinity of a desired target region. Prior to accepting the edited route, the control system evaluates the revised route against the vehicle performance capability as well as terrain obstructions. If the route is within acceptable bounds, the control system registers the modified route and maneuvers the vehicle accordingly. In another embodiment, the operator could select a park mode on selections pane 2630. After selected, the control system queues the operator to click the location of and graphical size (via a mouse) the desired orbit pattern in which the vehicle will fly while "parked" over a desired target. In another embodiment, the operator can select a manual control mode on selections pane 2630. By selecting RDC (remote directional command), for example, the control system controls the UAV into a constant altitude, heading and speed flight until the operator instructs a maneuver. While in RDC mode, the operator can either pseudo-manually direct the UAV using the control stick (e.g. joystick) or the operator can program a fixed heading, altitude and speed using the control options provided in selections pane 2630.



[0391] The described Intelligent displays with smart variables represent an effective approach to actively displaying information for different types of vehicles. However, a problem can arise when a new vehicle is integrated into the ground control station with a completely foreign command and control interface. Under these circumstances, the ground control station is not concerned about displaying data, but is tasked to provide a command and control interface for the operator to perform the required operations. This conundrum is the motivation for another embodiment of the present invention, namely, the integration of vehicle specific panels in the ground control station.

[0392] In one embodiment, a generic vehicle class (GVC) is illustratively a software component that provides a rapid development environment API to add new vehicle classes and types to the ground control station. The GVC also illustratively serves as a software construct that allows the inclusion of multiple vehicles within the ground control station framework. One of the variables in the application is a vector of pointers to a generic vehicle class. This list is constructed by allocating new specific vehicles and returning a type case to the base generic vehicle class. When a new vehicle is integrated into the ground control station, the generic vehicle class provides all of the virtual functions to integrate with system control components (e.g., to integrate with a map display, a communications package, PCIG imagery and/or appropriate display windows). An important object in the application framework is illustratively a pointer to the current vehicle generic class. When the user switches vehicles, this pointer is updated and all displays grab the

<p>Therefore, it would have been obvious to one of ordinary skill in the art at the time the invention was made to modify Margolin as taught by Duggan for the purpose of incorporating an autopilot to ensure smooth transitions (Duggna abstract, sec 0014, 0085, 0086).</p> <p>The different embodiments in both prior arts are combinable as it would be obvious to ne[sic] having ordinary skill in the art.</p>	<p>appropriate smart variables from the pointer to the new base class. This is the mechanism by which windows immediately update to the current vehicle information whenever the user switches vehicles. The default windows use the pointer to the current vehicle to grab information. In this manner, if the user switches to a new vehicle with a different set of datalink variables, that fact is immediately apparent on the display windows.</p> <p><b>Abstract</b></p> <p>Embodiments are disclosed for a vehicle control system and related sub-components that together provide an operator with a plurality of specific modes of operation, wherein various modes of operation incorporate different levels of autonomous control. Through a control user interface, an operator can move between certain modes of control even after vehicle deployment. Specialized autopilot system components and methods are employed to ensure smooth transitions between control modes. Empowered by the multi-modal control system, an operator can even manage multiple vehicles simultaneously.</p> <p>[0014] Embodiments of the present invention pertain to a hierarchical control system, user interface system, and control architecture that together incorporate a broad range of user-</p>
---	---

selectable control modes representing variable levels of autonomy and vehicle control functionality. A unified autopilot is provided to process available modes and mode transitions. An intelligence synthesizer is illustratively provided to assist in resolving functional conflicts and transitioning between control modes, although certain resolutions and transitions can be incorporated directly into the functional sub-components associated with the different control modes. In accordance with one embodiment, all modes and transitions are funneled through an acceleration-based autopilot system. Accordingly, control commands and transitions are generally reduced to an acceleration vector to be processed by a centralized autopilot system.

[0085] As will be discussed in greater detail below, the control system and architecture embodiments of the present invention essentially enable any autopilot design to support control of a vehicle in numerous control modes that are executed with switches between modes during flight. All control modes are supported even in the presence of sensor errors, such as accelerometer and gyro biases. This robustness is at least partially attributable to the fact that the closed-loop system, in all control modes, is essentially slaved to an inertial path and, hence, the sensor biases wash out in the closed loop, assuming the biases are not so grossly large that they induce stability problems in the autopilot system. Furthermore, winds are generally not an issue in the overall control scheme in that the flight control system will regulate to the inertial path, adjusting for winds automatically in the closed loop. Given the precision afforded by inertial navigation aided by GPS technology, inertial path regulation offers a highly effective

and robust UAV control approach. Generally speaking, the autopilot system functions such that winds, medium Dryden turbulence levels, sensor errors, airframe aerodynamic and mass model parameter uncertainties, servo non-linearity (slew rate limits, etc.), and various other atmospheric and noise disturbances will non have a critically negative impact on flight path regulation.

[0086] Component 408 receives commands generated by component 404 and filtered by autopilot component 406. The commands received by component 408 are executed to actually manipulate the vehicle's control surfaces. Autopilot component 406 then continues to monitor vehicle stabilization and/or command tracking, making additional commands to component 408 as necessary.

1  
2  
3  
4  
5  
6  
7  
8  
9  
10  
11  
12  
13  
14  
15  
16  
17  
18

At the beginning of this subsection, the Examiner asserts, “Margolin did not disclose that the vehicle is flown using an autonomous control system. However, Duggan teach of a system for safely flying an unmanned aerial vehicle in civilian airspace comprising: ...”

The Examiner’s statement, “However, Duggan teach of a system for safely flying an unmanned aerial vehicle in civilian airspace comprising: ...” is conclusory and is not supported by the Examiner’s citations to Duggan.

In addition, none of the Duggan citations teach the limitations in Applicant’s Claim 12 that either synthetic vision or Duggan’s Variable Autonomy System comprises the step of:

- (a) using a remote pilot to fly said unmanned aerial vehicle using synthetic vision during at least selected phases of the flight of said unmanned aerial vehicle, and during those phases of the flight of said unmanned aerial vehicle when said synthetic vision system is not used to control said unmanned aerial vehicle an autonomous control system is used to fly said unmanned aerial vehicle;

and

1 whereas said selected phases of the flight of said unmanned aerial vehicle comprise:

2 (a) when said unmanned aerial vehicle is within a selected range of an airport or other  
3 designated location and is below a first specified altitude;

4 (b) when said unmanned aerial vehicle is outside said selected range of an airport or other  
5 designated location and is below a second specified altitude.  
6

7 Duggan fails to teach the limitation that his Variable Autonomy System is used during selected  
8 phases of a UAV's flight and Margolin '724 fails to teach the limitation that synthetic vision is used  
9 during selected phases of a UAV's flight. Therefore, the combination of Duggan and Margolin '724  
10 does not read on Applicant's Claim 12.  
11

12 As cited above by Applicant, MPEP 2143.03 "**All Claim Limitations must be Considered**" states:  
13 "all words in a claim must be considered in judging the patentability of that claim against the prior  
14 art." *In re Wilson*, 424 F.2d 1382, 1385, 165 USPQ 494, 496 (CCPA 1970)."  
15

16 The Examiner has failed his duty under MPEP 2143.03 (and in view of *Wehling*) to present a *prima*  
17 *facie* case of obviousness for rejecting Applicant's Claim 12.  
18

19 **Examiner's Regarding Claim 13**, a claim dependent on Claim 12. Applicant has shown that Claim  
20 12 is nonobvious. Therefore, under **2143.03 All Claim Limitations Must Be Considered**, Claim  
21 13 is non-obvious.

22 **2143.03 All Claim Limitations Must Be ~~\*\*\*>Considered<~~ [R-6]**

23 **\*\*** "All words in a claim must be considered in judging the patentability of that claim against  
24 the prior art." *In re Wilson*, 424 F.2d 1382, 1385, 165 USPQ 494, 496 (CCPA 1970). If an  
25 independent claim is nonobvious under 35 U.S.C. 103, then any claim depending therefrom is  
26 nonobvious. *In re Fine*, 837 F.2d 1071, 5 USPQ2d 1596 (Fed. Cir. 1988).  
27

28 **Examiner's Regarding Claim 14**, a claim dependent on Claim 12. Applicant has shown that Claim  
29 12 is nonobvious. Therefore, under **2143.03 All Claim Limitations Must Be Considered**, Claim  
30 14 is non-obvious.

31 **2143.03 All Claim Limitations Must Be ~~\*\*\*>Considered<~~ [R-6]**

1       \*\* "All words in a claim must be considered in judging the patentability of that claim against  
2       the prior art." *In re Wilson*, 424 F.2d 1382, 1385, 165 USPQ 494, 496 (CCPA 1970). If an  
3       independent claim is nonobvious under 35 U.S.C. 103, then any claim depending therefrom is  
4       nonobvious. *In re Fine*, 837 F.2d 1071, 5 USPQ2d 1596 (Fed. Cir. 1988).

5  
6       **Part B - The Present Applicant is the named inventor on 5,904,724.**

7       The present Applicant (Jed Margolin) is the named inventor on U.S. Patent 5,904,724. See the  
8       attached DECLARATION OF JED MARGOLIN. The Examiner is barred from citing '724 as prior  
9       art in a 35 U.S.C. §103 rejection. *See ISCO INTERN v. Conductus, Inc*, 279 F.Supp.2d 489 (D.Del.  
10      2003) Footnote 4:

11       [4] Although § 102 relates to prior invention by another, anticipation, and abandonment, its  
12       standard for determining prior art is applied to the § 103 obviousness inquiry as well. *See, e.g.,*  
13       *Panduit Corp. v. Dennison Mfg. Co.*, 810 F.2d 1561, 1568 (Fed.Cir.1987), *cert. denied*, 481  
14       U.S. 1052, 107 S.Ct. 2187, 95 L.Ed.2d 843 (1987) ("Before answering *Graham's* `content'  
15       inquiry, it must be known whether a patent or publication is in the prior art under 35 U.S.C. §  
16       102.") (citing *Graham v. John Deere Co.*, 383 U.S. 1, 86 S.Ct. 684, 15 L.Ed.2d 545 (1966)); *Ex*  
17       *parte Andresen*, 212 U.S.P.Q. 100, 102 (Pat.& Tr. Office Bd.App. 1981) (citing congressional  
18       committee record and commentary and concluding that Congress intended § 103 to "includ[e]  
19       all of the various bars to a patent as set forth in section 102").

20  
21      As MPEP 2129 explains, "However, even if labeled as "prior art," the work of the same inventive  
22      entity may not be considered prior art against the claims unless it falls under one of the statutory  
23      categories."

24      **2129 Admissions as Prior Art [R-6]**

25      **I. ADMISSIONS BY APPLICANT CONSTITUTE PRIOR ART**

26      A statement by an applicant >in the specification or made< during prosecution identifying the  
27      work of another as "prior art" is an admission \*\*>which can be relied upon for both  
28      anticipation and obviousness determinations, regardless of whether the admitted prior art would

1 otherwise qualify as prior art under the statutory categories of 35 U.S.C. 102. *Riverwood Int'l*  
2 *Corp. v. R.A. Jones & Co.*, 324 F.3d 1346, 1354, 66 USPQ2d 1331, 1337 (Fed. Cir. 2003);  
3 *Constant v. Advanced Micro-Devices Inc.*, 848 F.2d 1560, 1570, 7 USPQ2d 1057, 1063 (Fed.  
4 Cir. 1988).< However, even if labeled as "prior art," the work of the same inventive entity may  
5 not be considered prior art against the claims unless it falls under one of the statutory  
6 categories. *Id.*; see also *Reading & Bates Construction Co. v. Baker Energy Resources Corp.*,  
7 748 F.2d 645, 650, 223 USPQ 1168, 1172 (Fed. Cir. 1984) ("[W]here the inventor continues to  
8 improve upon his own work product, his foundational work product should not, without a  
9 statutory basis, be treated as prior art solely because he admits knowledge of his own work. It is  
10 common sense that an inventor, regardless of an admission, has knowledge of his own work.").

11 Consequently, the examiner must determine whether the subject matter identified as "prior art"  
12 is applicant's own work, or the work of another. In the absence of another credible explanation,  
13 examiners should treat such subject matter as the work of another.

14  
15 **Part D - Applicant's invention meets a long felt but unmet need.**

16 According to the article **NASA Plans UAS Push** (Exhibit 1 at 81):

17 NASA is seeking industry feedback on its plans for a new five-year, \$150-million program to  
18 help integrate unmanned aircraft into civil airspace. The feedback is likely to be mixed, as the  
19 agency's last major unmanned aircraft research program was canceled before it got off the  
20 ground, despite industry backing.

21  
22 Briefed to industry experts in early August, the Unmanned Air Systems (UAS) Integration in  
23 the National Airspace System (NAS) project is planned to begin in Fiscal 2011. It would be  
24 NASA's first major unmanned aircraft effort since the High-Altitude Long-Endurance Remotely  
25 Operated Aircraft (HALE ROA) project was killed in 2005.

26  
27 The new program would focus on separation assurance and collision avoidance, pilot-aircraft  
28 interface, certification requirements and communications, involving a series of increasingly  
29 complex flight demonstrations. The main goal is to generate data to help the FAA and

1 standards organizations develop guidelines and regulations for the design and operation of  
2 UASs in the NAS. The research is expected to have an impact in the 2015-25 timeframe.

3  
4 Applicant's invention solves a long-felt unmet need to safely fly UAVs in civilian airspace. (See  
5 MPEP 716.04 **Long-Felt Need and Failure of Others.**) Otherwise it would not be necessary for  
6 NASA to set up "a new five-year, \$150-million program to help integrate unmanned aircraft into  
7 civilian airspace."

8  
9 **Part E - The Duggan Application.**

10 The Examiner's choice of Duggan Patent Application US 2005004723 as a reference is interesting.  
11 By a coincidence Applicant ("Margolin") discovered the Duggan Application not long after the  
12 USPTO published it.

13  
14 Margolin analyzed the Dugan claims and found some deficiencies. For example, Duggan Claim 1:

15  
16 1. A computer-implemented method for providing an operator of a vehicle with a plurality of  
17 control modes, wherein the system is configured to support transitioning between control  
18 modes during operation of the vehicle, the method comprising: receiving a first operator input  
19 that corresponds to a first control mode; generating a first directional representation of the first  
20 operator input; processing the first directional representation through a unified autopilot system  
21 so as to generate a first control output; mechanically adjusting a control component associated  
22 with the vehicle based on the first control output; receiving a second operator input that  
23 corresponds to a request to transition from the first control mode to a second control mode;  
24 transitioning from the first control mode to the second control mode; receiving a third operator  
25 input that corresponds to the second control mode; generating a second directional  
26 representation of the third operator input; processing the second directional representation  
27 through the unified autopilot system so as to generate a second control output; and  
28 mechanically adjusting a control component associated with the vehicle based on the second  
29 control output.

30 {Emphasis added}



1 This claims a method where the operator of a vehicle is able to select two or more control modes  
2 and the system transitions between them. The claim does not say how the system transitions  
3 between them other than that the autopilot does it. The term “directional representation” does not  
4 appear in the Specification. What is the “directional representation” of an operator input? Common  
5 English usage suggests that it is the line or course along which the operator moves the joystick or  
6 mouse. Also, by definition an autopilot mechanically adjusts control components so this part of the  
7 claim is redundant.

8  
9 Duggan’s Dependent claim 2 is redundant. Duggan’s Claim 1 already specifies the use of a unified  
10 autopilot.

11 2. The method of claim 1, wherein said transitioning comprises processing a transition  
12 command through the unified autopilot system.

13

14 Duggan Dependent claim 3:

15 3. The method of claim 1, wherein generating a first directional representation comprises  
16 generating a first set of acceleration and bank angle commands.

17

18 Finally, something real. A directional representation can be a set of acceleration and bank angle  
19 commands. What else can a “directional representation” be? Duggan does not teach it, so Claim 1 is  
20 indistinct.

21

22 Even so, this may have already been done. For example see U.S. Patent 4,155,525 **Maneuver**  
23 **detector circuit for use in autothrottle control systems having thrust and flight path control**  
24 **decoupling** issued May 22, 1979 to Peter-Contesse (assigned to Boeing). From Column 1, lines 15-  
25 28:

26 It is an object of this invention to provide a flight control system having thrust and flight path  
27 control decoupling utilizing maneuver detector and limited integrator circuit means in lieu of  
28 the aforementioned time-constant programmer circuit means.

29

30 It is yet another object of this invention to provide circuit means responsive to elevator, normal  
31 acceleration, and pitch attitude signals for providing a signal having a first predetermined  
32 polarity when a purposeful maneuver of the aircraft is effected and a further signal having a  
33 polarity opposite to said first predetermined polarity when a non-maneuver is indicated, a

1 purposeful maneuver being defined as one initiated by the pilot as contrasted to non-pilot  
2 initiated aircraft maneuvers.

3  
4 There is also U.S. Patent 6,062,513 **Total energy based flight control system** issued May 16, 2000  
5 to Lambregts (also assigned to Boeing). From Column 6, line 65 - Column 7, line 14:

6 The present invention modifies the known TEC system by using an alternate control strategy  
7 and flight path command  $\gamma$  processing scheme. This alternate strategy is used  
8 during manual control mode (using a control column or the like) when the thrust has been  
9 driven to a preset value (such as a maximum or minimum thrust limit) or when the automatic  
10 throttle is disengaged. Under these circumstances, instead of reverting to a pure path priority  
11 scheme for stick or control column inputs (by opening switch 30 and letting the airspeed  
12 increase or decreases until a speed limit is reached as is done in the known TEC system), the  
13 present invention transitions to a combined speed and path priority scheme, where flight path  
14 angle is the short term control priority and the set speed command is the long term priority. In  
15 this scheme, switch 30' remains closed and the normal speed control feedback is continued after  
16 thrust reaches a limit.

17  
18 Duggan Claim 31:

19 31. A multi-modal variable autonomy control system, the system comprising:

20  
21 a plurality of control mode components each corresponding to a different mode of control and  
22 being configured to respond to command inputs by generating directionally descriptive control  
23 commands; and

24  
25 a unified autopilot component for processing said directionally descriptive control commands.

26  
27 an vehicle control component for receiving processed commands from the unified autopilot  
28 system and actuating control devices accordingly.

29  
30 This claim contains inexcusable punctuation errors. These errors were not introduced by the Patent  
31 Office; they are in the Application in the File Wrapper. See Exhibit 2 at 83.

32

1 Margolin gave his analysis to Optima Technology, Inc. (now Optima Technology Group) who was  
2 then acting as Margolin's agent for selling or licensing his patents. Optima contacted Geneva  
3 Aerospace, the assignee of the Duggan application.

4  
5 Geneva responded by filing a Supplemental IDS listing all of Margolin's patents (even though only  
6 5,566,073 and 5,904,724 were relevant), U.S. Patents 4,155,525 and 6,062,513, along with some of  
7 the non-patent literature that Margolin had presented, such as:

8  
9 Beringer, D.; **Applying Performance-Controlled Systems, Fuzzy Logic, and Fly-By-Wire**  
10 **Controls to General Aviation**, Office of Aerospace Medicine, May 2002.

11  
12 Abernathy, M.; **"Virtual Cockpit Window" for a Windowless Aerospacecraft.**

13 <http://www.nasatech.com/Briefs/Jan03/MSC23096.html> Jan. 2003.

14  
15 See Exhibit 2 at 84-88.

16  
17 **Geneva also licensed Margolin Patents 5,566,073 and 5,904,724.** See Exhibit 3 at 91.

18  
19 It came as a complete surprise to Applicant when the Duggan Application was allowed as filed  
20 (despite its defects) in the FOAM. Geneva's attorneys may have been surprised as well. They had to  
21 ask the Duggan Examiner to correct the punctuation errors in Duggan Claim 31. See Exhibit 2 at 89.

22  
23 Perhaps the Duggan Examiner was preoccupied with financial problems. See Exhibit 4 at 109. But  
24 where were the Second Set of Eyes? Perhaps they were sleeping that day.

25  
26 Margolin wishes to note that the Examiner in the present case cited the Duggan Application even  
27 though it had already issued as U.S. Patent 7,343,232 ('232) **Vehicle control system including**  
28 **related methods and components** on March 11, 2008.

29  
30 The Duggan Application may have other problems as well. The Duggan Application claims priority  
31 from Provisional Application Ser. No. 60/480,192, filed Jun. 20, 2003. According to 35 U.S.C. 102  
32 **Conditions for patentability; novelty and loss of right to patent.**

33 A person shall be entitled to a patent unless -

34 \*\*\*\*\*

1 (b) the invention was patented or described in a printed publication in this or a foreign country  
2 or in public use or on sale in this country, more than one year prior to the date of application for  
3 patent in the United States.  
4

5 There is evidence that this might have occurred. The paper **UCAV Distributed Mission Training**  
6 **Testbed: Lessons Learned and Future Challenges** by Dr. Dutch Guckenberger and Matt Archer;  
7 The Interservice/Industry Training, Simulation & Education Conference (I/ITSEC), Volume: 2000  
8 (Conference Theme: Partnerships for Learning in the New Millennium) was presented at the  
9 I/ITSEC Conference in 2000. The title page and page 7 are reproduced in Exhibit 5 at 180. On  
10 document page 7 (Exhibit 5 at 183), under the heading **Variable Autonomy Control System**  
11 **(VACS)** it refers to Geneva Aerospace's Variable Autonomy Control System:

12  
13 As a portion of the DMT UCAV Testbed development, the **Geneva AeroSpace Variable**  
14 **Autonomy Control System (VACS) was added to LiteFlite. The VACS is designed to be**  
15 **effective for UAV and UCAV systems as usable to individuals whose training is focused**  
16 **on the requirements of a given mission or the usability of the payload, rather than on the**  
17 **aviation of the vehicle.** As the dependence on UAVs for military operations grows and UAV  
18 technology is integrated into the emerging global command and control architecture, the cost  
19 and complexity of managing and controlling these assets can easily become substantial. The  
20 VACS solution to this UAV control problem lies in the appropriate functional allocation  
21 between the human and the machine. By merging modern stand-off missile flight control,  
22 advanced aircraft flight control, and state-of-the-art communications technologies, **Geneva has**  
23 **developed a novel hierarchical flight control structure with varied levels of remote**  
24 **operator input to address the human-machine functional allocation problem.**

25  
26 **The VACS has been successfully demonstrated enabling a diverse range of users to**  
27 **effectively operate UAVs.** Furthermore, the VACS solution eliminates the requirement for  
28 UAVs to be controlled by highly trained, rated pilots. In a continuing development and  
29 demonstration effort VACS is to be used Joint STARS MTE workstation and the Freewing  
30 Scorpion 100-50 UAV and conduct a flight test demonstration. This program will demonstrate  
31 the benefits of the variable autonomy flight control system design with simplified manual  
32 control modes, demonstrate the compatibility of such a system with the military's emerging C4I

1 architecture, and demonstrate the synergism between Joint STARS and UAVs using the  
2 simplified UAV flight control technology.

3  
4 {Emphasis added}

5  
6 Geneva Aerospace filed a trademark application with the USPTO on 1/22/2004 for the trademark  
7 “Variable Autonomy Control System.” See Exhibit 6 at 185. In the application Geneva Aerospace  
8 declared, under penalty of perjury:

9  
10 The applicant, or the applicant's related company or licensee, is using the mark in commerce,  
11 and lists below the dates of use by the applicant, or the applicant's related company, licensee, or  
12 predecessor in interest, of the mark on or in connection with the identified goods and/or  
13 services. 15 U.S.C. Section 1051(a), as amended.

14  
15 International Class 009: computer software for autonomous aerial vehicle guidance and  
16 control systems

17  
18 In International Class 009, the mark was first used at least as early as 09/01/1998, **and first**  
19 **used in commerce at least as early as 09/01/1998**, and is now in use in such commerce. The  
20 applicant is submitting or will submit one specimen for each class showing the mark as used in  
21 commerce on or in connection with any item in the class of listed goods and/or services,  
22 consisting of a(n) Portion of company website describing product.

23  
24 {Emphasis added}

25  
26 The mark “Variable Autonomy Control System” is for “computer software for autonomous aerial  
27 vehicle guidance and control systems”.

28  
29 Geneva declares that the “Variable Autonomy Control System” was first used in commerce as early  
30 as 09/01/1998, which is more than one year prior to the 6/20/2003 filing date of the provisional  
31 application.

1 Is the “Variable Autonomy Control System” in the Duggan ‘232 patent the same “Variable  
2 Autonomy Control System” that Geneva wished to trademark? Their trademark application  
3 included a portion of the company website describing the product, which states (Exhibit 6 at 188):

4  
5 **Products: Variable Autonomy Control System (VACS)<sup>TM</sup>**

6  
7 **Under Air Force Research Lab funding** Geneva has developed an innovative UAV control  
8 design that combines state-of-the-art missile technologies with fixed-wing aircraft control. Our  
9 design balances autonomous flight control **With manual control to provide variable levels of**  
10 **directional independence** and minimizes the personnel and training requirements for the  
11 operation of the UAV, The truly enabled UAV operator is not required to be a trained aviator,  
12 but still retains a wide range of control flexibility in order to successfully execute the mission  
13 objectives that call upon his/her specialized expertise.

14  
15 **Our solution is a hierarchical flight control structure with multiple levels of remote**  
16 **operator input combined with an off-board controller software package and intuitive**  
17 **human system interface.** Research of the UAV control problem has indicated that the best  
18 solution lies in the appropriate functional allocation between the human and the machine,  
19 leading to the organization of the control problem between the two fundamental categories:  
20 flight governance and flight management.

21  
22 {Emphasis added}

23  
24 It sounds like it is.

25  
26 Therefore, the Duggan ‘232 patent is invalid for failing to meet the requirements of 35 U.S.C 102.

27  
28 Note that the Duggan “Variable Autonomy Control System” was developed under Air Force  
29 Research Lab funding. That would give the Government certain patent rights in the invention. This  
30 is not stated in the Duggan ‘232 patent.

31  
32 Geneva also filed an application to trademark “VCAS”. They made the same declaration as they did  
33 for “Variable Autonomy Control System” and included the same company website page. See  
34 Exhibit 7 at 190.

35

1 Dave Duggan of Geneva Aerospace and Luis A. Piñeiro of AFRL presented a paper at the 2002  
2 AUVSI Symposium. The paper from the Proceedings is reproduced as Exhibit 8 at 195. From  
3 Exhibit 8 at 196, last paragraph under the heading **VACS Overview**:

4  
5 Funding for the variable autonomy control concept was provided under the Small Business  
6 Innovative Research (SBIR) program Phase I, Phase II, and Phase III funding vehicles through  
7 the Air Force Research Laboratory (AFRL) Human Effectiveness and Air Vehicles Integration  
8 Directorates (Reference 1).

9  
10 Reference 1 says:

11 1. Duggan, David S., "Demonstration of an Integrated Variable Autonomy UAV Flight  
12 Control System", Phase II SBIR Final Report, AFRL-HE-WP-TR-2001-0035, January 2001

13

14 Applicant has not been able to obtain this reference from DTIC.

15

16 However, Duggan/Geneva Aerospace's Provisional Application (Application Number 60/480,192)  
17 contains Geneva Aerospace's **Small Business Innovation Research (SBIR) Program Projects**  
18 **Summary**, Topic Number AF98-179 (Exhibit 9 at 211), which shows that Geneva Aerospace had  
19 the invention described in '232 in its possession as early as the date the SBIR Project Summary for  
20 AF98-179 was submitted. According to the Air Force SBIR Web site at  
21 <http://www.afsbirsttr.com/TechMall/Default.aspx?kwa=AF98-179> the SBIR Phase I Contract  
22 started 5/14/1998, ended 2/14/1999, and the date of the DTIC report is 3/20/2001. See Exhibit 10 at  
23 235.

24

25 This suggests that Geneva Aerospace was being truthful in their Trademark Applications, that the  
26 products named Variable Autonomy Control Systems and VACS were first used commercially as  
27 early as 09/01/1998.

28

29 The '232 patent claims priority from Provisional Application 60/480,192 filed June 20, 2003 and  
30 incorporates the Provisional Application in its entirety in the '232 patent. See '232 Column 1, lines  
31 6 - 9. However, Provisional Application 60/480,192 was not made available to the public on PAIR  
32 until November 22, 2010. See Margolin Declaration § 14. As a result, the public was not able to  
33 read the entire '232 patent until November 22, 2010.

1  
2 The Duggan Provisional Application contains an Information Disclosure Statement (PTO-1449),  
3 filed July 29, 2004 listing a number of patent references. See Exhibit 11 at 237. With the exception  
4 of U.S. Patent 5,904,724 none of the other patent references are listed on the '232 patent. And, with  
5 the exception of 5,904,724 none of the references cited by Duggan in his Provisional Application  
6 are marked as having been considered by the Duggan Examiner.

7  
8 The irregularities surrounding the '232 patent would call for an investigation by the USPTO's  
9 Inspector General, but the USPTO does not seem to have an Inspector General.

10  
11 **Section 3.**

12  
13 For the foregoing reasons, Applicant submits that all objections and rejections have been overcome.  
14 Applicant requests that the rejection of pending claims 1-14 be withdrawn and that the application  
15 be allowed as filed.

16  
17 Respectfully submitted,

18  
19 /Jed Margolin/                      Date: November 29, 2010

20 Jed Margolin

21  
22  
23 Jed Margolin  
24 1981 Empire Rd.  
25 Reno, NV 89521-7430  
26 (775) 847-7845

27

28

29



1 **IN THE UNITED STATES PATENT AND TRADEMARK OFFICE**

2  
3 In re Application of Jed Margolin

4 Serial No.: 11/736,356

Examiner: Ronnie M. Mancho

5 Filed: 04/17/2007

Art Unit: 3664

6 For: SYSTEM AND METHOD FOR SAFELY FLYING UNMANNED AERIAL VEHICLES  
7 IN CIVILIAN AIRSPACE

8  
9 DECLARATION OF JED MARGOLIN

10  
11 I, Jed Margolin, declare as follows:

12  
13 1. I am the Applicant in the above patent application.

14  
15 2. I am the named inventor (Jed Margolin) on U.S. Patent 5,904,724 **Method and apparatus for**  
16 **remotely piloting an aircraft** issued May 18, 1999.

17  
18 3. Exhibit 1 is a true and accurate reproduction of the article **NASA Plans UAS Push** by Graham  
19 Warwick that appeared in Aviation Week & Space Technology, August 16, 2010, page 13.

20  
21 4. Exhibit 2 is a true and accurate reproduction of documents from the image filewrapper for the  
22 Duggan Application 10/871,612 that I downloaded from the USPTO's PAIR Web site on or about  
23 November 1, 2010.

24  
25 5. Exhibit 3 is a true and accurate reproduction of the License Agreement between Geneva  
26 Aerospace, Optima Technology, Inc., and myself. I have redacted financial information as per  
27 Federal Rules of Civil Procedure Rule 5.2. I have also redacted other sensitive information. (Note  
28 that Optima Technology, Inc. subsequently changed their name to Optima Technology Group.)

29  
30 6. Exhibit 4 is a true and accurate reproduction of public documents that I downloaded from the  
31 Palm Beach County, Florida Web site at [http://oris.co.palm-beach.fl.us/or\\_web1/or\\_sch\\_1.asp](http://oris.co.palm-beach.fl.us/or_web1/or_sch_1.asp)  
32 between approximately August 30, 2010 and September 13, 2010.

1 7. Exhibit 5 is a true and accurate reproduction of the Web page that I downloaded from  
2 <http://ntsa.metapress.com/link.asp?id=4mrrc0aupmjpf8e6> on or about November 16, 2010, showing  
3 the availability of the paper **Lessons Learned and Future Challenges** by Dr. Dutch Guckenberger  
4 and Matt Archer presented at the 2000 Interservice/Industry Training, Simulation & Education  
5 Conference (I/ITSEC), and part of Volume: 2000 (Conference Theme: Partnerships for Learning in  
6 the New Millennium, followed by the title page and the seventh page from the paper that I  
7 purchased from Meta Press on or about November 16, 2010.

8  
9 8. Exhibit 6 is a true and accurate reproduction of documents filed by Geneva Aerospace in  
10 Trademark Application, Serial Number 78355947 for “Variable Autonomy Control System” that I  
11 downloaded from the USPTO Trademark Document Retrieval (TDR) Web site at  
12 <http://tportal.uspto.gov/external/portal/tow> on or about November 17, 2010.

13  
14 9. Exhibit 7 is a true and accurate reproduction of documents filed by Geneva Aerospace in  
15 Trademark Application, Serial Number 78355939 for “VACS” that I downloaded from the USPTO  
16 Trademark Document Retrieval (TDR) Web site at <http://tportal.uspto.gov/external/portal/tow> on  
17 or about November 17, 2010.

18  
19 10. Exhibit 8 is a true and accurate reproduction of the paper **Development and Testing of a**  
20 **Variable Autonomy Control System (VACS) for UAVs** by Dave Duggan of Geneva Aerospace  
21 and Luis A. Piñero of AFRL contained in the Proceedings AUVSI Symposium, 2002, that was  
22 given to me by AUVSI (Association of Unmanned Vehicles International) on November 18, 2010.

23  
24 11. Exhibit 9 is a true and accurate reproduction of the document contained in Geneva Aerospace  
25 Provisional Application 60/480,192 **Small Business Innovation Research (SBIR) Program**  
26 **Projects Summary, Topic Number AF98-179**, that I downloaded from PAIR on November 22,  
27 2010.

28  
29 12. Exhibit 10 is a true and accurate reproduction of the Web page containing Geneva Phase I  
30 Contract information for AF98-179 that I downloaded from the Air Force SBIR Web site at  
31 <http://www.afsbirsttr.com/TechMall/Default.aspx?kwa=AF98-179> on November 26, 2010.

32

1 **13.** Exhibit 11 is a true and accurate reproduction of the Information Disclosure Statement in the  
2 Duggan Provisional Application 60/480,192 that I downloaded from PAIR on November 22, 2010.

3  
4 **14.** November 22, 2010 was the first day that Provisional Application 60/480,192 became available  
5 to the public on PAIR. Provisional Application 60/480,192 became available to the public on PAIR  
6 only as a result of my telephone conversations with Mr. Don Levin (Director of SEARCH AND  
7 INFORMATION RESOURCES ADMINISTRATION) and Mr. Richard Fernandez (of that same  
8 office) the previous week.

9  
10  
11 I hereby declare under the penalty of perjury that the foregoing is true and correct to the best of my  
12 knowledge and belief.

13

14 Dated: November 29, 2010

15

Jed Margolin  
Jed Margolin

1

2

**Exhibit 1** – AWST Article **NASA Plans UAS Push**

## LEADING EDGE



BY GRAHAM WARWICK

Senior Editor-Technology  
Graham Warwick blogs at:  
[AviationWeek.com/leadingedge](http://AviationWeek.com/leadingedge)  
[warwick@aviationweek.com](mailto:warwick@aviationweek.com)

## COMMENTARY

# NASA Plans UAS Push

Agency uses them for scientific research, but has lacked a focus on UAVs—until now

NASA's Ikhana, a Predator B, will be used in several demonstrations planned under the new program.

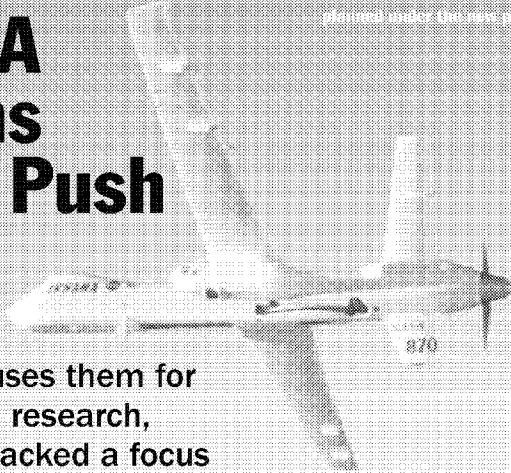

NASA/JIM ROSS

**N**ASA is seeking industry feedback on its plans for a new five-year, \$150-million program to help integrate unmanned aircraft into civil airspace. The feedback is likely to be mixed, as the agency's last major unmanned aircraft research program was canceled before it got off the ground, despite industry backing.

Briefed to industry experts in early August, the Unmanned Air Systems (UAS) Integration in the National Airspace System (NAS) project is planned to begin in Fiscal 2011. It would be NASA's first major unmanned aircraft effort since the High-Altitude Long-Endurance Remotely Operated Aircraft (HALE ROA) project was killed in 2005.

The new program would focus on separation assurance and collision avoidance, pilot-aircraft interface, certification requirements and communications, involving a series of increasingly complex flight demonstrations. The main goal is to generate data to help the FAA and standards organizations develop guidelines and regulations for the design and operation of UASs in the NAS. The research is expected to have an impact in the 2015-25 timeframe.

NASA has tried to avoid duplication with, and identify gaps in, UAS civil-airspace integration efforts already underway, says Jeff Bauer, project planning lead. "Scope has

been the biggest thing we have struggled with—what are the right things to do," he says. The result is a hodge-podge, lacking the singular vision of the HALE ROA project, which was the intended centerpiece of a government-industry plan to enable routine operations by long-endurance UAVs in airspace above 18,000 ft.

Some industry experts believe the new program is too near-term and that NASA should focus on longer-term challenges such as autonomy. Others think the program is "late to need" and that some of the data to be generated are required urgently to support efforts in progress to certify small unmanned aircraft and secure

dedicated frequency spectrum for UAS command-and-control links.

NASA did not have free rein in scoping out the program as its direction from Congress and the Obama administration was to coordinate with the FAA and Defense and Homeland Security departments to address operational and safety issues with UAS integration into the NAS while avoiding duplication.

As a result, the separation assurance and collision-avoidance project will focus on real-time trajectory and contingency monitoring to provide an additional layer of safety for air traffic controllers and UAS operators. NASA will also develop mission planning tools to automate contingency procedures after communications or systems failures while minimizing the impact of UAS operations on air transport system capacity and delays.

The pilot-aircraft interface project will develop guidelines for designing or modifying ground control stations to be compliant with NAS requirements. This could involve adding audible, tactile and visual cues, and will culminate in a proof-of-concept demonstration using a Predator B ground station modified for NAS compliance.

Initially, the communications project will support work underway to secure dedicated "safety of flight" spectrum for UAS command-and-control links at the 2012 World Radiocommunication Conference. Subsequently, the project will develop and test prototypes of a data link radio that meets safety, security and scalability requirements.

Finally, NASA plans to provide the FAA with a methodology for developing airworthiness requirements for the certification of UAS. While some argue that manned aircraft certification rules should be the starting point, the agency believes the balance between probability of failure and severity of consequences used to define airworthiness requirements for passenger-carrying aircraft needs to be reassessed for unmanned aircraft. NASA also plans to assess UAS-specific hazards and risks and develop guidance for type design, focusing on the automation aspects. ☐

1

2

**Exhibit 2** – Duggan Filewrapper Documents

-154-

to support transition between the first and second modes of control.

31. A multi-modal variable autonomy control system, the system comprising:

a plurality of control mode components each corresponding to a different mode of control and being configured to respond to command inputs by generating directionally descriptive control commands; and  
a unified autopilot component for processing said directionally descriptive control commands.

an vehicle control component for receiving processed commands from the unified autopilot system and actuating control devices accordingly.

32. The system of claim 31, wherein said plurality of control mode components are associated with more than three different modes of control.

33. The system of claim 31, wherein said plurality of control mode components are associated with both autonomous and user-input-based modes of control.

34. The system of claim 31, wherein said plurality of control modes are further configured to respond to

IFW



IN THE UNITED STATES PATENT AND TRADEMARK OFFICE

First Named Inventor : David S. Duggan et al.

Appln. No. : 10/871,612

Filed : June 18, 2004

For : VEHICLE CONTROL SYSTEM INCLUDING RELATED METHODS AND COMPONENTS

Docket No.: G46.12-0001

Group Art Unit: 3661

Examiner:

SUPPLEMENTAL INFORMATION DISCLOSURE STATEMENT

Commissioner for Patents  
P.O. Box 1450  
Alexandria, VA 22313-1450

I HEREBY CERTIFY THAT THIS PAPER IS BEING SENT BY U.S. MAIL, FIRST CLASS, TO THE COMMISSIONER FOR PATENTS, P.O. BOX 1450, ALEXANDRIA, VA 22313-1450, THIS

19<sup>th</sup> DAY OF November, 2005

*[Signature]*

PATENT ATTORNEY

Sir:

The patents or publications listed on the enclosed PTO Form-1449 are submitted pursuant to 37 C.F.R. § 1.97. Copies of the foreign references or "other art" references are included.

LIST REFERENCES NOT SUBMITTED

TIME OF FILING

The information disclosure statement is being filed:

- 1. X 1. Within three months of the filing date of a national application other than a Continued Prosecution Application (CPA);
- 2. Within three months of the date of entry of the National Stage international application;
- 3. Before the mailing date of a first Office Action on the merits; or
- 4. Before the mailing of a first Office Action after the filing of a Request for Continued Examination (RCE).



2. \_\_\_ after the time period specified in paragraph 1 above, but before the mailing date of a final action under 37 C.F.R. § 1.113 or notice of allowance under 37 C.F.R. § 1.311. Therefore, in accordance with 37 C.F.R. § 1.97(c), submitted herewith is:

(check either A or B below)

- A. \_\_\_ a statement as specified in 37 C.F.R. § 1.97(e).
- B. \_\_\_ the fee set forth in 37 C.F.R. § 1.17(p) for submission of an information disclosure statement under 37 C.F.R. § 1.97(c).

3. \_\_\_ after the mailing date of either a final action under 37 C.F.R. § 1.113 or a notice of allowance under 37 C.F.R. § 1.311, whichever occurs first, but before payment of the issue fee. Therefore, Applicant petitions for consideration and submits herewith:

- A. a statement as specified in 37 C.F.R. § 1.97(e);
- B. the petition fee set forth in 37 C.F.R. § 1.17(p).

**STATEMENT**

(only used if No. 2(A) or No. 3 above is checked)

The person(s) signing below certify

(check appropriate paragraph)

\_\_\_ that each item of information contained in this Information Disclosure Statement was first cited in any communication from a foreign patent office in a counterpart foreign application not more than three months prior to the filing of this statement. 37 C.F.R. § 1.97(e)(1).

OR

\_\_\_ that no item of information contained in this Information Disclosure Statement was cited in a communication from a foreign patent office in a counterpart foreign application or, to the knowledge of the person signing the certification after making reasonable inquiry, was known to any individual designated in 37 C.F.R. § 1.56(c) more than

-3-

three months prior to the filing of this statement. 37  
C.F.R. § 1.97(e)(2).

**METHOD OF PAYMENT**

No fee is required.  
 Attached is a check in the amount of \$\_\_\_\_\_.

The Director is authorized to charge any fee deficiency  
required by this paper or credit any overpayment to Deposit  
Account No. 23-1123.

Respectfully submitted,

WESTMAN, CHAMPLIN & KELLY, P.A.

By:

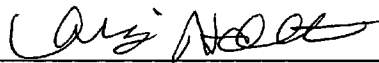

Christopher L. Holt, Reg. No. 45,844  
Suite 1400 - International Centre  
900 Second Avenue South  
Minneapolis, Minnesota 55402-3319  
Phone: (612) 334-3222  
Fax: (612) 334-3312

CLH:rkp

FORM PTO-1449	Atty. Docket No.: G46.12-0001	Appl. No.: 10/871,612
LIST OF PATENTS AND PUBLICATIONS FOR APPLICANT'S INFORMATION DISCLOSURE STATEMENT	First Named Inventor:	
	David S. Duggan et al.	
	Filing Date	Group Art:
	June 18, 2004	3661



U.S. PATENT DOCUMENTS

Examiner Initial	Document No.	Date	Name	Class	Sub Class	Filing Date If Appropriate
AA	U.S. Patent Pub. No. US 2005-0256938 A1	11/2005	Margolin	709	218	
AB	5,666,531	09/1997	Martin	395	620	
AC	5,422,998	06/1995	Margolin	395	166	
AD	5,553,229	09/1996	Margolin	395	166	
AE	5,933,156	08/1999	Margolin	345	509	
AF	5,566,073	10/1996	Margolin	364	449	
AG	5,904,724	05/1999	Margolin	701	120	
AH	5,974,423	10/1999	Margolin	707	104	
AI	6,023,278	02/2000	Margolin	345	419	
AJ	6,377,436	04/2002	Margolin	361	230	
AK	6,177,943	01/2001	Margolin	345	419	
AL	5,978,488	11/1999	Margolin	381	61	

FOREIGN PATENT DOCUMENTS

	Document No.	Date	Country	Class	Sub Class	Translation Yes No
AM						

OTHER ART (Including Author, Title, Date, Pertinent Pages, Etc.)

AN	
AO	
AP	

EXAMINER:

DATE CONSIDERED:

EXAMINER: Initial if citation considered, whether or not citation is in conformance with MPEP 609; draw line through citation if not in conformance and not considered. Include copy of this form with next communication to applicant.

-5-

Sheet 2 of 2

FORM PTO-1449	Atty. Docket No.: G46.12-0001	Appl. No.: 10/871,612
LIST OF PATENTS AND PUBLICATIONS FOR APPLICANT'S INFORMATION DISCLOSURE STATEMENT	First Named Inventor:	
	David S. Duggan et al.	
	Filing Date	Group Art:
	June 18, 2004	3661

U.S. PATENT DOCUMENTS

Examiner Initial	Document No.	Date	Name	Class	Sub Class	Filing Date If Appropriate
AQ	6,862,501	03/2005	He	701	3	
AR	6,062,513	05/2000	Lambregts	244	175	
AS	4,155,525	05/1979	Peter-Contesse	244	182	
AT	6,304,819	10/2001	Agnew et al.	701	207	
AU	6,064,939	05/2000	Nishida et al.	701	120	
AV	6,498,984	12/2002	Agnew et al.	701	207	
AW						

FOREIGN PATENT DOCUMENTS

	Document No.	Date	Country	Class	Sub Class	Translation Yes No
AX						

OTHER ART (Including Author, Title, Date, Pertinent Pages, Etc.)

AY	RIS Press Releases - <a href="http://www.landform.com/pages/PressReleases.htm">http://www.landform.com/pages/PressReleases.htm</a> . 4 pgs.
AZ	Beringer, D.; "Applying Performance-Controlled Systems, Fuzzy Logic, and Fly-By-Wire Controls to General Aviation Office of Aerospace Medicine, May 2002, pgs. 1-8.
BA	R. Parrish et al.; "Spatial Awareness Comparisons Between Large-Screen, Integrated Pictorial Displays and Conventional EFIS Displays During Simulated Landing Approaches," NASA Technical Paper 3467, CECOM Technical Report 94-E-1, October 1994, 1-22.
BB	Office of the Secretary of Defense, Airspace Integration Plan for Unmanned Aviation November 2004.
BC	Abernathy, M.; "Virtual Cockpit Window" for a Windowless Aerospacecraft. <a href="http://www.nasatech.com/Briefs/Jan03/MSC23096.html">http://www.nasatech.com/Briefs/Jan03/MSC23096.html</a> , Jan. 2003. 2 pgs.

EXAMINER:	DATE CONSIDERED:
-----------	------------------

EXAMINER: Initial if citation considered, whether or not citation is in conformance with MPEP 609; draw line through citation if not in conformance and not considered. Include copy of this form with next communication to applicant.

<b>Interview Summary</b>	<b>Application No.</b> 10/871,612	<b>Applicant(s)</b> DUGGAN ET AL.	
	<b>Examiner</b> Gertrude Arthur-Jeanglaude	<b>Art Unit</b> 3661	

All participants (applicant, applicant's representative, PTO personnel):

(1) Gertrude Arthur-Jeanglaude. (3) \_\_\_\_\_

(2) Christopher Holt ( Reg # 45,844). (4) \_\_\_\_\_

Date of Interview: 26 November 2007.

Type: a)  Telephonic b)  Video Conference  
 c)  Personal [copy given to: 1)  applicant 2)  applicant's representative]

Exhibit shown or demonstration conducted: d)  Yes e)  No.  
 If Yes, brief description: \_\_\_\_\_

Claim(s) discussed: 31.

Identification of prior art discussed: none.

Agreement with respect to the claims f)  was reached. g)  was not reached. h)  N/A.

Substance of Interview including description of the general nature of what was agreed to if an agreement was reached, or any other comments: To amend claim 31 to correct typo errors.

(A fuller description, if necessary, and a copy of the amendments which the examiner agreed would render the claims allowable, if available, must be attached. Also, where no copy of the amendments that would render the claims allowable is available, a summary thereof must be attached.)

THE FORMAL WRITTEN REPLY TO THE LAST OFFICE ACTION MUST INCLUDE THE SUBSTANCE OF THE INTERVIEW. (See MPEP Section 713.04). If a reply to the last Office action has already been filed, APPLICANT IS GIVEN A NON-EXTENDABLE PERIOD OF THE LONGER OF ONE MONTH OR THIRTY DAYS FROM THIS INTERVIEW DATE, OR THE MAILING DATE OF THIS INTERVIEW SUMMARY FORM, WHICHEVER IS LATER, TO FILE A STATEMENT OF THE SUBSTANCE OF THE INTERVIEW. See Summary of Record of Interview requirements on reverse side or on attached sheet.

Examiner Note: You must sign this form unless it is an Attachment to a signed Office action.

\_\_\_\_\_  
Examiner's signature, if required

1

2

**Exhibit 3** – Geneva License Agreement

1



Geneva Aerospace, Inc  
4240 International Parkway, Suite 100  
Carrollton, TX 75007  
469-568-2376  
Fax 469-568-2101

May 17<sup>th</sup>, 2006

SAMUELS, GREEN, STEEL & ADAMS, LLP  
Mr. Scott Albrecht, Esq.  
19800 MacArthur Blvd, Suite 1000  
IRVINE, CA, 92612

**SUBJECT: RPV NON-EXCLUSIVE LICENSE AGREEMENT**

Dear Mr. Albrecht,

I am enclosing two (2) originals of a "RPV NON-EXCLUSIVE LICENSE AGREEMENT". Please, have both copies signed and dated. Retain one executed original for your files and return one executed copy to Mr. Alan Barker at the above address.

Best regards,

Corinne Leroux  
Assistant

2

---

RPV NON-EXCLUSIVE LICENSE AGREEMENT

This Agreement is made this 01 day of May, 2006 ("Effective Date") by and between Optima Technology Inc. (hereinafter referred to as "Licensor"), a Delaware corporation, Mr. Jed Margolin (hereinafter referred to as "Inventor"), an individual, both having a place of business at 2222 Michelson Drive, Suite 1830, Irvine, California 92612 USA, and Geneva Aerospace®, Inc., a Texas corporation (hereinafter referred to as "Licensee"), having its principal place of business at 4240 International Parkway, Suite 100, Carrollton, TX 75007, individually referred to as "Party" and collectively as the "Parties."

WITNESSED THAT

**WHEREAS**, as is demonstrated by the document(s) attached hereto as Exhibit A, Licensor has obtained from Inventor the right to provide a license under certain patents as herein identified; and

**WHEREAS**, Inventor is the named inventor in one or more of said patents; and

**WHEREAS**, Licensee desires to obtain, and Licensor is willing to grant Licensee, a non-exclusive license as hereafter defined and under the terms and provisions herein specified.

**NOW, THEREFORE**, in consideration of the promises and mutual agreements herein contained Licensor, Inventor and Licensee agree as follows:

TERMS

1. DEFINITIONS

- 1.1 The term "consist" limits and covers only the elements expressly recited. By contrast, the utilization of the terms "include," "such as," and "for example" are not limited and therefore cover more elements than those recited.
- 1.2 "Affiliate" shall mean any corporation or the like at least fifty percent (50%) of whose voting share capital is owned or directly or indirectly controlled by or under common control with a Party as of the Effective Date of this Agreement or at any time during the term of this Agreement and any other entity over which a Party exercises effective managerial control.
- 1.3 "Days" shall mean calendar days.
- 1.4 "RPV" shall mean "remotely piloted vehicle." A "remotely piloted aircraft" is an RPV. "UAV" shall mean "unmanned aerial vehicle." RPV is an older term for UAV. "UCAV" shall mean "Unmanned Combat Aerial Vehicle." UCAV is also sometimes defined as an "Uninhabited Combat Aerial Vehicle." UCAV is a UAV



that is intended for use in combat. UCAS means "Unmanned Combat Air System."

- 1.5 "Synthetic Vision" is the current term for "Synthetic Environment" and is the three dimensional projected image data presented to the pilot or other observer.
- 1.6 "Patent Portfolio" shall mean the portfolio consisting of United States Patent Numbers 5,904,724 (Method and Apparatus for Remotely Piloting an Aircraft), 5,566,073 (Pilot Aid Using a Synthetic Environment), and those future United States patents that may be added in accordance with the covenants and warranties set forth in Section 8.1.
- 1.7 "Royalty Products" shall mean only the product identified as Licensee Part Number 606-0069-001 missionTEK Synthetic Image Module described as situational awareness aid for a UAV operator using missionTEK. This Part Number excludes the SDS Acuity IG software package hosted on a rack mount computer. This Part Number interfaces to mission TEK through an Ethernet connection and creates a synthetic image of a UAV that is driven by the current vehicle telemetry stream on the product order form attached hereto as Exhibit B. The other products and options identified in Exhibit B are specifically excluded from the definition of "Royalty Products." It is to be understood that Royalty Products shall include systems or components that are manufactured outside the United States, its territories, or possessions and which can reasonably be expected to be used or sold within the United States, its territories, or possessions and/or including and covering all countries on planet Earth and surrounding planets/systems, so long as those systems or components are also identified in Exhibit B as Licensee Part Number 606-0069-001 missionTEK Synthetic Image Module described as situational awareness aid for a UAV operator using missionTEK. This Part Number excludes the SDS Acuity IG software package hosted on a rack mount computer. This Part Number interfaces to mission TEK through an Ethernet connection and creates a synthetic image of a UAV that is driven by the current vehicle telemetry stream.
- 1.8 "Sale or Sold" shall mean selling, leasing, or otherwise transferring ownership, possession, or use to another party, of a Royalty Product (except as scrap), either directly or through a chain of distribution, and shall be deemed to have occurred upon invoicing of a Royalty Product to a third party, or if not invoiced, when ownership, possession, or use is transferred to a third party directly or indirectly.
- 1.9 "Claims" shall mean one or more patent claims identified within the body of a Patent (s).
- 1.10 "Claims in the Patent Portfolio" shall mean Claims identified within the body of a Patent(s) included in the Patent Portfolio (defined in Section 1.6 of this Agreement).

2. LICENSE GRANT

- 2.1 Subject to the terms and provisions of this Agreement, and to Licensee making the payments required under Section 4.1, Licensor and Inventor grants to Licensee a royalty bearing non-exclusive, personal, non-transferable, worldwide right and license under the Claims in the Patent Portfolio to test, make, have made, use, import, export, distribute, offer for sale, sell, lease, and/or otherwise dispose of products in, or for, the United States and its territories and possessions, subject to any applicable export laws and regulations of the United States.
- 2.2 Subject to the terms and provisions of this Agreement, and to Licensee making the payments required under Section 4.1, Licensor and Inventor grants to Licensee the right to extend to its direct and indirect distributors, suppliers, dealers, and customers its right, under the Claims in the Patent Portfolio, to test, make, have made, use, import, export, distribute, offer for sale, sell, lease, and/or otherwise dispose of products in, or for, the United States and its territories and possessions subject to any applicable exports laws and regulations of the United States.
- 2.3 Subject to execution of this agreement by the Parties, Licensor and Inventor release and forever discharge Licensee (and its direct and indirect distributors, suppliers, dealers and customers) from any and all claims, liens, demands, causes of action, obligations, losses, damages, and liabilities, known or unknown, suspected or unsuspected, liquidated or unliquidated, fixed or contingent, that they have had in the past or now have or may have in the future under any of the Claims in the Patent Portfolio based on or arising out of products Sold, prior to and including May 01, 2006 by Licensee in, or for, the United States and its territories and possessions.
- 2.4 Subject to the terms and provisions of this Agreement, and to Licensee making the payment required under Section 4.1 and during the term of the life of this Agreement, Licensor and Inventor further represent, covenant and agree that neither they nor any entity directly or indirectly controlled by either will bring suit or otherwise assert a claim for infringement against Licensee (or its direct and indirect distributors, suppliers, dealers or customers) before any court or administrative agency in any country of the world based on or arising out of products Sold by Licensee in, or for, the United States and its territories and possessions.
- 2.5 The release and covenant not to sue provided in Sections 2.3 and 2.4, as well as any other releases or covenants not to sue set out in this Agreement, shall bind any assignee or other person to whom the Assignor or Inventor may assign ownership or control of Claims in the Patent Portfolio.
- 2.6 Licensor and Inventor grants to Licensee the right to sublicense to an Affiliate of Licensee the rights granted to Licensee under this Agreement; provided that the

Affiliate is bound by the terms and provisions of this Agreement as if it were named in the place of Licensee, and provided that the Affiliate shall pay and account, directly or through Licensee, to the Licensor the royalties payable under this Agreement as a result of the activities of the Affiliate as if it were named in the place of Licensee. Any rights granted to an Affiliate shall terminate automatically and without notice on the date such Affiliate ceases to be an Affiliate; provided, however, that such termination shall not affect the rights granted to the Affiliate for acts occurring prior to the effective date of such termination. Upon written request from Licensor as to whether a particular entity or entities is an Affiliate, Licensee will answer such request in writing within thirty (30) Days from receipt of the request.

- 2.7 The rights, grants, covenants, and terms of Section 2.1, 2.2, 2.4, and 4.1 shall not apply to Royalty Products Sold by Licensee to a third party after Licensee was notified by Licensor that such third party has or had, directly or through others, asserted in any judicial proceeding or judicial document, at any time during the lifetime of this Agreement, that any of the Claims in the Patent Portfolio are invalid and/or not infringed.
- 2.8 The rights, grants, covenants, and terms of Sections 2.1, 2.2, 2.3, 2.4, and 4.1 shall not apply to Royalty Products Sold by Licensee to a third party for sale under a brand not owned or controlled by Licensee unless: (i) such third party has executed with Licensor a License Agreement; and/or (ii) Licensee pays the Royalty, under Sections 4.1 and 4.2, to Licensor for every Royalty Product Sold by such third party in, or for, the United States and its territories and possessions.
3. LIMITS ON SCOPE OF LICENSE GRANT
- 3.1 Any license grant or other authorization that may be provided by Licensor or Inventor to Licensee under this Agreement or to a third party does not provide, directly, by implication, or otherwise, any license grant, or authorization to Licensee to make, have made, use, import, export, distribute, offer for sale, sell, rent, or otherwise dispose of RPV systems for use by R/C hobbyists; and/or to make, have made, test, use, import, export, distribute, offer for sale, sell or lease, or otherwise dispose of equipment used to product or manufacture RPV systems for use by R/C hobbyists.
- 3.2 Any third party which acquires rights under this agreement is bound by the requirements of section 3.1.
4. ROYALTY AND PAYMENTS
- 4.1 In consideration for the licenses, covenants not to sue, and other rights granted by Licensor and Inventor to Licensee under this Agreement relative to Royalty Products Sold by Licensee in, or for, the United States and its territories and possessions and/or including and covering all countries on planet Earth and

surrounding planets/systems after May, 01, 2006, Licensee agrees to pay Licensor a continuing "Royalty" throughout the term of this Agreement equal to five percent (5%) for each such Royalty Product.

- 4.2 [DELETED BY PARTIES DURING NEGOTIATION]
- 4.3 Only one Royalty shall be paid on any Royalty Product with respect to the Claims in the Patent Portfolio regardless as to whether the Royalty Product is encompassed by one or more of the Claims in the Patent Portfolio. Licensee shall not be required to make payments under Section 4.1 as to Royalty Products Sold by Licensee where the Royalty due has been paid to Licensor by a third party. Licensee shall not be required to make payments under Section 4.1 as to Royalty Products Sold by Licensee and subsequently found defective and returned to Licensee for full credit, and not thereafter Sold by Licensee in, or for, the United States and its territories and possession and/or including and covering all countries on planet Earth and surrounding planets/systems.
- 4.4 The Parties understand that there should be no taxes imposed by any foreign country on the income of Licensor paid under this Agreement. However, to the extent, if any, that such taxes are imposed for any reason: (i) such taxes shall be borne by Licensor; (ii) Licensee will deduct such tax from the amounts payable to Licensor and pay such tax to the appropriate authority in the name of and on behalf of Licensor; (iii) Licensee shall send to Licensor certificates of tax payment in due course after each payment of the tax; and (iv) Licensee agrees to submit and to file any document to the competent foreign revenue office, that is required to have such certificate issued.
- 4.5 If any other entity is granted a license under any of the Claims in the Patent Portfolio with respect to Royalty Products under any more favorable economic terms than those granted to Licensee under this Agreement, then Licensor shall disclose, in writing, to Licensee the terms and provisions of each such license within thirty (30) Days of its execution, and Licensee shall have the right, within ninety (90) Days of receipt of such disclosure, to substitute all of the terms and provisions in this Agreement with all of the terms and provisions of the subsequent license, retroactive to the date that the subsequent license agreement was executed.
5. REPORTS
- 5.1 Licensee shall keep sales records of all Royalty Products Sold by Licensee during the term of this Agreement in, or for, the United States and its territories and possessions and/or including and covering all countries on planet Earth and surrounding planets/systems. These sales records shall be of sufficient detail to permit verification in accordance with the accuracy and completeness of the information and the royalties required to be reported and paid under this

Agreement. Licensee shall keep such records for at least five (5) years after each due date for royalty payments under this Agreement.

- 5.2 Licensee shall send Licensor a written "Royalty Report", accompanied in the manner provided for in Section 5.7 by the proper amount then payable to Licensor as shown in such Royalty Report,:
- (a) on or before the thirtieth (30<sup>th</sup>) day after termination of this Agreement; and
  - (b) on or before the last day of the months of January, April, July and October of each year during the term of this Agreement. However, if less than one thousand Royalty Products are Sold by Licensee in, or for, the United States and its territories and possessions and/or including and covering all countries on planet Earth and surrounding planets/systems during a calendar year, then the four (4) quarterly reports and payments for the next calendar year immediately following may be combined in a single annual Royalty Report and payment made on or before the last day of January immediately following such next calendar year.
- 5.3 The Royalty Report shall be certified in its correctness by Licensee's representative responsible for paying such on Licensee's behalf in the normal course of Licensee's business, and providing information such as:
- (a) the total number of Royalty Products, by product category, Sold by Licensee in; or for, the United States and its territories and possessions and/or including and covering all countries on planet Earth and surrounding planets/systems during the preceding calendar quarter;
  - (b) the royalty amount due for such calendar quarter; and
  - (c) the total number of Royalty Products, by product category, Sold by Licensee in, or for, the United States and its territories and possessions and/or including and covering all countries on planet Earth and surrounding planets/systems during such calendar quarter for which the Royalty due from Licensee was paid for by a third party and an identification of each such third party.
- 5.4 In the event that any Royalty Report and payment are not made by or on behalf of Licensee by the date provided under this Agreement, interest shall be payable on the past due amounts at the rate of the prime lending rate as published in the Wall Street Journal from time to time plus 2%, compounded semi-annually. This interest shall be calculated from the date payment was due to the payment date. This interest payment shall be in addition to any other remedy provided to Licensor by law or by this Agreement.

- 5.5 Licensor shall maintain Royalty Reports of Licensee as "Confidential Information" in accordance with Article 9 of this Agreement. Confidential Information shall also include any other information provided by Licensee to Licensor and which is designated in good faith as confidential by Licensee.
- 5.6 Licensor shall have the right, during reasonable business hours and at the reasonable convenience of Licensee, to have the correctness of any Royalty Report of Licensee audited, at licensor's expense, by a firm of independent public accountants, selected by Licensor, and reasonably acceptable to Licensee. The independent public accountants shall examine Licensee's records only on matters pertinent to this Agreement. Nor more than one such audit shall be performed per year, unless Licensee has underreported as provided in the following sentence. In the event it is determined by the independent public accountants, at any time, that Licensee has underreported in an amount in excess of five percent (5%) of the royalties properly due with respect to one or more Royalty Reports, then Licensee, in addition to any other remedy provided Licensor by law or by this Agreement, agrees and is bound to:
- (a) Reimburse Licensor's full cost and expense associated with the audit; and
  - (b) Pay Licensor an amount equal to one hundred and twenty-five (125%) of the amount that Licensee has failed to report or pay, along with interest at the rate of the prime lending rate as published in the Wall Street Journal from time to time plus two percent (2%), compounded semi-annually, calculated from the date each royalty accrued to the date of payment under this Section.

Any payments due under this Section shall be due and payable within thirty (30) Days following notice from Licensor of such failure, breach or default.

- 5.7 All royalty payments under this Agreement shall be paid in United States currency, without deductions of taxes of any kind other than as provided for in Section 4.4, payable to Licensor c/o SAMUELS, GREEN, STEEL & ADAMS, LLP, Scott Albrecht, Esq.; at 19800 Macarthur Blvd., Suite 1000, Irvine, California 92612-2433, U.S.A. by wire transfer to:

SAMUELS, GREEN, STEEL & ADAMS, LLP  
Scott Albrecht, Esq.; P.C. Client Trust

*[Financial Information Redacted]*

or to any other U.S.A. accounts, as instructed jointly and in writing by Licensor and Scott Albrecht, Esq.

- 5.8 In the event applicable exchange control regulations shall prevent remittance of United States currency payment hereunder by Licensee, Licensee agrees, at Licensor's option and in accordance with the requirement to make payments without deductions of taxes of any kind other than as provided for in Section 4.4, to deposit an equivalent amount in a currency as designated by Licensor, in a bank designated by Licensor for the account of Licensor, such equivalent amounts to be calculated using currency tables published in the Wall Street Journal.
6. TERM AND TERMINATION
- 6.1 This Agreement shall continue in full force and effect, unless sooner terminated by specific provisions in this Agreement, until the expiration date of the last remaining of the Claims in the Patent Portfolio, or until a final decree of invalidity from which no appeal or other judicial recourse can be, or is, taken of the last remaining of the Claims in the Patent Portfolio.
- 6.2 Licensee may terminate this Agreement at any time by sixty (60) Days written notice to Licensor.
- 6.3 Licensor may terminate this Agreement forthwith upon written notice to Licensee if:
- (a) Licensee remains in default in making any payment or supplying a Royalty report or fails to comply with any other provision for a period of thirty (30) Days, in each case after written notice of such default or failure is given by Licensor to Licensee, unless a genuine and good faith dispute exists as to the amount due and any amounts not in dispute are timely paid;
  - (b) Licensee shall make an assignment for the benefit of creditors, or any order for the compulsory liquidation of Licensee shall be made by any court;
  - (c) Licensee shall be finally determined by a court of competent jurisdiction to have (i) willfully or deliberately violated any material provision of this Agreement; (ii) concealed from Licensor any failure to comply with this Agreement including, but not limited to, the deliberate or willful understatement of royalties payable or the express refusal to timely pay royalties; and/or (iii) acted in bad faith in breaching any material provision of this Agreement. In such an event, the termination shall be effective as of the date of notice given by Licensor; and
  - (d) Licensee and/or any of its Affiliates, during the term of the Agreement, directly or through others, assert in any judicial proceeding or judicial document that any of the Claims in the Patent Portfolio are invalid.

6.4 Any termination of this Agreement shall not relieve Licensee of its liability for any payments accrued or owing prior to the effective date of such termination, or for any payments on Royalty Products manufactured by Licensee, in whole or in part, and located in the United States and its territories and possessions and/or including and covering all countries on planet Earth and surrounding planets/systems, prior to the effective date of such termination and Sold after the termination date.

## 7. ASSIGNMENTS

7.1 This Agreement may be assigned by Licensor provided that the assignment does not operate to terminate, impair or in any way change any obligations or rights that Licensor currently has under this Agreement, or any of the obligations or rights that Licensee would have had, if the assignment has not occurred. In the event the assignment is to a competitor of Licensee, Licensor and Inventor will continue to receive Royalty Reports made by Licensee on a confidential basis and will not reveal the contents of the Royalty Reports to the assignee.

7.2 This Agreement shall inure to the benefit of, and be binding upon, the successors and assigns of the Parties, but no purported assignment or transfer by Licensee of this Agreement or any part thereof shall have any force or validity whatsoever unless and until approved in writing by Licensor, except an assignment to a direct or indirect wholly-owned subsidiary of Licensee, or to a buyer of all or substantially all of an entire business unit or product line of Licensee to which this license pertains. However, any purported conveyance or any attempt by Licensee to confer or extend the benefits and privileges of this Agreement upon or to any entity shall be void and ineffective if that entity: (i) shall have, directly or indirectly, rejected or declined to accept a license from Licensor upon like, similar or more favorable terms as embodiment herein; and/or (ii) directly or through others, asserted in any judicial proceeding or document that any of the Claims in the Patent Portfolio are invalid.

## 8. COVENANTS, REPRESENTATIONS AND WARRANTIES

8.1 Licensor and Inventor warrant and covenant that: (i) if during the term of this Agreement, they own, control or acquire additional Claim(s), this Agreement will be supplemented to include such additional Claim(s) without the payment by Licensee of any royalties other than those required to be paid under this Agreement; (ii) they have the entire right, title and interest in and to the Claims in the Patent Portfolio; (iii) they have the right and authority to enter into this Agreement; (iv) they do not own or control any foreign issued patents or foreign pending patent applications; and (v) there are no liens, conveyances, mortgages, assignments, encumbrances or other agreements to which Licensor or Inventor are a party, or by which they are bound, that would prevent or impair the full exercise



of all substantive rights granted to Licensee by Licensor pursuant to the terms and provisions of this Agreement.

- 8.2 Licensor and inventor make no representation or warranty that Royalty Products will not infringe, directly, contributorily or by inducement under the laws of the United States or any foreign country, any patent or other intellectual property right of a third party.
- 8.3 Any dispute arising under or relating to this Agreement or in any dispute arising with respect or related to the subject matter of the Claims in the Patent Portfolio, which cannot be resolved by negotiation in good faith between the parties hereto, shall be resolved by an action brought in, and the Parties and their Affiliates who have agreed to be bound by this Agreement consent to the jurisdiction and venue of a court in the State of Delaware, U.S.A. Without regard to those laws relating to conflict of laws and the parties to this agreement hereby submit to the jurisdiction of the courts in the State of Delaware, U.S.A. in connection with any disputes arising out of this Agreement.
- 8.4 Licensee hereby submits for itself and its property in any legal action or proceeding relating to this Agreement, or for recognition and any enforcement of any judgment in respect thereof, to the non-exclusive general jurisdiction and forum of the courts of the State of Delaware in the United States of America, the courts of the United States of America for the District of Delaware, and appellate courts from any thereof. Licensee agrees not to raise, and waives, any objections or defenses based upon venue or forum non conveniens, except that Licensor may seek temporary injunctive relief in any venue of its choosing.
- 8.5 Licensee hereby designates the following agent in the United States for any service of any summons, complaint or other process in connection with any litigation arising out of this Agreement and Licensee agrees and certifies that such agent shall have full authority to accept the same on behalf of Licensee:

Name: W. Alan Barker, Geneva Legal Counsel  
Address: 4240 International Parkway  
Suite 100  
Carrollton, Texas 75007  
Tel.: (469) 568-2376 x112  
Fax: (469) 568-2100  
Email: abarker@genevaerospace.com

- 8.6 Licensee represents and warrants that Licensee assumes responsibility for obtaining all necessary official government approval, validation, and/or consent from the appropriate governmental authorities for the performance of this Agreement and for remittance of payment pursuant hereto and for registering or recording this Agreement as required; provided, however, that Licensee shall use its best efforts to provide that Licensor shall have the right to participate or be

- represented in any proceeding, hearing, negotiation or the like with governmental authorities relating to such approval, validation and/or consent.
- 8.7 Licensee and its Affiliates shall, upon request, grant to Licensor, Inventor, and/or their Affiliates a non-exclusive license to and release from any and all claims of infringement of any patents that are necessarily infringed when implementing the Intellectual Property or claiming technologies for which there is no realistic alternative in implementing the Intellectual Property and with respect to which Licensee has or may in the future obtain rights or controls, directly or indirectly, to grant such a license and release. Any such licenses and release shall be granted upon fair, reasonable, and non-discriminatory terms and provisions.
- 8.8 Every Party represents and warrants that in executing this Agreement, other than the promises, warranties and representations expressly made in this Agreement, it does not rely on any promises, inducements, or representations made by any Party or third party with respect to this Agreement or any other business dealings with any Party or third party, now or in the future.
- 8.9 Every Party represents and warrants that it is not presently the subject of a voluntary or involuntary petition in bankruptcy or the equivalent thereof, is not presently contemplating filing any such voluntary petition, and does not presently have reason to believe that such an involuntary petition will be filed against it.
- 8.10 Other than the express warranties of this Article, there are no other warranties, express or implied.
9. CONFIDENTIAL INFORMATION
- 9.1 For a period of five (5) years as measured from the first date of disclosure of Confidential Information pursuant to this Agreement, Licensor and Inventor agree to use reasonable care and discretion, at least commensurate with that degree of reasonable care they use to protect similar information of their own, to avoid disclosure, publication or dissemination of Confidential Information, outside of those employees, attorneys or consultants of Licensor, and independent public accountants selected by Licensor pursuant to Section 5.6, who have a need to know Confidential Information, and are bound by the terms of this Article to keep Confidential Information in confidence.
- 9.2 Disclosure by Licensor or Inventor of Confidential Information under Section 9.1 of this Agreement shall be permitted in the following circumstances; provided, that Licensor and Inventor shall have first given reasonable notice to Licensee that such disclosure is to be made:
- (a) in response to an order of a court, government or governmental body;
  - (b) otherwise as required by law; or

- (c) to the independent public accountants selected in accordance with Section 5.6 who agree in writing to maintain Confidential Information in confidence.

9.3 Notwithstanding any other provisions of this Agreement, the obligations specified in Section 9.1 of this Agreement will not apply to any Confidential Information that:

- (a) is or become publicly available without breach of this Agreement;
- (b) is released for disclosure by written consent of Licensee;
- (c) can be shown by written documentation to have already been in Licensor's or Inventor's possession at the time of its receipt from Licensee; or
- (d) is disclosed to Licensor or Inventor by a third party without Licensor's or Inventor's knowledge of any breach of any obligation or confidentiality owed to Licensee.

#### 10. MISCELLANEOUS

10.1 All notices to, demands, consents, and communications that any Party may desire to give to the other, and/or may be required under this Agreement, must be in writing. The notice shall be effective upon receipt in the United States after having been sent by registered or certified mail or sent by facsimile transmission; and shall be effective upon receipt outside the United States after having been delivered prepaid to a reputable international delivery service or courier or sent by facsimile transmission; and addressed to the address designated below:

For notice to Licensor:

SAMUELS, GREEN, STEEL & ADAMS, LLP,  
Mr. Mark Adams, Esq.  
19800 MacArthur Blvd., Suite 1000  
Irvine, CA 92612

For notice to Licensee:

W. Alan Barker, Geneva Legal Counsel  
4240 International Parkway  
Suite 100  
Carrollton, Texas 75007  
Tel: (469) 568-2376 x112  
Fax: (469) 568-2100  
Email: abarker@genevaaerospace.com

Or to such address that the Party to whom notices are to be sent may from time to time designate in writing.

- 10.2 No failure or delay to act upon any default or to exercise any right, power or remedy under this Agreement will operate as a waiver of any such default, right, power or remedy.
- 10.3 This Agreement constitutes the entire understanding of the Parties with respect to its subject matter and supersedes all prior oral or written negotiations, agreements and understandings. This Agreement may not be modified or amended except in writing duly signed by authorized persons on behalf of the Parties.
- 10.4 The validity, construction, interpretation and performance of this Agreement, and any disputes or legal actions arising under or from this Agreement, shall be governed by the laws and regulations of the United States of America as to patent law, and the State of Delaware as applied to contracts.
- 10.5 Each of the terms and provisions of this Agreement is material. Without such terms and provisions the Parties would not have entered into this Agreement. If any term or provision of this Agreement is, becomes, or is deemed invalid, illegal or unenforceable under the applicable laws or regulations in the United States or any of its jurisdictions including, for example, the State of Delaware, such term or provision may be amended, by mutual agreement between Licensor and Licensee, to the extent necessary to conform to applicable laws or regulations without materially altering the intention of the parties or, if it cannot be so amended by good-faith negotiations and agreement between Licensor and Licensee then this Agreement shall be terminated sixty (60) days following such term or provision becoming or being deemed invalid, illegal or unenforceable.
- 10.6 This Agreement does not constitute either Party the agent of the other Party for any purpose whatsoever, nor does either Party have the right or authority to assume, create or incur any liability of any kind, express or implied, against or in the name or on behalf of the other Party.
- 10.7 The English language form of this Agreement shall control and determine its interpretation.

IN WITNESS WHEREOF, the parties hereto have caused this RPV License Agreement to be executed by their respective duly authorized officers as of the Effective Date.

OPTIMA TECHNOLOGY INC.

Date: May 01, 2006

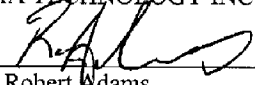
By:   
Robert Adams  
As CEO, Optima Technology Inc.

Date: May 25, 2006.

By:   
Jed Margolin  
Inventor

GENEVA AEROSPACE®, INC.

Date: May 17, 2006.

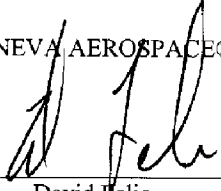
By:   
David Helio  
As CEO/President  
Geneva Aerospace, Inc.

This Agreement shall not be effective unless an original or a fax copy of this signature page fully executing this Agreement is received by Licensor within twenty-one (21) Days of the Effective Date.

Exhibit A

**Optima Technology**  
**Proprietary & Confidential**  
**Information**

*[Redacted]*



Commercial Price List

**Exhibit B**

Geneva P/N	Name	Description	List Price
<b>Flight Controls</b>			
606-0022-001	flightTEK for Fixed Wing No Navigator	flightTEK computer with internal GPS and fixed wing VACS software. No cabling or GPS antenna.	\$ 11,900.00
606-0023-001	flightTEK for Airship No Navigator	flightTEK computer with internal GPS and airship VACS software. No cabling or GPS antenna.	\$ 20,500.00
606-0022-002	flightTEK Extended Use	Same as above with the addition of a web interface that permits the customer to modify the autopilot gains.	\$ 11,900.00
606-0023-002	flightTEK Airship Extended Use	Same as above with the addition of a web interface that permits the customer to modify the autopilot gains.	\$ 20,500.00
606-0024-001	flightTEK Standard Cable Set	Standard cable set not including the GPS RF cable. Cable is based on Dakota configuration.	\$ 2,900.00
606-0025-001	flightTEK PIL Cable Set	Standard bench cable that breaks out all of the flightTEK interfaces	\$ 1,200.00
606-0026-001	flightTEK Custom Cable Set Design	Non-standard cable set design to interface to special payloads or other airborne components. Comes with a single cable set to aid in fit checks and integration.	\$ 23,000.00
Defined at design	flightTEK Custom Cable Set	Single cable set designed to specifications from the custom cable set design effort	\$ 3,100.00
606-0027-002	flightTEK GPS Antenna	Active GPS antenna and TBD II, RF cable	\$ 490.00
<b>flightTEK VACS Software Options</b>			
820-0011-001	Navigator Software	15 state Kalman filter that provides the full navigation slate.	\$ 1,000.00
606-0068-001	SIL 6DOF SDK	Development environment that supports the extended use flightTEK. Allows the user to create a model of the aircraft and test the flightTEK gain settings against the airframe model. Includes a pre-compiled library for use on a ??? OS and Visual C++ compiler environment.	\$ 15,000.00
606-0050-001	PILHIL 6DOF SDK System	Development environment that supports the extended use flightTEK. Allows the user to create a model of the aircraft and test the flightTEK gain settings against the airframe model in a real-time PILHIL environment. Includes a pre-compiled library for use on a Linux OS and a preloaded Box PC.	\$ 5,000.00
<b>flightTEK IMU/INS</b>			
606-0028-001	Systron Donner CMIGITS III INS	Includes the CMIGITS hardware and the software interface driver	\$ 30,850.00
606-0029-001	CMIGITS Mount w/ 12v/28v DC-DC converter	Standard Dakota mount with interface cable and 12v/28v DC-DC power converter	\$ 2,000.00
606-0030-001	CMIGITS Mount (28v)	Standard Dakota mount with interface cable without power converter (28v)	\$ 1,500.00
606-0031-001	Systron Donner MMQ IMU Assembly	Includes the MMQ hardware, LVDS board converter, TBD in, cable between MMQ and LVDS board, and the software interface driver	\$ 7,200.00
606-0032-001	Crossbow IMU	Includes the Crossbow hardware and the software interface driver	\$ 4,900.00
606-0033-001	Microstrain IMU	Includes Microstrain hardware and the software interface driver	\$ 1,900.00
606-0065-001	Interface Panel	Includes ADS sensor, RC to autonomous flight switching, FTS interface	\$ 7,000.00
606-0035-001	ADS Sensor - Setra	ADS sensor w/ tubing - Setra	\$ 550.00
606-0035-002	ADS Sensor - All Sensors	ADS sensor w/ tubing - All Sensors	\$ 550.00
<b>Data Link for Air Vehicles</b>			
606-0036-001	linkTEK DV	Transmits data & video via 802.11b for LOS or via optional satcom link for BLOS. Video is transmitted as digital data compressed using JPEG2000 compression. 4 ethernet ports on an internal switch are provided. If flightTEK is used, one ethernet port will be used. 1 watt internal power amp for 802.11b is included.	\$ 9,950.00
606-0036-002	linkTEK DV No Amp	Same as linkTEK DV but does not include internal 802.11b power amp.	\$ 8,600.00
606-0037-001	linkTEK D	Same as linkTEK DV but does not include video.	\$ 9,200.00
606-0037-002	linkTEK D No Amp	Same as linkTEK DV No Amp but does not include video.	\$ 8,000.00
606-0038-001	SATCOM - 1	Satcom modem enclosure with a single GlobalStar modem, TBD in, of RF cable, 24 in. serial interface cable, and a single GlobalStar antenna.	\$ 4,400.00
606-0038-002	SATCOM - 2	Satcom modem enclosure with two GlobalStar modems, TBD in, of RF cables, 24 in. serial interface cable, and two GlobalStar antennas.	\$ 7,200.00
606-0041-001	linkTEK Developer Kit	Power cable, power supply, and RJ45 cable, and 3' rubber duck antenna.	\$ 950.00
606-0039-001	Serial Datalink 225-400 MHz	Radio hardware with TBD in, RF cable and vehicle antenna	\$ 5,200.00
606-0040-001	Serial Datalink 900 MHz	Radio hardware with TBD in, RF cable and vehicle antenna	\$ 1,750.00
606-0042-001	Serial Datalink Developer Kit	Power cable, power supply, and RJ45 cable, and 3' rubber duck antenna.	\$ 950.00
<b>Control Stations</b>			
820-0012-001	missionTEK Software	Runs on Windows 2000, NT, or XP. Capable of commanding all available flight modes.	\$ 15,000.00
606-0010-001	missionTEK Computer	Includes a Panasonic Toughbook, mouse, and joystick.	\$ 4,500.00
606-0069-001	missionTEK Synthetic Image Module	This product is an interface module that enables missionTEK support unmanned vehicle operator situational awareness aids. The product provides an interface to the AAcuity® PC-IG System sold by SDS International. The product requires missionTEK to be connected to the PC-IG system through an Ethernet connection and provides the PC-IG system periodic vehicle data that is used to generate a synthetic image of the vehicle relative to a 3-D terrain environment.	\$ 2,000.00
606-0037-003	linkTEK D - GCS	Same as linkTEK D for the air vehicle and includes power supply, power cable, interface cables, and 3' quarter wave rubber duck antenna.	\$ 9,700.00
606-0037-004	linkTEK D No Amp - GCS	Same as linkTEK D - GCS except no 802.11b power amp.	\$ 9,000.00
606-0038-003	SATCOM - 1 - GCS	Satcom modem enclosure with a single GlobalStar modem, TBD in, of RF cable, 24 in. serial interface cable, and a single GlobalStar antenna.	\$ 5,200.00
606-0038-004	SATCOM - 2 - GCS	Same as SATCOM - 1 except an additional GlobalStar modem, RF cable, and antenna is included.	\$ 8,600.00
606-0043-001	linkTEK Comm Kit	802.11b antenna, RF cables, antenna masts,	\$ 1,250.00
606-0039-002	Serial Datalink 225-400 MHz - GCS	225-400 MHz radio hardware in ruggedized enclosure with ground power cord	\$ 4,600.00
606-0040-002	Serial Datalink 900 MHz - GCS	900 MHz radio hardware in ruggedized enclosure with ground power cord	\$ 2,000.00
501-xxxx-xxx	linkTEK / Serial Datalink Interface Cable	Interface cable required when using linkTEK to support multi-vehicle control	\$ 130.00
606-0043-002	Serial Datalink Comm Kit	900 MHz Omni antenna, 3dB Omnidirectional UHF antenna, 30' RF cable, antenna masts, mast mounting kit, mast stand	\$ 950.00
606-0051-001	Ground Control Station - Packaged Option	GCS Box with power supply and integrated with purchased Control Station Components	\$ 1,900.00
<b>Flight Termination</b>			
606-0044-001	safeTEK Air	Receiver, backup battery pack, TBD in, RF cable, and antenna	\$ 4,500.00
602-0042-001	safeTEK Ground	Rack mount with ability to independently command 3 safeTEK air units. Comes with power cord.	\$ 8,750.00
606-0043-003	safeTEK Ground Comm Kit	Antenna, RF cable, mast	\$ 1,950.00

1  
2

**Exhibit 4** - Public Records from Palm Beach County, Florida



1



CFN 20060462327  
OR BK 20706 PG 0325  
RECORDED 08/08/2006 15:46:06  
Palm Beach County, Florida  
ART 1, 012, 602.00  
Doc Stamp 7, 088.90  
Sharon R. Bock, CLERK & COMPTROLLER  
Pgs 0325 - 326; (2pgs)

RETURN TO:  
NOVA TITLE COMPANY  
1401 UNIVERSITY DR. SUITE 402  
CORAL SPRINGS, FL 33071-9909  
(954) 755-9889

W/C  
94

**SPECIAL WARRANTY DEED**

THIS INDENTURE is made this 03 day of August, 2006, between BOYNTON BEACH ASSOCIATES XVI, LLLP, a Florida limited liability limited partnership ("Seller") whose post office address is 1600 Sawgrass Corporate Parkway, Suite 300, Sunrise, Florida 33323, and Jean Bruner Jeanglaude and Gertrude Arthur-Jeanglaude, husband and wife ("Buyer"), whose Social Security Numbers are \_\_\_\_\_ and \_\_\_\_\_, respectively, and whose post office address is 8671 Thornbrook Terrace Point, Boynton Beach, Florida 33437.

WITNESSETH, that Seller, for and in consideration of the sum of TEN AND NO/100 DOLLARS (\$10.00) and other good and valuable consideration to Seller in hand paid by Buyer, the receipt and sufficiency of which are hereby acknowledged, has granted, bargained and sold, and hereby grants, bargains and sells to Buyer, and Buyer's heirs, successors and assigns forever, the following described land, with a Property Appraiser's Identification Number of 00 42 45 32 03 000 1170.

Lot 117, CANYON ISLES - PLAT ONE, according to the plat thereof, as recorded in Plat Book 105 at Page 1, of the Public Records of Palm Beach County, Florida.

THIS CONVEYANCE AND TITLE TO SAID PROPERTY is subject to: (a) taxes and assessments for the present year and subsequent years, including, but not limited to, pending and certified county or municipal improvement liens; (b) restrictions, reservations, conditions, limitations, easements and other matters of record or imposed by governmental authorities having jurisdiction or control over the subject property, but this reference shall not operate to reimpose any of same; (c) all laws, ordinances, regulations, restrictions, prohibitions and other requirements imposed by governmental authorities, including, but not limited to, all applicable zoning, building, bulkhead, land use and environmental ordinances, rules and regulations, and rights or interests vested in the United States of America and/or the State of Florida; (d) those certain covenants, restrictions, agreements and lien rights set forth in Exhibit "A" attached hereto and by this reference made a part hereof; (e) the Declaration of Covenants, Restrictions and Easements for Canyon Isles, dated January 18, 2006 and recorded January 20, 2006 in Official Records Book 19820, at Page 216 of the Public Records of Palm Beach County, Florida, as amended and/or supplemented from time to time; (f) the plat of Canyon Isles - Plat One, as recorded in Plat Book 105, at Page 1 of the Public Records of Palm Beach County, Florida; (g) the plat of Canyon Isles - Plat Two, as recorded in Plat Book 105, at Page 40 of the Public Records of Palm Beach County, Florida; and (h) the plat of Canyon Isles - Plat Three, as recorded in Plat Book 106, at Page 61 of the Public Records of Palm Beach County, Florida.

SELLER does hereby specially warrant the title to said land, subject to the foregoing matters, and will defend same against the lawful claims of all persons claiming by, through or under Seller and no others.

IN WITNESS WHEREOF, Seller has hereunto set Seller's hand and seal the day and year first above written.

WITNESSES:

BOYNTON BEACH ASSOCIATES XVI, LLLP, a Florida limited liability limited partnership

By: Boynton Beach XVI Corporation, a Florida corporation, its general partner

Print Name of Witness: N. Maria Menendez

By:   
N. Maria Menendez, Vice President

Print Name of Witness: Evelyn Duenas

STATE OF FLORIDA  
COUNTY OF BROWARD

The foregoing instrument was acknowledged before me this 03 day of August, 2006, by N. Maria Menendez, as Vice President of Boynton Beach XVI Corporation, a Florida corporation, the general partner of Boynton Beach Associates XVI, LLLP, a Florida limited liability limited partnership, on behalf of said corporation and limited liability limited partnership. She is personally known to me.

Notary Public  
My Commission Expires:

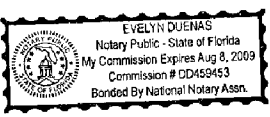

This instrument prepared by:  
HENRY W. JOHNSON, ESQ.  
HUME & JOHNSON, P.A.  
1401 University Drive, #301  
Coral Springs, Florida 33071  
(954) 755-9880

2

**EXHIBIT "A"**  
**COVENANTS, RESTRICTIONS, AGREEMENTS AND LIEN RIGHTS**

The title to the property described in the Special Warranty Deed to which this **Exhibit "A"** is attached (the "Deed") shall be subject to and burdened by the covenants, restrictions, agreements and lien rights set forth below:

1. **Capitalized Terms and Definitions.** All initial capitalized terms used in this **Exhibit "A"** but not defined herein shall have the meanings given to such terms as set forth in the Deed. The following terms as used in this **Exhibit "A"** shall have the meanings given to such terms as set forth below.

"**Gain**" shall mean and refer to the amount, if any, by which: (i) the gross selling price of the Property (less and except: (y) the actual, documented costs of any physical improvements made by Buyer after the date of the Deed to the exterior of the home on the Property such as pools, patios, screen enclosures and extensions, and (z) the actual, documented closing costs required to be paid by Buyer in connection with the sale of the Property such as documentary stamp taxes, recording fees and/or brokerage commissions), exceeds (ii) the "Total Purchase Price" paid to Seller by Buyer pursuant to and as defined in the Purchase Contract executed by Seller and Buyer.

"**Hardship Event**" shall mean and refer to a sale, transfer, lease or sublet of the Property, as appropriate, following a divorce of the Buyers (if married to each other), death or serious disability of one or more of the Buyers, job transfer of one or more of the Buyers to a location greater than fifty (50) miles from the Property, or other reason acceptable to Seller in Seller's sole and absolute discretion, as evidenced by a written waiver of this provision given by Seller.

"**Property**" shall mean and refer to the property described in the Deed together with the improvements thereon.

"**Transfer Advertisement or Agreement**" shall mean and refer to any or all of the following: (i) any listing or advertisement for the sale or lease of the Property or any portion thereof made with a broker, in any multiple listing service, in any classified or other advertisement, or otherwise (including, without limitation, "by owner"), (ii) any agreement (verbal or written) for transfer of title to the Property to any third party, and/or (iii) any agreement (verbal or written) for the leasing and/or subletting of the Property or any portion thereof, notwithstanding anything to the contrary in the Declaration.

2. **Sales/Transfers of the Property.** In the event that Buyer sells or transfers title to the Property (directly or indirectly): (a) at any time within one (1) year following the date of the Deed, and/or (b) at any time thereafter if such sale or transfer results from a Transfer Advertisement or Agreement made or entered into within one (1) year following the date of the Deed, then except only in the event of a Hardship Event released by Seller as provided in Paragraph 4 below, Buyer shall pay to Seller from the proceeds of such sale or transfer, an amount equal to one-hundred percent (100%) of the Gain realized from such sale or transfer.

3. **No Leasing of the Property.** Notwithstanding anything to the contrary in the Declaration, for a period of one (1) year following the date of the Deed, except only in the event of a Hardship Event released by Seller as provided in paragraph 4 below, Buyer shall not lease and/or sublet the Property or any portion thereof. Any such lease and/or sublet shall be void and unenforceable. All other leases or sublets, including those resulting from such a Hardship Event, shall be subject to the terms and conditions of the Declaration.

4. **Lien Rights Releases.** There is and shall be a lien against the Property to secure Buyer's obligations set forth in this **Exhibit "A"**, which lien may be foreclosed on by Seller if Buyer breaches any of its obligations hereunder. In the event of a proposed sale, transfer, lease or sublet of the Property due to a Hardship Event, Buyer must first provide to Seller evidence of such Hardship Event acceptable to Seller in Seller's sole and absolute discretion, and if acceptable to Seller, Seller shall deliver to Buyer a written acknowledgment of the Hardship Event and waiver of Seller's rights hereunder with respect only to such sale, transfer, lease or sublet. In addition, upon written request from Buyer to Seller and payment of the Gain due to Seller in connection with any sale or transfer of the Property as provided in this **Exhibit "A"**, then Seller shall provide to Buyer a written acknowledgment of such payment and release of Seller's lien rights with respect only to such sale or transfer provided that Buyer provides Seller with evidence satisfactory to Seller in Seller's sole and absolute discretion of the amount of the Gain due, including, without limitation closing or other settlement statements. Any release provided by Seller shall be specific only to the particular sale, transfer, lease or sublet described in the release and not to any subsequent sale, transfer, lease or sublet which shall remain subject to this **Exhibit "A"**.

5. **Binding and Running with Title to the Property.** The covenants, restrictions, agreements and lien rights set forth in this **Exhibit "A"** shall burden and run with title to the Property.

6. **Remedies.** In addition to its right of foreclosure, Seller shall have all remedies at law and/or in equity for a breach by Buyer under this **Exhibit "A"**. In the event that Seller prevails in any action (legal or otherwise) to enforce its rights and/or Buyer's obligations, Seller shall be entitled to recover all of its costs incurred including, without limitation, reasonable attorneys' fees, through and including all appellate levels. By acceptance of the Deed to the Property, Buyer, for itself, and its successors and assigns waives any homestead or other exemption now or hereafter existing or enacted under either Florida or federal law as same may relate to Seller's rights hereunder.

7. **Subordination.** This **Exhibit "A"** shall be subordinate to the right of any holder of an institutional first mortgage on the Property and shall not apply to any sales or leases by an institutional first mortgagee who acquires title to the Property by foreclosure or deed in lieu of foreclosure.

8. **Miscellaneous.** This **Exhibit "A"** shall be construed in accordance with the laws of the State of Florida and shall be binding on Buyer and Buyer's heirs, successors and assigns. In that regard, all references to Buyer in this **Exhibit "A"** shall also mean and refer to each and every of Buyer's heirs, successors and/or assigns. Should any term or provision of this **Exhibit "A"** be ruled to be illegal or otherwise invalid by a court of competent jurisdiction, such term or provision shall be given its nearest legal meaning or be construed as deleted as such court determines, and the same will not invalidate the remaining terms and provisions of this **Exhibit "A"**, which terms, provisions and portions of this Contract will remain in full force and effect. This **Exhibit "A"** may not be amended or modified except by an instrument in writing executed by Seller.



RETURN TO:  
NUVA TITLE COMPANY  
1401 UNIVERSITY DR. SUITE 402  
CORAL SPRINGS, FL 33071-8909  
(954) 755-9880

CFN 20060518682  
OR BK 20826 PG 1476  
RECORDED 09/08/2006 13:31:09  
Palm Beach County, Florida  
ART 10.00  
Doc Stamp 0.70  
Sharon R. Bock, CLERK & COMPTROLLER  
Pgs 1476 - 1477; (2pgs)

**CORRECTIVE**

**SPECIAL WARRANTY DEED**

W/C 84

THIS INDENTURE is made this 5 day of September, 2006, between **BOYNTON BEACH ASSOCIATES XVI, LLLP**, a Florida limited liability limited partnership ("Seller") whose post office address is 1600 Sawgrass Corporate Parkway, Suite 300, Sunrise, Florida 33323, and Jean Bruner Jeanglaude and Gertrude Arthur Jeanglaude, husband and wife ("Buyer"), whose Social Security Numbers are \_\_\_\_\_ (and and \_\_\_\_\_, respectively, and whose post office address is 8671 Thornbrook Terrace Point, Boynton Beach, Florida 33437.

**WITNESSETH**, that Seller, for and in consideration of the sum of **TEN AND NO/100 DOLLARS (\$10.00)** and other good and valuable consideration to Seller in hand paid by Buyer, the receipt and sufficiency of which are hereby acknowledged, has granted, bargained and sold, and hereby grants, bargains and sells to Buyer, and Buyer's heirs, successors, and assigns forever, the following described land, with a Property Appraiser's Identification Number of **00 42 45 32 03 000 1170**.

**Lot 117 , CANYON ISLES - PLAT TWO, according to the plat thereof, as recorded in Plat Book 40 at Page 43, of the Public Records of Palm Beach County, Florida.**

THIS CONVEYANCE AND TITLE TO SAID PROPERTY is subject to: (a) taxes and assessments for the present year and subsequent years, including, but not limited to, pending and certified county or municipal improvement liens; (b) restrictions, reservations, conditions, limitations, easements and other matters of record or imposed by governmental authorities having jurisdiction or control over the subject property, but this reference shall not operate to reimpose any of same; (c) all laws, ordinances, regulations, restrictions, prohibitions and other requirements imposed by governmental authorities, including, but not limited to, all applicable zoning, building, bulkhead, land use and environmental ordinances, rules and regulations, and rights or interests vested in the United States of America and/or the State of Florida; (d) those certain covenants, restrictions, agreements and lien rights set forth in **Exhibit "A"** attached hereto and by this reference made a part hereof; (e) the Declaration of Covenants, Restrictions and Easements for Canyon Isles, dated January 18, 2006 and recorded January 20, 2006 in Official Records Book 19820, at Page 216 of the Public Records of Palm Beach County, Florida, as amended and/or supplemented from time to time; (f) the plat of Canyon Isles - Plat One, as recorded in Plat Book 105, at Page 1 of the Public Records of Palm Beach County, Florida; (g) the plat of Canyon Isles - Plat Two, as recorded in Plat Book 105, at Page 40 of the Public Records of Palm Beach County, Florida; and (h) the plat of Canyon Isles - Plat Three, as recorded in Plat Book 106, at Page 61 of the Public Records of Palm Beach County, Florida.

**SELLER** does hereby specially warrant the title to said land, subject to the foregoing matters, and will defend same against the lawful claims of all persons claiming by, through or under Seller and no others.

**IN WITNESS WHEREOF**, Seller has hereunto set Seller's hand and seal the day and year first above written.

WITNESSES:

**BOYNTON BEACH ASSOCIATES XVI, LLLP**, a Florida limited liability limited partnership

By: **Boynton Beach XVI Corporation**, a Florida corporation, its general partner

By: *N. Maria Menendez*  
N. Maria Menendez, Vice President

*Kathleen Bronson*  
Print Name of Witness: Kathleen Bronson

*Kathleen M Coffman*  
Print Name of Witness: Kathleen M Coffman

STATE OF FLORIDA  
COUNTY OF BROWARD

The foregoing instrument was acknowledged before me this 5 day of September, 2006, by N. Maria Menendez, as Vice President of Boynton Beach XVI Corporation, a Florida corporation, the general partner of Boynton Beach Associates XVI, LLLP, a Florida limited liability limited partnership, on behalf of said corporation and limited liability limited partnership. She is personally known to me.

*Kathleen M Coffman*  
Notary Public  
My Commission Expires:

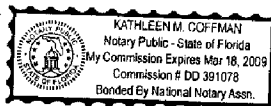

This instrument prepared by:  
**HENRY W. JOHNSON, ESQ.**  
**HUME & JOHNSON, P.A.**  
1401 University Drive, #301  
Coral Springs, Florida 33071  
(954) 755-9880

THIS DEED IS BEING RECORDED TO CORRECT THE LEGAL DESCRIPTION CONTAINED IN THE ORIGINAL DEED DATED 08/03/06 AND RECORDED 08/08/06 IN OFFICIAL RECORDS BOOK 20706 AT PAGE 325 OF THE PUBLIC RECORDS OF PALM BEACH COUNTY, FLORIDA

**EXHIBIT "A"**  
**COVENANTS, RESTRICTIONS, AGREEMENTS AND LIEN RIGHTS**

The title to the property described in the Special Warranty Deed to which this **Exhibit "A"** is attached (the "Deed") shall be subject to and burdened by the covenants, restrictions, agreements and lien rights set forth below:

1. **Capitalized Terms and Definitions.** All initial capitalized terms used in this **Exhibit "A"** but not defined herein shall have the meanings given to such terms as set forth in the Deed. The following terms as used in this **Exhibit "A"** shall have the meanings given to such terms as set forth below.

"**Gain**" shall mean and refer to the amount, if any, by which: (i) the gross selling price of the Property (less and except: (y) the actual, documented costs of any physical improvements made by Buyer after the date of the Deed to the exterior of the home on the Property such as pools, patios, screen enclosures and extensions, and (z) the actual, documented closing costs required to be paid by Buyer in connection with the sale of the Property such as documentary stamp taxes, recording fees and/or brokerage commissions), exceeds (ii) the "Total Purchase Price" paid to Seller by Buyer pursuant to and as defined in the Purchase Contract executed by Seller and Buyer.

"**Hardship Event**" shall mean and refer to a sale, transfer, lease or sublet of the Property, as appropriate, following a divorce of the Buyers (if married to each other), death or serious disability of one or more of the Buyers, job transfer of one or more of the Buyers to a location greater than fifty (50) miles from the Property, or other reason acceptable to Seller in Seller's sole and absolute discretion, as evidenced by a written waiver of this provision given by Seller.

"**Property**" shall mean and refer to the property described in the Deed together with the improvements thereon.

"**Transfer Advertisement or Agreement**" shall mean and refer to any or all of the following: (i) any listing or advertisement for the sale or lease of the Property or any portion thereof made with a broker, in any multiple listing service, in any classified or other advertisement, or otherwise (including, without limitation, "by owner"), (ii) any agreement (verbal or written) for transfer of title to the Property to any third party, and/or (iii) any agreement (verbal or written) for the leasing and/or subletting of the Property or any portion thereof, notwithstanding anything to the contrary in the Declaration.

2. **Sales/Transfers of the Property.** In the event that Buyer sells or transfers title to the Property (directly or indirectly): (a) at any time within one (1) year following the date of the Deed, and/or (b) at any time thereafter if such sale or transfer results from a Transfer Advertisement or Agreement made or entered into within one (1) year following the date of the Deed, then except only in the event of a Hardship Event released by Seller as provided in Paragraph 4 below, Buyer shall pay to Seller from the proceeds of such sale or transfer, an amount equal to one-hundred percent (100%) of the **Gain** realized from such sale or transfer.

3. **No Leasing of the Property.** Notwithstanding anything to the contrary in the Declaration, for a period of one (1) year following the date of the Deed, except only in the event of a Hardship Event released by Seller as provided in paragraph 4 below, Buyer shall not lease and/or sublet the Property or any portion thereof. Any such lease and/or sublet shall be void and unenforceable. All other leases or sublets, including those resulting from such a Hardship Event, shall be subject to the terms and conditions of the Declaration.

4. **Lien Rights: Releases.** There is and shall be a lien against the Property to secure Buyer's obligations set forth in this **Exhibit "A"**, which lien may be foreclosed on by Seller if Buyer breaches any of its obligations hereunder. In the event of a proposed sale, transfer, lease or sublet of the Property due to a Hardship Event, Buyer must first provide to Seller evidence of such Hardship Event acceptable to Seller in Seller's sole and absolute discretion, and if acceptable to Seller, Seller shall deliver to Buyer a written acknowledgment of the Hardship Event and waiver of Seller's rights hereunder with respect only to such sale, transfer, lease or sublet. In addition, upon written request from Buyer to Seller and payment of the **Gain** due to Seller in connection with any sale or transfer of the Property as provided in this **Exhibit "A"**, then Seller shall provide to Buyer a written acknowledgment of such payment and release of Seller's lien rights with respect only to such sale or transfer provided that Buyer provides Seller with evidence satisfactory to Seller in Seller's sole and absolute discretion of the amount of the **Gain** due, including, without limitation closing or other settlement statements. Any release provided by Seller shall be specific only to the particular sale, transfer, lease or sublet described in the release and not to any subsequent sale, transfer, lease or sublet which shall remain subject to this **Exhibit "A"**.

5. **Binding and Running with Title to the Property.** The covenants, restrictions, agreements and lien rights set forth in this **Exhibit "A"** shall burden and run with title to the Property.

6. **Remedies.** In addition to its right of foreclosure, Seller shall have all remedies at law and/or in equity for a breach by Buyer under this **Exhibit "A"**. In the event that Seller prevails in any action (legal or otherwise) to enforce its rights and/or Buyer's obligations, Seller shall be entitled to recover all of its costs incurred including, without limitation, reasonable attorneys' fees, through and including all appellate levels. By acceptance of the Deed to the Property, Buyer, for itself, and its successors and assigns waives any homestead or other exemption now or hereafter existing or enacted under either Florida or federal law as same may relate to Seller's rights hereunder.

7. **Subordination.** This **Exhibit "A"** shall be subordinate to the right of any holder of an institutional first mortgage on the Property and shall not apply to any sales or leases by an institutional first mortgagee who acquires title to the Property by foreclosure or deed in lieu of foreclosure.

8. **Miscellaneous.** This **Exhibit "A"** shall be construed in accordance with the laws of the State of Florida and shall be binding on Buyer and Buyer's heirs, successors and assigns. In that regard, all references to Buyer in this **Exhibit "A"** shall also mean and refer to each and every of Buyer's heirs, successors and/or assigns. Should any term or provision of this **Exhibit "A"** be ruled to be illegal or otherwise invalid by a court of competent jurisdiction, such term or provision shall be given its nearest legal meaning or be construed as deleted as such court determines, and the same will not invalidate the remaining terms and provisions of this **Exhibit "A"**, which terms, provisions and portions of this Contract will remain in full force and effect. This **Exhibit "A"** may not be amended or modified except by an instrument in writing executed by Seller.



RETURN TO:  
NOVA TITLE COMPANY  
1401 UNIVERSITY DR. SUITE 402  
CORAL SPRINGS, FL 33071-8908  
(954) 755-9889

CFN 20060567208  
OR BK 20927 PG 0647  
RECORDED 10/04/2006 12:56:16  
Palm Beach County, Florida  
AMT 10.00  
Doc Stamp 0.70  
Sharon K. Beck, CLERK & COMPTROLLER  
Pgs 0647 - 648; (2pgs)

**CORRECTIVE**

**SPECIAL WARRANTY DEED**

W/C 84

THIS INDENTURE is made this 25 day of September, 2006, between **BOYNTON BEACH ASSOCIATES XVI, LLLP**, a Florida limited liability limited partnership ("Seller") whose post office address is 1600 Sawgrass Corporate Parkway, Suite 300, Sunrise, Florida 33323, and Jean Bruner Jeanglaude and Gertrude Arthur Jeanglaude, husband and wife ("Buyer"), whose Social Security Numbers are \_\_\_\_\_ and \_\_\_\_\_, respectively, and whose post office address is 8671 Thornbrook Terrace Point, Boynton Beach, Florida 33437.

WITNESSETH, that Seller, for and in consideration of the sum of TEN AND NO/100 DOLLARS (\$10.00) and other good and valuable consideration to Seller in hand paid by Buyer, the receipt and sufficiency of which are hereby acknowledged, has granted, bargained and sold, and hereby grants, bargains and sells to Buyer, and Buyer's heirs, successors and assigns forever, the following described land, with a Property Appraiser's Identification Number of 00424532030001170.

Lot 117, CANYON ISLES - PLAT TWO, according to the plat thereof, as recorded in Plat Book 105 at Page 40, of the Public Records of Palm Beach County, Florida.

THIS CONVEYANCE AND TITLE TO SAID PROPERTY is subject to: (a) taxes and assessments for the present year and subsequent years, including, but not limited to, pending and certified county or municipal improvement liens; (b) restrictions, reservations, conditions, limitations, easements and other matters of record or imposed by governmental authorities having jurisdiction or control over the subject property, but this reference shall not operate to reimpose any of same; (c) all laws, ordinances, regulations, restrictions, prohibitions and other requirements imposed by governmental authorities, including, but not limited to, all applicable zoning, building, bulkhead, land use and environmental ordinances, rules and regulations, and rights or interests vested in the United States of America and/or the State of Florida; (d) those certain covenants, restrictions, agreements and lien rights set forth in Exhibit "A" attached hereto and by this reference made a part hereof; (e) the Declaration of Covenants, Restrictions and Easements for Canyon Isles, dated January 18, 2006 and recorded January 20, 2006 in Official Records Book 19820, at Page 216 of the Public Records of Palm Beach County, Florida, as amended and/or supplemented from time to time; (f) the plat of Canyon Isles - Plat One, as recorded in Plat Book 105, at Page 1 of the Public Records of Palm Beach County, Florida; (g) the plat of Canyon Isles - Plat Two, as recorded in Plat Book 105, at Page 40 of the Public Records of Palm Beach County, Florida; and (h) the plat of Canyon Isles - Plat Three, as recorded in Plat Book 106, at Page 61 of the Public Records of Palm Beach County, Florida.

SELLER does hereby specially warrant the title to said land, subject to the foregoing matters, and will defend same against the lawful claims of all persons claiming by, through or under Seller and no others.

IN WITNESS WHEREOF, Seller has hereunto set Seller's hand and seal the day and year first above written.

WITNESSES:

BOYNTON BEACH ASSOCIATES XVI, LLLP, a Florida limited liability limited partnership

By: Boynton Beach XVI Corporation, a Florida corporation, its general partner

By: N. Maria Menendez  
N. Maria Menendez, Vice President

Alamy D...  
Print Name of Witness: Alamy D...

Kathleen M Coffman  
Print Name of Witness: Kathleen M Coffman

STATE OF FLORIDA  
COUNTY OF BROWARD

The foregoing instrument was acknowledged before me this 25 day of September, 2006, by N. Maria Menendez, as Vice President of Boynton Beach XVI Corporation, a Florida corporation, the general partner of Boynton Beach Associates XVI, LLLP, a Florida limited liability limited partnership, on behalf of said corporation and limited liability limited partnership. She is personally known to me.

Kathleen M Coffman  
Notary Public  
My Commission Expires:



This instrument prepared by:  
**HENRY W. JOHNSON, ESQ.**  
**HUME & JOHNSON, P.A.**  
1401 University Drive, #301  
Coral Springs, Florida 33071  
(954) 755-9880

THIS DEED IS BEING RECORDED TO CORRECT THE LEGAL DESCRIPTION CONTAINED IN THE CORRECTIVE DEED DATED SEPTEMBER 5, 2006 AND RECORDED SEPTEMBER 8, 2006 in ORBOOK 20826 AT PAGE 1476 OF THE PUBLIC RECORDS OF PALM BEACH COUNTY, FLORIDA

**EXHIBIT "A"**  
**COVENANTS, RESTRICTIONS, AGREEMENTS AND LIEN RIGHTS**

The title to the property described in the Special Warranty Deed to which this **Exhibit "A"** is attached (the "Deed") shall be subject to and burdened by the covenants, restrictions, agreements and lien rights set forth below:

1. **Capitalized Terms and Definitions.** All initial capitalized terms used in this **Exhibit "A"** but not defined herein shall have the meanings given to such terms as set forth in the Deed. The following terms as used in this **Exhibit "A"** shall have the meanings given to such terms as set forth below.

"**Gain**" shall mean and refer to the amount, if any, by which: (i) the gross selling price of the Property (less and except: (y) the actual, documented costs of any physical improvements made by Buyer after the date of the Deed to the exterior of the home on the Property such as pools, patios, screen enclosures and extensions, and (z) the actual, documented closing costs required to be paid by Buyer in connection with the sale of the Property such as documentary stamp taxes, recording fees and/or brokerage commissions), exceeds (ii) the "Total Purchase Price" paid to Seller by Buyer pursuant to and as defined in the Purchase Contract executed by Seller and Buyer.

"**Hardship Event**" shall mean and refer to a sale, transfer, lease or sublet of the Property, as appropriate, following a divorce of the Buyers (if married to each other), death or serious disability of one or more of the Buyers, job transfer of one or more of the Buyers to a location greater than fifty (50) miles from the Property, or other reason acceptable to Seller in Seller's sole and absolute discretion, as evidenced by a written waiver of this provision given by Seller.

"**Property**" shall mean and refer to the property described in the Deed together with the improvements thereon.

"**Transfer Advertisement or Agreement**" shall mean and refer to any or all of the following: (i) any listing or advertisement for the sale or lease of the Property or any portion thereof made with a broker, in any multiple listing service, in any classified or other advertisement, or otherwise (including, without limitation, "by owner"), (ii) any agreement (verbal or written) for transfer of title to the Property to any third party, and/or (iii) any agreement (verbal or written) for the leasing and/or subletting of the Property or any portion thereof, notwithstanding anything to the contrary in the Declaration.

2. **Sales/Transfers of the Property.** In the event that Buyer sells or transfers title to the Property (directly or indirectly): (a) at any time within one (1) year following the date of the Deed, and/or (b) at any time thereafter if such sale or transfer results from a Transfer Advertisement or Agreement made or entered into within one (1) year following the date of the Deed, then except only in the event of a Hardship Event released by Seller as provided in Paragraph 4 below, Buyer shall pay to Seller from the proceeds of such sale or transfer, an amount equal to one-hundred percent (100%) of the Gain realized from such sale or transfer.

3. **No Leasing of the Property.** Notwithstanding anything to the contrary in the Declaration, for a period of one (1) year following the date of the Deed, except only in the event of a Hardship Event released by Seller as provided in paragraph 4 below, Buyer shall not lease and/or sublet the Property or any portion thereof. Any such lease and/or sublet shall be void and unenforceable. All other leases or sublets, including those resulting from such a Hardship Event, shall be subject to the terms and conditions of the Declaration.

4. **Lien Rights: Releases.** There is and shall be a lien against the Property to secure Buyer's obligations set forth in this **Exhibit "A"**, which lien may be foreclosed on by Seller if Buyer breaches any of its obligations hereunder. In the event of a proposed sale, transfer, lease or sublet of the Property due to a Hardship Event, Buyer must first provide to Seller evidence of such Hardship Event acceptable to Seller in Seller's sole and absolute discretion, and if acceptable to Seller, Seller shall deliver to Buyer a written acknowledgment of the Hardship Event and waiver of Seller's rights hereunder with respect only to such sale, transfer, lease or sublet. In addition, upon written request from Buyer to Seller and payment of the Gain due to Seller in connection with any sale or transfer of the Property as provided in this **Exhibit "A"**, then Seller shall provide to Buyer a written acknowledgment of such payment and release of Seller's lien rights with respect only to such sale or transfer provided that Buyer provides Seller with evidence satisfactory to Seller in Seller's sole and absolute discretion of the amount of the Gain due, including, without limitation closing or other settlement statements. Any release provided by Seller shall be specific only to the particular sale, transfer, lease or sublet described in the release and not to any subsequent sale, transfer, lease or sublet which shall remain subject to this **Exhibit "A"**.

5. **Binding and Running with Title to the Property.** The covenants, restrictions, agreements and lien rights set forth in this **Exhibit "A"** shall burden and run with title to the Property.

6. **Remedies.** In addition to its right of foreclosure, Seller shall have all remedies at law and/or in equity for a breach by Buyer under this **Exhibit "A"**. In the event that Seller prevails in any action (legal or otherwise) to enforce its rights and/or Buyer's obligations, Seller shall be entitled to recover all of its costs incurred including, without limitation, reasonable attorneys' fees, through and including all appellate levels. By acceptance of the Deed to the Property, Buyer, for itself, and its successors and assigns waives any homestead or other exemption now or hereafter existing or enacted under either Florida or federal law as same may relate to Seller's rights hereunder.

7. **Subordination.** This **Exhibit "A"** shall be subordinate to the right of any holder of an institutional first mortgage on the Property and shall not apply to any sales or leases by an institutional first mortgagee who acquires title to the Property by foreclosure or deed in lieu of foreclosure.

8. **Miscellaneous.** This **Exhibit "A"** shall be construed in accordance with the laws of the State of Florida and shall be binding on Buyer and Buyer's heirs, successors and assigns. In that regard, all references to Buyer in this **Exhibit "A"** shall also mean and refer to each and every of Buyer's heirs, successors and/or assigns. Should any term or provision of this **Exhibit "A"** be ruled to be illegal or otherwise invalid by a court of competent jurisdiction, such term or provision shall be given its nearest legal meaning or be construed as deleted as such court determines, and the same will not invalidate the remaining terms and provisions of this **Exhibit "A"**, which terms, provisions and portions of this Contract will remain in full force and effect. This **Exhibit "A"** may not be amended or modified except by an instrument in writing executed by Seller.



RETURN TO:  
 NUX & FINANCIAL COMPANY  
 1401 UNIVERSITY DRIVE SUITE 402  
 CORAL SPRINGS, FL 33071-3908  
 (954) 756-8800

This instrument prepared by:  
 John Hume, Esq.  
 Hume & Johnson P.A.  
 1401 University Drive, Suite 402  
 Coral Springs, Florida 33071

CFN 20060567209  
 OR BK 20927 PG 0649  
 RECORDED 10/04/2006 12:56:16  
 Palm Beach County, Florida  
 Sharon R. Bock, CLERK & COMPTROLLER  
 Pg 0649; (1pg)

W/MC 84

CORRECTION AND RATIFICATION AGREEMENT

AGREEMENT made this 26 day of 09/10/06, by JEAN BRUNER JEANGLAUBE AND GERTRUDE ARTHUR JEANGLAUBE, husband and wife ("Borrowers"), whose post office address is 8671 Thornbrook Terrace Point, BOYNTON BEACH, FLORIDA 33437.

Recitals:

- A. Borrowers are the owners of the real property located at , 8671 Thornbrook Terrace Point Boynton Beach, Florida 33437 more particularly described as follows: Lot 117, CANYON ISLES PLAT TWO, according to the plat thereof, as recorded in Plat Book 105 at Page 40 of the Public Records of Palm Beach County, Florida
- B. Borrowers acquired title to the property by Warranty Deed dated September 5, 2006 and recorded September 8, 2006 in Official Records Book 20826 at Page 1476 of the Public Records of Palm Beach County, Florida.
- C. In conjunction with their purchase of the property, Borrowers encumbered the property with a mortgage in favor of GL FINANCIAL SERVICES, LLC., which mortgage secured a loan in the amount of \$650,000.00. The mortgage was dated August 3, 2006 and recorded August 8, 2006 in Official Records Book 20706 at Page 0327 of the Public Records of Palm Beach County, Florida.

D. RECORDED WITH INCORRECT LEGAL DESCRIPTION

THEREFORE, in consideration of the original mortgage loan and for other good and valuable considerations, the receipt of which is hereby acknowledged, Borrowers agree as follows:

- 1. Recitals. The above recitals are true and correct.
- 2. Correction. (INCORRECT LEGAL DESCRIPTION):

3. Ratification. Except as otherwise modified herein, all of the original terms and provisions of the mortgage are hereby ratified and confirmed and incorporated herein by reference.

Witnesses:

Ella Katz  
 Ella Katz  
PRINTED NAME OF WITNESS

Mary Laboul  
 Mary Laboul  
PRINTED NAME OF WITNESS

Jean Bruner Jeanglaube  
 JEAN BRUNER JEANGLAUBE

Gertrude Arthur Jeanglaube  
 GERTRUDE ARTHUR JEANGLAUBE

STATE OF FLORIDA  
 COUNTY OF BROWARD

The foregoing instrument was acknowledged before me this 26 day of September, 2006 by JEAN BRUNER JEANGLAUBE AND GERTRUDE ARTHUR JEANGLAUBE, who are personally known to me or produced drivers licenses as identification.

My commission expires:

Maurcen E. Roxberry  
 Notary Public, State of Florida





1400 UNIVERSITY DRIVE  
CORAL SPRINGS, FL 33071-3900  
(954) 776-0880

CFN 20060567210  
CR BK 20927 PG 0650  
RECORDED 10/04/2006 12:56:16  
Palm Beach County, Florida  
Sharon R. Hock, CLERK & COMPTROLLER  
Pg 0650; (1pg)

This instrument prepared by:  
John Hume, Esq.  
Hume & Johnson P.A.  
1400 University Drive, Suite 402  
Coral Springs, Florida 33071

W/C 84

CORRECTION AND RATIFICATION AGREEMENT

AGREEMENT made this 26 day of 09/06 by JEAN BRUNER JEANGLAUBE AND GERTRUDE ARTHUR JEANGLAUBE, husband and wife ("Borrowers"), whose post office address is 8671 Thornbrook Terrace Point, BOYNTON BEACH, FLORIDA 33437.

Recitals:

A. Borrowers are the owners of the real property located at , 8671 Thornbrook Terrace Point Boynton Beach, Florida 33437 more particularly described as follows: Lot 117, CANYON ISLES PLAT W/C, according to the plat thereof, as recorded in Plat Book 105 at Page 40 of the Public Records of Palm Beach County, Florida

B. Borrowers acquired title to the property by Warranty Deed dated September 5, 2006 and recorded September 8, 2006 in Official Records Book 20826 at Page 1476 of the Public Records of Palm Beach County, Florida.

C. In conjunction with their purchase of the property, Borrowers encumbered the property with a mortgage in favor of GL FINANCIAL SERVICES, LLC., which mortgage secured a loan in the amount of \$141,120.00. The mortgage was dated August 3, 2006 and recorded August 8, 2006 in Official Records Book 20706 at Page 0344 of the Public Records of Palm Beach County, Florida.

D. RECORDED WITH INCORRECT LEGAL DESCRIPTION

THEREFORE, in consideration of the original mortgage loan and for other good and valuable considerations, the receipt of which is hereby acknowledged, Borrowers agree as follows:

1. Recitals. The above recitals are true and correct.
2. Correction. (INCORRECT LEGAL DESCRIPTION):
3. Ratification. Except as otherwise modified herein, all of the original terms and provisions of the mortgage are hereby ratified and confirmed and incorporated herein by reference.

Witnesses:

Ella Katz  
Ella Katz  
PRINTED NAME OF WITNESS

Mary Campbell  
Mary Campbell  
PRINTED NAME OF WITNESS

Jean Bruner Jeanglaube  
JEAN BRUNER JEANGLAUBE

Gertrude Arthur Jeanglaube  
GERTRUDE ARTHUR JEANGLAUBE

STATE OF FLORIDA  
COUNTY OF BROWARD

The foregoing instrument was acknowledged before me this 26<sup>th</sup> day of September, 2006 by JEAN BRUNER JEANGLAUBE AND GERTRUDE ARTHUR JEANGLAUBE, who are personally known to me or produced drivers license as identification.

My commission expires:

Maureen E. Roxberry  
Commission #DD299658  
Expires: Mar 11, 2008  
Bonded Thru  
Atlantic Bonding Co., Inc.

[Signature]  
Notary Public, State of Florida





2

WIC 84

After Recording Return To:  
COUNTRYWIDE HOME LOANS, INC.  
MS SV-79 DOCUMENT PROCESSING  
P.O.Box 10423  
Van Nuys, CA 91410-0423  
This document was prepared by:  
YVETTE ZAPATA  
GL FINANCIAL SERVICES, LLC.

CFN 20060462328  
DR BK 20706 PG 0327  
RECORDED 08/08/2006 15:46:06  
PALM Beach County, Florida  
AMT 650,000.00  
DEBT Doc 2, 275.00  
Intang 1, 300.00  
Sharon R. Bock, CLERK & COMPTROLLER  
Pgs 0327 - 343; (17pgs)

210 N. UNIVERSITY DR STE 601  
CORAL SPRINGS, FL 33071

[Space Above This Line For Recording Data]

00013884537607006  
(Doc ID #)

MORTGAGE

MIN 1000157-0006863972-9

DEFINITIONS

Words used in multiple sections of this document are defined below and other words are defined in Sections 3, 11, 13, 18, 20 and 21. Certain rules regarding the usage of words used in this document are also provided in Section 16.

(A) "Security Instrument" means this document, which is dated AUGUST 03, 2006, together with all Riders to this document.

(B) "Borrower" is  
JEAN B JEANGLAUDE, AND GERTRUDE ARTHUR-JEANGLAUDE, HUSBAND AND WIFE

Borrower is the mortgagor under this Security Instrument.

(C) "MERS" is Mortgage Electronic Registration Systems, Inc. MERS is a separate corporation that is acting solely as a nominee for Lender and Lender's successors and assigns. MERS is the mortgagee under this Security Instrument. MERS is organized and existing under the laws of Delaware, and has an address and telephone number of P.O. Box 2026, Flint, MI 48501-2026, tel. (888) 679-MERS.

(D) "Lender" is  
GL FINANCIAL SERVICES, LLC.

Lender is a BANK  
organized and existing under the laws of FLORIDA

Lender's address is  
210 N. UNIVERSITY DR STE 601, CORAL SPRINGS, FL 33071

(E) "Note" means the promissory note signed by Borrower and dated AUGUST 03, 2006. The Note states that Borrower owes Lender

SIX HUNDRED FIFTY THOUSAND and 00/100

Dollars (U.S. \$ 650,000.00) plus interest. Borrower has promised to pay this debt in regular Periodic Payments and to pay the debt in full not later than SEPTEMBER 01, 2036.

(F) "Property" means the property that is described below under the heading "Transfer of Rights in the Property."

FLORIDA-Single Family Fannie Mae/Freddie Mac UNIFORM INSTRUMENT WITH MERS

Page 1 of 11

GA(FL) (0005) CHL (08/05)(d) VMP Mortgage Solutions, Inc. (800)521-7291  
CONV/VA

Form 3010 1/01



\* 2 3 9 9 1 \*



\* 1 3 8 8 4 5 3 7 6 0 0 0 0 2 0 0 6 A \*

This document is a legal document and should be read carefully.

DOC ID #: 00013884537607006

(G) "Loan" means the debt evidenced by the Note, plus interest, any prepayment charges and late charges due under the Note, and all sums due under this Security Instrument, plus interest.

(H) "Riders" means all Riders to this Security Instrument that are executed by Borrower. The following Riders are to be executed by Borrower [check box as applicable]:

- Adjustable Rate Rider
- Balloon Rider
- VA Rider
- Condominium Rider
- Planned Unit Development Rider
- Biweekly Payment Rider
- Second Home Rider
- 1-4 Family Rider
- Other(s) [specify]

(I) "Applicable Law" means all controlling applicable federal, state and local statutes, regulations, ordinances and administrative rules and orders (that have the effect of law) as well as all applicable final, non-appealable judicial opinions.

(J) "Community Association Dues, Fees, and Assessments" means all dues, fees, assessments and other charges that are imposed on Borrower or the Property by a condominium association, homeowners association or similar organization.

(K) "Electronic Funds Transfer" means any transfer of funds, other than a transaction originated by check, draft, or similar paper instrument, which is initiated through an electronic terminal, telephonic instrument, computer, or magnetic tape so as to order, instruct, or authorize a financial institution to debit or credit an account. Such term includes, but is not limited to, point-of-sale transfers, automated teller machine transactions, transfers initiated by telephone, wire transfers, and automated clearinghouse transfers.

(L) "Escrow Items" means those items that are described in Section 3.

(M) "Miscellaneous Proceeds" means any compensation, settlement, award of damages, or proceeds paid by any third party (other than insurance proceeds paid under the coverages described in Section 5) for: (i) damage to, or destruction of, the Property; (ii) condemnation or other taking of all or any part of the Property; (iii) conveyance in lieu of condemnation; or (iv) misrepresentations of, or omissions as to, the value and/or condition of the Property.

(N) "Mortgage Insurance" means insurance protecting Lender against the nonpayment of, or default on, the Loan.

(O) "Periodic Payment" means the regularly scheduled amount due for (i) principal and interest under the Note, plus (ii) any amounts under Section 3 of this Security Instrument.

(P) "RESPA" means the Real Estate Settlement Procedures Act (12 U.S.C. Section 2601 et seq.) and its implementing regulation, Regulation X (24 C.F.R. Part 3500), as they might be amended from time to time, or any additional or successor legislation or regulation that governs the same subject matter. As used in this Security Instrument, "RESPA" refers to all requirements and restrictions that are imposed in regard to a "federally related mortgage loan" even if the Loan does not qualify as a "federally related mortgage loan" under RESPA.

(Q) "Successor in Interest of Borrower" means any party that has taken title to the Property, whether or not that party has assumed Borrower's obligations under the Note and/or this Security Instrument.

**TRANSFER OF RIGHTS IN THE PROPERTY**

This Security Instrument secures to Lender: (i) the repayment of the Loan, and all renewals, extensions and modifications of the Note; and (ii) the performance of Borrower's covenants and agreements under this Security Instrument and the Note. For this purpose, Borrower does hereby mortgage, grant and convey to MERS (solely as nominee for Lender and Lender's successors and assigns) and to the successors and assigns of MERS, the following described property located in the

COUNTY of PALM BEACH :  
[Type of Recording Jurisdiction] [Name of Recording Jurisdiction]

SEE EXHIBIT "A" ATTACHED HERETO AND MADE A PART HEREOF.

*THIS INSTRUMENT IS FILED IN THE PUBLIC RECORDS OF THE COUNTY OF DADE, FLORIDA.*

DOC ID #: 00013884537607006

Parcel ID Number: 8671 THORNBROOK TERRACE POINT, Boynton Beach  
[Street/City]

Florida 33437-4882 ("Property Address"):  
[Zip Code]

TOGETHER WITH all the improvements now or hereafter erected on the property, and all easements, appurtenances, and fixtures now or hereafter a part of the property. All replacements and additions shall also be covered by this Security Instrument. All of the foregoing is referred to in this Security Instrument as the "Property." Borrower understands and agrees that MERS holds only legal title to the interests granted by Borrower in this Security Instrument, but, if necessary to comply with law or custom, MERS (as nominee for Lender and Lender's successors and assigns) has the right to exercise any or all of those interests, including, but not limited to, the right to foreclose and sell the Property; and to take any action required of Lender including, but not limited to, releasing and canceling this Security Instrument.

BORROWER COVENANTS that Borrower is lawfully seized of the estate hereby conveyed and has the right to mortgage, grant and convey the Property and that the Property is unencumbered, except for encumbrances of record. Borrower warrants and will defend generally the title to the Property against all claims and demands, subject to any encumbrances of record.

THIS SECURITY INSTRUMENT combines uniform covenants for national use and non-uniform covenants with limited variations by jurisdiction to constitute a uniform security instrument covering real property.

UNIFORM COVENANTS. Borrower and Lender covenant and agree as follows:

1. **Payment of Principal, Interest, Escrow Items, Prepayment Charges, and Late Charges.** Borrower shall pay when due the principal of, and interest on, the debt evidenced by the Note and any prepayment charges and late charges due under the Note. Borrower shall also pay funds for Escrow Items pursuant to Section 3. Payments due under the Note and this Security Instrument shall be made in U.S. currency. However, if any check or other instrument received by Lender as payment under the Note or this Security Instrument is returned to Lender unpaid, Lender may require that any or all subsequent payments due under the Note and this Security Instrument be made in one or more of the following forms, as selected by Lender: (a) cash; (b) money order; (c) certified check, bank check, treasurer's check or cashier's check, provided any such check is drawn upon an institution whose deposits are insured by a federal agency, instrumentality, or entity; or (d) Electronic Funds Transfer.

Payments are deemed received by Lender when received at the location designated in the Note or at such other location as may be designated by Lender in accordance with the notice provisions in Section 15. Lender may return any payment or partial payment if the payment or partial payments are insufficient to bring the Loan current. Lender may accept any payment or partial payment insufficient to bring the Loan current, without waiver of any rights hereunder or prejudice to its rights to refuse such payment or partial payments in the future, but Lender is not obligated to apply such payments at the time such payments are accepted. If each Periodic Payment is applied as of its scheduled due date, then Lender need not pay interest on unapplied funds. Lender may hold such unapplied funds until Borrower makes payment to bring the Loan current. If Borrower does not do so within a reasonable period of time, Lender shall either apply such funds or return them to Borrower. If not applied earlier, such funds will be applied to the outstanding principal balance under the Note immediately prior to foreclosure. No offset or claim which Borrower might have now or in the future against Lender shall relieve Borrower from making payments due under the Note and this Security Instrument or performing the covenants and agreements secured by this Security Instrument.

2. **Application of Payments or Proceeds.** Except as otherwise described in this Section 2, all payments accepted and applied by Lender shall be applied in the following order of priority: (a) interest due under the Note; (b) principal due under the Note; (c) amounts due under Section 3. Such payments shall be applied to each Periodic Payment in the order in which it became due. Any remaining amounts shall be applied first to late charges, second to any other amounts due under this Security Instrument, and then to reduce the principal balance of the Note.

If Lender receives a payment from Borrower for a delinquent Periodic Payment which includes a sufficient amount to pay any late charge due, the payment may be applied to the delinquent payment and the late charge. If more than one Periodic Payment is outstanding, Lender may apply any payment received from Borrower to the repayment of the Periodic Payments if, and to the extent that, each payment can be paid in full. To the extent that any excess exists after the payment is applied to the full payment of one or more Periodic Payments, such excess may be applied to any late charges due. Voluntary prepayments shall be applied first to any prepayment charges and then as described in the Note.

THIS

DOC ID #: 00013884537607006

Any application of payments, insurance proceeds, or Miscellaneous Proceeds to principal due under the Note shall not extend or postpone the due date, or change the amount, of the Periodic Payments.

3. Funds for Escrow Items. Borrower shall pay to Lender on the day Periodic Payments are due under the Note, until the Note is paid in full, a sum (the "Funds") to provide for payment of amounts due for: (a) taxes and assessments and other items which can attain priority over this Security Instrument as a lien or encumbrance on the Property; (b) leasehold payments or ground rents on the Property, if any; (c) premiums for any and all insurance required by Lender under Section 5; and (d) Mortgage Insurance premiums, if any, or any sums payable by Borrower to Lender in lieu of the payment of Mortgage Insurance premiums in accordance with the provisions of Section 10. These items are called "Escrow Items." At origination or at any time during the term of the Loan, Lender may require that Community Association Dues, Fees, and Assessments, if any, be escrowed by Borrower, and such dues, fees and assessments shall be an Escrow Item. Borrower shall promptly furnish to Lender all notices of amounts to be paid under this Section. Borrower shall pay Lender the Funds for Escrow Items unless Lender waives Borrower's obligation to pay the Funds for any or all Escrow Items. Lender may waive Borrower's obligation to pay to Lender Funds for any or all Escrow Items at any time. Any such waiver may only be in writing. In the event of such waiver, Borrower shall pay directly, when and where payable, the amounts due for any Escrow Items for which payment of Funds has been waived by Lender and, if Lender requires, shall furnish to Lender receipts evidencing such payment within such time period as Lender may require. Borrower's obligation to make such payments and to provide receipts shall for all purposes be deemed to be a covenant and agreement contained in this Security Instrument, as the phrase "covenant and agreement" is used in Section 9. If Borrower is obligated to pay Escrow Items directly, pursuant to a waiver, and Borrower fails to pay the amount due for an Escrow Item, Lender may exercise its rights under Section 9 and pay such amount and Borrower shall then be obligated under Section 9 to repay to Lender any such amount. Lender may revoke the waiver as to any or all Escrow Items at any time by a notice given in accordance with Section 15 and, upon such revocation, Borrower shall pay to Lender all Funds, and in such amounts, that are then required under this Section 3.

Lender may, at any time, collect and hold Funds in an amount (a) sufficient to permit Lender to apply the Funds at the time specified under RESPA, and (b) not to exceed the maximum amount a lender can require under RESPA. Lender shall estimate the amount of Funds due on the basis of current data and reasonable estimates of expenditures of future Escrow Items or otherwise in accordance with Applicable Law.

The Funds shall be held in an institution whose deposits are insured by a federal agency, instrumentality, or entity (including Lender, if Lender is an institution whose deposits are so insured) or in any Federal Home Loan Bank. Lender shall apply the Funds to pay the Escrow Items no later than the time specified under RESPA. Lender shall not charge Borrower for holding and applying the Funds, annually analyzing the escrow account, or verifying the Escrow Items, unless Lender pays Borrower interest on the Funds and Applicable Law permits Lender to make such a charge. Unless an agreement is made in writing or Applicable Law requires interest to be paid on the Funds, Lender shall not be required to pay Borrower any interest or earnings on the Funds. Borrower and Lender can agree in writing, however, that interest shall be paid on the Funds. Lender shall give to Borrower, without charge, an annual accounting of the Funds as required by RESPA.

If there is a surplus of Funds held in escrow, as defined under RESPA, Lender shall account to Borrower for the excess funds in accordance with RESPA. If there is a shortage of Funds held in escrow, as defined under RESPA, Lender shall notify Borrower as required by RESPA, and Borrower shall pay to Lender the amount necessary to make up the shortage in accordance with RESPA, but in no more than 12 monthly payments. If there is a deficiency of Funds held in escrow, as defined under RESPA, Lender shall notify Borrower as required by RESPA, and Borrower shall pay to Lender the amount necessary to make up the deficiency in accordance with RESPA, but in no more than 12 monthly payments.

Upon payment in full of all sums secured by this Security Instrument, Lender shall promptly refund to Borrower any Funds held by Lender.

4. Charges; Liens. Borrower shall pay all taxes, assessments, charges, fines, and impositions attributable to the Property which can attain priority over this Security Instrument, leasehold payments or ground rents on the Property, if any, and Community Association Dues, Fees, and Assessments, if any. To the extent that these items are Escrow Items, Borrower shall pay them in the manner provided in Section 3.

Borrower shall promptly discharge any lien which has priority over this Security Instrument unless Borrower: (a) agrees in writing to the payment of the obligation secured by the lien in a manner acceptable to Lender, but only so long as Borrower is performing such agreement; (b) contests the lien in good faith by, or defends against enforcement of the lien in, legal proceedings which in Lender's opinion operate to prevent the enforcement of the lien while those proceedings are pending, but only until such proceedings are concluded; or (c) secures from the holder of the lien an agreement satisfactory to Lender subordinating the lien to this Security Instrument. If Lender determines that any part of the Property is subject to a lien which can attain priority over this Security Instrument, Lender may give Borrower a notice identifying the lien. Within 10 days of the date on which that notice is given, Borrower shall satisfy the lien or take one or more of the actions set forth above in this Section 4.

THIS

DOC ID #: 00013884537607006

Lender may require Borrower to pay a one-time charge for a real estate tax verification and/or reporting service used by Lender in connection with this Loan.

5. **Property Insurance.** Borrower shall keep the improvements now existing or hereafter erected on the Property insured against loss by fire, hazards included within the term "extended coverage," and any other hazards including, but not limited to, earthquakes and floods, for which Lender requires insurance. This insurance shall be maintained in the amounts (including deductible levels) and for the periods that Lender requires. What Lender requires pursuant to the preceding sentences can change during the term of the Loan. The insurance carrier providing the insurance shall be chosen by Borrower subject to Lender's right to disapprove Borrower's choice, which right shall not be exercised unreasonably. Lender may require Borrower to pay, in connection with this Loan, either: (a) a one-time charge for flood zone determination, certification and tracking services; or (b) a one-time charge for flood zone determination and certification services and subsequent charges each time remappings or similar changes occur which reasonably might affect such determination or certification. Borrower shall also be responsible for the payment of any fees imposed by the Federal Emergency Management Agency in connection with the review of any flood zone determination resulting from an objection by Borrower.

If Borrower fails to maintain any of the coverages described above, Lender may obtain insurance coverage, at Lender's option and Borrower's expense. Lender is under no obligation to purchase any particular type or amount of coverage. Therefore, such coverage shall cover Lender, but might or might not protect Borrower, Borrower's equity in the Property, or the contents of the Property, against any risk, hazard or liability and might provide greater or lesser coverage than was previously in effect. Borrower acknowledges that the cost of the insurance coverage so obtained might significantly exceed the cost of insurance that Borrower could have obtained. Any amounts disbursed by Lender under this Section 5 shall become additional debt of Borrower secured by this Security Instrument. These amounts shall bear interest at the Note rate from the date of disbursement and shall be payable, with such interest, upon notice from Lender to Borrower requesting payment.

All insurance policies required by Lender and renewals of such policies shall be subject to Lender's right to disapprove such policies, shall include a standard mortgage clause, and shall name Lender as mortgagee and/or as an additional loss payee. Lender shall have the right to hold the policies and renewal certificates. If Lender requires, Borrower shall promptly give to Lender all receipts of paid premiums and renewal notices. If Borrower obtains any form of insurance coverage, not otherwise required by Lender, for damage to, or destruction of, the Property, such policy shall include a standard mortgage clause and shall name Lender as mortgagee and/or as an additional loss payee.

In the event of loss, Borrower shall give prompt notice to the insurance carrier and Lender. Lender may make proof of loss if not made promptly by Borrower. Unless Lender and Borrower otherwise agree in writing, any insurance proceeds, whether or not the underlying insurance was required by Lender, shall be applied to restoration or repair of the Property, if the restoration or repair is economically feasible and Lender's security is not lessened. During such repair and restoration period, Lender shall have the right to hold such insurance proceeds until Lender has had an opportunity to inspect such Property to ensure the work has been completed to Lender's satisfaction, provided that such inspection shall be undertaken promptly. Lender may disburse proceeds for the repairs and restoration in a single payment or in a series of progress payments as the work is completed. Unless an agreement is made in writing or Applicable Law requires interest to be paid on such insurance proceeds, Lender shall not be required to pay Borrower any interest or earnings on such proceeds. Fees for public adjusters, or other third parties, retained by Borrower shall not be paid out of the insurance proceeds and shall be the sole obligation of Borrower. If the restoration or repair is not economically feasible or Lender's security would be lessened, the insurance proceeds shall be applied to the sums secured by this Security Instrument, whether or not then due, with the excess, if any, paid to Borrower. Such insurance proceeds shall be applied in the order provided for in Section 2.

If Borrower abandons the Property, Lender may file, negotiate and settle any available insurance claim and related matters. If Borrower does not respond within 30 days to a notice from Lender that the insurance carrier has offered to settle a claim, then Lender may negotiate and settle the claim. The 30-day period will begin when the notice is given. In either event, or if Lender acquires the Property under Section 22 or otherwise, Borrower hereby assigns to Lender (a) Borrower's rights to any insurance proceeds in an amount not to exceed the amounts unpaid under the Note or this Security Instrument, and (b) any other of Borrower's rights (other than the right to any refund of unearned premiums paid by Borrower) under all insurance policies covering the Property, insofar as such rights are applicable to the coverage of the Property. Lender may use the insurance proceeds either to repair or restore the Property or to pay amounts unpaid under the Note or this Security Instrument, whether or not then due.

THIS IS A COPY OF THE ORIGINAL DOCUMENT.

DOC ID #: 00013884537607006

**6. Occupancy.** Borrower shall occupy, establish, and use the Property as Borrower's principal residence within 60 days after the execution of this Security Instrument and shall continue to occupy the Property as Borrower's principal residence for at least one year after the date of occupancy, unless Lender otherwise agrees in writing, which consent shall not be unreasonably withheld, or unless extenuating circumstances exist which are beyond Borrower's control.

**7. Preservation, Maintenance and Protection of the Property; Inspections.** Borrower shall not destroy, damage or impair the Property, allow the Property to deteriorate or commit waste on the Property. Whether or not Borrower is residing in the Property, Borrower shall maintain the Property in order to prevent the Property from deteriorating or decreasing in value due to its condition. Unless it is determined pursuant to Section 5 that repair or restoration is not economically feasible, Borrower shall promptly repair the Property if damaged to avoid further deterioration or damage. If insurance or condemnation proceeds are paid in connection with damage to, or the taking of, the Property, Borrower shall be responsible for repairing or restoring the Property only if Lender has released proceeds for such purposes. Lender may disburse proceeds for the repairs and restoration in a single payment or in a series of progress payments as the work is completed. If the insurance or condemnation proceeds are not sufficient to repair or restore the Property, Borrower is not relieved of Borrower's obligation for the completion of such repair or restoration.

Lender or its agent may make reasonable entries upon and inspections of the Property. If it has reasonable cause, Lender may inspect the interior of the improvements on the Property. Lender shall give Borrower notice at the time of or prior to such an interior inspection specifying such reasonable cause.

**8. Borrower's Loan Application.** Borrower shall be in default if, during the Loan application process, Borrower or any persons or entities acting at the direction of Borrower or with Borrower's knowledge or consent gave materially false, misleading, or inaccurate information or statements to Lender (or failed to provide Lender with material information) in connection with the Loan. Material representations include, but are not limited to, representations concerning Borrower's occupancy of the Property as Borrower's principal residence.

**9. Protection of Lender's Interest in the Property and Rights Under this Security Instrument.** If (a) Borrower fails to perform the covenants and agreements contained in this Security Instrument, (b) there is a legal proceeding that might significantly affect Lender's interest in the Property and/or rights under this Security Instrument (such as a proceeding in bankruptcy, probate, for condemnation or forfeiture, for enforcement of a lien which may attain priority over this Security Instrument or to enforce laws or regulations), or (c) Borrower has abandoned the Property, then Lender may do and pay for whatever is reasonable or appropriate to protect Lender's interest in the Property and rights under this Security Instrument, including protecting and/or assessing the value of the Property, and securing and/or repairing the Property. Lender's actions can include, but are not limited to: (a) paying any sums secured by a lien which has priority over this Security Instrument; (b) appearing in court; and (c) paying reasonable attorneys' fees to protect its interest in the Property and/or rights under this Security Instrument, including its secured position in a bankruptcy proceeding. Securing the Property includes, but is not limited to, entering the Property to make repairs, change locks, replace or board up doors and windows, drain water from pipes, eliminate building or other code violations or dangerous conditions, and have utilities turned on or off. Although Lender may take action under this Section 9, Lender does not have to do so and is not under any duty or obligation to do so. It is agreed that Lender incurs no liability for not taking any or all actions authorized under this Section 9.

Any amounts disbursed by Lender under this Section 9 shall become additional debt of Borrower secured by this Security Instrument. These amounts shall bear interest at the Note rate from the date of disbursement and shall be payable, with such interest, upon notice from Lender to Borrower requesting payment.

If this Security Instrument is on a leasehold, Borrower shall comply with all the provisions of the lease. If Borrower acquires fee title to the Property, the leasehold and the fee title shall not merge unless Lender agrees to the merger in writing.

**10. Mortgage Insurance.** If Lender required Mortgage Insurance as a condition of making the Loan, Borrower shall pay the premiums required to maintain the Mortgage Insurance in effect. If, for any reason, the Mortgage Insurance coverage required by Lender ceases to be available from the mortgage insurer that previously provided such insurance and Borrower was required to make separately designated payments toward the premiums for Mortgage Insurance, Borrower shall pay the premiums required to obtain coverage substantially equivalent to the Mortgage Insurance previously in effect, at a cost substantially equivalent to the cost to Borrower of the Mortgage Insurance previously in effect, from an alternate mortgage insurer selected by Lender. If substantially equivalent Mortgage Insurance coverage is not available, Borrower shall continue to pay to Lender the amount of the separately designated payments that were due when the insurance coverage ceased to be in effect. Lender will accept, use and retain these payments as a non-refundable loss reserve in lieu of Mortgage Insurance. Such loss reserve shall be non-refundable, notwithstanding the fact that the Loan is ultimately paid in full, and Lender shall not be required to pay Borrower any interest or earnings on such loss reserve. Lender can no longer require loss reserve payments if Mortgage Insurance coverage (in the

This

DOC ID #: 00013884537607006

amount and for the period that Lender requires) provided by an insurer selected by Lender again becomes available, is obtained, and Lender requires separately designated payments toward the premiums for Mortgage Insurance. If Lender required Mortgage Insurance as a condition of making the Loan and Borrower was required to make separately designated payments toward the premiums for Mortgage Insurance, Borrower shall pay the premiums required to maintain Mortgage Insurance in effect, or to provide a non-refundable loss reserve, until Lender's requirement for Mortgage Insurance ends in accordance with any written agreement between Borrower and Lender providing for such termination or until termination is required by Applicable Law. Nothing in this Section 10 affects Borrower's obligation to pay interest at the rate provided in the Note.

Mortgage Insurance reimburses Lender (or any entity that purchases the Note) for certain losses it may incur if Borrower does not repay the Loan as agreed. Borrower is not a party to the Mortgage Insurance.

Mortgage insurers evaluate their total risk on all such insurance in force from time to time, and may enter into agreements with other parties that share or modify their risk, or reduce losses. These agreements are on terms and conditions that are satisfactory to the mortgage insurer and the other party (or parties) to these agreements. These agreements may require the mortgage insurer to make payments using any source of funds that the mortgage insurer may have available (which may include funds obtained from Mortgage Insurance premiums).

As a result of these agreements, Lender, any purchaser of the Note, another insurer, any reinsurer, any other entity, or any affiliate of any of the foregoing, may receive (directly or indirectly) amounts that derive from (or might be characterized as) a portion of Borrower's payments for Mortgage Insurance, in exchange for sharing or modifying the mortgage insurer's risk, or reducing losses. If such agreement provides that an affiliate of Lender takes a share of the insurer's risk in exchange for a share of the premiums paid to the insurer, the arrangement is often termed "captive reinsurance." Further:

(a) Any such agreements will not affect the amounts that Borrower has agreed to pay for Mortgage Insurance, or any other terms of the Loan. Such agreements will not increase the amount Borrower will owe for Mortgage Insurance, and they will not entitle Borrower to any refund.

(b) Any such agreements will not affect the rights Borrower has - if any - with respect to the Mortgage Insurance under the Homeowners Protection Act of 1998 or any other law. These rights may include the right to receive certain disclosures, to request and obtain cancellation of the Mortgage Insurance, to have the Mortgage Insurance terminated automatically, and/or to receive a refund of any Mortgage Insurance premiums that were unearned at the time of such cancellation or termination.

11. Assignment of Miscellaneous Proceeds; Forfeiture. All Miscellaneous Proceeds are hereby assigned to and shall be paid to Lender.

If the Property is damaged, such Miscellaneous Proceeds shall be applied to restoration or repair of the Property, if the restoration or repair is economically feasible and Lender's security is not lessened. During such repair and restoration period, Lender shall have the right to hold such Miscellaneous Proceeds until Lender has had an opportunity to inspect such Property to ensure the work has been completed to Lender's satisfaction, provided that such inspection shall be undertaken promptly. Lender may pay for the repairs and restoration in a single disbursement or in a series of progress payments as the work is completed. Unless an agreement is made in writing or Applicable Law requires interest to be paid on such Miscellaneous Proceeds, Lender shall not be required to pay Borrower any interest or earnings on such Miscellaneous Proceeds. If the restoration or repair is not economically feasible or Lender's security would be lessened, the Miscellaneous Proceeds shall be applied to the sums secured by this Security Instrument, whether or not then due, with the excess, if any, paid to Borrower. Such Miscellaneous Proceeds shall be applied in the order provided for in Section 2.

In the event of a total taking, destruction, or loss in value of the Property, the Miscellaneous Proceeds shall be applied to the sums secured by this Security Instrument, whether or not then due, with the excess, if any, paid to Borrower.

In the event of a partial taking, destruction, or loss in value of the Property in which the fair market value of the Property immediately before the partial taking, destruction, or loss in value is equal to or greater than the amount of the sums secured by this Security Instrument immediately before the partial taking, destruction, or loss in value, unless Borrower and Lender otherwise agree in writing, the sums secured by this Security Instrument shall be reduced by the amount of the Miscellaneous Proceeds multiplied by the following fraction: (a) the total amount of the sums secured immediately before the partial taking, destruction, or loss in value divided by (b) the fair market value of the Property immediately before the partial taking, destruction, or loss in value. Any balance shall be paid to Borrower.

In the event of a partial taking, destruction, or loss in value of the Property in which the fair market value of the Property immediately before the partial taking, destruction, or loss in value is less than the amount of the sums secured immediately before the partial taking, destruction, or loss in value, unless Borrower and Lender otherwise agree in writing, the Miscellaneous Proceeds shall be applied to the sums secured by this Security Instrument whether or not the sums are then due.

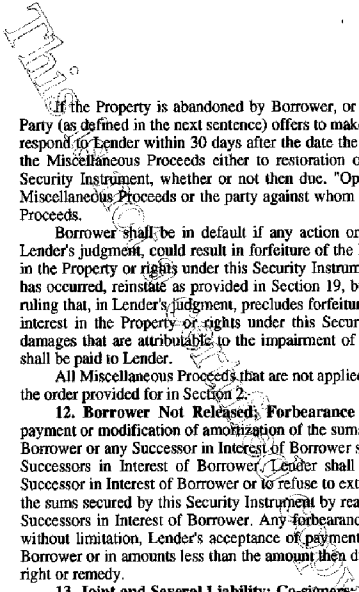

DOC ID #: 00013884537607006

If the Property is abandoned by Borrower, or if, after notice by Lender to Borrower that the Opposing Party (as defined in the next sentence) offers to make an award to settle a claim for damages, Borrower fails to respond to Lender within 30 days after the date the notice is given, Lender is authorized to collect and apply the Miscellaneous Proceeds either to restoration or repair of the Property or to the sums secured by this Security Instrument, whether or not then due. "Opposing Party" means the third party that owes Borrower Miscellaneous Proceeds or the party against whom Borrower has a right of action in regard to Miscellaneous Proceeds.

Borrower shall be in default if any action or proceeding, whether civil or criminal, is begun that, in Lender's judgment, could result in forfeiture of the Property or other material impairment of Lender's interest in the Property or rights under this Security Instrument. Borrower can cure such a default and, if acceleration has occurred, reinstated as provided in Section 19, by causing the action or proceeding to be dismissed with a ruling that, in Lender's judgment, precludes forfeiture of the Property or other material impairment of Lender's interest in the Property or rights under this Security Instrument. The proceeds of any award or claim for damages that are attributable to the impairment of Lender's interest in the Property are hereby assigned and shall be paid to Lender.

All Miscellaneous Proceeds that are not applied to restoration or repair of the Property shall be applied in the order provided for in Section 2.

**12. Borrower Not Released; Forbearance By Lender Not a Waiver.** Extension of the time for payment or modification of amortization of the sums secured by this Security Instrument granted by Lender to Borrower or any Successor in Interest of Borrower shall not operate to release the liability of Borrower or any Successors in Interest of Borrower. Lender shall not be required to commence proceedings against any Successor in Interest of Borrower or to refuse to extend time for payment or otherwise modify amortization of the sums secured by this Security Instrument by reason of any demand made by the original Borrower or any Successors in Interest of Borrower. Any forbearance by Lender in exercising any right or remedy including, without limitation, Lender's acceptance of payments from third persons, entities or Successors in Interest of Borrower or in amounts less than the amount then due, shall not be a waiver of or preclude the exercise of any right or remedy.

**13. Joint and Several Liability; Co-signers; Successors and Assigns Bound.** Borrower covenants and agrees that Borrower's obligations and liability shall be joint and several. However, any Borrower who co-signs this Security Instrument but does not execute the Note (a "co-signer"): (a) is co-signing this Security Instrument only to mortgage, grant and convey the co-signer's interest in the Property under the terms of this Security Instrument; (b) is not personally obligated to pay the sums secured by this Security Instrument; and (c) agrees that Lender and any other Borrower can agree to extend, modify, forbear or make any accommodations with regard to the terms of this Security Instrument or the Note without the co-signer's consent.

Subject to the provisions of Section 18, any Successor in Interest of Borrower who assumes Borrower's obligations under this Security Instrument in writing, and is approved by Lender, shall obtain all of Borrower's rights and benefits under this Security Instrument. Borrower shall not be released from Borrower's obligations and liability under this Security Instrument unless Lender agrees to such release in writing. The covenants and agreements of this Security Instrument shall bind (except as provided in Section 20) and benefit the successors and assigns of Lender.

**14. Loan Charges.** Lender may charge Borrower fees for services performed in connection with Borrower's default, for the purpose of protecting Lender's interest in the Property and rights under this Security Instrument, including, but not limited to, attorneys' fees, property inspection and valuation fees. In regard to any other fees, the absence of express authority in this Security Instrument to charge a specific fee to Borrower shall not be construed as a prohibition on the charging of such fee. Lender may not charge fees that are expressly prohibited by this Security Instrument or by Applicable Law.

If the Loan is subject to a law which sets maximum loan charges, and that law is finally interpreted so that the interest or other loan charges collected or to be collected in connection with the Loan exceed the permitted limits, then: (a) any such loan charge shall be reduced by the amount necessary to reduce the charge to the permitted limit; and (b) any sums already collected from Borrower which exceeded permitted limits will be refunded to Borrower. Lender may choose to make this refund by reducing the principal owed under the Note or by making a direct payment to Borrower. If a refund reduces principal, the reduction will be treated as a partial prepayment without any prepayment charge (whether or not a prepayment charge is provided for under the Note). Borrower's acceptance of any such refund made by direct payment to Borrower will constitute a waiver of any right of action Borrower might have arising out of such overcharge.

**15. Notices.** All notices given by Borrower or Lender in connection with this Security Instrument must be in writing. Any notice to Borrower in connection with this Security Instrument shall be deemed to have been given to Borrower when mailed by first class mail or when actually delivered to Borrower's notice address if sent by other means. Notice to any one Borrower shall constitute notice to all Borrowers unless Applicable Law expressly requires otherwise. The notice address shall be the Property Address unless



DOC ID #: 00013884537607006

Borrower has designated a substitute notice address by notice to Lender. Borrower shall promptly notify Lender of Borrower's change of address. If Lender specifies a procedure for reporting Borrower's change of address, then Borrower shall only report a change of address through that specified procedure. There may be only one designated notice address under this Security Instrument at any one time. Any notice to Lender shall be given by delivering it or by mailing it by first class mail to Lender's address stated herein unless Lender has designated another address by notice to Borrower. Any notice in connection with this Security Instrument shall not be deemed to have been given to Lender until actually received by Lender. If any notice required by this Security Instrument is also required under Applicable Law, the Applicable Law requirement will satisfy the corresponding requirement under this Security Instrument.

**16. Governing Law; Severability; Rules of Construction.** This Security Instrument shall be governed by federal law and the law of the jurisdiction in which the Property is located. All rights and obligations contained in this Security Instrument are subject to any requirements and limitations of Applicable Law. Applicable Law might explicitly or implicitly allow the parties to agree by contract or it might be silent, but such silence shall not be construed as a prohibition against agreement by contract. In the event that any provision or clause of this Security Instrument or the Note conflicts with Applicable Law, such conflict shall not affect other provisions of this Security Instrument or the Note which can be given effect without the conflicting provision.

As used in this Security Instrument: (a) words of the masculine gender shall mean and include corresponding neuter words or words of the feminine gender; (b) words in the singular shall mean and include the plural and vice versa; and (c) the word "may" gives sole discretion without any obligation to take any action.

**17. Borrower's Copy.** Borrower shall be given one copy of the Note and of this Security Instrument.

**18. Transfer of the Property or a Beneficial Interest in Borrower.** As used in this Section 18, "Interest in the Property" means any legal or beneficial interest in the Property, including, but not limited to, those beneficial interests transferred in a bond for deed, contract for deed, installment sales contract or escrow agreement, the intent of which is the transfer of title by Borrower at a future date to a purchaser.

If all or any part of the Property or any Interest in the Property is sold or transferred (or if Borrower is not a natural person and a beneficial interest in Borrower is sold or transferred) without Lender's prior written consent, Lender may require immediate payment in full of all sums secured by this Security Instrument. However, this option shall not be exercised by Lender if such exercise is prohibited by Applicable Law.

If Lender exercises this option, Lender shall give Borrower notice of acceleration. The notice shall provide a period of not less than 30 days from the date the notice is given in accordance with Section 15 within which Borrower must pay all sums secured by this Security Instrument. If Borrower fails to pay these sums prior to the expiration of this period, Lender may invoke any remedies permitted by this Security Instrument without further notice or demand on Borrower.

**19. Borrower's Right to Reinstate After Acceleration.** If Borrower meets certain conditions, Borrower shall have the right to have enforcement of this Security Instrument discontinued at any time prior to the earliest of: (a) five days before sale of the Property pursuant to any power of sale contained in this Security Instrument; (b) such other period as Applicable Law might specify for the termination of Borrower's right to reinstate; or (c) entry of a judgment enforcing this Security Instrument. Those conditions are that Borrower: (a) pays Lender all sums which then would be due under this Security Instrument and the Note as if no acceleration had occurred; (b) cures any default of any other covenants or agreements; (c) pays all expenses incurred in enforcing this Security Instrument, including, but not limited to, reasonable attorneys' fees, property inspection and valuation fees, and other fees incurred for the purpose of protecting Lender's interest in the Property and rights under this Security Instrument; and (d) takes such action as Lender may reasonably require to assure that Lender's interest in the Property and rights under this Security Instrument, and Borrower's obligation to pay the sums secured by this Security Instrument, shall continue unchanged. Lender may require that Borrower pay such reinstatement sums and expenses in one or more of the following forms, as selected by Lender: (a) cash; (b) money order; (c) certified check, bank check, treasurer's check or cashier's check, provided any such check is drawn upon an institution whose deposits are insured by a federal agency, instrumentality or entity; or (d) Electronic Funds Transfer. Upon reinstatement by Borrower, this Security Instrument and obligations secured hereby shall remain fully effective as if no acceleration had occurred. However, this right to reinstate shall not apply in the case of acceleration under Section 18.

**20. Sale of Note; Change of Loan Servicer; Notice of Grievance.** The Note or a partial interest in the Note (together with this Security Instrument) can be sold one or more times without prior notice to Borrower. A sale might result in a change in the entity (known as the "Loan Servicer") that collects Periodic Payments due under the Note and this Security Instrument and performs other mortgage loan servicing obligations under the Note, this Security Instrument, and Applicable Law. There also might be one or more changes of the Loan Servicer unrelated to a sale of the Note. If there is a change of the Loan Servicer, Borrower will be given written notice of the change which will state the name and address of the new Loan Servicer, the address to

This

DOC ID #: 00013884537607006

which payments should be made and any other information RESPA requires in connection with a notice of transfer of servicing. If the Note is sold and thereafter the Loan is serviced by a Loan Servicer other than the purchaser of the Note, the mortgage loan servicing obligations to Borrower will remain with the Loan Servicer or be transferred to a successor Loan Servicer and are not assumed by the Note purchaser unless otherwise provided by the Note purchaser.

Neither Borrower nor Lender may commence, join, or be joined to any judicial action (as either an individual litigant or the member of a class) that arises from the other party's actions pursuant to this Security Instrument or that alleges that the other party has breached any provision of, or any duty owed by reason of, this Security Instrument, until such Borrower or Lender has notified the other party (with such notice given in compliance with the requirements of Section 15) of such alleged breach and afforded the other party hereto a reasonable period after the giving of such notice to take corrective action. If Applicable Law provides a time period which must elapse before certain action can be taken, that time period will be deemed to be reasonable for purposes of this paragraph. The notice of acceleration and opportunity to cure given to Borrower pursuant to Section 22 and the notice of acceleration given to Borrower pursuant to Section 18 shall be deemed to satisfy the notice and opportunity to take corrective action provisions of this Section 20.

21. **Hazardous Substances.** As used in this Section 21: (a) "Hazardous Substances" are those substances defined as toxic or hazardous substances, pollutants, or wastes by Environmental Law and the following substances: gasoline, kerosene, other flammable or toxic petroleum products, toxic pesticides and herbicides, volatile solvents, materials containing asbestos or formaldehyde, and radioactive materials; (b) "Environmental Law" means federal laws and laws of the jurisdiction where the Property is located that relate to health, safety or environmental protection; (c) "Environmental Cleanup" includes any response action, remedial action, or removal action, as defined in Environmental Law; and (d) an "Environmental Condition" means a condition that can cause, contribute to, or otherwise trigger an Environmental Cleanup.

Borrower shall not cause or permit the presence, use, disposal, storage, or release of any Hazardous Substances, or threaten to release any Hazardous Substances, on or in the Property. Borrower shall not do, nor allow anyone else to do, anything affecting the Property (a) that is in violation of any Environmental Law, (b) which creates an Environmental Condition, or (c) which, due to the presence, use, or release of a Hazardous Substance, creates a condition that adversely affects the value of the Property. The preceding two sentences shall not apply to the presence, use, or storage on the Property of small quantities of Hazardous Substances that are generally recognized to be appropriate to normal residential uses and to maintenance of the Property (including, but not limited to, hazardous substances in consumer products).

Borrower shall promptly give Lender written notice of (a) any investigation, claim, demand, lawsuit or other action by any governmental or regulatory agency or private party involving the Property and any Hazardous Substance or Environmental Law of which Borrower has actual knowledge, (b) any Environmental Condition, including but not limited to, any spilling, leaking, discharge, release or threat of release of any Hazardous Substance, and (c) any condition caused by the presence, use or release of a Hazardous Substance which adversely affects the value of the Property. If Borrower learns, or is notified by any governmental or regulatory authority, or any private party, that any removal or other remediation of any Hazardous Substance affecting the Property is necessary, Borrower shall promptly take all necessary remedial actions in accordance with Environmental Law. Nothing herein shall create any obligation on Lender for an Environmental Cleanup.

NON-UNIFORM COVENANTS. Borrower and Lender further covenant and agree as follows:

22. **Acceleration; Remedies.** Lender shall give notice to Borrower prior to acceleration following Borrower's breach of any covenant or agreement in this Security Instrument (but not prior to acceleration under Section 18 unless Applicable Law provides otherwise). The notice shall specify: (a) the default; (b) the action required to cure the default; (c) a date, not less than 30 days from the date the notice is given to Borrower, by which the default must be cured; and (d) that failure to cure the default on or before the date specified in the notice may result in acceleration of the sums secured by this Security Instrument, foreclosure by judicial proceeding and sale of the Property. The notice shall further inform Borrower of the right to reinstate after acceleration and the right to assert in the foreclosure proceeding the non-existence of a default or any other defense of Borrower to acceleration and foreclosure. If the default is not cured on or before the date specified in the notice, Lender at its option may require immediate payment in full of all sums secured by this Security Instrument without further demand and may foreclose this Security Instrument by judicial proceeding. Lender shall be entitled to collect all expenses incurred in pursuing the remedies provided in this Section 22, including, but not limited to, reasonable attorneys' fees and costs of title evidence.

23. **Release.** Upon payment of all sums secured by this Security Instrument, Lender shall release this Security Instrument. Borrower shall pay any recordation costs. Lender may charge Borrower a fee for releasing this Security Instrument, but only if the fee is paid to a third party for services rendered and the charging of the fee is permitted under Applicable Law.

This document is a certified copy

DOC ID #: 00013884537607006

24. Attorneys' Fees. As used in this Security Instrument and the Note, attorneys' fees shall include those awarded by an appellate court and any attorneys' fees incurred in a bankruptcy proceeding.

25. Jury Trial Waiver. The Borrower hereby waives any right to a trial by jury in any action, proceeding, claim, or counterclaim, whether in contract or tort, at law or in equity, arising out of or in any way related to this Security Instrument or the Note.

BY SIGNING BELOW, Borrower accepts and agrees to the terms and covenants contained in this Security Instrument and in any Rider executed by Borrower and recorded with it.

Signed, sealed and delivered in the presence of:

Handwritten signatures and printed names of Jean B. JEANGLAUE and Gertrude Arthur JEANGLAUE, both borrowers, with their address at 11 HEMMING DR, STAFFORD, VA 22554.

Notary acknowledgment section: STATE OF VA, County ss: Fairfax, August 2006, by JEAN B JEANGLAUE AND GERTRUDE ARTHUR JEANGLAUE, who is personally known to me or who has produced driver's licenses as identification.

Notary Public signature and date 3/31/07

Prepared by: YVETTE ZAPATA

**GL FINANCIAL SERVICES, LLC.**

DATE: 08/03/2006

CASE #:

DOC ID #: 00013884537607006

BORROWER: JEAN B. JEANLAUDE

PROPERTY ADDRESS: 8671 THORNBROOK TERRACE POINT  
Boynton Beach, FL 33437-4882

210 N. UNIVERSITY DR STE 601  
CORAL SPRINGS, FL 33071  
Phone: (954) 825-4300  
Brk Fax No.: (954) 825-4320

**LEGAL DESCRIPTION EXHIBIT A**

Lot 117, CANYON ISLES PLAT ONE, according to the plat thereof, as recorded in Plat Book 105 at Page 1 of the Public Records of Palm Beach County, Florida

FHAVA/CONV  
Legal Description Exhibit A  
2C404-XX (04/03)d



This is not a certified copy

**PLANNED UNIT DEVELOPMENT RIDER**

After Recording Return To:  
COUNTRYWIDE HOME LOANS, INC.  
MS SV-79 DOCUMENT PROCESSING  
P.O.Box 10423  
Van Nuys, CA 91410-0423

Prepared By:  
YVETTE ZAPATA  
GL FINANCIAL SERVICES, LLC.

210 N. UNIVERSITY DR STE 601  
CORAL SPRINGS, FL 33071

00013884537607006  
[Doc ID #]

THIS PLANNED UNIT DEVELOPMENT RIDER is made this **THIRD** day of **AUGUST**, 2006, and is incorporated into and shall be deemed to amend and supplement the Mortgage, Deed of Trust, or Security Deed (the "Security Instrument") of the same date, given by the undersigned (the "Borrower") to secure Borrower's Note to **GL FINANCIAL SERVICES, LLC.**

(the "Lender") of the same date and covering the Property described in the Security Instrument and located at:

8671 THORNBROOK TERRACE POINT  
Boynton Beach, FL 33437-4882  
[Property Address]

The Property includes, but is not limited to, a parcel of land improved with a dwelling, together with

MULTISTATE PUD RIDER - Single Family - Fannie Mae/Freddie Mac UNIFORM INSTRUMENT  
VMP-7R (0405) CHL (06/04)(d) Page 1 of 3 Initials **GAJ**  
VMP Mortgage Solutions, Inc. (800)521-7291 Form 3150 1/01



This Document Not a Contract

DOC ID #: 00013884537607006

other such parcels and certain common areas and facilities, as described in THE COVENANTS, CONDITIONS, AND RESTRICTIONS FILED OF RECORD THAT AFFECT THE PROPERTY

ORB 19820, PG 216

(the "Declaration"). The Property is a part of a planned unit development known as CANYON ISLES

[Name of Planned Unit Development]

(the "PUD"). The Property also includes Borrower's interest in the homeowners association or equivalent entity owning or managing the common areas and facilities of the PUD (the "Owners Association") and the uses, benefits and proceeds of Borrower's interest.

**PUD COVENANTS.** In addition to the covenants and agreements made in the Security Instrument, Borrower and Lender further covenant and agree as follows:

**A. PUD Obligations.** Borrower shall perform all of Borrower's obligations under the PUD's Constituent Documents. The "Constituent Documents" are the (i) Declaration; (ii) articles of incorporation, trust instrument or any equivalent document which creates the Owners Association; and (iii) any by-laws or other rules or regulations of the Owners Association. Borrower shall promptly pay, when due, all dues and assessments imposed pursuant to the Constituent Documents.

**B. Property Insurance.** So long as the Owners Association maintains, with a generally accepted insurance carrier, a "master" or "blanket" policy insuring the Property which is satisfactory to Lender and which provides insurance coverage in the amounts (including deductible levels), for the periods, and against loss by fire, hazards included within the term "extended coverage," and any other hazards, including, but not limited to, earthquakes and floods, for which Lender requires insurance, then: (i) Lender waives the provision in Section 3 for the Periodic Payment to Lender of the yearly premium installments for property insurance on the Property; and (ii) Borrower's obligation under Section 5 to maintain property insurance coverage on the Property is deemed satisfied to the extent that the required coverage is provided by the Owners Association policy.

What Lender requires as a condition of this waiver can change during the term of the loan.

Borrower shall give Lender prompt notice of any lapse in required property insurance coverage provided by the master or blanket policy.

In the event of a distribution of property insurance proceeds in lieu of restoration or repair following a loss to the Property, or to common areas and facilities of the PUD, any proceeds payable to Borrower are hereby assigned and shall be paid to Lender. Lender shall apply the proceeds to the sums secured by the Security Instrument, whether or not then due, with the excess, if any, paid to Borrower.

**C. Public Liability Insurance.** Borrower shall take such actions as may be reasonable to insure that the Owners Association maintains a public liability insurance policy acceptable in form, amount, and extent of coverage to Lender.

**D. Condemnation.** The proceeds of any award or claim for damages, direct or consequential, payable to Borrower in connection with any condemnation or other taking of all or any part of the Property or the common areas and facilities of the PUD, or for any conveyance in lieu of condemnation, are hereby assigned and shall be paid to Lender. Such proceeds shall be applied by Lender to the sums secured by the Security Instrument as provided in Section 11.

**E. Lender's Prior Consent.** Borrower shall not, except after notice to Lender and with Lender's prior written consent, either partition or subdivide the Property or consent to: (i) the abandonment or termination of the PUD, except for abandonment or termination required by law in the case of substantial destruction by fire or other casualty or in the case of a taking by condemnation or eminent domain; (ii) any amendment to any provision of the "Constituent Documents" if the provision is for the

WMPD -7R (0405) CHL (06/04)

Page 2 of 3

Initials: [Handwritten initials] Form 3150 1/01

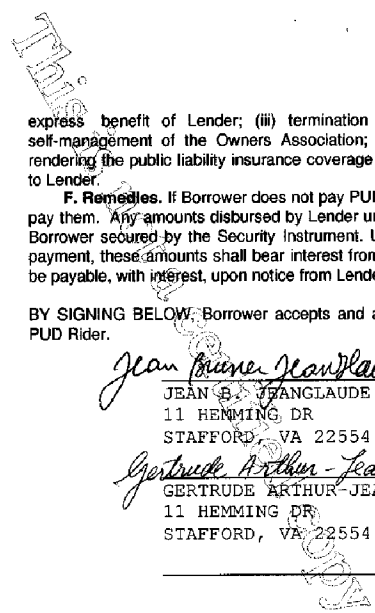

DOC ID #: 00013884537607006

express benefit of Lender; (iii) termination of professional management and assumption of self-management of the Owners Association; or (iv) any action which would have the effect of rendering the public liability insurance coverage maintained by the Owners Association unacceptable to Lender.

**F. Remedies.** If Borrower does not pay PUD dues and assessments when due, then Lender may pay them. Any amounts disbursed by Lender under this paragraph F shall become additional debt of Borrower secured by the Security Instrument. Unless Borrower and Lender agree to other terms of payment, these amounts shall bear interest from the date of disbursement at the Note rate and shall be payable, with interest, upon notice from Lender to Borrower requesting payment.

BY SIGNING BELOW, Borrower accepts and agrees to the terms and provisions contained in this PUD Rider.

*Jean Marie Jeanglaude* \_\_\_\_\_ (Seal)  
JEAN B. JEANGLAUE - Borrower

11 HEMMING DR  
STAFFORD, VA 22554

*Gertrude Arthur - Jeanglaude* \_\_\_\_\_ (Seal)  
GERTRUDE ARTHUR - JEANGLAUE - Borrower

11 HEMMING DR  
STAFFORD, VA 22554

\_\_\_\_\_  
- Borrower (Seal)

\_\_\_\_\_  
- Borrower (Seal)

This is not a certified copy

SECOND HOME RIDER

After Recording Return To:
COUNTRYWIDE HOME LOANS, INC.
MS SV-79 DOCUMENT PROCESSING
P.O.Box 10423
Van Nuys, CA 91410-0423

Prepared By:
YVETTE ZAPATA
GL FINANCIAL SERVICES, LLC.

210 N. UNIVERSITY DR STE 601
CORAL SPRINGS, FL 33071

00013884537607006
[Doc ID #]

THIS SECOND HOME RIDER is made this THIRD day of
AUGUST, 2006, and is incorporated into and shall be deemed to amend and supplement
the Mortgage, Deed of Trust, or Security Deed (the "Security Instrument") of the same date given by the
undersigned (the "Borrower" whether there are one or more persons undersigned) to secure Borrower's Note to
GL FINANCIAL SERVICES, LLC.

(the "Lender") of the same date and covering the Property described in the Security Instrument (the "Property"),
which is located at:

8671 THORNBROOK TERRACE POINT
Boynton Beach, FL 33437-4882
[Property Address]

MULTISTATE SECOND HOME RIDER - Single Family - Fannie Mae/Freddie Mac UNIFORM
INSTRUMENT Page 1 of 2
VMP-365R (0405) CHL (06/04)(d)
VMP Mortgage Solutions, Inc. (800)521-7291

Initials: [Signature]
Form 3890 1/01





This document contains information that is confidential and exempt from disclosure under the Freedom of Information Act.

DOC ID #: 00013884537607006

In addition to the covenants and agreements made in the Security Instrument, Borrower and Lender further covenant and agree that Sections 6 and 8 of the Security Instrument are deleted and are replaced by the following:

- 6. **Occupancy.** Borrower shall occupy, and shall only use, the Property as Borrower's second home. Borrower shall keep the Property available for Borrower's exclusive use and enjoyment at all times, and shall not subject the Property to any timesharing or other shared ownership arrangement or to any rental pool or agreement that requires Borrower either to rent the Property or give a management firm or any other person any control over the occupancy or use of the Property.
- 8. **Borrower's Loan Application.** Borrower shall be in default if, during the Loan application process, Borrower or any persons or entities acting at the direction of Borrower or with Borrower's knowledge or consent gave materially false, misleading, or inaccurate information or statements to Lender (or failed to provide Lender with material information) in connection with the Loan. Material representations include, but are not limited to, representations concerning Borrower's occupancy of the Property as Borrower's second home.

BY SIGNING BELOW, Borrower accepts and agrees to the terms and provisions contained in this Second Home Rider.

*Jean Bruner Jean Claude* \_\_\_\_\_ (Seal)  
- Borrower

JEAN B. JEANGLAUE  
11 HEMMING DR  
STAFFORD, VA 22554

*Gertrude Arthur Jeanglaude* \_\_\_\_\_ (Seal)  
- Borrower

GERTRUDE ARTHUR-JEANGLAUE  
11 HEMMING DR  
STAFFORD, VA 22554

\_\_\_\_\_ (Seal)  
- Borrower

\_\_\_\_\_ (Seal)  
- Borrower



3

After Recording Return To:  
 COUNTRYWIDE HOME LOANS, INC.  
 MS SV-79 DOCUMENT PROCESSING  
 P.O. Box 10423  
 Van Nuys, CA 91410-0423  
 This document was prepared by:  
 YVETTE ZAPATA  
 GL FINANCIAL SERVICES, LLC.

CFN 20060462329  
 OR BK 20706 PG 0344  
 RECORDED 08/08/2006 15:46:06  
 Palm Beach County, Florida  
 AMT 141,120.00  
 Deed Doc 494.20  
 Intang 282.24  
 Sharon R. Bock, CLERK & COMPTROLLER  
 Pgs 0344 - 354; (11pgs)

W/C 84

210 N. UNIVERSITY DR STE 601  
 CORAL SPRINGS, FL 33071

[Space Above This Line For Recording Data]

00013884536807006  
 [Doc ID #]

**MORTGAGE**  
 (Line of Credit)

MIN 1000157-0007101590-9

THIS MORTGAGE, dated AUGUST 03, 2006, is between  
 JEAN B JEANGLAUDE, AND GERTRUDE ARTHUR-JEANGLAUDE, HUSBAND AND WIFE

residing at  
 11 HEMMING DR

the person or persons signing as "Mortgagor(s)" below and hereinafter referred to as "we," "our," or "us" and MORTGAGE ELECTRONIC REGISTRATION SYSTEMS, INC., ("MERS") a Delaware corporation with an address of P.O. Box 2026, Flint, MI 48503-2026, tel. (888) 679-MERS acting solely as nominee for GL FINANCIAL SERVICES, LLC. ("Lender" or "you") and its successors and assigns. MERS is the "Mortgagee" under this Mortgage.

MORTGAGED PREMISES: In consideration of the loan hereinafter described, we hereby mortgage, grant and convey to MERS (solely as nominee for Lender and Lender's successors and assigns) and to the successors and assigns of MERS, the premises located at:

8671 THORNEROOK TERRACE POINT

Street

BOYNTON BEACH

PALM BEACH

Municipality

County

FL 33437 (the "Premises").

State ZIP

and further described as:

SEE EXHIBIT "A" ATTACHED HERETO AND MADE A PART HEREOF.

● MERS HELOC - FL MORTGAGE  
 2D993-FL (11/04)(c)

Page 1 of 5

INITIALS  
 MERE  
 GAJ



DOC ID #: 00013884536807006

The Premises includes all buildings and other improvements now or in the future on the Premises and all rights and interests which derive from our ownership, use or possession of the Premises and all appurtenances thereto.

WE UNDERSTAND and agree that MERS is a separate corporation acting solely as nominee for Lender and Lender's successors and assigns, and holds only legal title to the interests granted by us in this Mortgage, but, if necessary to comply with law or custom, MERS (as nominee for Lender and Lender's successors and assigns) has the right: to exercise any or all of those interests, including, but not limited to, the right to foreclose and sell the Property, and to take any action required of Lender including, but not limited to, releasing or canceling this Mortgage

LOAN: This Mortgage will secure Lender's loan to us in the principal amount of \$ 141,120.00 or so much thereof as may be advanced and readvanced from time to time to JEAN B. JEANGLAIDE GERTRUDE ARTHUR-JEANGLAIDE , and

the Borrower(s) under the Home Equity Credit Line Agreement And Disclosure Statement (the "Note") dated 08/03/2006 , plus interest and costs, late charges and all other charges related to the loan, all of which sums are repayable according to the Note. This Mortgage will also secure the performance of all of the promises and agreements made by us and each Borrower and Co-Signer in the Note, all of our promises and agreements in this Mortgage, any extensions, renewals, amendments, supplements and other modifications of the Note, and any amounts advanced by you under the terms of the section of this Mortgage entitled "Our Authority To You." Loans under the Note may be made, repaid and remade from time to time in accordance with the terms of the Note and subject to the Credit Limit set forth in the Note.

OWNERSHIP: We are the sole owner(s) of the Premises. We have the legal right to mortgage the Premises to you.

OUR IMPORTANT OBLIGATIONS:

(a) TAXES: We will pay all real estate taxes, assessments, water charges and sewer rents relating to the Premises when they become due. We will not claim any credit on, or make deduction from, the loan under the Note because we pay these taxes and charges. We will provide Lender with proof of payment upon request.

(b) MAINTENANCE: We will maintain the building(s) on the Premises in good condition. We will not make major changes in the building(s) except for normal repairs. We will not tear down any of the building(s) on the Premises without first getting Lender's consent. We will not use the Premises illegally. If this Mortgage is on a unit in a condominium or a planned unit development, we shall perform all of our obligations under the declaration or covenants creating or governing the condominium or planned unit development, the by-laws and regulations of the condominium or planned unit development and constituent documents.

(c) INSURANCE: We will keep the building(s) on the Premises insured at all time against loss, by fire, flood and any other hazards Lender may specify. We may choose the insurance company, but our choice is subject to Lender's reasonable approval. The policies must be for at least the amounts and the time periods that Lender specifies. We will deliver to Lender upon Lender's request the policies of other proof of the insurance. The policies must name Lender as "mortgagee" and "loss-payee" so that Lender will receive payment on all insurance claims, to the extent of this Mortgage, before we do. The insurance policies must also provide that Lender be given not less than 10 days prior written notice of any cancellation or reduction in coverage, for any reason. Upon request, we shall deliver the policies, certificates or other evidence of insurance to Lender. In the event of loss or damage to the Premises, we will immediately notify Lender in writing and file a proof of loss with the insurer. Lender may file a proof of loss on our behalf if we fail or refuse to do so. Lender may also sign our name to any check, draft or other order for the payment of insurance proceeds in the event of loss or damage to the Premises. If Lender receives payment of a claim, Lender will have the right to choose to use the money either to repair the Premises or to reduce the amount owing on the Note.

(d) CONDEMNATION: We assign to Lender the proceeds of any award or claim for damages, direct or consequential, in connection with any condemnation or other taking of the Premises, or part thereof, or for conveyance in lieu of condemnation, all of which shall be paid to Lender, subject to the terms of any Prior Mortgage.

DOC ID #: 00013884536807006

(e) SECURITY INTEREST: We will join with you in signing and filing documents and, at our expense, in doing whatever you believe is necessary to perfect and continue the perfection of your lien and security interest in the Premises. It is agreed that the Lender shall be subrogated to the claims and liens of all parties whose claims or liens are discharged or paid with the proceeds of the Agreement secured hereby.

OUR AUTHORITY TO YOU: If we fail to perform our obligations under this Mortgage, Lender may, if Lender chooses, perform our obligations and pay such costs and expenses. Lender will add the amounts Lender advances to the sums owing on the Note, on which Lender will charge interest at the interest rate set forth in the Note. If, for example, we fail to honor our promises to maintain insurance in effect, or to pay filing fees, taxes or the costs necessary to keep the Premises in good condition and repair or to perform any of our agreements with Lender, Lender may, if Lender chooses, advance any sums to satisfy any of our agreements with Lender or MERS and charge us interest on such advances at the interest rate set forth in the Note. This Mortgage secures all such advances. Lender's payments on our behalf will not cure our failure to perform our promises in this Mortgage. Any replacement insurance that Lender obtains to cover loss or damages to the Premises may be limited to the amount owing on the Note plus the amount of any Prior Mortgages.

(g) PRIOR MORTGAGE: If the provisions of this paragraph are completed, this Mortgage is subject and subordinate to a prior mortgage dated 08/03/2006 and given by us to

AWL as mortgagee, in the original amount of \$ 650,000.00 (the "Prior Mortgage"). We shall not increase, amend or modify the Prior Mortgage without your prior written consent and shall upon receipt of any written notice from the holder of the Prior Mortgage promptly deliver a copy of such notice to you. We shall pay and perform all of our obligations under the Prior Mortgage as and when required under the Prior Mortgage.

(h) HAZARDOUS SUBSTANCES: We shall not cause or permit the presence, use, disposal, storage, or release of any Hazardous Substances on or in the Premises. We shall not do, nor allow anyone else to do, anything affecting the Premises that is in violation of any Environmental Law. The preceding two sentences shall not apply to the presence, use, or storage on the Premises of small quantities of Hazardous Substances that are generally recognized to be appropriate to normal residential uses and to maintenance of the Premises. As used in this paragraph, "Hazardous Substances" are those substances defined as toxic or hazardous substances by Environmental Law and the following substances: gasoline, kerosene, other flammable or toxic petroleum products, toxic pesticides and herbicides, volatile solvents, materials containing asbestos or formaldehyde, and radioactive materials. As used in this paragraph, "Environmental Law" means federal laws and laws of the jurisdiction where the Premises are located that relate to health, safety or environmental protection.

(i) SALE OF PREMISES: We will not sell, transfer ownership of, mortgage or otherwise dispose of our interest in the Premises, in whole or in part, or permit any other lien or claim against the Premises without Lender's prior written consent.

(j) INSPECTION: We will permit Lender to inspect the Premises at any reasonable time.

NO LOSS OF RIGHTS: The Note and this Mortgage may be negotiated or assigned without releasing us or the Premises. Lender may add or release any person or property obligated under the Note and this Mortgage with losing rights in the Premises.

DEFAULT: Except as may be prohibited by applicable law, and subject to any advance notice and cure period if required by applicable law, if any event or condition of default as described in the Note occurs, Lender may foreclose upon this Mortgage. This means that Lender may arrange for the Premises to be sold, as provided by law, in order to pay off what we owe on the Note and under this Mortgage. If the money Lender receive from the sale is not enough to pay off what we owe, we will still owe the difference which Lender may seek to collect from us in accordance with applicable law. In addition, Lender may, in accordance with applicable law, (i) enter on and take possession of the Premises; (ii) collect the rental payments, including over-due rental payments, directly from tenants; (iii) manage the Premises; and (iv) sign, cancel and change leases. We agree that the interest rate set forth in the Note will continue before and after a default, entry of a judgment and foreclosure. In addition, Lender shall be entitled to collect all reasonable fees and costs actually incurred by Lender in proceeding to foreclosure, including, but not limited to, reasonable attorneys fees and costs of documentary evidence, abstracts and title reports.

ASSIGNMENT OF RENTS; APPOINTMENT OF RECEIVER: As additional security, we assign to you the rents of the Premises. You or a receiver appointed by the courts shall be entitled to enter upon, take possession of and manage the Premises and collect the rents of the Premises including those past due.

INITIALS: 

DOC ID #: 00013884536807006

**WAIVERS:** To the extent permitted by applicable law, we waive and release any error or defects in proceedings to enforce this Mortgage and hereby waive the benefit of any present or future laws providing for stay of execution, extension of time, exemption from attachment, levy and sale and homestead exemption.

**BINDING EFFECT:** Each of us shall be fully responsible for all of the promises and agreements in this Mortgage. Until the Note has been paid in full and the obligation to make further advances under the Note has been terminated, the provisions of this Mortgage will be binding on us, our legal representatives, our heirs and all future owners of the Premises. This Mortgage is for MERS and Lender's benefit and for the benefit of anyone to whom it may be assigned. Upon payment in full of all amounts owing under the Note and this Mortgage, and provided any obligation to make further advances under the Note has terminated, this Mortgage and your rights in the Premises shall end.

**NOTICE:** Except for any notice required under applicable law to be given in another manner, (a) any notice to us provided for in this Deed of Trust shall be given by delivering it or by mailing such notice by regular first class mail addressed to us at the last address appearing in your records or at such other address as we may designate by notice to you as provided herein, and (b) any notice to you shall be given by certified mail, return receipt requested, to your address at

For MERS:  
P.O. Box 2026, Flint, MI 48501-2026

For Lender:  
210 N. UNIVERSITY DR STE 601, CORAL SPRINGS, FL 33071  
or to such other address as you may designate by notice to us. Any notice provided for in this Mortgage shall be deemed to have been given to us or you when given in the manner designated herein.

**RELEASE:** Upon payment of all sums secured by this Mortgage and provided the obligation to make further advances under the Note has terminated, you shall discharge this Mortgage without charge to us, except that we shall pay any fees for recording of a satisfaction of this Mortgage.

**GENERAL:** You can waive or delay enforcing any of your rights under this Mortgage without losing them. Any waiver by you of any provisions of this Mortgage will not be a waiver of that or any other provision on any other occasion.

  
Initials: RBZ  
GAJ

DOC ID #: 00013884536807006

THIS MORTGAGE has been signed by each of us under seal on the date first above written.

WITNESS:

*[Handwritten signatures]*  
\_\_\_\_\_

*Jean Pierre Jeanglaude*  
Mortgagor: JEAN B. JEANGLAUDE (SEAL)  
11 HEMMING DR  
STAFFORD, VA 22554

*Gertrude Arthur Jeanglaude*  
Mortgagor: GERTRUDE ARTHUR JEANGLAUDE (SEAL)  
11 HEMMING DR  
STAFFORD, VA 22554

\_\_\_\_\_  
Mortgagor: (SEAL)

\_\_\_\_\_  
Mortgagor: (SEAL)

STATE OF ~~FLORIDA~~ <sup>Va.</sup> County ss: *Fairfax*  
The foregoing instrument was acknowledged before me this August 3, 2006 by  
JEAN B. JEANGLAUDE AND GERTRUDE ARTHUR JEANGLAUDE  
who is personally known to me or who has produced driver's licenses as identification.

*[Signature]*  
Notary Public *Comm Expires 3/31/07*

Prepared by: YVETTE ZAPATA

**GL FINANCIAL SERVICES, LLC.**

DATE: 08/03/2006

CASE#:

DOC ID#: 00013884536807006

BORROWER: JEAN B. JEANGLAUDE

PROPERTY ADDRESS: 8671 THORNBROOK TERRACE POINT  
BOYNTON BEACH, FL 33437

210 N. UNIVERSITY DR STE 601

CORAL SPRINGS, FL 33071

Phone: (954)825-4300

Brk Fax No.: (954)825-4320

**LEGAL DESCRIPTION EXHIBIT A**

Lot 117, CANYON ISLES PLAT ONE, according to teh plat thereof, as recorded in Plat Book 105 at Page 1 of the Public Records of Palm Beach County, Florida

FHA/VA/CONV  
Legal Description Exhibit A  
2C404-XX (04/03)(d)

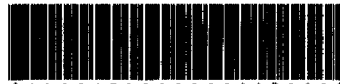
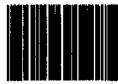

This is not a certified copy

**PLANNED UNIT DEVELOPMENT RIDER**

After Recording Return To:  
COUNTRYWIDE HOME LOANS, INC.  
MS SV-79 DOCUMENT PROCESSING  
P.O.Box 10423  
Van Nuys, CA 91410-0423

Prepared By:  
YVETTE ZAPATA  
GL FINANCIAL SERVICES, LLC.

210 N. UNIVERSITY DR STE 7601  
CORAL SPRINGS, FL 33071

00013884536807006  
[Doc ID #]

THIS PLANNED UNIT DEVELOPMENT RIDER is made this THIRD day of AUGUST, 2006, and is incorporated into and shall be deemed to amend and supplement the Mortgage, Deed of Trust, or Security Deed (the "Security Instrument") of the same date, given by the undersigned (the "Borrower") to secure Borrower's Note to GL FINANCIAL SERVICES, LLC.

(the "Lender") of the same date and covering the Property described in the Security Instrument and located at:

8671 THORNBROOK TERRACE POINT  
BOYNTON BEACH, FL 33437  
[Property Address]

The Property includes, but is not limited to, a parcel of land improved with a dwelling, together with

MULTISTATE PUD RIDER - Single Family - Fannie Mae/Freddie Mac UNIFORM INSTRUMENT  
VMS-7R (0405) CHL (06/04)(d) Page 1 of 3 Initials: [Signature] GAJ  
VMP Mortgage Solutions, Inc. (800)521-7291 Form 3150 /01





This document is not a contract

DOC ID #: 00013884536807006

other such parcels and certain common areas and facilities, as described in THE COVENANTS, CONDITIONS, AND RESTRICTIONS FILED OF RECORD THAT AFFECT THE PROPERTY ORB 19820, PG 216

(the "Declaration"). The Property is a part of a planned unit development known as CANYON ISLES

[Name of Planned Unit Development]

(the "PUD"). The Property also includes Borrower's interest in the homeowners association or equivalent entity owning or managing the common areas and facilities of the PUD (the "Owners Association") and the uses, benefits and proceeds of Borrower's interest.

PUD COVENANTS. In addition to the covenants and agreements made in the Security Instrument, Borrower and Lender further covenant and agree as follows:

A. PUD Obligations. Borrower shall perform all of Borrower's obligations under the PUD's Constituent Documents. The "Constituent Documents" are the (i) Declaration; (ii) articles of incorporation, trust instrument or any equivalent document which creates the Owners Association; and (iii) any by-laws or other rules or regulations of the Owners Association. Borrower shall promptly pay, when due, all dues and assessments imposed pursuant to the Constituent Documents.

B. Property Insurance. So long as the Owners Association maintains, with a generally accepted insurance carrier, a "master" or "blanket" policy insuring the Property which is satisfactory to Lender and which provides insurance coverage in the amounts (including deductible levels), for the periods, and against loss by fire, hazards included within the term "extended coverage," and any other hazards, including, but not limited to, earthquakes and floods, for which Lender requires insurance, then: (i) Lender waives the provision in Section 3 for the Periodic Payment to Lender of the yearly premium installments for property insurance on the Property; and (ii) Borrower's obligation under Section 5 to maintain property insurance coverage on the Property is deemed satisfied to the extent that the required coverage is provided by the Owners Association policy.

What Lender requires as a condition of this waiver can change during the term of the loan.

Borrower shall give Lender prompt notice of any lapse in required property insurance coverage provided by the master or blanket policy.

In the event of a distribution of property insurance proceeds in lieu of restoration or repair following a loss to the Property, or to common areas and facilities of the PUD, any proceeds payable to Borrower are hereby assigned and shall be paid to Lender. Lender shall apply the proceeds to the sums secured by the Security Instrument, whether or not then due, with the excess, if any, paid to Borrower.

C. Public Liability Insurance. Borrower shall take such actions as may be reasonable to insure that the Owners Association maintains a public liability insurance policy acceptable in form, amount, and extent of coverage to Lender.

D. Condemnation. The proceeds of any award or claim for damages, direct or consequential, payable to Borrower in connection with any condemnation or other taking of all or any part of the Property or the common areas and facilities of the PUD, or for any conveyance in lieu of condemnation, are hereby assigned and shall be paid to Lender. Such proceeds shall be applied by Lender to the sums secured by the Security Instrument as provided in Section 11.

E. Lender's Prior Consent. Borrower shall not, except after notice to Lender and with Lender's prior written consent, either partition or subdivide the Property or consent to: (i) the abandonment or termination of the PUD, except for abandonment or termination required by law in the case of substantial destruction by fire or other casualty or in the case of a taking by condemnation or eminent domain; (ii) any amendment to any provision of the "Constituent Documents" if the provision is for the

7-7R (0405)

CHL (06/04)

Page 2 of 3

Initials: JBSJ GAJ Form 3150 1/01

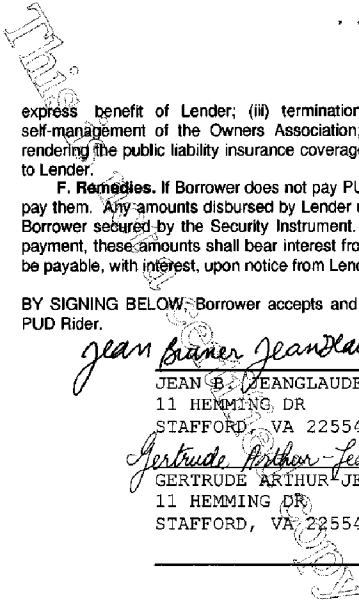

DOC ID #: 00013884536807006

express benefit of Lender; (iii) termination of professional management and assumption of self-management of the Owners Association; or (iv) any action which would have the effect of rendering the public liability insurance coverage maintained by the Owners Association unacceptable to Lender.

F. Remedies. If Borrower does not pay PUD dues and assessments when due, then Lender may pay them. Any amounts disbursed by Lender under this paragraph F shall become additional debt of Borrower secured by the Security Instrument. Unless Borrower and Lender agree to other terms of payment, these amounts shall bear interest from the date of disbursement at the Note rate and shall be payable, with interest, upon notice from Lender to Borrower requesting payment.

BY SIGNING BELOW, Borrower accepts and agrees to the terms and provisions contained in this PUD Rider.

*Jean Braxer Jeanglaude*

\_\_\_\_\_(Seal)  
JEAN B. JEANGLAUE - Borrower  
11 HEMMING DR  
STAFFORD, VA 22554

*Gertrude Arthur Jeanglaude*

\_\_\_\_\_(Seal)  
GERTRUDE ARTHUR JEANGLAUE - Borrower  
11 HEMMING DR  
STAFFORD, VA 22554

\_\_\_\_\_(Seal)  
- Borrower

\_\_\_\_\_(Seal)  
- Borrower

This is Not a Certified Copy

SECOND HOME RIDER

After Recording Return To:
COUNTRYWIDE HOME LOANS, INC.
MS SV-79 DOCUMENT PROCESSING
P.O.Box 10423
Van Nuys, CA 91410-0423

Prepared By:
YVETTE ZAPATA
GL FINANCIAL SERVICES, LLC.

210 N. UNIVERSITY DR STE 600
CORAL SPRINGS, FL 33071

00013884536807006
[Doc ID #]

THIS SECOND HOME RIDER is made this THIRD day of
AUGUST, 2006, and is incorporated into and shall be deemed to amend and supplement
the Mortgage, Deed of Trust, or Security Deed (the "Security Instrument") of the same date given by the
undersigned (the "Borrower" whether there are one or more persons undersigned) to secure Borrower's Note to
GL FINANCIAL SERVICES, LLC.

(the "Lender") of the same date and covering the Property described in the Security Instrument (the "Property"),
which is located at:

8671 THORNBROOK TERRACE POINT
BOYNTON BEACH, FL 33437
[Property Address]

MULTISTATE SECOND HOME RIDER - Single Family - Fannie Mae/Freddie Mac UNIFORM
INSTRUMENT Page 1 of 2 Initials: [Signature]
VMP-365R (0405) CHL (06/04)(d) Form 3890 1/01
VMP Mortgage Solutions, Inc. (800)521-7291



This document is unrecorded

DOC ID #: 00013884536807006

In addition to the covenants and agreements made in the Security Instrument, Borrower and Lender further covenant and agree that Sections 6 and 8 of the Security Instrument are deleted and are replaced by the following:

**6. Occupancy.** Borrower shall occupy, and shall only use, the Property as Borrower's second home. Borrower shall keep the Property available for Borrower's exclusive use and enjoyment at all times, and shall not subject the Property to any timesharing or other shared ownership arrangement or to any rental pool or agreement that requires Borrower either to rent the Property or give a management firm or any other person any control over the occupancy or use of the Property.

**8. Borrower's Loan Application.** Borrower shall be in default if, during the Loan application process, Borrower or any persons or entities acting at the direction of Borrower or with Borrower's knowledge or consent gave materially false, misleading, or inaccurate information or statements to Lender (or failed to provide Lender with material information) in connection with the Loan. Material representations include, but are not limited to, representations concerning Borrower's occupancy of the Property as Borrower's second home.

BY SIGNING BELOW, Borrower accepts and agrees to the terms and provisions contained in this Second Home Rider.

*Jean Bourne Jean Claude*

\_\_\_\_\_(Seal)  
- Borrower  
JEAN B. JEANGLAUDE  
11 HEMMING DR  
STAFFORD, VA 22554

*Gertrude Arthur - Jean Claude*

\_\_\_\_\_(Seal)  
- Borrower  
GERTRUDE ARTHUR - JEANGLAUDE  
11 HEMMING DR  
STAFFORD, VA 22554

\_\_\_\_\_(Seal)  
- Borrower

\_\_\_\_\_(Seal)  
- Borrower



Document Prepared By:  
Stephan L. Galiano  
ReconTrust Company, N.A.  
1330 W. Southern Ave.  
MS: TPSA-88  
Tempe, AZ 85282-4545  
(800) 540-2684

CFN 20070183108  
OR BK 21628 PG 0225  
RECORDED 04/16/2007 15:01:26  
Palm Beach County, Florida  
Sharon R. Bock, CLERK & COMPTROLLER  
Pg 0225; (1pg)

When recorded return to:  
JEAN B JEANGLAUE, GERTRUDE ARTHUR-JEANGLAUE  
11 Hemming Dr  
Stafford, VA 22554

DOCID#0001388453782005N

**SATISFACTION OF MORTGAGE**

KNOW ALL MEN BY THESE PRESENTS: Mortgage Electronic Registration Systems, Inc. the owner and holder of a certain mortgage deed executed by JEAN B JEANGLAUE, GERTRUDE ARTHUR-JEANGLAUE to Mortgage Electronic Registration Systems, Inc. bearing date 08/03/2006, recorded on 08/08/2006 in Official Records Book OR 20706, Page 0327, Instrument # 20060482328 in the office of the Clerk of the Circuit Court of PALM BEACH County State of Florida, securing a certain note in the principal sum of \$850,000.00 Dollars, and certain promises and obligations set forth in said mortgage deed, upon the property situated in said State and County hereby acknowledge full payment and satisfaction of said note and mortgage deed, and surrenders the same as canceled, and hereby directs the Clerk of the said Circuit Court to cancel the same of record.

IN WITNESS WHEREOF the said Corporation has caused these presents to be executed in its name, and its corporate seal to be hereunto affixed, by its proper officers thereunto duly authorized, the 04 day of April, 2007.

(CORPORATE SEAL)

Mortgage Electronic Registration Systems, Inc.

ATTEST   
Melissa Van Blarcom  
Assistant Secretary

Signed and delivered in the presence of:

Alexandria Redfin  
Witness

By   
Stacey Shirra  
Assistant Secretary

STATE OF ARIZONA  
COUNTY OF MARICOPA

On 04/04/2007, before me, Christine Jones, Notary Public, personally appeared Stacey Shirra personally known to me (or proved to me on the basis of satisfactory evidence) to be the person whose name is subscribed to the within instrument and acknowledged to me that he/she executed the same in his/her authorized capacity, and that by his/her signature on the instrument the person, or the entity upon behalf of which the person acted, executed the instrument.

Witness my hand and official seal.  
  
Christine Jones, Notary Public  
Expires: 12/21/2009



Document Prepared By:  
Steven U. Gallano  
ReconTrust Company, N.A.  
1330 W. Southern Ave.  
MS: TPSA-88  
Tempe, AZ 85282-4545  
(800) 540-2684



CFN 20070185466  
OR BK 21632 PG 1381  
RECORDED 04/17/2007 14:52:07  
Palm Beach County, Florida  
Sharon R. Bock, CLERK & COMPTROLLER  
Pg 1381; (1pg)

This is a photocopy

When recorded return to:  
JEAN B JEANGLAUDE, GERTRUDE ARTHUR-JEANGLAU  
11 HEMMING DRIVE  
STAFFORD, VA 22554

DOCID#0001368453682005N

SATISFACTION OF MORTGAGE

KNOW ALL MEN BY THESE PRESENTS: Mortgage Electronic Registration Systems, Inc. the owner and holder of a certain mortgage deed executed by JEAN B JEANGLAUDE, GERTRUDE ARTHUR-JEANGLAU to Mortgage Electronic Registration Systems, Inc. bearing date 08/03/2006, recorded on 08/08/2006 in Official Records Book 20706, Page 0344, Instrument # 20060462329 in the office of the Clerk of the Circuit Court of PALM BEACH County State of Florida, securing a certain note in the principal sum of \$141,120.00 Dollars, and certain promises and obligations set forth in said mortgage deed, upon the property situated in said State and County hereby acknowledge full payment and satisfaction of said note and mortgage deed, and surrenders the same as canceled, and hereby directs the Clerk of the said Circuit Court to cancel the same of record.

(CORPORATE SEAL)

IN WITNESS WHEREOF the said Corporation has caused these presents to be executed in its name, and its corporate seal to be hereunto affixed, by its proper officers thereunto duly authorized, the 03 day of April, 2007.

Mortgage Electronic Registration Systems, Inc.

ATTEST:

Roxanne Bermea  
Assistant Secretary

Signed and delivered in the presence of:

Monica Castro  
Witness

By

Peter Lopez  
Assistant Secretary

STATE OF ARIZONA  
COUNTY OF MARICOPA

On 04/03/2007, before me, Mary H. Doyle, Notary Public, personally appeared Peter Lopez personally known to me (or proved to me on the basis of satisfactory evidence) to be the person whose name is subscribed to the within instrument and acknowledged to me that he/she executed the same in his/her authorized capacity, and that by his/her signature on the instrument the person, or the entity upon behalf of which the person acted, executed the instrument.

Witness my hand and official seal.

Mary H. Doyle, Notary Public  
Expires: 08/18/2009





Recording Requested by &  
When Recorded Return To:  
US Recordings, Inc.  
PO Box 19989  
Louisville, KY 40259

CFN 20070188785  
OR BK 21639 PG 1219  
RECORDED 04/19/2007 08:35:21  
Palm Beach County, Florida  
AMT 807,000.00  
Deed Doc 2,824.50  
Intang 1,614.00  
Sharon R. Bock, CLERK & COMPTROLLER  
Pgs 1219 - 1236; (18pgs)

This document was prepared by  
HEATHER MCLAUGHLIN  
COUNTRYWIDE HOME LOANS, INC.  
2380 PERFORMANCE DR MSRGV  
C931  
RICHARDSON  
TX 75082

[Space Above This Line For Recording Data]

38337630

165970934

00016597093403007

(Escrow/Closing #)

(Doc ID #)

**MORTGAGE**

MIN 1000157 0007938670 7

T007-040958  
DMR/NREIS

**DEFINITIONS**

Words used in multiple sections of this document are defined below and other words are defined in Sections 3, 11, 13, 18, 20 and 21. Certain rules regarding the usage of words used in this document are also provided in Section 16.

(A) "Security Instrument" means this document, which is dated MARCH 30, 2007, together with all Riders to this document.

(B) "Borrower" is

JEAN BRONER JEANGLAUBE, AND GERTRUDE ARTHUR-JEANGLAUBE, HUSBAND AND WIFE

Borrower is the mortgagor under this Security Instrument.

(C) "MERS" is Mortgage Electronic Registration Systems, Inc. MERS is a separate corporation that is acting solely as a nominee for Lender and Lender's successors and assigns. MERS is the mortgagee under this Security Instrument. MERS is organized and existing under the laws of Delaware, and has an address and telephone number of P.O. Box 2026, Fint, MI 48301-2026, tel. (888) 679-MERS.

(D) "Lender" is

COUNTRYWIDE HOME LOANS, INC.

Lender is a CORPORATION

organized and existing under the laws of NEW YORK

Lender's address is

4500 Park Granada MSN# 5VB-314, Calabasas, CA 91302-1613

(E) "Note" means the promissory note signed by Borrower and dated MARCH 30, 2007. The Note states that Borrower owes Lender

EIGHT HUNDRED SEVEN THOUSAND and 00/100

Dollars (U.S. \$ 807,000.00) plus interest. Borrower has promised to pay this debt in regular Periodic Payments and to pay the debt in full not later than APRIL 01, 2037

(F) "Property" means the property that is described below under the heading "Transfer of Rights in the Property."

FLORIDA-Single Family-Fannie Mae/Freddie Mac UNIFORM INSTRUMENT WITH MERS

Page 1 of 11

SA(FL) (0005) CON/WVA

CHL (08/05/0)

VMP Mortgage Solutions, Inc. (800)821-7291

Form 3010 1/01

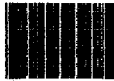

\* 23991 \*

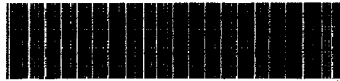

\* 165970934000002006A \*

Handwritten initials: ARJ, WPS

This is a true and correct copy of the original document.

DOC ID #: 00016597093403007

(G) "Loan" means the debt evidenced by the Note, plus interest, any prepayment charges and late charges due under the Note, and all sums due under this Security Instrument, plus interest.

(H) "Riders" means all Riders to this Security Instrument that are executed by Borrower. The following Riders are to be executed by Borrower (check box as applicable):

- Adjustable Rate Rider
- Balloon Rider
- VA Rider
- Condominium Rider
- Planned Unit Development Rider
- Biweekly Payment Rider
- Second Home Rider
- 1-4 Family Rider
- Other(s) (specify)

(I) "Applicable Law" means all controlling applicable federal, state and local statutes, regulations, ordinances and administrative rules and orders (that have the effect of law) as well as all applicable final, non-applicable judicial opinions.

(J) "Community Association Dues, Fees, and Assessments" means all dues, fees, assessments and other charges that are imposed on Borrower or the Property by a condominium association, homeowners association or similar organization.

(K) "Electronic Funds Transfer" means any transfer of funds, other than a transaction originated by check, draft, or similar paper instrument, which is initiated through an electronic terminal, telephonic instrument, computer, or magnetic tape so as to order, instruct, or authorize a financial institution to debit or credit an account. Such term includes, but is not limited to, point-of-sale transfers, automated teller machine transactions, transfers initiated by telephone, wire transfers, and automated clearinghouse transfers.

(L) "Escrow Items" means those items that are described in Section 3.

(M) "Miscellaneous Proceeds" means any compensation, settlement, award of damages, or proceeds paid by any third party (other than insurance proceeds paid under the coverages described in Section 5) for: (i) damage to, or destruction of, the Property; (ii) condemnation or other taking of all or any part of the Property; (iii) conveyance in lieu of condemnation; or (iv) misrepresentations of, or omissions as to, the value and/or condition of the Property.

(N) "Mortgage Insurance" means insurance protecting Lender against the nonpayment of, or default on, the Loan.

(O) "Periodic Payment" means the regularly scheduled amount due for (i) principal and interest under the Note, plus (ii) any amounts under Section 3 of this Security Instrument.

(P) "RESPA" means the Real Estate Settlement Procedures Act (12 U.S.C. Section 2601 et seq.) and its implementing regulation, Regulation X (24 C.F.R. Part 3500), as they might be amended from time to time, or any additional or successor legislation or regulation that governs the same subject matter. As used in this Security Instrument, "RESPA" refers to all requirements and restrictions that are imposed in regard to a "federally related mortgage loan" even if the Loan does not qualify as a "federally related mortgage loan" under RESPA.

(Q) "Successor in Interest of Borrower" means any party that has taken title to the Property, whether or not that party has assumed Borrower's obligations under the Note and/or this Security Instrument.

TRANSFER OF RIGHTS IN THE PROPERTY

This Security Instrument secures to Lender: (i) the repayment of the Loan, and all renewals, extensions and modifications of the Note; and (ii) the performance of Borrower's covenants and agreements under this Security Instrument and the Note. For this purpose, Borrower does hereby mortgage, grant and convey to MERS (solely as nominee for Lender and Lender's successors and assigns) and to the successors and assigns of MERS, the following described property located in the

COUNTY of PALM BEACH ;  
[Type of Recording Jurisdiction] [Name of Recording Jurisdiction]

SEE EXHIBIT "A" ATTACHED HERETO AND MADE A PART HEREOF.

Handwritten initials: RM, GRS



06-42-45-32-03-00-1170  
Parcel ID Number:

DOC ID #: 00016597093403007

which currently has the address of

8671 THORNBROOK TERRACE PT, BOYNTON BEACH

[Street/City]

Florida 33437-4882 ("Property Address"):

[Zip Code]

TOGETHER WITH all the improvements now or hereafter erected on the property, and all easements, appurtenances, and fixtures now or hereafter a part of the property. All replacements and additions shall also be covered by this Security Instrument. All of the foregoing is referred to in this Security Instrument as the "Property." Borrower understands and agrees that MERS holds only legal title to the interests granted by Borrower in this Security Instrument, but, if necessary to comply with law or custom, MERS (as nominee for Lender and Lender's successors and assigns) has the right to exercise any or all of those interests, including, but not limited to, the right to foreclose and sell the Property; and to take any action required of Lender including, but not limited to, releasing and canceling this Security Instrument.

BORROWER COVENANTS that Borrower is lawfully seized of the estate hereby conveyed and has the right to mortgage, grant and convey the Property and that the Property is unencumbered, except for encumbrances of record. Borrower warrants and will defend generally the title to the Property against all claims and demands, subject to any encumbrances of record.

THIS SECURITY INSTRUMENT combines uniform covenants for national use and non-uniform covenants with limited variations by jurisdiction to constitute a uniform security instrument covering real property.

UNIFORM COVENANTS. Borrower and Lender covenant and agree as follows:

1. **Payment of Principal, Interest, Escrow Items, Prepayment Charges, and Late Charges.** Borrower shall pay when due the principal of, and interest on, the debt evidenced by the Note and any prepayment charges and late charges due under the Note. Borrower shall also pay funds for Escrow Items pursuant to Section 3. Payments due under the Note and this Security Instrument shall be made in U.S. currency. However, if any check or other instrument received by Lender as payment under the Note or this Security Instrument is returned to Lender unpaid, Lender may require that any or all subsequent payments due under the Note and this Security Instrument be made in one or more of the following forms, as selected by Lender: (a) cash; (b) money order; (c) certified check, bank check, treasurer's check or cashier's check, provided any such check is drawn upon an institution whose deposits are insured by a federal agency, instrumentality, or entity; or (d) Electronic Funds Transfer.

Payments are deemed received by Lender when received at the location designated in the Note or at such other location as may be designated by Lender in accordance with the notice provisions in Section 15. Lender may return any payment or partial payment if the payment or partial payments are insufficient to bring the Loan current. Lender may accept any payment or partial payment insufficient to bring the Loan current, without waiver of any rights hereunder or prejudice to its rights to refuse such payment or partial payments in the future, but Lender is not obligated to apply such payments at the time such payments are accepted. If each Periodic Payment is applied as of its scheduled due date, then Lender need not pay interest on unapplied funds. Lender may hold such unapplied funds until Borrower makes payment to bring the Loan current. If Borrower does not do so within a reasonable period of time, Lender shall either apply such funds or return them to Borrower. If not applied earlier, such funds will be applied to the outstanding principal balance under the Note immediately prior to foreclosure. No offset or claim which Borrower might have now or in the future against Lender shall relieve Borrower from making payments due under the Note and this Security Instrument or performing the covenants and agreements secured by this Security Instrument.

2. **Application of Payments or Proceeds.** Except as otherwise described in this Section 2, all payments accepted and applied by Lender shall be applied in the following order of priority: (a) interest due under the Note; (b) principal due under the Note; (c) amounts due under Section 3. Such payments shall be applied to each Periodic Payment in the order in which it became due. Any remaining amounts shall be applied first to late charges, second to any other amounts due under this Security Instrument, and then to reduce the principal balance of the Note.

If Lender receives a payment from Borrower for a delinquent Periodic Payment which includes a sufficient amount to pay any late charge due, the payment may be applied to the delinquent payment and the late charge. If more than one Periodic Payment is outstanding, Lender may apply any payment received from Borrower to the repayment of the Periodic Payments if, and to the extent that, each payment can be paid in full. To the extent that any excess exists after the payment is applied to the full payment of one or more Periodic Payments, such excess may be applied to any late charges due. Voluntary prepayments shall be applied first to any prepayment charges and then as described in the Note.

MM GAT

This

DOC ID #: 00016597093403007

Any application of payments, insurance proceeds, or Miscellaneous Proceeds to principal due under the Note shall not extend or postpone the due date, or change the amount, of the Periodic Payments.

3. Funds for Escrow Items. Borrower shall pay to Lender on the day Periodic Payments are due under the Note, until the Note is paid in full, a sum (the "Funds") to provide for payment of amounts due for: (a) taxes and assessments and other items which can attain priority over this Security Instrument as a lien or encumbrance on the Property; (b) leasehold payments or ground rents on the Property, if any; (c) premiums for any and all insurance required by Lender under Section 5; and (d) Mortgage Insurance premiums, if any, or any sums payable by Borrower to Lender in lieu of the payment of Mortgage Insurance premiums in accordance with the provisions of Section 10. These items are called "Escrow Items." At origination or at any time during the term of the Loan, Lender may require that Community Association Dues, Fees, and Assessments, if any, be escrowed by Borrower, and such dues, fees and assessments shall be an Escrow Item. Borrower shall promptly furnish to Lender all notices of amounts to be paid under this Section. Borrower shall pay Lender the Funds for Escrow Items unless Lender waives Borrower's obligation to pay the Funds for any or all Escrow Items. Lender may waive Borrower's obligation to pay to Lender Funds for any or all Escrow Items at any time. Any such waiver may only be in writing. In the event of such waiver, Borrower shall pay directly, when and where payable, the amounts due for any Escrow Items for which payment of Funds has been waived by Lender and, if Lender requires, shall furnish to Lender receipts evidencing such payment within such time period as Lender may require. Borrower's obligation to make such payments and to provide receipts shall for all purposes be deemed to be a covenant and agreement contained in this Security Instrument, as the phrase "covenant and agreement" is used in Section 9, if Borrower is obligated to pay Escrow Items directly, pursuant to a waiver, and Borrower fails to pay the amount due for an Escrow Item, Lender may exercise its rights under Section 9 and pay such amount and Borrower shall then be obligated under Section 9 to repay to Lender any such amount. Lender may revoke the waiver as to any or all Escrow Items at any time by a notice given in accordance with Section 15 and, upon such revocation, Borrower shall pay to Lender all Funds, and in such amounts, that are then required under this Section 3.

Lender may, at any time, collect and hold Funds in an amount (a) sufficient to permit Lender to apply the Funds at the time specified under RESPA, and (b) not to exceed the maximum amount a lender can require under RESPA. Lender shall estimate the amount of Funds due on the basis of current data and reasonable estimates of expenditures of future Escrow items or otherwise in accordance with Applicable Law.

The Funds shall be held in an institution whose deposits are insured by a federal agency, instrumentality, or entity (including Lender, if Lender is an institution whose deposits are so insured) or in any Federal Home Loan Bank. Lender shall apply the Funds to pay the Escrow Items no later than the time specified under RESPA. Lender shall not charge Borrower for holding and applying the Funds, annually analyzing the escrow account, or verifying the Escrow Items, unless Lender pays Borrower interest on the Funds and Applicable Law permits Lender to make such a charge. Unless an agreement is made in writing or Applicable Law requires interest to be paid on the Funds, Lender shall not be required to pay Borrower any interest or earnings on the Funds. Borrower and Lender can agree in writing, however, that interest shall be paid on the Funds. Lender shall give to Borrower, without charge, an annual accounting of the Funds as required by RESPA.

If there is a surplus of Funds held in escrow, as defined under RESPA, Lender shall account to Borrower for the excess funds in accordance with RESPA. If there is a shortage of Funds held in escrow, as defined under RESPA, Lender shall notify Borrower as required by RESPA, and Borrower shall pay to Lender the amount necessary to make up the shortage in accordance with RESPA, but in no more than 12 monthly payments. If there is a deficiency of Funds held in escrow, as defined under RESPA, Lender shall notify Borrower as required by RESPA, and Borrower shall pay to Lender the amount necessary to make up the deficiency in accordance with RESPA, but in no more than 12 monthly payments.

Upon payment in full of all sums secured by this Security Instrument, Lender shall promptly refund to Borrower any Funds held by Lender.

4. Charges; Liens. Borrower shall pay all taxes, assessments, charges, fines, and impositions attributable to the Property which can attain priority over this Security Instrument, leasehold payments or ground rents on the Property, if any, and Community Association Dues, Fees, and Assessments, if any. To the extent that these items are Escrow Items, Borrower shall pay them in the manner provided in Section 3.

Borrower shall promptly discharge any lien which has priority over this Security Instrument unless Borrower: (a) agrees in writing to the payment of the obligation secured by the lien in a manner acceptable to Lender, but only so long as Borrower is performing such agreement; (b) contests the lien in good faith by, or defends against enforcement of the lien in, legal proceedings which in Lender's opinion operate to prevent the enforcement of the lien while those proceedings are pending, but only until such proceedings are concluded; or (c) secures from the holder of the lien an agreement satisfactory to Lender subordinating the lien to this Security Instrument. If Lender determines that any part of the Property is subject to a lien which can attain priority over this Security Instrument, Lender may give Borrower a notice identifying the lien. Within 10 days of the date on which that notice is given, Borrower shall satisfy the lien or take one or more of the actions set forth above in this Section 4.

AAA GAG

This

DOC ID #: 00016597093403007

Lender may require Borrower to pay a one-time charge for a real estate tax verification and/or reporting service used by Lender in connection with this Loan.

5. Property Insurance. Borrower shall keep the improvements now existing or hereafter erected on the Property insured against loss by fire, hazards included within the term "extended coverage," and any other hazards including, but not limited to, earthquakes and floods, for which Lender requires insurance. This insurance shall be maintained in the amounts (including deductible levels) and for the periods that Lender requires. What Lender requires pursuant to the preceding sentences can change during the term of the Loan. The insurance carrier providing the insurance shall be chosen by Borrower subject to Lender's right to disapprove Borrower's choice, which right shall not be exercised unreasonably. Lender may require Borrower to pay, in connection with this Loan, either: (a) a one-time charge for flood zone determination, certification and tracking services; or (b) a one-time charge for flood zone determination and certification services and subsequent charges each time remappings or similar changes occur which reasonably might affect such determination or certification. Borrower shall also be responsible for the payment of any fees imposed by the Federal Emergency Management Agency in connection with the review of any flood zone determination resulting from an objection by Borrower.

If Borrower fails to maintain any of the coverages described above, Lender may obtain insurance coverage, at Lender's option and Borrower's expense. Lender is under no obligation to purchase any particular type or amount of coverage. Therefore, such coverage shall cover Lender, but might or might not protect Borrower, Borrower's equity in the Property, or the contents of the Property, against any risk, hazard or liability and might provide greater or lesser coverage than was previously in effect. Borrower acknowledges that the cost of the insurance coverage so obtained might significantly exceed the cost of insurance that Borrower could have obtained. Any amounts disbursed by Lender under this Section 5 shall become additional debt of Borrower secured by this Security Instrument. These amounts shall bear interest at the Note rate from the date of disbursement and shall be payable, with such interest, upon notice from Lender to Borrower requesting payment.

All insurance policies required by Lender and renewals of such policies shall be subject to Lender's right to disapprove such policies, shall include a standard mortgage clause, and shall name Lender as mortgagee and/or as an additional loss payee. Lender shall have the right to hold the policies and renewal certificates. If Lender requires, Borrower shall promptly give to Lender all receipts of paid premiums and renewal notices. If Borrower obtains any form of insurance coverage, not otherwise required by Lender, for damage to, or destruction of, the Property, such policy shall include a standard mortgage clause and shall name Lender as mortgagee and/or as an additional loss payee.

In the event of loss, Borrower shall give prompt notice to the insurance carrier and Lender. Lender may make proof of loss if not made promptly by Borrower. Unless Lender and Borrower otherwise agree in writing, any insurance proceeds, whether or not the underlying insurance was required by Lender, shall be applied to restoration or repair of the Property, if the restoration or repair is economically feasible and Lender's security is not lessened. During such repair and restoration period, Lender shall have the right to hold such insurance proceeds until Lender has had an opportunity to inspect such Property to ensure the work has been completed to Lender's satisfaction, provided that such inspection shall be undertaken promptly. Lender may disburse proceeds for the repairs and restoration in a single payment or in a series of progress payments as the work is completed. Unless an agreement is made in writing or Applicable Law requires interest to be paid on such insurance proceeds, Lender shall not be required to pay Borrower any interest or earnings on such proceeds. Fees for public adjusters, or other third parties, retained by Borrower shall not be paid out of the insurance proceeds and shall be the sole obligation of Borrower. If the restoration or repair is not economically feasible or Lender's security would be lessened, the insurance proceeds shall be applied to the sums secured by this Security Instrument, whether or not then due, with the excess, if any, paid to Borrower. Such insurance proceeds shall be applied in the order provided for in Section 2.

If Borrower abandons the Property, Lender may file, negotiate and settle any available insurance claim and related matters. If Borrower does not respond within 30 days to a notice from Lender that the insurance carrier has offered to settle a claim, then Lender may negotiate and settle the claim. The 30-day period will begin when the notice is given. In either event, or if Lender acquires the Property under Section 22 or otherwise, Borrower hereby assigns to Lender (a) Borrower's rights to any insurance proceeds in an amount not to exceed the amounts unpaid under the Note or this Security Instrument, and (b) any other of Borrower's rights (other than the right to any refund of unearned premiums paid by Borrower) under all insurance policies covering the Property, insofar as such rights are applicable to the coverage of the Property. Lender may use the insurance proceeds either to repair or restore the Property or to pay amounts unpaid under the Note or this Security Instrument, whether or not then due.

MSJ CAS

This

DOC ID #: 00016597093403007

6. **Occupancy.** Borrower shall occupy, establish, and use the Property as Borrower's principal residence within 60 days after the execution of this Security Instrument and shall continue to occupy the Property as Borrower's principal residence for at least one year after the date of occupancy, unless Lender otherwise agrees in writing, which consent shall not be unreasonably withheld, or unless extenuating circumstances exist which are beyond Borrower's control.

7. **Preservation, Maintenance and Protection of the Property; Inspections.** Borrower shall not destroy, damage or impair the Property, allow the Property to deteriorate or commit waste on the Property. Whether or not Borrower is residing in the Property, Borrower shall maintain the Property in order to prevent the Property from deteriorating or decreasing in value due to its condition. Unless it is determined pursuant to Section 5 that repair or restoration is not economically feasible, Borrower shall promptly repair the Property if damaged to avoid further deterioration or damage. If insurance or condemnation proceeds are paid in connection with damage to, or the taking of, the Property, Borrower shall be responsible for repairing or restoring the Property only if Lender has released proceeds for such purposes. Lender may disburse proceeds for the repairs and restoration in a single payment or in a series of progress payments as the work is completed. If the insurance or condemnation proceeds are not sufficient to repair or restore the Property, Borrower is not relieved of Borrower's obligation for the completion of such repair or restoration.

Lender or its agent may make reasonable entries upon and inspections of the Property. If it has reasonable cause, Lender may inspect the interior of the improvements on the Property. Lender shall give Borrower notice at the time of or prior to such an interior inspection specifying such reasonable cause.

8. **Borrower's Loan Application.** Borrower shall be in default if, during the Loan application process, Borrower or any persons or entities acting at the direction of Borrower or with Borrower's knowledge or consent gave materially false, misleading, or inaccurate information or statements to Lender (or failed to provide Lender with material information) in connection with the Loan. Material representations include, but are not limited to, representations concerning Borrower's occupancy of the Property as Borrower's principal residence.

9. **Protection of Lender's Interest in the Property and Rights Under this Security Instrument.** If (a) Borrower fails to perform the covenants and agreements contained in this Security Instrument, (b) there is a legal proceeding that might significantly affect Lender's interest in the Property and/or rights under this Security Instrument (such as a proceeding in bankruptcy, probate, for condemnation or forfeiture, for enforcement of a lien which may attain priority over this Security Instrument or to enforce laws or regulations), or (c) Borrower has abandoned the Property, then Lender may do and pay for whatever is reasonable or appropriate to protect Lender's interest in the Property and rights under this Security Instrument, including protecting and/or assessing the value of the Property, and securing and/or repairing the Property. Lender's actions can include, but are not limited to: (a) paying any sums secured by a lien which has priority over this Security Instrument; (b) appearing in court; and (c) paying reasonable attorneys' fees to protect its interest in the Property and/or rights under this Security Instrument, including its secured position in a bankruptcy proceeding. Securing the Property includes, but is not limited to, entering the Property to make repairs, change locks, replace or board up doors and windows, drain water from pipes, eliminate building or other code violations or dangerous conditions, and have utilities turned on or off. Although Lender may take action under this Section 9, Lender does not have to do so and is not under any duty or obligation to do so. It is agreed that Lender incurs no liability for not taking any or all actions authorized under this Section 9.

Any amounts disbursed by Lender under this Section 9 shall become additional debt of Borrower secured by this Security Instrument. These amounts shall bear interest at the Note rate from the date of disbursement and shall be payable, with such interest, upon notice from Lender to Borrower requesting payment.

If this Security Instrument is on a leasehold, Borrower shall comply with all the provisions of the lease. If Borrower acquires fee title to the Property, the leasehold and the fee title shall not merge unless Lender agrees to the merger in writing.

10. **Mortgage Insurance.** If Lender required Mortgage Insurance as a condition of making the Loan, Borrower shall pay the premiums required to maintain the Mortgage Insurance in effect. If, for any reason, the Mortgage Insurance coverage required by Lender ceases to be available from the mortgage insurer that previously provided such insurance and Borrower was required to make separately designated payments toward the premiums for Mortgage Insurance, Borrower shall pay the premiums required to obtain coverage substantially equivalent to the Mortgage Insurance previously in effect, at a cost substantially equivalent to the cost to Borrower of the Mortgage Insurance previously in effect, from an alternate mortgage insurer selected by Lender. If substantially equivalent Mortgage Insurance coverage is not available, Borrower shall continue to pay to Lender the amount of the separately designated payments that were due when the insurance coverage ceased to be in effect. Lender will accept, use and retain these payments as a non-refundable loss reserve in lieu of Mortgage Insurance. Such loss reserve shall be non-refundable, notwithstanding the fact that the Loan is ultimately paid in full, and Lender shall not be required to pay Borrower any interest or earnings on such loss reserve. Lender can no longer require loss reserve payments if Mortgage Insurance coverage (in the

Handwritten signature: M. G. J.

This

DOC ID #: 00016597093403007

amount and for the period that Lender requires) provided by an insurer selected by Lender again becomes available, is obtained, and Lender requires separately designated payments toward the premiums for Mortgage Insurance. If Lender required Mortgage Insurance as a condition of making the Loan and Borrower was required to make separately designated payments toward the premiums for Mortgage Insurance, Borrower shall pay the premiums required to maintain Mortgage Insurance in effect, or to provide a non-refundable loss reserve, until Lender's requirement for Mortgage Insurance ends in accordance with any written agreement between Borrower and Lender providing for such termination or until termination is required by Applicable Law. Nothing in this Section 10 affects Borrower's obligation to pay interest at the rate provided in the Note.

Mortgage Insurance reimburses Lender (or any entity that purchases the Note) for certain losses it may incur if Borrower does not repay the Loan as agreed. Borrower is not a party to the Mortgage Insurance.

Mortgage insurers evaluate their total risk on all such insurance in force from time to time, and may enter into agreements with other parties that share or modify their risk, or reduce losses. These agreements are on terms and conditions that are satisfactory to the mortgage insurer and the other party (or parties) to these agreements. These agreements may require the mortgage insurer to make payments using any source of funds that the mortgage insurer may have available (which may include funds obtained from Mortgage Insurance premiums).

As a result of these agreements, Lender, any purchaser of the Note, another insurer, any reinsurer, any other entity, or any affiliate of any of the foregoing, may receive (directly or indirectly) amounts that derive from (or might be characterized as) a portion of Borrower's payments for Mortgage Insurance, in exchange for sharing or modifying the mortgage insurer's risk, or reducing losses. If such agreement provides that an affiliate of Lender takes a share of the insurer's risk in exchange for a share of the premiums paid to the insurer, the arrangement is often termed "captive reinsurance." Further:

(a) Any such agreements will not affect the amounts that Borrower has agreed to pay for Mortgage Insurance, or any other terms of the Loan. Such agreements will not increase the amount Borrower will owe for Mortgage Insurance, and they will not entitle Borrower to any refund.

(b) Any such agreements will not affect the rights Borrower has - if any - with respect to the Mortgage Insurance under the Homeowners Protection Act of 1998 or any other law. These rights may include the right to receive certain disclosures, to request and obtain cancellation of the Mortgage Insurance, to have the Mortgage Insurance terminated automatically, and/or to receive a refund of any Mortgage Insurance premiums that were unearned at the time of such cancellation or termination.

11. Assignment of Miscellaneous Proceeds; Forfeiture. All Miscellaneous Proceeds are hereby assigned to and shall be paid to Lender.

If the Property is damaged, such Miscellaneous Proceeds shall be applied to restoration or repair of the Property, if the restoration or repair is economically feasible and Lender's security is not lessened. During such repair and restoration period, Lender shall have the right to hold such Miscellaneous Proceeds until Lender has had an opportunity to inspect such Property to ensure the work has been completed to Lender's satisfaction, provided that such inspection shall be undertaken promptly. Lender may pay for the repairs and restoration in a single disbursement or in a series of progress payments as the work is completed. Unless an agreement is made in writing or Applicable Law requires interest to be paid on such Miscellaneous Proceeds, Lender shall not be required to pay Borrower any interest or earnings on such Miscellaneous Proceeds. If the restoration or repair is not economically feasible or Lender's security would be lessened, the Miscellaneous Proceeds shall be applied to the sums secured by this Security Instrument, whether or not then due, with the excess, if any, paid to Borrower. Such Miscellaneous Proceeds shall be applied in the order provided for in Section 2.

In the event of a total taking, destruction, or loss in value of the Property, the Miscellaneous Proceeds shall be applied to the sums secured by this Security Instrument, whether or not then due, with the excess, if any, paid to Borrower.

In the event of a partial taking, destruction, or loss in value of the Property in which the fair market value of the Property immediately before the partial taking, destruction, or loss in value is equal to or greater than the amount of the sums secured by this Security Instrument immediately before the partial taking, destruction, or loss in value, unless Borrower and Lender otherwise agree in writing, the sums secured by this Security Instrument shall be reduced by the amount of the Miscellaneous Proceeds multiplied by the following fraction: (a) the total amount of the sums secured immediately before the partial taking, destruction, or loss in value divided by (b) the fair market value of the Property immediately before the partial taking, destruction, or loss in value. Any balance shall be paid to Borrower.

In the event of a partial taking, destruction, or loss in value of the Property in which the fair market value of the Property immediately before the partial taking, destruction, or loss in value is less than the amount of the sums secured immediately before the partial taking, destruction, or loss in value, unless Borrower and Lender otherwise agree in writing, the Miscellaneous Proceeds shall be applied to the sums secured by this Security Instrument whether or not the sums are then due.

JMS CMO

This

DOC ID #: 00016597093403097

If the Property is abandoned by Borrower, or if, after notice by Lender to Borrower that the Opposing Party (as defined in the next sentence) offers to make an award to settle a claim for damages, Borrower fails to respond to Lender within 30 days after the date the notice is given, Lender is authorized to collect and apply the Miscellaneous Proceeds either to restoration or repair of the Property or to the sums secured by this Security Instrument, whether or not then due. "Opposing Party" means the third party that owes Borrower Miscellaneous Proceeds or the party against whom Borrower has a right of action in regard to Miscellaneous Proceeds.

Borrower shall be in default if any action or proceeding, whether civil or criminal, is begun that, in Lender's judgment, could result in forfeiture of the Property or other material impairment of Lender's interest in the Property or rights under this Security Instrument. Borrower can cure such a default and, if acceleration has occurred, reinstate as provided in Section 19, by causing the action or proceeding to be dismissed with a ruling that, in Lender's judgment, precludes forfeiture of the Property or other material impairment of Lender's interest in the Property or rights under this Security Instrument. The proceeds of any award or claim for damages that are attributable to the impairment of Lender's interest in the Property are hereby assigned and shall be paid to Lender.

All Miscellaneous Proceeds that are not applied to restoration or repair of the Property shall be applied in the order provided for in Section 7.

**12. Borrower Not Released; Forbearance By Lender Not a Waiver.** Extension of the time for payment or modification of amortization of the sums secured by this Security Instrument granted by Lender to Borrower or any Successor in Interest of Borrower shall not operate to release the liability of Borrower or any Successors in Interest of Borrower. Lender shall not be required to commence proceedings against any Successor in Interest of Borrower or to refuse to extend time for payment or otherwise modify amortization of the sums secured by this Security Instrument by reason of any demand made by the original Borrower or any Successors in Interest of Borrower. Any forbearance by Lender in exercising any right or remedy including, without limitation, Lender's acceptance of payments from third persons, entities or Successors in Interest of Borrower or in amounts less than the amount then due, shall not be a waiver of or preclude the exercise of any right or remedy.

**13. Joint and Several Liability; Co-signers; Successors and Assigns Bound.** Borrower covenants and agrees that Borrower's obligations and liability shall be joint and several. However, any Borrower who co-signs this Security Instrument but does not execute the Note (a "co-signer"): (a) is co-signing this Security Instrument only to mortgage, grant and convey the co-signer's interest in the Property under the terms of this Security Instrument; (b) is not personally obligated to pay the sums secured by this Security Instrument; and (c) agrees that Lender and any other Borrower can agree to extend, modify, forbear or make any accommodations with regard to the terms of this Security Instrument or the Note without the co-signer's consent.

Subject to the provisions of Section 18, any Successor in Interest of Borrower who assumes Borrower's obligations under this Security Instrument in writing, and is approved by Lender, shall obtain all of Borrower's rights and benefits under this Security Instrument. Borrower shall not be released from Borrower's obligations and liability under this Security Instrument unless Lender agrees to such release in writing. The covenants and agreements of this Security Instrument shall bind (except as provided in Section 20) and benefit the successors and assigns of Lender.

**14. Loan Charges.** Lender may charge Borrower fees for services performed in connection with Borrower's default, for the purpose of protecting Lender's interest in the Property and rights under this Security Instrument, including, but not limited to, attorneys' fees, property inspection and valuation fees. In regard to any other fees, the absence of express authority in this Security Instrument to charge a specific fee to Borrower shall not be construed as a prohibition on the charging of such fee. Lender may not charge fees that are expressly prohibited by this Security Instrument or by Applicable Law.

If the Loan is subject to a law which sets maximum loan charges, and that law is finally interpreted so that the interest or other loan charges collected or to be collected in connection with the Loan exceed the permitted limits, then: (a) any such loan charge shall be reduced by the amount necessary to reduce the charge to the permitted limit; and (b) any sums already collected from Borrower which exceeded permitted limits will be refunded to Borrower. Lender may choose to make this refund by reducing the principal owed under the Note or by making a direct payment to Borrower. If a refund reduces principal, the reduction will be treated as a partial prepayment without any prepayment charge (whether or not a prepayment charge is provided for under the Note). Borrower's acceptance of any such refund made by direct payment to Borrower will constitute a waiver of any right of action Borrower might have arising out of such overcharge.

**15. Notices.** All notices given by Borrower or Lender in connection with this Security Instrument must be in writing. Any notice to Borrower in connection with this Security Instrument shall be deemed to have been given to Borrower when mailed by first class mail or when actually delivered to Borrower's notice address if sent by other means. Notice to any one Borrower shall constitute notice to all Borrowers unless Applicable Law expressly requires otherwise. The notice address shall be the Property Address unless

MSJ GAS

Three

DOC ID #: 00016597093403007

Borrower has designated a substitute notice address by notice to Lender. Borrower shall promptly notify Lender of Borrower's change of address. If Lender specifies a procedure for reporting Borrower's change of address, then Borrower shall only report a change of address through that specified procedure. There may be only one designated notice address under this Security Instrument at any one time. Any notice to Lender shall be given by delivering it or by mailing it by first class mail to Lender's address stated herein unless Lender has designated another address by notice to Borrower. Any notice in connection with this Security Instrument shall not be deemed to have been given to Lender until actually received by Lender. If any notice required by this Security Instrument is also required under Applicable Law, the Applicable Law requirement will satisfy the corresponding requirement under this Security Instrument.

**16. Governing Law; Severability; Rules of Construction.** This Security Instrument shall be governed by federal law and the law of the jurisdiction in which the Property is located. All rights and obligations contained in this Security Instrument are subject to any requirements and limitations of Applicable Law. Applicable Law might explicitly or implicitly allow the parties to agree by contract or it might be silent, but such silence shall not be construed as a prohibition against agreement by contract. In the event that any provision or clause of this Security Instrument or the Note conflicts with Applicable Law, such conflict shall not affect other provisions of this Security Instrument or the Note which can be given effect without the conflicting provision.

As used in this Security Instrument: (a) words of the masculine gender shall mean and include corresponding neuter words or words of the feminine gender; (b) words in the singular shall mean and include the plural and vice versa; and (c) the word "may" gives sole discretion without any obligation to take any action.

**17. Borrower's Copy.** Borrower shall be given one copy of the Note and of this Security Instrument.

**18. Transfer of the Property or a Beneficial Interest in Borrower.** As used in this Section 18, "Interest in the Property" means any legal or beneficial interest in the Property, including, but not limited to, those beneficial interests transferred in a bond for deed, contract for deed, installment sales contract or escrow agreement, the intent of which is the transfer of title by Borrower at a future date to a purchaser.

If all or any part of the Property or any interest in the Property is sold or transferred (or if Borrower is not a natural person and a beneficial interest in Borrower is sold or transferred) without Lender's prior written consent, Lender may require immediate payment in full of all sums secured by this Security Instrument. However, this option shall not be exercised by Lender if such exercise is prohibited by Applicable Law.

If Lender exercises this option, Lender shall give Borrower notice of acceleration. The notice shall provide a period of not less than 30 days from the date the notice is given in accordance with Section 15 within which Borrower must pay all sums secured by this Security Instrument. If Borrower fails to pay these sums prior to the expiration of this period, Lender may invoke any remedies permitted by this Security Instrument without further notice or demand on Borrower.

**19. Borrower's Right to Reinstate After Acceleration.** If Borrower meets certain conditions, Borrower shall have the right to have enforcement of this Security Instrument discontinued at any time prior to the earliest of: (a) five days before sale of the Property pursuant to any power of sale contained in this Security Instrument; (b) such other period as Applicable Law might specify for the termination of Borrower's right to reinstate; or (c) entry of a judgment enforcing this Security Instrument. Those conditions are that Borrower: (a) pays Lender all sums which then would be due under this Security Instrument and the Note as if no acceleration had occurred; (b) cures any default of any other covenants or agreements; (c) pays all expenses incurred in enforcing this Security Instrument, including, but not limited to, reasonable attorneys' fees, property inspection and valuation fees, and other fees incurred for the purpose of protecting Lender's interest in the Property and rights under this Security Instrument; and (d) takes such action as Lender may reasonably require to assure that Lender's interest in the Property and rights under this Security Instrument, and Borrower's obligation to pay the sums secured by this Security Instrument, shall continue unchanged. Lender may require that Borrower pay such reinstatement sums and expenses in one or more of the following forms, as selected by Lender: (a) cash; (b) money order; (c) certified check, bank check, treasurer's check or cashier's check, provided any such check is drawn upon an institution whose deposits are insured by a federal agency, instrumentality or entity; or (d) Electronic Funds Transfer. Upon reinstatement by Borrower, this Security Instrument and obligations secured hereby shall remain fully effective as if no acceleration had occurred. However, this right to reinstate shall not apply in the case of acceleration under Section 18.

**20. Sale of Note; Change of Loan Servicer; Notice of Grievance.** The Note or a partial interest in the Note (together with this Security Instrument) can be sold one or more times without prior notice to Borrower. A sale might result in a change in the entity (known as the "Loan Servicer") that collects Periodic Payments due under the Note and this Security Instrument and performs other mortgage loan servicing obligations under the Note, this Security Instrument, and Applicable Law. There also might be one or more changes of the Loan Servicer unrelated to a sale of the Note. If there is a change of the Loan Servicer, Borrower will be given written notice of the change which will state the name and address of the new Loan Servicer, the address to

*Handwritten initials/signature*

THIS

DOC ID #: 00016597093403007

which payments should be made and any other information RESPA requires in connection with a notice of transfer of servicing. If the Note is sold and thereafter the Loan is serviced by a Loan Servicer other than the purchaser of the Note, the mortgage loan servicing obligations to Borrower will remain with the Loan Servicer or be transferred to a successor Loan Servicer and are not assumed by the Note purchaser unless otherwise provided by the Note purchaser.

Neither Borrower nor Lender may commence, join, or be joined to any judicial action (as either an individual litigant or the member of a class) that arises from the other party's actions pursuant to this Security Instrument or that alleges that the other party has breached any provision of, or any duty owed by reason of, this Security Instrument, until such Borrower or Lender has notified the other party (with such notice given in compliance with the requirements of Section 15) of such alleged breach and afforded the other party hereto a reasonable period after the giving of such notice to take corrective action. If Applicable Law provides a time period which must elapse before certain action can be taken, that time period will be deemed to be reasonable for purposes of this paragraph. The notice of acceleration and opportunity to cure given to Borrower pursuant to Section 22 and the notice of acceleration given to Borrower pursuant to Section 18 shall be deemed to satisfy the notice and opportunity to take corrective action provisions of this Section 20.

**21. Hazardous Substances.** As used in this Section 21: (a) "Hazardous Substances" are those substances defined as toxic or hazardous substances, pollutants, or wastes by Environmental Law and the following substances: gasoline, kerosene, other flammable or toxic petroleum products, toxic pesticides and herbicides, volatile solvents, materials containing asbestos or formaldehyde, and radioactive materials; (b) "Environmental Law" means federal laws and laws of the jurisdiction where the Property is located that relate to health, safety or environmental protection; (c) "Environmental Cleanup" includes any response action, remedial action, or removal action, as defined in Environmental Law; and (d) an "Environmental Condition" means a condition that can cause, contribute to, or otherwise trigger an Environmental Cleanup.

Borrower shall not cause or permit the presence, use, disposal, storage, or release of any Hazardous Substances, or threaten to release any Hazardous Substances, on or in the Property. Borrower shall not do, nor allow anyone else to do, anything affecting the Property (a) that is in violation of any Environmental Law, (b) which creates an Environmental Condition, or (c) which, due to the presence, use, or release of a Hazardous Substance, creates a condition that adversely affects the value of the Property. The preceding two sentences shall not apply to the presence, use, or storage on the Property of small quantities of Hazardous Substances that are generally recognized to be appropriate to normal residential uses and to maintenance of the Property (including, but not limited to, hazardous substances in consumer products).

Borrower shall promptly give Lender written notice of (a) any investigation, claim, demand, lawsuit or other action by any governmental or regulatory agency or private party involving the Property and any Hazardous Substance or Environmental Law of which Borrower has actual knowledge, (b) any Environmental Condition, including but not limited to, any spilling, leaking, discharge, release or threat of release of any Hazardous Substance, and (c) any condition caused by the presence, use or release of a Hazardous Substance which adversely affects the value of the Property. If Borrower learns, or is notified by any governmental or regulatory authority, or any private party, that any removal or other remediation of any Hazardous Substance affecting the Property is necessary, Borrower shall promptly take all necessary remedial actions in accordance with Environmental Law. Nothing herein shall create any obligation on Lender for an Environmental Cleanup.

NON-UNIFORM COVENANTS. Borrower and Lender further covenant and agree as follows:

**22. Acceleration; Remedies.** Lender shall give notice to Borrower prior to acceleration following Borrower's breach of any covenant or agreement in this Security Instrument (but not prior to acceleration under Section 18 unless Applicable Law provides otherwise). The notice shall specify: (a) the default; (b) the action required to cure the default; (c) a date, not less than 30 days from the date the notice is given to Borrower, by which the default must be cured; and (d) that failure to cure the default on or before the date specified in the notice may result in acceleration of the sums secured by this Security Instrument, foreclosure by judicial proceeding and sale of the Property. The notice shall further inform Borrower of the right to reinstate after acceleration and the right to assert in the foreclosure proceeding the non-existence of a default or any other defense of Borrower to acceleration and foreclosure. If the default is not cured on or before the date specified in the notice, Lender at its option may require immediate payment in full of all sums secured by this Security Instrument without further demand and may foreclose this Security Instrument by judicial proceeding. Lender shall be entitled to collect all expenses incurred in pursuing the remedies provided in this Section 22, including, but not limited to, reasonable attorneys' fees and costs of title evidence.

**23. Release.** Upon payment of all sums secured by this Security Instrument, Lender shall release this Security Instrument. Borrower shall pay any recordation costs. Lender may charge Borrower a fee for releasing this Security Instrument, but only if the fee is paid to a third party for services rendered and the charging of the fee is permitted under Applicable Law.

MS 00



DOC ID #: 00016597093403007

24. Attorneys' Fees. As used in this Security Instrument and the Note, attorneys' fees shall include those awarded by an appellate court and any attorneys' fees incurred in a bankruptcy proceeding.

25. Jury Trial Waiver. The Borrower hereby waives any right to a trial by jury in any action, proceeding, claim, or counterclaim, whether in contract or tort, at law or in equity, arising out of or in any way related to this Security Instrument or the Note.

BY SIGNING BELOW, Borrower accepts and agrees to the terms and covenants contained in this Security Instrument and in any Rider executed by Borrower and recorded with it.

Signed, sealed and delivered in the presence of:

*Ec Booth* Jean Bruner Jeanclaude (Seal)  
JEAN BRUNER JEANCLAUDE -Borrower

11 HEMMING DR (Address)  
STARFORD, VA 22554

*Ec Booth* Gertrude Arthur Jeanclaude (Seal)  
GERTRUDE ARTHUR-JEANCLAUDE -Borrower

11 HEMMING DR (Address)  
STARFORD, VA 22554

\_\_\_\_ (Seal)  
\_\_\_\_ -Borrower

\_\_\_\_ (Address)

\_\_\_\_ (Seal)

\_\_\_\_ -Borrower

\_\_\_\_ (Address)

STATE OF FLORIDA, Palm Beach County ss:  
The foregoing instrument was acknowledged before me this MARCH 30 2007 by  
JEAN B. JEANCLAUDE & GERTRUDE A. JEANCLAUDE

who is personally known to me or who has produced Driver's License as identification.

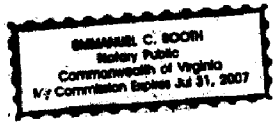

*Emmanuel C. Booth*  
\_\_\_\_\_  
Notary Public  
Emmanuel C. Booth

This is not a certified copy

PLANNED UNIT DEVELOPMENT RIDER

After Recording Return To:
COUNTRYWIDE HOME LOANS, INC.
MS SV-78 DOCUMENT PROCESSING
P.O. Box 10483
Van Nuys, CA 91410-0423

Prepared By:
HEATHER MCLAUGHLIN
COUNTRYWIDE HOME LOANS, INC.

2380 PERFORMANCE DR MSRGV
C931
RICHARDSON
TX 75082

165970934 00016597093403007
[Escrow/Closing #] [Doc ID #]

THIS PLANNED UNIT DEVELOPMENT RIDER is made this THIRTIETH day of
MARCH, 2007, and is incorporated into and shall be deemed to amend and supplement
the Mortgage, Deed of Trust, or Security Deed (the "Security Instrument") of the same date, given by
the undersigned (the "Borrower") to secure Borrower's Note to
COUNTRYWIDE HOME LOANS, INC.

(the "Lender") of the same date and covering the Property described in the Security Instrument and
located at:

8671 THORNBROOK TERRACE PT
BOYNTON BEACH, FL 33437-4882
[Property Address]

The Property includes, but is not limited to, a parcel of land improved with a dwelling, together with

MULTISTATE PUD RIDER - Single Family - Fannie Mae/Freddie Mac UNIFORM INSTRUMENT
VMP -7R (0405) CHL (06/04)(d) Page 1 of 3 Initials JBY/CAJ
VMP Mortgage Solutions, Inc. (800)521-7291 Form 3150 1/01



This is Not a Contract

DOC ID #: 00016597093403007

other such parcels and certain common areas and facilities, as described in THE COVENANTS, CONDITIONS, AND RESTRICTIONS FILED OF RECORD THAT AFFECT THE PROPERTY

(the "Declaration"). The Property is a part of a planned unit development known as CANYON ISLES

[Name of Planned Unit Development]

(the "PUD"). The Property also includes Borrower's interest in the homeowners association or equivalent entity owning or managing the common areas and facilities of the PUD (the "Owners Association") and the uses, benefits and proceeds of Borrower's interest.

**PUD COVENANTS.** In addition to the covenants and agreements made in the Security Instrument, Borrower and Lender further covenant and agree as follows:

**A. PUD Obligations.** Borrower shall perform all of Borrower's obligations under the PUD's Constituent Documents. The "Constituent Documents" are the (i) Declaration; (ii) articles of incorporation, trust instrument or any equivalent document which creates the Owners Association; and (iii) any by-laws or other rules or regulations of the Owners Association. Borrower shall promptly pay, when due, all dues and assessments imposed pursuant to the Constituent Documents.

**B. Property Insurance.** So long as the Owners Association maintains, with a generally accepted insurance carrier, a "master" or "blanket" policy insuring the Property which is satisfactory to Lender and which provides insurance coverage in the amounts (including deductible levels), for the periods, and against loss by fire, hazards included within the term "extended coverage," and any other hazards, including, but not limited to, earthquakes and floods, for which Lender requires insurance, then: (i) Lender waives the provision in Section 3 for the Periodic Payment to Lender of the yearly premium installments for property insurance on the Property; and (ii) Borrower's obligation under Section 5 to maintain property insurance coverage on the Property is deemed satisfied to the extent that the required coverage is provided by the Owners Association policy.

What Lender requires as a condition of this waiver can change during the term of the loan.

Borrower shall give Lender prompt notice of any lapse in required property insurance coverage provided by the master or blanket policy.

In the event of a distribution of property insurance proceeds in lieu of restoration or repair following a loss to the Property, or to common areas and facilities of the PUD, any proceeds payable to Borrower are hereby assigned and shall be paid to Lender. Lender shall apply the proceeds to the sums secured by the Security Instrument, whether or not then due, with the excess, if any, paid to Borrower.

**C. Public Liability Insurance.** Borrower shall take such actions as may be reasonable to insure that the Owners Association maintains a public liability insurance policy acceptable in form, amount, and extent of coverage to Lender.

**D. Condemnation.** The proceeds of any award or claim for damages, direct or consequential, payable to Borrower in connection with any condemnation or other taking of all or any part of the Property or the common areas and facilities of the PUD, or for any conveyance in lieu of condemnation, are hereby assigned and shall be paid to Lender. Such proceeds shall be applied by Lender to the sums secured by the Security Instrument as provided in Section 11.

**E. Lender's Prior Consent.** Borrower shall not, except after notice to Lender and with Lender's prior written consent, either partition or subdivide the Property or consent to: (i) the abandonment or termination of the PUD, except for abandonment or termination required by law in the case of substantial destruction by fire or other casualty or in the case of a taking by condemnation or eminent domain; (ii) any amendment to any provision of the "Constituent Documents" if the provision is for the

This

DOC ID #: 00016597093403007

express benefit of Lender; (iii) termination of professional management and assumption of self-management of the Owners Association; or (iv) any action which would have the effect of rendering the public liability insurance coverage maintained by the Owners Association unacceptable to Lender.

F. Remedies. If Borrower does not pay PUD dues and assessments when due, then Lender may pay them. Any amounts disbursed by Lender under this paragraph F shall become additional debt of Borrower secured by the Security Instrument. Unless Borrower and Lender agree to other terms of payment, these amounts shall bear interest from the date of disbursement at the Note rate and shall be payable, with interest, upon notice from Lender to Borrower requesting payment.

BY SIGNING BELOW, Borrower accepts and agrees to the terms and provisions contained in this PUD Rider.

*Jean Bruner Jeanglaude* (Seal)  
JEAN BRUNER JEANGLAUDE - Borrower  
11 HEMMING DR  
STAFFORD, VA 22554

*Gertrude Arthur Jeanglaude* (Seal)  
GERTRUDE ARTHUR JEANGLAUDE - Borrower  
11 HEMMING DR  
STAFFORD, VA 22554

\_\_\_\_ (Seal)  
- Borrower

\_\_\_\_ (Seal)  
- Borrower

This is not a certified copy

**1-4 FAMILY RIDER**  
(Assignment of Rents)

After Recording Return To:  
COUNTRYWIDE HOME LOANS, INC.  
MS SV-79 DOCUMENT PROCESSING  
P.O. Box 10423  
Van Nuys, CA 91410-0423

Prepared By:  
HEATHER MCLAUGHLIN  
COUNTRYWIDE HOME LOANS, INC.

2380 PERFORMANCE DR MSRGV  
C931  
RICHARDSON

165970934                      00016597093403007  
[Escrow/Closing #]                      [Doc ID #]

THIS 1-4 FAMILY RIDER is made this THIRTIETH day of MARCH, 2007, and is incorporated into and shall be deemed to amend and supplement the Mortgage, Deed of Trust, or Security Deed (the "Security Instrument") of the same date given by the undersigned (the "Borrower") to secure Borrower's Note to COUNTRYWIDE HOME LOANS, INC.

(the "Lender") of the same date and covering the Property described in the Security Instrument and located at:  
8671 THORNBROOK TERRACE PT  
BOYNTON BEACH, FL 33437-4882  
[Property Address]

1-4 FAMILY COVENANTS. In addition to the covenants and agreements made in the Security Instrument, Borrower and Lender further covenant and agree as follows:

MULTISTATE 1-4 FAMILY RIDER - Fannie Mae/Freddie Mac UNIFORM INSTRUMENT  
CHL (06/04)(d) Page 1 of 3  
VMP Mortgage Solutions, Inc. (800)521-7291

Initials: *RSTJ*  
*LSAT*  
Form 3170 1/01



This document is a copy of the original document filed with the court. It is not a certified copy.

DOC ID #: 00016597093403007

**A. ADDITIONAL PROPERTY SUBJECT TO THE SECURITY INSTRUMENT.** In addition to the Property described in the Security Instrument, the following items now or hereafter attached to the Property to the extent they are fixtures are added to the Property description, and shall also constitute the Property covered by the Security Instrument: building materials, appliances and goods of every nature whatsoever now or hereafter located in, on, or used, or intended to be used in connection with the Property, including, but not limited to, those for the purposes of supplying or distributing heating, cooling, electricity, gas, water, air and light, fire prevention and extinguishing apparatus, security and access control apparatus, plumbing, bath tubs, water heaters, water closets, sinks, ranges, stoves, refrigerators, dishwashers, disposals, washers, dryers, awnings, storm windows, storm doors, screens, blinds, shades, curtains and curtain rods, attached mirrors, cabinets, paneling and attached floor coverings, all of which, including replacements and additions thereto, shall be deemed to be and remain a part of the Property covered by the Security Instrument. All of the foregoing together with the Property described in the Security Instrument (or the leasehold estate if the Security Instrument is on a leasehold) are referred to in this 1-4 Family Rider and the Security Instrument as the "Property."

**B. USE OF PROPERTY; COMPLIANCE WITH LAW.** Borrower shall not seek, agree to or make a change in the use of the Property or its zoning classification, unless Lender has agreed in writing to the change. Borrower shall comply with all laws, ordinances, regulations and requirements of any governmental body applicable to the Property.

**C. SUBORDINATE LIENS.** Except as permitted by federal law, Borrower shall not allow any lien inferior to the Security Instrument to be perfected against the Property without Lender's prior written permission.

**D. RENT LOSS INSURANCE.** Borrower shall maintain insurance against rent loss in addition to the other hazards for which insurance is required by Section 5.

**E. "BORROWER'S RIGHT TO REINSTATE" DELETED.** Section 19 is deleted.

**F. BORROWER'S OCCUPANCY.** Unless Lender and Borrower otherwise agree in writing, Section 6 concerning Borrower's occupancy of the Property is deleted.

**G. ASSIGNMENT OF LEASES.** Upon Lender's request after default, Borrower shall assign to Lender all leases of the Property and all security deposits made in connection with leases of the Property. Upon the assignment, Lender shall have the right to modify, extend or terminate the existing leases and to execute new leases, in Lender's sole discretion. As used in this paragraph G, the word "lease" shall mean "sublease" if the Security Instrument is on a leasehold.

**H. ASSIGNMENT OF RENTS; APPOINTMENT OF RECEIVER; LENDER IN POSSESSION.** Borrower absolutely and unconditionally assigns and transfers to Lender all the rents and revenues ("Rents") of the Property, regardless of to whom the Rents of the Property are payable. Borrower authorizes Lender or Lender's agents to collect the Rents, and agrees that each tenant of the Property shall pay the Rents to Lender or Lender's agents. However, Borrower shall receive the Rents until: (i) Lender has given Borrower notice of default pursuant to Section 22 of the Security Instrument, and (ii) Lender has given notice to the tenant(s) that the Rents are to be paid to Lender or Lender's agent. This assignment of Rents constitutes an absolute assignment and not an assignment for additional security only.

If Lender gives notice of default to Borrower: (i) all Rents received by Borrower shall be held by Borrower as trustee for the benefit of Lender only, to be applied to the sums secured by the Security Instrument; (ii) Lender shall be entitled to collect and receive all of the Rents of the Property; (iii) Borrower agrees that each tenant of the Property shall pay all Rents due and unpaid to Lender or Lender's agents upon Lender's written demand to the tenant; (iv) unless applicable law provides otherwise, all Rents collected by Lender or Lender's agents shall be applied first to the costs of taking control of and managing the Property and collecting the Rents, including, but not limited to, attorneys' fees, receiver's fees, premiums on receiver's bonds, repair and

THIS IS A COPY

DOC ID #: 00016597093403007

maintenance costs, insurance premiums, taxes, assessments and other charges on the Property, and then to the sums secured by the Security Instrument; (v) Lender, Lender's agents or any judicially appointed receiver shall be liable to account for only those Rents actually received; and (vi) Lender shall be entitled to have a receiver appointed to take possession of and manage the Property and collect the Rents and profits derived from the Property without any showing as to the inadequacy of the Property as security.

If the Rents of the Property are not sufficient to cover the costs of taking control of and managing the Property and of collecting the Rents any funds expended by Lender for such purposes shall become indebtedness of Borrower to Lender secured by the Security Instrument pursuant to Section 9.

Borrower represents and warrants that Borrower has not executed any prior assignment of the Rents and has not performed, and will not perform, any act that would prevent Lender from exercising its rights under this paragraph.

Lender, or Lender's agents or a judicially appointed receiver, shall not be required to enter upon, take control of or maintain the Property before or after giving notice of default to Borrower. However, Lender, or Lender's agents or a judicially appointed receiver, may do so at any time when a default occurs. Any application of Rents shall not cure or waive any default or invalidate any other right or remedy of Lender. This assignment of Rents of the Property shall terminate when all the sums secured by the Security Instrument are paid in full.

**I. CROSS-DEFAULT PROVISION.** Borrower's default or breach under any note or agreement in which Lender has an interest shall be a breach under the Security Instrument and Lender may invoke any of the remedies permitted by the Security Instrument.

BY SIGNING BELOW, Borrower accepts and agrees to the terms and provisions contained in this 1-4 Family Rider.

*Jean Bruner Jeanglaude*

JEAN BRUNER JEANGLAUDE  
11 HEMMING DR  
STAFFORD, VA 22554

\_\_\_\_\_(Seal)  
- Borrower

*Gertrude Arthur-Jeanglaude*

GERTRUDE ARTHUR-JEANGLAUDE  
11 HEMMING DR  
STAFFORD, VA 22554

\_\_\_\_\_(Seal)  
- Borrower

\_\_\_\_\_(Seal)  
- Borrower

\_\_\_\_\_(Seal)  
- Borrower

EXHIBIT A

SITUATED IN PALM BEACH COUNTY, FLORIDA, THE FOLLOWING DESCRIBED PROPERTY:

LOT 117, CANYON ISLES - PLAT TWO, ACCORDING TO THE PLAT THEREOF, AS RECORDED IN PLAT BOOK 105 AT PAGE 40, OF THE PUBLIC RECORDS OF PALM BEACH COUNTY, FLORIDA.

~~THORN BROOK~~ TERRACE PLACE

ADDRESS: 8671 ~~THORN BROOK~~, BOYNTON BEACH, FL 33437 TAX MAP OR PARCEL ID NO.: 00-42-45-32-03-000-1170

*This is not a certified copy*



**U38332630-01NP18**

MORTGAGE

LOAN# T007-040958

US Recordings



IN THE CIRCUIT COURT FOR PALM BEACH COUNTY, FLORIDA.  
CIVIL DIVISION

CASE NO.

THE BANK OF NEW YORK MELLON FKA THE BANK OF NEW YORK, AS TRUSTEE FOR THE CERTIFICATEHOLDERS, CWALT, INC., ALTERNATIVE LOAN TRUST 2007-12T1 MORTGAGE PASS-THROUGH CERTIFICATES, SERIES 2007-12T1,

Plaintiff,  
vs.

50 2009 CA027485 XXXX NB

JEAN BRUNER JEANGLAUDE; GERTRUDE ARTHUR JEANGLAUDE A/K/A GERTRUDE ARTHUR-JEANGLAUDE; CANYON ISLES HOMEOWNERS ASSOCIATION, INC.; UNKNOWN TENANT NO. 1; UNKNOWN TENANT NO. 2; and ALL UNKNOWN PARTIES CLAIMING INTERESTS BY, THROUGH, UNDER OR AGAINST A NAMED DEFENDANT TO THIS ACTION, OR HAVING OR CLAIMING TO HAVE ANY RIGHT, TITLE OR INTEREST IN THE PROPERTY HEREIN DESCRIBED;

AM

Defendants.

NOTICE OF LIS PENDENS

NOTICE IS HEREBY GIVEN that suit was instituted in the above styled Court on \_\_\_\_\_ 2009, by the above styled Plaintiff against the above styled Defendants. The purpose of the suit is to foreclose a certain mortgage upon the following property:

LOT 117, CANYON ISLES - PLAT TWO, ACCORDING TO THE PLAT THEREOF, AS RECORDED IN PLAT BOOK 105 AT PAGE 40, OF THE PUBLIC RECORDS OF PALM BEACH COUNTY, FLORIDA.

All persons are therefore warned and advised of the pendency of this suit.

SMITH, HIATT & DIAZ, P.A.  
Attorneys for Plaintiff  
PO BOX 11438  
Fort Lauderdale, FL 33339-1438  
Telephone: (954) 564-0071

B:

Robert A. Smith  
Florida Bar No. 116186  
Patrice Tedesco  
Florida Bar No. 0628451  
Gavin MacMillan  
Florida Bar No. 0037641  
Gabrielle Strauss  
Florida Bar No. 0059563  
Glenn Matt Lindsay  
Florida Bar No. 0059200  
Tat-Lin Angus  
Florida Bar No. 0051909  
Annemarie Bui Tedford  
Florida Bar No. 0030143

1183-70318

RECORDED  
PALM BEACH COUNTY  
CIRCUIT CIVIL  
MAR 18 2009  
PM 3:16

IN THE CIRCUIT COURT FOR PALM BEACH COUNTY, FLORIDA.  
CIVIL DIVISION

CASE NO.

THE BANK OF NEW YORK MELLON FKA THE BANK OF NEW YORK, AS TRUSTEE FOR THE CERTIFICATEHOLDERS, CWALT, INC., ALTERNATIVE LOAN TRUST 2007-12T1 MORTGAGE PASS-THROUGH CERTIFICATES, SERIES 2007-12T1,

Plaintiff,  
vs.

50 2009 CA027485 XXXX NB

JEAN BRUNER JEANGLAUDE; GERTRUDE ARTHUR JEANGLAUDE A/K/A GERTRUDE ARTHUR-JEANGLAUDE; CANYON ISLES HOMEOWNERS ASSOCIATION, INC.; UNKNOWN TENANT NO. 1; UNKNOWN TENANT NO. 2; and ALL UNKNOWN PARTIES CLAIMING INTERESTS BY, THROUGH, UNDER OR AGAINST A NAMED DEFENDANT TO THIS ACTION, OR HAVING OR CLAIMING TO HAVE ANY RIGHT, TITLE OR INTEREST IN THE PROPERTY HEREIN DESCRIBED,

AM

Defendants.

NOTICE OF LIS PENDENS

NOTICE IS HEREBY GIVEN that suit was instituted in the above styled Court on \_\_\_\_\_ 2009, by the above styled Plaintiff against the above styled Defendants. The purpose of the suit is to foreclose a certain mortgage upon the following property:

LOT 117, CANYON ISLES - PLAT TWO, ACCORDING TO THE PLAT THEREOF, AS RECORDED IN PLAT BOOK 105 AT PAGE 40, OF THE PUBLIC RECORDS OF PALM BEACH COUNTY, FLORIDA.

All persons are therefore warned and advised of the pendency of this suit.

SMITH, HIATT & DIAZ, P.A.  
Attorneys for Plaintiff  
PO BOX 11438  
Fort Lauderdale, FL 33339-1438  
Telephone: (954) 564-0071

B:

- Robert A. Smith  
Florida Bar No. 116186
- Patrice Tedesco  
Florida Bar No. 0628451
- Gavin MacMillan  
Florida Bar No. 0037641
- Gabrielle Strauss  
Florida Bar No. 0059563
- Glenn Matt Lindsay  
Florida Bar No. 0059200
- Tat-Lin Angus  
Florida Bar No. 0051909
- Annemarie Bui Tedford  
Florida Bar No. 0030143

1183-70318

RECORDED  
PALM BEACH COUNTY  
CIRCUIT CIVIL  
MAR 17 2009  
PM 3:16



CFN 20100076403  
OR BK 23715 PG 1415  
RECORDED 03/01/2010 08:30:07  
Palm Beach County, Florida  
AMT 640,000.00  
Doc Stamp 4,480.00  
Sharon R. Bock, CLERK & COMPTROLLER  
Pgs 1415 - 1416; (2pgs)

This document was prepared by and Return to:  
MICHAEL A. TRINKLER, ESQ.  
MICHAEL A. TRINKLER, P.A.  
5501 University Drive, Suite 101  
Coral Springs, FL 33067  
Phone: (954) 753-5700  
Fax No. (954) 753-5767

TRIM COUNTY

(Reserved for Use by the Clerk)

**WARRANTY DEED**

THIS INDENTURE is made this 5 day of February, 2010, between, JEAN BRUNER JEANGLAUDE and GERTRUDE ARTHUR JEANGLAUDE, husband and wife, party of the first part, and ROMUALD ALTINE and GETOSE ALTINE, husband and wife, whose post office address is: 8671 Thornbrook Terrace Point, Boynton Beach, FL 33437, party of the second part.

**WITNESSETH:**

That the party of the first part, for and in consideration of the sum of TEN AND NO/100 (\$10.00) DOLLARS to them in hand paid by the party of the second part, the receipt whereof is hereby acknowledged, has granted, bargained and sold to the party of the second part, their heirs and assigns forever, the following described land, situate and being in the County of PALM BEACH and State of Florida, to-wit:

Lot 117, CANYON ISLES - PLAT TWO, according to the plat thereof, as recorded in Plat Book 105 at Page 40, of the Public Records of Palm Beach County, Florida.

Folio No.: 00-42-45-32-03-000-1170

**SUBJECT TO:**

1. Taxes for the year 2010, and subsequent years;
2. Conditions, restrictions, limitations and easements of record; without reimposing same;
3. Zoning restrictions, prohibitions and other requirements imposed by governmental authority.

And the party of the first part does hereby fully warrant the title to said land, and will defend the same against the lawful claims of all persons whomsoever.

(Reserved for Use by the Clerk)

IN WITNESS WHEREOF, the party of the first part has hereunto set her hand and seal the day and year first above written.

Signed, Sealed and Delivered  
In the Presence of:

[Signature]  
1<sup>st</sup> Witness Signature  
Print Name of 1<sup>st</sup> Witness: Michelle D. Stearns

Jean Bruner Jeanglaude  
JEAN BRUNER JEANGLAUDE

Dayna Solomey  
2<sup>nd</sup> Witness Signature  
Print Name of 2<sup>nd</sup> Witness: Dayna Solomey

Gertrude Arthur Jeanglaude  
GERTRUDE ARTHUR JEANGLAUDE

Address: 11 Hemming Drive, Stafford, VA 22554

STATE OF Virginia )  
COUNTY OF Stafford ) SS:

The execution of the foregoing instrument was acknowledged before me this 5 day of February, 2010 by, JEAN BRUNER JEANGLAUDE and GERTRUDE ARTHUR JEANGLAUDE, who are personally known to me or who have produced VA drivers license as identification, and who did not take an oath.

My Commission Expires: 6/30/10

Karen Barrons  
Notary Public  
Print Name: Karen Barrons

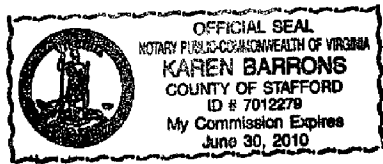

IN THE CIRCUIT COURT FOR PALM BEACH COUNTY, FLORIDA. CIVIL DIVISION

CASE NO. 502009CA027485XXMB(AW)

THE BANK OF NEW YORK MELLON FKA THE BANK OF NEW YORK, AS TRUSTEE FOR THE CERTIFICATEHOLDERS, CWALT, INC., ALTERNATIVE LOAN TRUST 2007-12T1 MORTGAGE PASS-THROUGH CERTIFICATES, SERIES 2007-12T1,

Plaintiff,

vs.

JEAN BRUNER JEANGLAUDE; GERTRUDE ARTHUR JEANGLAUDE A/K/A GERTRUDE ARTHUR-JEANGLAUDE; CANYON ISLES HOMEOWNERS ASSOCIATION, INC.; UNKNOWN TENANT NO. 1; UNKNOWN TENANT NO. 2; and ALL UNKNOWN PARTIES CLAIMING INTERESTS BY, THROUGH, UNDER OR AGAINST A NAMED DEFENDANT TO THIS ACTION, OR HAVING OR CLAIMING TO HAVE ANY RIGHT, TITLE OR INTEREST IN THE PROPERTY HEREIN DESCRIBED,

Defendants.

FILED 2010 JAN 29 PM 4:30 SHARON R. BOCK, CLERK PALM BEACH COUNTY, FL CIVIL DIVISION 1

3-8

SUMMARY FINAL JUDGMENT OF FORECLOSURE

THIS ACTION came before the Court upon pleadings and proofs submitted herein, the motion of the Plaintiff, for the entry of a Summary Final Judgment, and on the evidence presented,

IT IS ADJUDGED THAT:

- 1. This Court has jurisdiction of the subject matter hereof and the parties hereto.

The equities of this action are with the Plaintiff, THE BANK OF NEW YORK MELLON FKA THE BANK OF NEW YORK, AS TRUSTEE FOR THE CERTIFICATEHOLDERS,

**CWALT,INC.,ALTERNATIVE LOAN TRUST 2007-12T1 MORTGAGE PASS-THROUGH**

**CERTIFICATES, SERIES 2007-12T1, There is due to the Plaintiff, the sums of money as hereafter set**

**forth:**

A.	Principal Balance	\$	807,000.00
B.	6.375% interest at \$140.95 per diem from March 1, 2009 thru October 30, 2009	\$	34,097.84
C.	Interest from October 31, 2009 thru January 29, 2010		12,826.45
D.	Advance for Taxes	\$	17,066.99
E.	Pre-Acceleration Late Charges	\$	643.08
F.	Property Preservation Fees	\$	45.00
G.	Title Search	\$	325.00
H.	Filing Fee	\$	1,963.50
I.	Service of Process	\$	475.00
J.	Corporate Search	\$	15.00
K.	Attorneys' Fees	\$	1,450.00
	<b>TOTAL</b>	<b>\$</b>	<b>875,907.86</b>

2. Plaintiff is entitled to receive attorney's fees set forth above as compensation for 12 hours reasonably expended at a rate of \$150.00 per hour, as set forth in the filed affidavit. However, pursuant to the Plaintiff's fee agreement with Smith, Hiatt & Diaz, P.A., the Plaintiff will pay attorneys' fees in the amount of \$1450.00.

3. The original promissory note having been presented and delivered to the Court, Count I of Plaintiff's Complaint is hereby deemed moot.

4. A lien is held by the Plaintiff for the total sum specified in paragraph 1, plus interest, superior in dignity to any right, title, interest, or claim of the Defendants upon the mortgaged property herein foreclosed situate, lying and being in Palm Beach County, Florida, to-wit:

LOT 117, CANYON ISLES – PLAT TWO, ACCORDING TO THE PLAT  
THEREOF, AS RECORDED IN  
PLAT BOOK 105 AT PAGE 40, OF THE PUBLIC RECORDS OF PALM BEACH COUNTY,  
FLORIDA.

5. If the total sum due to the Plaintiff, plus interest on the unpaid principal at the rate prescribed in the note and mortgage to date, and at the current statutory interest rate after the date through which interest is calculated in paragraph 1 above, and all costs of this proceeding incurred after the date of this Judgment are not forthwith paid, the Clerk of this Court shall sell that property at public sale at 10:00 a.m. on the 8 day of MARCH, 2010, to the highest bidder or bidders for cash at the [www.mypalmbeachclerk.clerkauction.com](http://www.mypalmbeachclerk.clerkauction.com), after having first given notice as required by Section 45.031, Florida Statutes.

6. Plaintiff shall advance the cost of publishing the Notice of Sale and shall be reimbursed by the Clerk out of the proceeds of the sale if the Plaintiff is not the purchaser of the property, but such reimbursement will not be by the Clerk unless the Affidavit of Post Judgment Advances has been filed. The purchaser at the sale shall pay, in addition to the amount bid, the Clerk's fee, Clerk's registry fee and documentary stamps to be affixed to the Certificate of Title.

7. The Plaintiff may assign the Judgment or the bid to a third party without further order of the Court.

8. If the Plaintiff or Plaintiff's assignee is the purchaser at the sale, the Clerk shall credit on the bid of the Plaintiff or Plaintiff's assignee the total sum herein found to be due the Plaintiff or such portion thereof as may be necessary to pay fully the bid of the Plaintiff or Plaintiff's assignee.

9. On filing the Certificate of Title, the Clerk shall distribute the proceeds of the sale to Plaintiff c/o Smith, Hiatt & Diaz, P.A., PO BOX 11438, Fort Lauderdale, FL 33339-1438, so far as they are sufficient, by paying:

A. All of Plaintiff's costs,

B. Plaintiff's attorneys' fees,

C. The total sum due to Plaintiff as set forth above, less the items paid, with interest

at the current statutory interest rate from the date through which interest is calculated in paragraph 1 above to the date of the sale. If, subsequent to the date of the Plaintiff's Affidavit of Indebtedness and prior to the sale contemplated in paragraph 5 hereof, the Plaintiff has to advance money to protect its mortgage lien, including but not limited to post judgment advances for property taxes and insurance, property preservation costs, post judgment attorney's fees and costs and post judgment bankruptcy attorney fees and costs, the Plaintiff or its Attorneys shall certify by affidavit to the Clerk and the amount due to Plaintiff shall be increased by the amount of such advances upon further order of the Court.

D. The remaining proceeds, if any, shall be retained by the Clerk pending further Order of the Court.

10. If the United States of America is a Defendant in this action, they shall have the right of redemption provided by 28 U.S.C. §2410(c) from the issuance of a Certificate of Title, but the right shall thereafter expire.

11. Upon filing the Certificate of Sale, the Defendants and all persons claiming under or against them since the filing of the Notice of Lis Pendens shall be foreclosed of all estate or claim in the property, with the exception of any assessments that are superior pursuant to Florida Statutes, Section 718.116 (effective 4/1/1992) or Florida Statutes 720.3085 (effective 7/1/2008), both of which state they are not to be applied retroactively to alter a lien priority existing prior to the effective date of the statute. Upon issuance of the Certificate of Title, the purchaser at the sale shall be let into possession of the property located at 8671 THORNBROOK TERRACE PT, BOYNTON BEACH, FL 33437. Upon further order of the court, the Clerk of the Court is hereby specifically authorized to issue a Writ of Possession for the property which is the subject matter of this action, and the Sheriff is hereby authorized



to serve the Writ forthwith .

12. IF THIS PROPERTY IS SOLD AT PUBLIC AUCTION, THERE MAY BE ADDITIONAL MONEY FROM THE SALE AFTER PAYMENT OF PERSONS WHO ARE ENTITLED TO BE PAID FROM THE SALE PROCEEDS PURSUANT TO THIS FINAL JUDGMENT.

13. IF YOU ARE A SUBORDINATE LIENHOLDER CLAIMING A RIGHT TO FUNDS REMAINING AFTER THE SALE, YOU MUST FILE A CLAIM WITH THE CLERK NO LATER THAN 60 DAYS AFTER THE SALE. IF YOU FAIL TO FILE A CLAIM, YOU WILL NOT BE ENTITLED TO ANY REMAINING FUNDS.

14. IF YOU ARE THE PROPERTY OWNER, YOU MAY CLAIM THESE FUNDS YOURSELF. YOU ARE NOT REQUIRED TO HAVE A LAWYER OR ANY OTHER REPRESENTATION AND YOU DO NOT HAVE TO ASSIGN YOUR RIGHTS TO ANYONE ELSE IN ORDER FOR YOU TO CLAIM ANY MONEY TO WHICH YOU ARE ENTITLED. PLEASE CHECK WITH THE CLERK OF THE COURT, OF PALM BEACH COUNTY WITHIN TEN (10) DAYS AFTER THE SALE TO SEE IF THERE IS ADDITIONAL MONEY FROM THE FORECLOSURE SALE THAT THE CLERK HAS IN THE REGISTRY OF THE COURT.

15. IF YOU DECIDE TO SELL YOUR HOME OR HIRE SOMEONE TO HELP YOU CLAIM THE ADDITIONAL MONEY, YOU SHOULD READ VERY CAREFULLY ALL PAPERS YOU ARE REQUIRED TO SIGN, ASK SOMEONE ELSE, PREFERABLY AN ATTORNEY WHO IS NOT RELATED TO THE PERSON OFFERING TO HELP YOU, TO MAKE SURE THAT YOU UNDERSTAND WHAT YOU ARE SIGNING AND THAT YOU ARE NOT TRANSFERRING YOUR PROPERTY OR THE EQUITY IN YOUR PROPERTY WITHOUT THE PROPER INFORMATION. IF YOU CANNOT AFFORD TO PAY AN ATTORNEY, YOU MAY CONTACT THE COUNTY LEGAL AID OFFICE OF FLORIDA RURAL LEGAL SERVICES, 1500 NW AVENUE

"L" UNIT B, BELLE GLADE, FL 33430, PHONE: (888) 993-0003 TO SEE IF YOU QUALIFY FINANCIALLY FOR THEIR SERVICES. IF THEY CANNOT ASSIST YOU, THEY MAY BE ABLE TO REFER YOU TO A LOCAL BAR REFERRAL AGENCY OR SUGGEST OTHER OPTIONS. IF YOU CHOOSE TO CONTACT PALM BEACH COUNTY AID SERVICES FOR ASSISTANCE, YOU SHOULD DO SO AS SOON AS POSSIBLE AFTER RECEIPT OF THIS NOTICE.

16. The Court retains jurisdiction of this action to enter further orders as are proper including, without limitation, deficiency judgments.

**DONE AND ORDERED** in Chambers at the Palm Beach County Courthouse, West Palm

Beach, Florida on ~~04-17-2007~~ 1-29-2010.

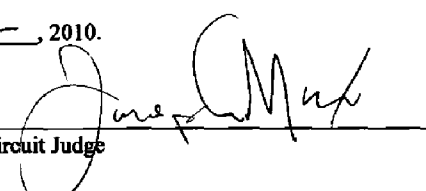
  
Circuit Judge

Copies furnished:

Gabrielle M Strauss, Esquire  
SMITH, HIATT & DIAZ, P.A.  
Attorneys for Plaintiff  
PO BOX 11438  
Fort Lauderdale, FL 33339-1438  
Telephone: (954) 564-0071

All parties on the attached service list  
1183-70318

**SERVICE LIST**

Case No. 502009CA027485XXMBAW

**JEAN BRUNER JEANGLAUE**

11 Hemming Dr  
Stafford, VA 22554

**GERTRUDE ARTHUR JEANGLAUE**

A/K/A GERTRUDE ARTHUR-JEANGLAUE  
11 Hemming Dr  
Stafford, VA 22554

**MICHAEL S. FELDMAN, ESQ**

Attorney For CANYON ISLES HOMEOWNERS ASSOCIATION, INC.  
6111 BROKEN SOUND PKWY NW, STE 200  
BOCA RATON, FL 33487

Unidentified copy



CFN 20100076403  
OR BK 23715 PG 1415  
RECORDED 03/01/2010 08:30:07  
Palm Beach County, Florida  
AMT 640,000.00  
Doc Stamp 4,480.00  
Sharon R. Bock, CLERK & COMPTROLLER  
Pgs 1415 - 1416; (2pgs)

This document was prepared by and Return to:  
MICHAEL A. TRINKLER, ESQ.  
MICHAEL A. TRINKLER, P.A.  
5501 University Drive, Suite 101  
Coral Springs, FL 33067  
Phone: (954) 753-5700  
Fax No. (954) 753-5767

TRIM COUNTY

(Reserved for Use by the Clerk)

**WARRANTY DEED**

THIS INDENTURE is made this 5 day of February, 2010, between, JEAN BRUNER JEANGLAUDE and GERTRUDE ARTHUR JEANGLAUDE, husband and wife, party of the first part, and ROMUALD ALTINE and GETOSE ALTINE, husband and wife, whose post office address is: 8671 Thornbrook Terrace Point, Boynton Beach, FL 33437, party of the second part.

**WITNESSETH:**

That the party of the first part, for and in consideration of the sum of TEN AND NO/100 (\$10.00) DOLLARS to them in hand paid by the party of the second part, the receipt whereof is hereby acknowledged, has granted, bargained and sold to the party of the second part, their heirs and assigns forever, the following described land, situate and being in the County of PALM BEACH and State of Florida, to-wit:

Lot 117, CANYON ISLES - PLAT TWO, according to the plat thereof, as recorded in Plat Book 105 at Page 40, of the Public Records of Palm Beach County, Florida.

Folio No.: 00-42-45-32-03-000-1170

**SUBJECT TO:**

1. Taxes for the year 2010, and subsequent years;
2. Conditions, restrictions, limitations and easements of record; without reimposing same;
3. Zoning restrictions, prohibitions and other requirements imposed by governmental authority.

And the party of the first part does hereby fully warrant the title to said land, and will defend the same against the lawful claims of all persons whomsoever.

(Reserved for Use by the Clerk)

IN WITNESS WHEREOF, the party of the first part has hereunto set her hand and seal the day and year first above written.

Signed, Sealed and Delivered  
In the Presence of:

*[Handwritten Signature]*

1<sup>st</sup> Witness Signature

Print Name of 1<sup>st</sup> Witness: Michelle D. Stearns

*Jean Bruner Jeanglaude*  
JEAN BRUNER JEANGLAUDE

*Dayna Solomey*

2<sup>nd</sup> Witness Signature

Print Name of 2<sup>nd</sup> Witness: Dayna Solomey

*Gertrude Arthur Jeanglaude*  
GERTRUDE ARTHUR JEANGLAUDE

Address: 11 Hemming Drive, Stafford, VA 22554

STATE OF Virginia )  
COUNTY OF Stafford ) SS:

The execution of the foregoing instrument was acknowledged before me this 5 day of February, 2010 by, JEAN BRUNER JEANGLAUDE and GERTRUDE ARTHUR JEANGLAUDE, who are personally known to me or who have produced VA drivers license as identification, and who did not take an oath.

My Commission Expires: 6/30/10

*Karen Barrons*

Notary Public

Print Name: Karen Barrons

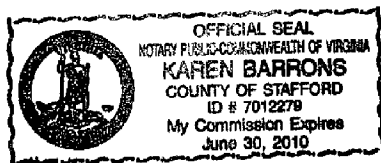



Document Prepared By:  
ReconTrust Company, N.A.  
2575 W. Chandler Blvd.  
Mail Stop: AZ1-804-02-11  
Chandler, AZ 85224  
(800) 540-2694

CFN 20100187212  
OR BK 23857 PG 0153  
RECORDED 05/20/2010 09:34:28  
Palm Beach County, Florida  
Sharon R. Bock, CLERK & COMPTROLLER  
Pg 0153; (1pg)

When recorded return to:  
JEAN BRUNER JEANGLAUE  
11 Hemming Dr.  
Stafford  
VA 22554

DOC ID#0001659709342005N

**SATISFACTION OF MORTGAGE**

KNOW ALL MEN BY THESE PRESENTS: Mortgage Electronic Registration Systems, Inc. the owner and holder of a certain mortgage deed executed by JEAN BRUNER JEANGLAUE AND GERTRUDE ARTHUR-JEANGLAUE to Mortgage Electronic Registration Systems, Inc. bearing date 03/30/2007, recorded on 04/19/2007 in Official Records Book OR 21639, Page 1219, Instrument # 20070188785 in the office of the Clerk of the Circuit Court of PALM BEACH County State of Florida, securing a certain note in the principal sum of \$607,000.00 Dollars, and certain promises and obligations set forth in said mortgage deed, upon the property situated in said State and County hereby acknowledge full payment and satisfaction of said note and mortgage deed, and surrenders the same as canceled, and hereby directs the Clerk of the said Circuit Court to cancel the same of record.

(CORPORATE SEAL)

IN WITNESS WHEREOF the said Corporation has caused these presents to be executed in its name, and its corporate seal to be hereunto affixed, by its proper officers thereunto duly authorized, the 9 day of May, 2010.

Mortgage Electronic Registration Systems, Inc.

ATTEST:  
[Signature]  
DeWayne Vardaman  
Assistant Secretary

Signed and delivered in the presence of:

[Signature]  
Amy DeLaPaz  
Witness

By [Signature]  
Icela Lopez  
Vice President

STATE OF ARIZONA  
COUNTY OF MARICOPA

On 5-4-10 before me, Edward Napier, Notary Public, personally appeared Icela Lopez personally known to me (or proved to me on the basis of satisfactory evidence) to be the person whose name is subscribed to the within instrument and acknowledged to me that he/she executed the same in his/her authorized capacity, and that by his/her signature on the instrument the person, or the entity upon behalf of which the person acted, executed the instrument.

Witness my hand and official seal.

[Signature]  
Edward Napier, Notary Public  
Expires: 09/14/2013

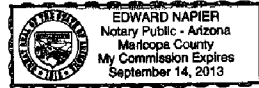

1                    **Exhibit 5 - UCAV Distributed Mission Training Testbed:**

2                    **Lessons Learned and Future Challenges**

3                    by Dr. Dutch Guckenberger and Matt Archer

4                    The Interservice/Industry Training, Simulation & Education Conference

5                    (I/ITSEC), Volume: 2000 (Conference Theme: Partnerships for Learning in

6                    the New Millennium)

7                    <http://ntsa.metapress.com/link.asp?id=4mrrc0aupmjpf8e6>

8



[Log out genevahunter](#)

- [Home](#)
- [About](#)
- [Search](#)
- [Volumes](#)
- [Account](#)
- [Subscribe](#)
- [Shopping Cart](#)
- [Order History](#)
- [Profile](#)
- [Services](#)
- [Alerting](#)
- [ActiveSearch](#)
- [Support](#)
- [Contact Us](#)
- [Downloads](#)

Article

[Back To: Search Results](#)



[The Interservice/Industry Training, Simulation & Education Conference \(IITSEC\)](#)

**Volume:** 2000 (Conference Theme: Partnerships for Learning in the New Millennium)

**URL:** [Linking Options](#)

**UCAV Distributed Mission Training Testbed: Lessons Learned and Future Challenges**

Dr. Dutch Guckenberger<sup>A1</sup> and Matt Archer<sup>A1</sup>

<sup>A1</sup> SDS International Inc., Orlando, FL

<sup>A2</sup> BMH Associates, Inc., Norfolk, VA

**Abstract:**

The UCAV DMT Testbed research will focus on technologies for: defining effective training strategies for UAV/UCAV operators; assessing the delta in training required for multiple vehicles; advanced displays driven from human factors design; integration of Geneva Aerospace's Variable Autonomy Control System; and integrating several UAV and UCAV Flight Model into the Testbed. Potential applications include direct linkage of UCAV Testbeds as Participants in DMT. This paper chronicles the development of the UCAV DMT Testbed from the perspective of lessons learned and details features planned to support the initial research efforts planned for 2000.

Four successful UCAV DMT demonstrations and experiments are presented from a lessons learned perspective. Starting with the initial separately developed PC-Based UCAV simulations; evolving to the merging of the simulations and initial DMT research experiments including DMTO&I testbed, IITSEC99 and planned AFRL Mesa UCAV DMT Demonstrations. Key testbed components included the LiteFlite Flight Simulator, JSAF and SOAR applications, and the Variable Autonomy Control System (VACS). The unique and innovative portions of this paper detail the components integration for UCAV missions and operational concepts, along with the human factors engineering on the VACS human-system interface design and LiteFlite researcher toolkit interfaces. Illustrative examples, are also included with sufficient details to support other government, industry and academic organizations participation in future UCAV DMT experiments and demonstrations.

Participating organizations include but are not limited to AFRL Mesa, SDS International, Geneva Aerospace, Eglin 46<sup>th</sup> Test Wing PRIMES, NASA Dryden Flight Research Center/Tuskegee University, Computer Science Corporation. Future participants may include Navy Pax River (MFS and Distributed Simulation Groups), AFRL Wright-Patterson and Naval Aerospace Medical Research Lab. Additional discussion includes related UCAV DMT Research topics of :

- LiteFlite UCAV and Testbed Utilization of the Ordnance Server to ensure DMT Fair Fight
- Innovations associated with a new Distributed Ordnance Server to insure Temporal Correlation of the
- Target/Counter-Measure/Weapon Triad

**Full Text Access**

**Full Text Available**

The full text of this article is available. You may view the article as (a):

PDF

The size of this document is 2,135 kilobytes. Although it may be a lengthier download, this is the most authoritative online format.

[Open Full Text](#)

HTML

This offers the quickest access for ease of browsing. Please note that some scientific and mathematical characters may not render as precisely as in PDF versions.

[Open Full Text](#)



• An Innovative new concept of handing off UCAV Ownership from the Virtual LiteFlite Host Simulation to

the Constructive JSAF and SOAR Agents to automate tasks for the UCAV operators Results from three initial UCAV integration efforts are presented detailing DIS integration with existing DMT assets and HLA integration with planned DMT configurations I/TSEC99, USAF Only DMTO&I Demonstration Jan2000, DMT UCAV Testbed development for AFRL/HEA and UAV 2000 Demonstration July 2000. An outline of planned research efforts that will utilize the DMT UCAV Testbed are presented along with Future Research Directions.

---



Remote Address: 68.190.187.74 • Server: MPWEB03  
HTTP User Agent: Mozilla/5.0 (Windows; U; Windows NT 6.0; en-US; rv:1.9.2.3) Gecko/20100401  
Firefox/3.6.3 (.NET CLR 3.5.30729)

## UCAV Distributed Mission Training Testbed: Lessons Learned and Future Challenges

**Dr. Dutch Guckenberger & Matt Archer**  
SDS International Inc.  
Orlando, FL  
[dutchg@sdslink.com](mailto:dutchg@sdslink.com) & [marcher@sdslink.com](mailto:marcher@sdslink.com)

**Michael R. Oakes**  
BMH Associates, Inc.  
Norfolk, VA  
[moakes@bmh.com](mailto:moakes@bmh.com)

### Abstract

The UCAV DMT Testbed research will focus on technologies for: defining effective training strategies for UAV/UCAV operators; assessing the delta in training required for multiple vehicles; advanced displays driven from human factors design; integration of Geneva Aerospace's Variable Autonomy Control System; and integrating several UAV and UCAV Flight Model into the Testbed. Potential applications include direct linkage of UCAV Testbeds as Participants in DMT. This paper chronicles the development of the UCAV DMT Testbed from the perspective of lessons learned and details features planned to support the initial research efforts planned for 2000.

Four successful UCAV DMT demonstrations and experiments are presented from a lessons learned perspective. Starting with the initial separately developed PC-Based UCAV simulations; evolving to the merging of the simulations and initial DMT research experiments including DMTO&I testbed, I/ITSEC99 and planned AFRL Mesa UCAV DMT Demonstrations. Key testbed components included the LiteFlite Flight Simulator, JSAF and SOAR applications, and the Variable Autonomy Control System (VACS). The unique and innovative portions of this paper detail the components integration for UCAV missions and operational concepts, along with the human factors engineering on the VACS human-system interface design and LiteFlite researcher toolkit interfaces. Illustrative examples, are also included with sufficient details to support other government, industry and academic organizations participation in future UCAV DMT experiments and demonstrations.

Participating organizations include but are not limited to AFRL Mesa, SDS International, Geneva Aerospace, Eglin 46<sup>th</sup> Test Wing PRIMES, NASA Dryden Flight Research Center/Tuskegee University, Computer Science Corporation. Future participants may include Navy Pax River (MFS and Distributed Simulation Groups), AFRL Wright-Patterson and Naval Aerospace Medical Research Lab. Additional discussion includes related UCAV DMT Research topics of:

- LiteFlite UCAV and Testbed Utilization of the Ordnance Server to ensure DMT Fair Fight
- Innovations associated with a new Distributed Ordnance Server to insure Temporal Correlation of the Target/Counter-Measure/Weapon Triad
- An Innovative new concept of handing off UCAV Ownership from the Virtual LiteFlite Host Simulation to the Constructive JSAF and SOAR Agents to automate tasks for the UCAV operators

Results from three initial UCAV integration efforts are presented detailing DIS integration with existing DMT assets and HLA integration with planned DMT configurations I/ITSEC99, USAF Only DMTO&I Demonstration Jan2000, DMT UCAV Testbed development for AFRL/HEA and UAV 2000 Demonstration July 2000. An outline of planned research efforts that will utilize the DMT UCAV Testbed are presented along with Future Research Directions.

### About the Authors

**Dr. Dutch Guckenberger** is the Chief Scientist at SDS International, with 15 years of experience in the defense simulation and training systems. He has earned degrees in Computer Science, Physics, & Simulation and Training. Research interests include Distributed Mission Training, High Resolution PC-Based Visual Systems, Above Real-Time Training (ARTT), UAV and UCAV Research. He is a member of ACM, IEEE, Human Factors Society & a Link Foundation Fellow in Advanced Simulation & Training.

**Michael Oakes** is a Sr. Systems Engineer with BMH Associates, Inc. He was responsible for the evolution and deployment of high priority classified special access required programs. He is a retired USAF fighter pilot with over 20 years of experience in the Pacific, European, and Southwest Asia theaters of operations and is a USAF F-15 Fighter Weapons School Graduate. Mr. Oakes was the WISSARD Lab Test Director for the STOW-97 ACTD. He continues to provide modeling and military domain expertise for Air Synthetic Force development used in JSAF technologies.

1

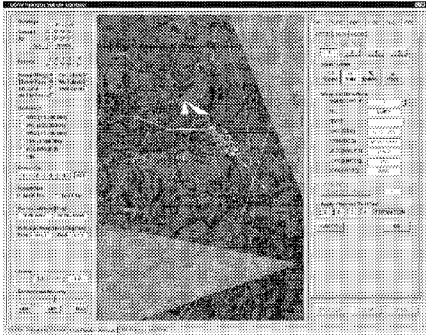

**Figure 11.** LiteLite UCAV Situational/ MFD Display replicate based upon the original interface developed by WPAFB Operator Vehicle Interface Lab.

It is important to note that the LiteLite image above was developed based upon JPEG images from AFRL/HECP Operator Vehicle Interface (OVI) Group. The key to economically supporting the UCAV researchers is effective rapid prototyping. To this end SDS with their DISTI team partner were able to develop the Situational Display and the major portions of the Multifunction Display to functional prototype level including the DIS connectivity in less than 120 Hours. (See figure 11 above for the prototype UCAV Multifunction Display.)

#### Variable Autonomy Control System (VACS)

As a portion of the DMT UCAV Testbed development, the Geneva AeroSpace Variable Autonomy Control System (VACS) was added to LiteLite. The VACS is designed to be effective for UAV and UCAV systems as usable to individuals whose training is focused on the requirements of a given mission or the usability of the payload, rather than on the aviation of the vehicle. As the dependence on UAVs for military operations grows and UAV technology is integrated into the emerging global command and control architecture, the cost and complexity of managing and controlling these assets can easily become substantial. The VACS solution to this UAV control problem lies in the appropriate functional allocation between the human and the machine. By merging modern stand-off missile flight control, advanced aircraft flight control, and state-of-the-art communications technologies, Geneva has developed a novel hierarchical flight control structure with varied levels of remote operator input to address the human-machine functional allocation problem.

The VACS has been successfully demonstrated enabling a diverse range of users to effectively operate UAVs. Furthermore, the VACS solution eliminates the requirement for UAVs to be controlled by highly

trained, rated pilots. In a continuing development and demonstration effort VACS is to be used Joint STARS MTE workstation and the Freewing Scorpion 100-50 UAV and conduct a flight test demonstration. This program will demonstrate the benefits of the variable autonomy flight control system design with simplified manual control modes, demonstrate the compatibility of such a system with the military's emerging C<sup>4</sup>I architecture, and demonstrate the synergism between Joint STARS and UAVs using the simplified UAV flight control technology.

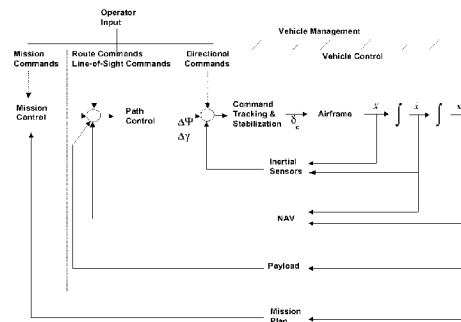

**Figure 12.** Variable Autonomy Control System (VACS)

#### JSAF, SOAR & SOAR Speak

Current distributive training technology has evolved towards larger Federations and greater entity resolution. DARPA's STOW has been the only demonstrated large-scale High Level Architecture (HLA) simulation using both large aggregates (for visualization) and entity resolution (for interaction arbitration). Since the October 1997 DoD Advanced Concept Technology Demonstration (ACTD) milestone, STOW has evolved to a viable technology demonstrating high resolution (platform level) simulation to support joint command and staff training, mission visualization capabilities and unit level training. STOW's ability for entity-level resolution has made it an excellent candidate for the USAF Distributed Mission Training (DMT) Program. The STOW Program has evolved into the Joint Semi Autonomous Forces (JSAF) and increased its applications to provide a robust simulation capable of supporting operational training, testing new concepts and doctrine as well as service and joint experimentation issues with direct linkages to real-world C<sup>4</sup>ISR systems in a seamless live, virtual or constructive environment. The current JSAF sponsor is the United States Joint Forces Command (USJFCOM).

1

2

**Exhibit 6** - Documents from Geneva Aerospace Trademark Application,

3

Serial Number 78355947 for “Variable Autonomy Control System”

4

From USPTO Trademark Document Retrieval (TDR) Web Site

5

<http://tmportal.uspto.gov/external/portal/tow>

6

**Trademark/Service Mark Application, Principal Register**

**Serial Number: 78355947**

**Filing Date: 01/22/2004**

**To the Commissioner for Trademarks:**

**MARK:** (Standard Characters, see mark)

The mark consists of standard characters, without claim to any particular font, style, size, or color.

The literal element of the mark consists of VARIABLE AUTONOMY CONTROL SYSTEM.

The applicant, Geneva Aerospace, Inc., a corporation of Texas, residing at 4312 Sunbelt Dr., Addison, TX, USA, 75001, requests registration of the trademark/service mark identified above in the United States Patent and Trademark Office on the Principal Register established by the Act of July 5, 1946 (15 U.S.C. Section 1051 et seq.), as amended.

The applicant, or the applicant's related company or licensee, is using the mark in commerce, and lists below the dates of use by the applicant, or the applicant's related company, licensee, or predecessor in interest, of the mark on or in connection with the identified goods and/or services. 15 U.S.C. Section 1051(a), as amended.

International Class 009: computer software for autonomous aerial vehicle guidance and control systems

In International Class 009, the mark was first used at least as early as 09/01/1998, and first used in commerce at least as early as 09/01/1998, and is now in use in such commerce. The applicant is submitting or will submit one specimen for *each class* showing the mark as used in commerce on or in connection with any item in the class of listed goods and/or services, consisting of a(n) Portion of company website describing product.

Specimen - 1

The applicant hereby appoints Alexander M. Parker and R. Steven Jones of Jones & Davis, L.L.P., 15851 Dallas Parkway Suite 1220, Addison, TX, USA, 75001 to submit this application on behalf of the applicant. The attorney docket/reference number is Geneva/TM.

The USPTO is authorized to communicate with the applicant or its representative at the following email address: aparker@jonesdavis-law.com.

A fee payment in the amount of \$335 will be submitted with the application, representing payment for 1 class(es).

**Declaration**

The undersigned, being hereby warned that willful false statements and the like so made are punishable by

1

fine or imprisonment, or both, under 18 U.S.C. Section 1001, and that such willful false statements, and the like, may jeopardize the validity of the application or any resulting registration, declares that he/she is properly authorized to execute this application on behalf of the applicant; he/she believes the applicant to be the owner of the trademark/service mark sought to be registered, or, if the application is being filed under 15 U.S.C. Section 1051(b), he/she believes applicant to be entitled to use such mark in commerce; to the best of his/her knowledge and belief no other person, firm, corporation, or association has the right to use the mark in commerce, either in the identical form thereof or in such near resemblance thereto as to be likely, when used on or in connection with the goods/services of such other person, to cause confusion, or to cause mistake, or to deceive; and that all statements made of his/her own knowledge are true; and that all statements made on information and belief are believed to be true.

Signature: /alexander\_parker/    Date: 01/22/2004  
Signatory's Name: Alexander M. Parker  
Signatory's Position: Attorney

Mailing Address:  
Alexander M. Parker  
15851 Dallas Parkway Suite 1220  
Addison, TX 75001

RAM Sale Number: 513  
RAM Accounting Date: 01/23/2004

Serial Number: 78355947  
Internet Transmission Date: Thu Jan 22 18:04:09 EST 2004  
TEAS Stamp: USPTO/BAS-6419013490-2004012218040973155  
8-78355947-20044c21f938bb7a26d3b3c87a1dc  
5be85-CC-513-20040122180300429827

2

# VARIABLE AUTONOMY CONTROL SYSTEM

1

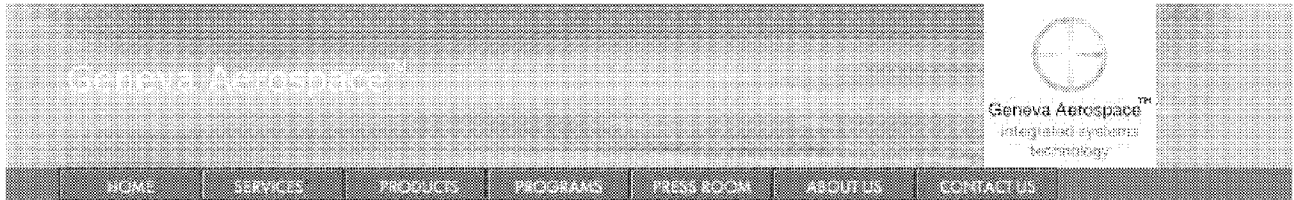

Dakota Unmanned-Aerial Vehicle

Variable Autonomy Control System (VACS)

Low-Cost UAV Avionics Kit

Hi-Fidelity 6DOF Engineering Simulation

400 MHz UAV Flight Termination System

Multi-UAV IP DataLink System

### Products: Variable Autonomy Control System (VACS)™

Under Air Force Research Lab funding, Geneva has developed an innovative UAV control design that combines state-of-the-art missile technologies with fixed-wing aircraft control. Our design balances autonomous flight control with manual control to provide variable levels of directional independence and minimizes the personnel and training requirements for the operation of the UAV. The truly enabled UAV operator is not required to be a trained aviator, but still retains a wide range of control flexibility in order to successfully execute the mission objectives that call upon his/her specialized expertise.

Our solution is a hierarchical flight control structure with multiple levels of remote operator input combined with an off-board controller software package and intuitive human system interface. Research of the UAV control problem has indicated that the best solution lies in the appropriate functional allocation between the human and the machine, leading to the organization of the control problem between the two fundamental categories: flight governance and flight management.

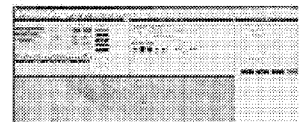
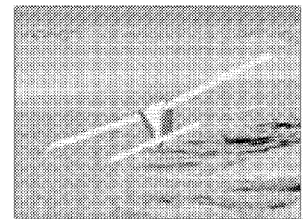
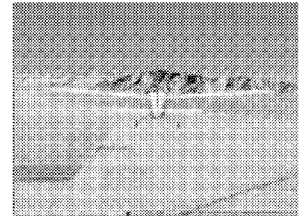

2

3



1            **Exhibit 7** - Documents from Geneva Aerospace Trademark Application,  
2            Serial Number 78355939 for “VACS” From USPTO Trademark Document  
3            Retrieval Web Site <http://tmportal.uspto.gov/external/portal/tow>

4  
5

**Serial Number: 78355939**

**Filing Date: 01/22/2004**

**To the Commissioner for Trademarks:**

**MARK:** (Standard Characters, see mark)

The mark consists of standard characters, without claim to any particular font, style, size, or color.

The literal element of the mark consists of VACS.

The applicant, Geneva Aerospace, Inc., a corporation of Texas, residing at 4312 Sunbelt Dr., Addison, TX, USA, 75001, requests registration of the trademark/service mark identified above in the United States Patent and Trademark Office on the Principal Register established by the Act of July 5, 1946 (15 U.S.C. Section 1051 et seq.), as amended.

The applicant, or the applicant's related company or licensee, is using the mark in commerce, and lists below the dates of use by the applicant, or the applicant's related company, licensee, or predecessor in interest, of the mark on or in connection with the identified goods and/or services. 15 U.S.C. Section 1051(a), as amended.

International Class 009: computer software for autonomous aerial vehicle guidance and control systems

In International Class 009, the mark was first used at least as early as 09/01/1998, and first used in commerce at least as early as 09/01/1998, and is now in use in such commerce. The applicant is submitting or will submit one specimen for *each class* showing the mark as used in commerce on or in connection with any item in the class of listed goods and/or services, consisting of a(n) Portion of company website describing product.

Specimen - 1

The applicant hereby appoints Alexander M. Parker and R. Steven Jones of Jones & Davis, L.L.P., 15851 Dallas Parkway Suite 1220, Addison, TX, USA, 75001 to submit this application on behalf of the applicant. The attorney docket/reference number is Geneva/TM.

The USPTO is authorized to communicate with the applicant or its representative at the following email address: aparker@jonesdavis-law.com.

A fee payment in the amount of \$335 will be submitted with the application, representing payment for 1 class(es).

**Declaration**

The undersigned, being hereby warned that willful false statements and the like so made are punishable by fine or imprisonment, or both, under 18 U.S.C. Section 1001, and that such willful false statements, and the like, may jeopardize the validity of the application or any resulting registration, declares that he/she is properly authorized to execute this application on behalf of the applicant; he/she believes the applicant to

1

be the owner of the trademark/service mark sought to be registered, or, if the application is being filed under 15 U.S.C. Section 1051(b), he/she believes applicant to be entitled to use such mark in commerce; to the best of his/her knowledge and belief no other person, firm, corporation, or association has the right to use the mark in commerce, either in the identical form thereof or in such near resemblance thereto as to be likely, when used on or in connection with the goods/services of such other person, to cause confusion, or to cause mistake, or to deceive; and that all statements made of his/her own knowledge are true; and that all statements made on information and belief are believed to be true.

Signature: /alexander\_parker/    Date: 01/22/2004  
Signatory's Name: Alexander M. Parker  
Signatory's Position: Attorney

Mailing Address:  
Alexander M. Parker  
15851 Dallas Parkway Suite 1220  
Addison, TX 75001

RAM Sale Number: 498  
RAM Accounting Date: 01/23/2004

Serial Number: 78355939  
Internet Transmission Date: Thu Jan 22 17:58:51 EST 2004  
TEAS Stamp: USPTO/BAS-6419013490-2004012217585161254  
8-78355939-200bbdc8f49b5e5748ffb87cf9e3f  
98ff55-CC-498-20040122175614433791

2

VACS

1

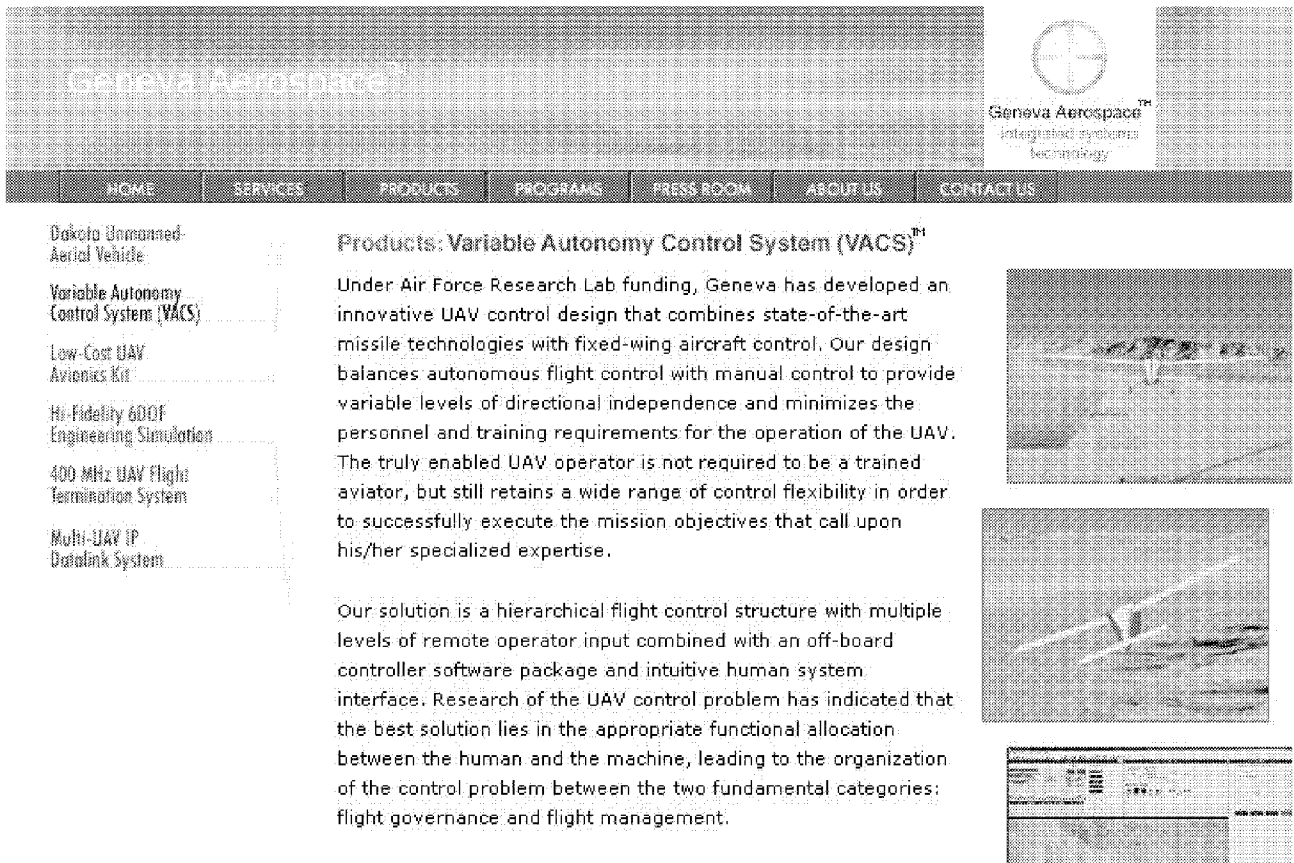

The screenshot shows the Geneva Aerospace website. At the top left is the company name "Geneva Aerospace™". To the right is a logo featuring a crosshair and the text "Geneva Aerospace™ integrated systems technology". Below this is a navigation menu with links for HOME, SERVICES, PRODUCTS, PROGRAMS, PRESS ROOM, ABOUT US, and CONTACT US.

On the left side, there is a vertical list of product links: Dakota Unmanned Aerial Vehicle, Variable Autonomy Control System (VACS), Low-Cost UAV Avionics Kit, Hi-Fidelity 6DOF Engineering Simulation, 400 MHz UAV Flight Termination System, and Multi-UAV IP Datalink System.

The main content area features the heading "Products: Variable Autonomy Control System (VACS)™". Below this is a paragraph: "Under Air Force Research Lab funding, Geneva has developed an innovative UAV control design that combines state-of-the-art missile technologies with fixed-wing aircraft control. Our design balances autonomous flight control with manual control to provide variable levels of directional independence and minimizes the personnel and training requirements for the operation of the UAV. The truly enabled UAV operator is not required to be a trained aviator, but still retains a wide range of control flexibility in order to successfully execute the mission objectives that call upon his/her specialized expertise."

Below the paragraph is another paragraph: "Our solution is a hierarchical flight control structure with multiple levels of remote operator input combined with an off-board controller software package and intuitive human system interface. Research of the UAV control problem has indicated that the best solution lies in the appropriate functional allocation between the human and the machine, leading to the organization of the control problem between the two fundamental categories: flight governance and flight management."

On the right side, there are three images: a top-down view of a fixed-wing aircraft, a side view of a fixed-wing aircraft in flight, and a screenshot of a computer interface with various data fields and graphs.

2

1  
2  
3  
4  
5

**Exhibit 8 - Development and Testing of a Variable Autonomy  
Control System (VACS) for UAVs**, by Dave Duggan of Geneva  
Aerospace and Luis A. Piñeiro of AFRL contained in the  
Proceedings AUVSI Symposium, 2002

## Development and Testing of a Variable Autonomy Control System (VACS) for UAVs

Dave Duggan  
Vice President and Program Manager  
Geneva Aerospace  
4318 Sunbelt Dr.  
Addison, TX 75001  
(214) 420-2376 X105  
[dduggan@genaero.com](mailto:dduggan@genaero.com)

Luis A. Piñeiro  
Air Force Program Manager  
Air Force Research Laboratory  
Integration and Demonstration Branch  
AFRL/VAAI  
2130 8<sup>th</sup> St. STE 1  
WPAFB OH 45433-7542  
(937) 255-2857  
[Luis.Pineiro@wpafb.af.mil](mailto:Luis.Pineiro@wpafb.af.mil)

### Abstract

As the role of UAVs expands throughout the DOD, increased consideration must be given to reduce cost and complexity of managing and controlling UAVs. First generation control schemes focus on either manual control (remote pilot-in-the-loop) or fully autonomous (pre-programmed) control. These schemes impose significant personnel and training requirements on one side, or increased logistics (mission planning and asset allocation) on the other. The objective of the Variable Autonomy Control System™ (VACS) program is to improve real-time control capability for UAVs by allowing autonomous route following capability (as it exists in current Air Force UAV systems) while providing for dynamic real-time control to deviate from pre-planned routes to accomplish a wide variety of tasks; and reduce human workload requirements significantly below that of existing UAV systems, thus allowing a single operator to effectively manage and control multiple UAVs as opposed to multiple operators per single UAV. The VACS architecture

provides for varying levels of control autonomy, from fully autonomous control to simplified manual flight control modes, and provides a flexible and simple user interface with a much smaller logistical footprint. Furthermore, the VACS design facilitates manned and unmanned systems interoperability as will be demonstrated in follow-on initiatives.

This paper describes the approach to the system's architecture and design, as well as the testing accomplished to date to validate its capabilities. The effectiveness of the system was evaluated recently in a series of flight demonstrations.

### Background

Although first generation military UAVs have an impressive set of capabilities, real-time control capability may have been somewhat limited by the need to pre-program routes for totally automated platforms, or the need to have rated pilots assigned in non-flying tours of duty to deal with manually controlled assets. Rarely,

however, do real-world missions go exactly as planned. There are time-critical targets that pop up; traffic conflicts with manned aircraft; clouds that get in the way of EO/IR sensors; and, intelligent and devious adversaries who make target location and identification difficult. Real-time control is required to deviate from the planned route to find and identify new targets; to maneuver UAVs to avoid traffic; to fly under the weather; and to get better line-of-sight angles. Skilled pilots can maneuver aircraft, but then an additional operator is necessary to manage the sensors and the dynamic mission. Likewise, as the dependence on UAVs for military operations grows and UAV technology is integrated into the emerging global command and control architecture, the cost and complexity of managing and controlling these assets are expected to become substantial. Hence, an integrated flight control/flight management system that allows for, but minimizes, human intervention is necessary for the Joint Services.

The VACS effort was established with the purpose of addressing the aforementioned concerns, thus simplifying UAV operation and control. As its name suggests, the architecture includes varying levels of control autonomy from fully autonomous control to simplified manual flight control modes. The simplified manual modes are designed to address Air Combat Command's stated need for "improved real-time control of UAVs". Along with the need for improved real-time control capabilities,

efforts exist within the Air Force to investigate the benefits of placing the UAV control onboard an aircraft. Doing this would allow a Joint STARS to capture imagery for positive ID of ground targets detected by radar. AWACS controllers could direct UAVs to jam enemy radar (when EA-6B Prowlers are unavailable) or direct UCAVs to attack radar sites. Rivet Joint controllers could maneuver UAVs to gather electronic intelligence. AC-130 gunship crews could maneuver a UAV below the clouds to identify targets and assess damage from a safe distance. These airborne platforms, however, have limited space on board for a crew dedicated to UAV control, and need a "de-skilled" UAV control system for their existing operators to use.

#### **VACS Overview**

The VACS architecture is designed to support an emerging generation of autonomous and semi-autonomous air vehicles. The design provides seamless transition between varying levels of control autonomy from fully autonomous control to simplified manual flight control modes. The VACS design evolved from high-performance aircraft and advanced standoff missile flight control technologies. Funding for the variable autonomy control concept was provided under the Small Business Innovative Research (SBIR) program Phase I, Phase II, and Phase III funding vehicles through the Air Force Research Laboratory (AFRL) Human Effectiveness and Air Vehicles Integration Directorates (Reference



1). The VACS is to improve real-time control of UAVs, providing autonomous route following capability (as exists in current Air Force UAV systems) while allowing for dynamic real-time control to:

- Deviate from the planned route
- Find and identify new targets
- Maneuver UAVs to avoid traffic
- Fly under the weather
- Avoid terrain collision and support low altitude terrain following
- Avoid airborne collisions with other manned and unmanned air vehicles
- Get better line-of-sight angles for target identification, bomb damage assessment, and other intelligence gathering missions

The VACS provides the real-time control capability that a flexible, operational UAV system requires to successfully execute a mission, including dynamic sensor control and real-time re-tasking, with human workload requirements significantly below that of existing UAV systems. Currently, the VACS capabilities include:

- Autonomous route navigation with autonomous on-station orbit and target search capabilities
- Real-time route editing
- Mixed/hybrid UAV control, such as execution of programmed, energy efficient

climb to operator selected altitude mixed with autopilot assisted manual turn capability

- Tight integration of the UAV primary imaging sensor with the outer control loop for automatic sensor slave steering
- Simplified manual control allowing for real-time manual directional control capability (horizontal and vertical) with no operator training or aviation experience required
- Photo-realistic synthetic vision display (SVD) technology supporting synthetically enhanced situation awareness for the UAV operator

Additional capabilities currently being *implemented* are:

- Automatic takeoff and landing with no requirement for external aiding/guidance sensors
- Multi-ship control capability allowing a single operator the capability to simultaneously manage and control four or more UAVs at one time
- Digital terrain elevation database (DTED) based automatic ground collision avoidance
- Optical sensor based autonomous air collision avoidance

Each of these technologies is being implemented and flight-tested through multiple Air Force and Navy Autonomous Operations research and development programs that extend through the

summer of FY2003. The significant UAV capability advancements offered by the VACS design are the culmination of leveraging advanced capabilities developed through several Army, Navy, and Air Force programs.

VACS was designed to offer a core autonomous and semi-autonomous air vehicle flight control and multi-modal management software package that facilitates rapid, affordable advancements in UAV automation while maintaining seamless integration of the operator and the UAV(s) at all levels of control automation. Reviewing a structure for generalized intelligent control architecture provides a method of relating the VACS design to such a core software package. Figure 1 shows the mapping between a generalized intelligent controller hierarchy and the VACS architecture. The VACS design is modular and generic in nature. Hence, adaptation of VACS in its entirety or of one or several subcomponents thereof to TCS, VTUAV, TUAV, and other future military UAV systems will be technically trivial and can be done with rapid turn-around for low cost. Geneva is currently engaged in several proprietary programs in which VACS adaptations are under way.

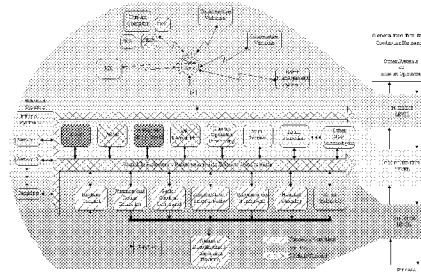

Figure 1 VACS Architecture

A key point to note in the above figure is that the core system architecture, core guidance, navigation, and control algorithms, and major sub-system interfaces are in place. New modules (i.e., new autonomous operations technologies) are added as funding permits. For example, the current AFRL 6.2 program is adding an automatic ground collision system (AutoGCAS, Reference 2). Additionally, an ONR funded Autonomous Operations program is adding an optical sensor-based autonomous “see and avoid” system. Capabilities such as these are modules that “plug” into the core architecture as facilitated by the modular “plug-n-play” design of the VACS system.

The VACS architecture is comprised of airborne management and control functions as well as off-board control interfaces and intuitive human-system interfaces. The off-board control station is comprised of faster-than-real-time simulation capability supporting real-time operator situation awareness and decision aids, intuitive graphical user interfaces and situation displays, and

advanced photo-realistic synthetic vision displays.

The combination of high fidelity synthetic visualization tools (offered by Geneva's industry partner – SDS International), faster than real time simulation technology, and variable autonomy control provides a baseline architecture that is capable of supporting a new level of real-time UAV control and situation awareness. The synthetically enhanced situation awareness system (SESAS) supports real-time management and control of multiple UAVs by a single operator. The synthetic visualization display includes threat data realistically displayed over mapped and photo-realistic 3D terrain. These visuals are driven (dynamically propagated) by a combination of simulated and real UAV data. The simulated data is generated by the ground control station and propagated at a much higher rate than real data is received from the air vehicle. When real data is received, it is used to correct the simulation solution, thus providing an accurate, continuous representation of the UAV flight state within its environment.

The realism afforded by the synthetic visuals significantly enhances the operator's situation awareness. The synthetic visuals offer multiple views (or frames of reference) and increased field-of-view (FOV) over that of on-board sensors. Figure 2 illustrates the concept.

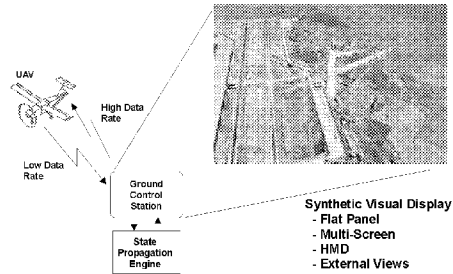

Figure 2 Synthetically Enhanced Situation Awareness Concept

The Synthetically Enhanced Situation Awareness technology can be utilized to provide a wide FOV that augments live video and sensor feeds while *circumventing payload and bandwidth limitations*. Specifically, correlated, photo-realistic 3D terrain can be presented on multiple monitors or flat panel displays to provide a wide area FOV and aid controllers in orientation and situation awareness. Furthermore, this photo-realistic representation of the scene can be viewed from various frames of reference with the simple push of a button.

The synthetic vision based enhanced situation awareness concept was recently demonstrated in a flight test conducted over the Army's 10<sup>th</sup> Mountain Division Ft. Drum training range located in upstate New York. VIPs in attendance noted the realism of the synthetic visuals with respect to the live video feed transmitted from the UAV.

Significant reductions in datalink bandwidth requirements can be achieved with the aid of the simulation. Background and high frequency update information is provided by the simulation, while low-frequency data specific to the UAV – data that changes in real time over long periods of time – is provided via downlinks. By filling in the high frequency gaps with simulated data, very low update rates over the datalink are made feasible in that the operator is provided with a continuous situation awareness that is comprised of mixed live and simulated data. SESAS addresses two key areas of needed technology improvements in the UAV community: datalink bandwidth and survivability. By significantly reducing the transmission requirements of the air vehicle, UAV detection becomes more difficult, thus increasing system survivability.

#### **VACS Control Modes**

The VACS is designed using a flight control architecture that is predominant in the missile industry. The autopilot software design utilizes state-of-the-art flight control techniques, which allow the actuators to dynamically adjust the airframe stabilization properties “on the fly”. The flight computer is programmed directly with the airframe physical properties, so that it can automatically adjust its settings with changes in airframe configuration, aerodynamic properties, or flight state. This provides for a simple and

versatile design, and possesses the critical flexibility needed when adjustments to the airframe configuration become necessary during the course of the program.

The guidance executive manages path regulation and operator inputs and selects the appropriate guidance law to achieve the desired control requirement, supporting varying levels of control from fully autonomous waypoint / route following to fully manual directional control steering. All of the control capability requirements needed to support management and control of multiple UAVs by a single operator are comprehended in the existing VACS design and have been flight proven on Geneva’s Dakota UAV testbed.

The distinguishing aspect of the design is the fluidity with which control levels are transitioned. Through algorithm research and human factors engineering trials, we derived a *trajectory synthesis* based control scheme. This control scheme uses trajectory predictive techniques that allow the operator to effortlessly interact with the control system at any control level from manual through autonomous. The marvel of the control scheme selected, which was derived primarily from advanced missile controls concepts, is its effectiveness in achieving the performance objectives with an uncomplicated, yet advanced, algorithm implementation.

The design is founded on rigorous, tractable mathematical formulations that allow interaction with the operator inputs and allow the operator to instantaneously remove himself from the loop without concern over corresponding vehicle reactions – the vehicle does what the pilot expects. We avoid, however, heuristic techniques (neural networks, artificial intelligence, fuzzy controllers), as they are not needed at this level of control. These techniques will be employed at the observer level for subsystem fault detection in future intelligent autonomy efforts. Consequently, the control system design is robust, predictable, and verifiable. From the UAV perspective, the vehicle that is sent out is the exact same vehicle that returns – a crucial design tenant that allows us to verify safe and predictable performance.

Although human factors played a key role in the design evolution, equally important were robustness, reliability, and affordability. The design features a tolerance to inertial sensor errors and large system latencies. A COTS-based design approach utilizing micro electromechanical systems (MEMS) sensors and commercial grade components was a primary objective in our research. Consequently, the control system design had to provide precision control (e.g., precision path regulation and operator command responsiveness) in the presence of low quality inertial sensors (gyros, accelerometers, pressure transducers) and “sloppy” actuators. The trajectory synthesis

based control solution proved to be robust in the presence of all such sensor errors and subsystem latencies. Mathematically speaking, for example, large inertial measurement unit (IMU) biases wash out in the closed loop at all levels of control. We have demonstrated – in flight tests – precision, highly responsive control (relatively high bandwidth design) with the use of low-grade inertial sensors and low performance actuators.

The VACS implementation currently provides the following set of control modes:

- R/C or Manual Control Mode
- Control-Stick-Steer Mode
- Programmed Maneuver Mode (See Table 1)
- Sensor-Slave Steering Mode
- Waypoint Guidance Mode (See Table 2)
- Park Mode
- Go To Mode (waypoint)
- Return-to-Base (RTB) Mode
- Launch Mode
- Fail-Safe Mode

Table 1: Programmed Maneuvers

Maneuver	Description
MAX CL	Climb at maximum climb rate to input altitude
BEST CL	Climb at best climb (most efficient) climb rate to input altitude
STEEP DEC	Descend at max descent angle to input altitude
SHAL DEC	Descend at approach descent angle to input altitude
BEST RNG	Cruise at best range speed
BEST END	Cruise at best endurance speed
MAX (SPD)	Cruise at maximum cruise speed
MIN (SPD)	Cruise at minimum speed
RT	Turn right an amount equal to the input value
LT	Turn left an amount equal to the input value
ABS HDG	Turn to the exact heading input
DISABLE D	Disable the programmed maneuver

Table 2 Waypoint Properties

Event Type	Waypoint, figure 8, racetrack, ellipse (circle is racetrack with equal length and width)
Waypoint latitude	Geodetic latitude of waypoint or orbit pattern center
Waypoint longitude	Geodetic longitude of waypoint or orbit pattern center
Waypoint Altitude	Ellipsoidal altitude of waypoint or orbit pattern center
Waypoint Speed	Speed setting at waypoint location
Orbit pattern length	Length of desired orbit pattern
Orbit pattern width	Width of desired orbit pattern
Orbit pattern orientation	Rotation angle of orbit pattern (relative to true North)
Number of orbit laps	Desired number of orbit laps
Time in orbit	Desired time to maintain orbit pattern (overrides orbit laps if greater than minimum threshold)
Orbit pattern center offset	Offset vector of orbit pattern center from known target location

### Synthetic Vision Displays

Geneva's industry partner, SDS International, has emerged as a leader in high-fidelity PC based photo-realistic synthetic visualization technologies. ArchAngel Synthetic Vision Displays (SVD), one of SDS' SVD products provides revolutionary improvements to the efficiency and effectiveness of the war fighters by providing real-time displays of 2D and 3D images that include threats, friendlies, and command and control overlays. The visuals offer complete and current sensor/decision maker/shooter information, plus situation awareness for safety and navigation. ArchAngel utilizes synthetic vision plus simulation functionality assimilated from Distributed Mission Training (DMT), DIS and HLA Tools, and Constructive Simulations to support combat missions.

ArchAngel is aimed at providing innovative visualization technologies as an "Information Portal" based upon XML and Intelligent agents to provide "Pull" and "Push" to address a broad range of sensor-decision maker-shooter issues. ArchAngel's design focus is to provide relevant real-time portions of AWACS, JSTARS, Rivet-Joint and sensor data to the cockpit of the shooters including relaying of Satellite and UAV imagery.

Geneva Aerospace has an ongoing funded effort to adapt the ArchAngel technology to the VACS

UAV control station environment to include in-time and coordinated sensor/decision maker/shooter information that is HLA distributed from the VACS ground control station to the synthetic visual displays. The displays include threat data realistically displayed over mapped and photo-realistic 3D terrain. Damage Assessment prediction visuals are supported with fire, smoke and even wind blown smoke. The key innovations include the ArchAngel project features of real-time multi-source fusion and display via Super-MFD and SDS's Fast-Panel technology.

The following figure illustrates examples of the visualization technologies, including "pathway in the sky" visual overlays and visualization enhancements gained from overlaying / fusing synthetic terrain with ortho-rectified, geo-registered imagery.

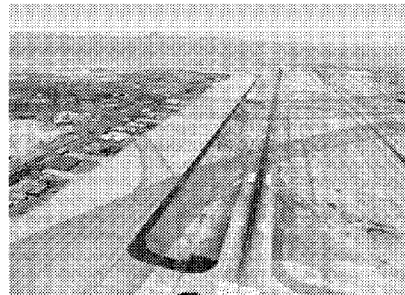

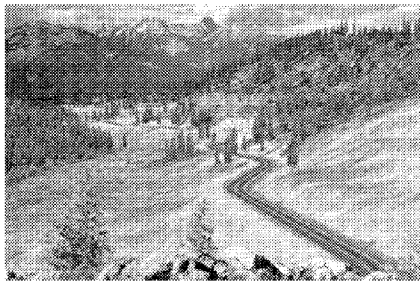
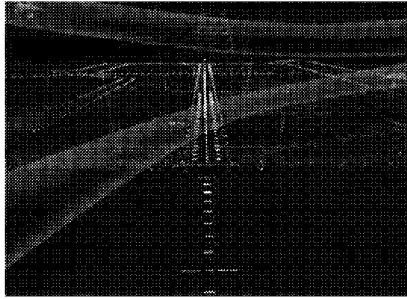

Figure 3 Photo-Realistic Synthetic Visualization Illustrations

The Synthetic Visuals are driven by the UAV in a manner very similar to the original design intent of a high fidelity flight simulator commanding own ship eye-point, environment and other entities. The main difference being that instead of a high fidelity flight simulator, live UAV state information drives the own ship eye-point. Furthermore, the other entities (ground-based threats, other aircraft, etc.) can be real-world sensed entities as opposed to simulated entities.

The photo-realistic, geo-specific visuals that were originally developed for training and

mission rehearsal are now directly usable in operational UAV contexts. In the simplest terms the GPS and INS data that report UAV position are utilized as inputs to the Synthetic Visual Display's API, which couples the state data with FOV and orientation information from the cameras and sensors onboard the UAV. Replication of the simulated visuals provides "perfect weather", daylight visuals regardless of the night, weather, fog, clouds, or camera/sensor battle damage. The use of wider FOV, multiple screens, augmented symbology and network integrated data exchange support an entire new generation of situation awareness enhancements, tools and operator decision aids, especially in the context of UAVs with flexible ground control stations and network interconnectivity.

The Synthetic Vision Display (SVD) technical approach is based upon integrating advanced simulated visuals originally developed for training purposes, into UAV operational systems. Specifically, the successful integration of SDS's Simulated Visuals with the Geneva VACS Ground Control Station (GCS) during recent AFRL sponsored flight testing at the Army's 10<sup>th</sup> Mountain Division training range at Ft. Drum, NY is indicative of the potential advances that merging these technologies can have in the near-term. Further, simulated HUDs developed for other training simulations have direct utility in the Synthetic Visuals. A high level description of the technical approach encompasses SDS International's Acuity Visual



Products to provide the basic synthetic visuals and some of the simulated HUD features. Additional "Super-HUD" functions, features and symbologies are being leveraged from AFRL/SDS's UCAV DMT Testbed effort, the Space Maneuver Vehicle Prototype, ArchAngel Prototype and AFRL VR-HMD R&D efforts. SDS's considerable experience with DIS and HLA has also lead to innovations utilizing the Dead Reckoning Algorithm's (DRAs) to reduce the frequency of communication updates required in the UAV operational context.

#### **Multi-UAV Control using VACS**

Key technology areas that have been employed to support the VACS multi-vehicle control research, development, and flight-testing include communications, controls, vehicle management, human factors, and simulations. The VACS design implements spread-spectrum communications hardware architectures and supporting multi-layered communications software packages that enable multi-vehicle messaging. Furthermore, we have conducted extensive work in multi-vehicle simulation development – both in the area of pure simulation based, network centric multi-vehicle analysis with Geneva's industry partner SDS International as well as in the more pertinent area of real-time system multi-vehicle simulation, including Processor-in-the-Loop (PIL) and Hardware-in-the-Loop (HIL)

simulation. The fundamental difference between the two simulation approaches is that the former approach placed less emphasis on real-world implementation concerns and focused on higher-level concept development whereas the latter is designed entirely around real systems and considers all pertinent real-world implementation concerns. The simulations from the latter approach drive our real-time, flight-worthy systems and, therefore, consider all of the limiting factors associated with the communications and flight control systems hardware and operating environments.

The multi-vehicle simulation studies have followed two approaches: 1) the Distributed Mission Training (DIS/HLA network protocols) approach for trade study analysis and 2) real-time, multi-system simulation using Geneva's internally developed multi-layered communications packages across RS232, 115.2 kpbs, using wireless RF (via spread-spectrum datalinks) connectivity between systems. For simulation studies in a non-laboratory environment, approach (2) uses the same-layered communications software package as in the lab environment, however the lowest level of the communications layer uses the Ethernet as opposed to the serial Input/Output device.

Finally, as discussed previously in this paper, we have designed and implemented a novel, variable autonomy vehicle management and control architecture that facilitate multi-vehicle

control with varying levels of functional allocation between the operator and the UAV network. Human factors engineering and live flight-testing have played key roles in the evolution of the VACS design. This gradient control implementation supports the full spectrum of autonomy from manual to supervised, to autonomous. The core architecture is highly flexible and offers a proven, core architecture to support the full evolution of the cooperative control solution.

Included in the VACS core are a set of mission health assessments generated based on much faster-than-real-time simulations that monitor vehicle performance utilizing UAV sensor inputs. Also included in the VACS core is an automated DTED based ground collision avoidance system. These capabilities play an important role, from the human factors perspective, in the multi-vehicle control problem as they offer automated system health monitoring and fault mitigation capabilities that significantly reduce operator workloads associated with managing a network of cooperative and non-cooperative UAVs.

As previously discussed, inherent in our efforts is the design and implementation of novel situation awareness technologies that facilitate effective management and control of multiple UAVs by a single operator. The VACS approach features mixed reality concepts using photo-realistic 3D synthetic vision displays

driven with both sensed and simulated vehicle state information.

Additionally, the work in variable autonomy controls has extended to the areas of automated collision avoidance technologies, where Geneva Aerospace has secured an ONR sponsored Autonomous Operations program to integrate VACS software with multi-vehicle sensing technologies to provide an optical sensor based automated air collision avoidance capability for UAVs. As evidenced by the research so far, the multi-vehicle cooperative behavior and control problem is dependent on both control system and situation awareness technologies.

#### **VACS GCS Software**

The VACS human-system interface (HSI) is a graphical user interface (GUI) that allows the operator to quickly alter the UAV course with little effort. The VACS HSI focuses on the UAV mission tasking rather than vehicle aviation; hence, the VACS interface places minimal significance on standard "cockpit" displays and focuses on situation displays. The operator interacts with VACS through the use of a mouse, a joystick (or game pad), and a keyboard. The software can easily be modified to take advantage of the touch-screen capabilities of the rugged notebook computer.

Push buttons in the main GUI provide access to dialogs that provide vehicle status information, sensor management and control functionality, and information dissemination capability through both data logging and network connectivity. A route editing dialog is accessed from the map display and provides the operator rapid, intuitive point-n-click system interaction for real-time mission planning and route editing capability, as well as map display editing features (zoom, center, change map background, etc). The route editing pop-up dialog provides the operator the capability to either type in known, precise waypoint coordinates or record graphically edited route event coordinates and parameters. The situation (map) display also contains a target editor with the capability to tie targets to UAV mission objectives and a corridor editor set no-fly zones and/or other mission planning boundary constraints.

Currently, the mission / route editing is performed manually by the operator, using the graphical user interface "point-n-click" functionality on the map or "fat-fingering" the coordinates. The interface, however, was designed generically so automated route plans can be accepted. VACS contains automatic route/mission analysis tools to alert the operator if a planned mission is not physically realizable due to vehicle performance constraints or terrain collision issues. Geneva Aerospace is planning efforts with various VACS customers to automate the entire in-flight route planning

process by integrating the Air Force's In-Flight Planning modules (3) with the VACS ground control station.

The VACS GCS also contains a Cautions, Alerts, and Warnings (CAWS) panel that alerts the operator to system malfunctions, low fuel, route errors, and various other off-nominal conditions. The CAWS display will alert the operator when a vehicle subsystem fault is detected.

Using the VACS GUI interface, the operator can maintain any level of control over the UAV, from fully manual to fully autonomous, with the simple click of a mouse.

A feature in the VACS GCS GUI is the incorporation of the Digital Terrain Elevation Database (DTED) with the map display and route planning tools. The VACS software includes a module that performs real-time interpolation on the DTED and provides terrain elevation at the vehicle's current geodetic location, along with a terrain elevation projection 5 km along the vehicle's current heading. Additionally, the DTED routine provides a real-time display of the operator's input device pointer location (such as the mouse cursor) over the map to provide rapid feedback of terrain elevation at selected geodetic locations. This DTED feature is used to aid in preflight and real time mission planning.

The DTED capability is currently being extended to the VACS airborne digital flight control system to provide a DTED-based automatic ground collision avoidance system (AutoGCAS) for both cruise missile and UAV applications. This AutoGCAS capability will be flight test demonstrated on the Dakota UAV testbed in late summer 2002.

The VACS design offers enormous flexibility to the UAV operator and reduces the operator workload to a level that facilitates the control of multiple UAVs by a single operator. The synergistic combination of the VACS design, the In-Flight Planning system, and the Synthetic Vision Display provide a comprehensive multi-mission, multi-vehicle automated UAV mission management and control system.

#### ***VACS TESTING***

Testing of VACS has consisted of hundreds of thousands of all digital Monte Carlo simulation cycles, hundreds of hardware in-the-loop (HIL) simulations, over a dozen developmental test flights on two different UAV platforms, and one operational scenario demonstration flight at the Army's 10<sup>th</sup> Mountain Division training range at Ft. Drum, NY.

The live flight exercises have demonstrated that a single operator with no aviation skills can simultaneously manage and control the UAV

and the UAV primary sensor. In these demonstrations, the operator was able to effectively transition control levels, update mission plans, monitor the UAV imagery, monitor the UAV systems status, and trouble shoot system malfunctions from the ground control station while the UAV demonstrated seamless mode transitions and at all times behaved as the operator expected and required. Furthermore, we demonstrated both in simulation and in flight exercises that the design eliminates common pilot induced faults such as pilot induced oscillation, stall, spin, over-g, or other pilot induced phenomena that over-drive the airframe and result in the loss of the vehicle.

During the Phase II effort, Geneva Aerospace teamed with Northrop Grumman Corporation to integrate the Variable Autonomy Control System ground control station with the Joint STARS Moving Target Exploitation (MTE) workstation to demonstrate the effectiveness of the VACS human-system interface and VACS UAV control approach in a real-world, airborne battle management system. The VACS control station proved to offer an effective, intuitive human interface for the Joint STARS operator. This capability was successfully demonstrated in a scenario representative of that of Figure 4, with the Joint STARS participation being simulated by a ground operator utilizing a modified Joint STARS MTE workstation. The next round of demonstration flights is scheduled for the late summer 2002 tests, and will

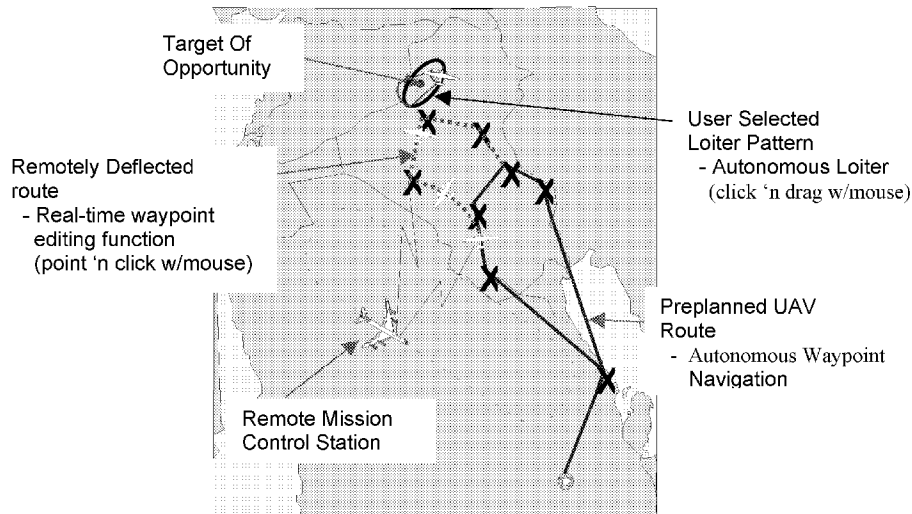

**Figure 4 Wide Area Surveillance Sample Mission**

showcase the multi-vehicle control, ground collision avoidance, and auto take-off and auto land capabilities.

### Conclusions

The Variable Autonomy control System (VACS) is a comprehensive, flight proven air vehicle multi-modal management and control architecture designed to support the emerging generation of autonomous and semi-autonomous UAV systems. The synergistic combination of advanced, gradient control concepts, intuitive human-system interfaces, and photo-realistic synthetic vision displays offers a comprehensive, off-the-shelf multi-UAV management and control package and provides a core flight control architecture that will enable

the rapid transition of autonomous UAV technologies to the war fighting community.

### References

1. Duggan, David S., "Demonstration of an Integrated Variable Autonomy UAV Flight Control System", Phase II SBIR Final Report, AFRL-HE-WP-TR-2001-0035, January 2001
2. Swihart, Donald E., et al, "Joint Development of an Auto Ground Collision Avoidance System", 4<sup>th</sup> Saint Petersburg International Conference on Integrated Navigation Systems, May 1997
3. Leavitt, Charles A., "Real-Time In-Flight Planning", May 1996, USAF Contracts F33615-92-C-3805 and F33615-94-C-1431

1  
2  
3  
4

**Exhibit 9** - From Geneva Aerospace Provisional Application 60/480,192  
**Small Business Innovation Research (SBIR) Program Projects**  
**Summary, Topic Number AF98-179**

APPENDIX B

U.S. DEPARTMENT OF DEFENSE  
**SMALL BUSINESS INNOVATION RESEARCH (SBIR) PROGRAM**  
**PROJECT SUMMARY**

TOPIC NUMBER: AF98-179

PROPOSAL TITLE: **Examination of an Integrated Autopilot Design for Simplified UAV Flight Control**

FIRM NAME: Geneva Aerospace, Inc.

PHASE I or II PROPOSAL: Phase I

---

Technical Abstract

In order to be truly versatile, Unmanned Aerial Vehicle (UAV) Systems must be usable to individuals who's training is more focused on the requirements of a given mission or on the usability of the payload, rather than on the aviation of the air vehicle. This suggests that flight control systems must respond to higher level, more intuitive remote commands such as "go left", "go right", "climb", or "dive".

Modern embedded guidance and control processing methods such as those used for autonomously guided cruise missiles or advanced military aircraft demonstrate that low-level stick-and-rudder commands can be eliminated as a requirement on the remote operator. In addition to a more intuitive command-response autopilot, Geneva Aerospace has developed a design which allows the integration of intuitive "mission-level" remote commands into the guidance system, significantly reducing the work-load on the operator as it pertains to the aviation of the UAV.

The guidance system is evaluated on the Freewing Tilt-Body airframe, which provides unique inherent camera stabilization and "Extremely" Short Take-off and Landing properties. The integrated guidance design and systems engineering approach proposed provides a modular core structure that can easily be upgraded and can grow with increasing technology.

---

Anticipated Benefits/Potential Commercial Applications of the Research or Development.

A well integrated mixed-reality guidance system could Make UAV's useful for border patrol, speed control, hazardous area investigation, atmospheric sampling, or even motion picture filming by persons who could operate with minimal aviation expertise or manual skill.

Keywords:

Unmanned Aerial Vehicle  
 Guidance/Autopilot  
 Virtual Reality  
 Telepresence

Mixed Reality  
 Autonomous  
 GPS Aided Navigation  
 Ground Station

Nothing on this page is classified or proprietary information/data  
 Proposal page No. 2

## 1.0 Identification and Significance of Opportunity

The nature of this research opportunity is best appreciated by first posing a set of top-level requirements for an "Ideal UAV System":

**The system must be easy to use with minimal training.** As recognized in the solicitation, an effective UAV system will respond to more intuitive command motions. This will allow the operator to focus on the payload and mission operations rather than on aircraft piloting. Commercialized products such as video games and CAD utilities provide an excellent model for human interfaces which have already been evaluated and tested on the open market. In fact, the ideal simplified UAV autopilot should be compatible with COTS hardware such as standard joysticks, track-balls, lap-top computers, and Virtual Reality Head Mounted Displays and Glove Input Devices.

**The system must be able to operate autonomously as well as respond to high-level remote commands.** Autonomous mission capability with the ability to remotely interrupt the mission is essential to minimize the work load of the operator when flying multiple-UAV's from a single ground control station. The ideal guidance concept will nominally operate with enough autonomy even when responding to remote commands that one person will be able to operate several UAV's from the same station.

**The system must be adaptable to on-going command-and-control software development efforts.** For military applications, the system will be required to operate within the advanced Command, Control, Communications, Computers, and Intelligence (C4I) infrastructure and interface with associated Common Ground Control Stations such as the Joint STARS Common Ground Station. As a commercial application, this could be a lap-top version of a somewhat less complicated, but similar ground control package. The guidance software must have the capability not only to respond to the command interface, but must also be capable of expanding modularly as new capabilities are desired without significant changes in the interface.

Advances in Virtual Reality simulation graphics display technology makes the concept of a Virtual Reality interface to real-time systems feasible. Already used by surgeons in the Medical community, the use of Virtual Reality, such as Telepresence or Mixed Reality systems, in UAVs is not far away. For this reason, we include an evaluation of a Line-of-Sight Slave mode capability in which the operator's point of reference is the image scene transmitted from the UAV's on-board camera (we will refer to this as the "tactical situation display"). In this mode the operator does not provide direct directional commands to the UAV. Instead, the operator focuses his attention on the tactical situation display, commanding the look angle of the UAV's on-board sensor to survey the battlefield (or other topographical region for non-military applications) while the UAV autonomously commands a flight profile which is slaved to the operator's sensor line-of-sight commands. As discussed below, our integrated guidance solution adapts easily to this mode.

**The system must be easy to land.** Even with directional-response controls, the operator must be capable of commanding the flare and touch-down phase of landing. To



eliminate this operator requirement, the simplified autopilot must be compatible with existing COTS automatic landing systems such as the Sierra Nevada Corporation's UAV Common Automatic Recovery System (UCARS), and hence must be able to land autonomously under nominal conditions. The system must also be able to respond to changes in the terminal approach when the operator detects an obstruction or desires a change in the landing conditions. In addition to its other benefits, the ESTOL capability of the Freewing Tilt-Body airframe design simplifies and reduces the risk of vehicle recovery over that of conventional fixed-wing UAVs

**The system will be highly modular, and manufactured from Commercial, Off-the-Shelf (COTS) components.** To compete as a marketable product, the system must be affordable, maintainable, and easy to upgrade. For the system to be flexible enough to do so, the guidance software must be designed to work under varying configurations with changing levels of uncertainty. For this reason, a robust, integrated control system design approach will be evaluated.

The above requirements point toward on-going Freewing Tilt-Body UAV development efforts by Freewing Aerial Robotics Corporation and Geneva Aerospace. The proposed SBIR study effort presents an opportunity to evaluate this system against the above desired capabilities, leading to a rapid development and marketing of the "Ideal UAV".

The Geneva guidance concept is founded in the understanding that a UAV can be controlled more like a missile than an airplane because human comfort is not a constraint. We can use a more flexible multivariable controller structure and can allow the airframe to perform conventionally unacceptable maneuvers such as negative accelerations, skidding turns, and high body-rate stabilization. Our controller structure integrates the guidance and autopilot sub-functions (outer loop path commands and inner loop stabilization). As we will show later in this proposal, the simplified autopilot concept is a straightforward augmentation of our integrated guidance design approach.

We have chosen the surveillance mission as a platform for evaluation because of its apparent commercial application potential. A well integrated mixed-reality guidance system could Make UAV's useful for border patrol, speed control, hazardous area investigation, atmospheric sampling, or even motion picture filming by persons who could operate with minimal aviation expertise or manual skill.

## 2.0 Feasibility of Technical Approach

The proposed technical design approach to the simplified autopilot and integrated surveillance system is made feasible by both the maturity and unique aerodynamic features of the host UAV platform, the Freewing Scorpion Model 100-50, and the maturity of the Geneva all-digital Six-Degree-of-Freedom (6DOF) simulation and integrated guidance design solution. A key feature of the Freewing design concept is its inherent ability to automatically neutralize the effects of turbulence on the fuselage, providing a host sensor platform which requires a significantly less expensive gimbal stabilization system than conventional fixed-wing air vehicles.

Geneva Aerospace has independently developed an integrated guidance design solution using modern robust control systems design techniques. This multivariable integrated guidance design solution provides a low-risk systematic design approach for the simplified autopilot application. The integrated guidance design solution uses system model uncertainties in the vehicle controller design, providing a robust controller design over the model uncertainty region.

## 2.1 Simplified Autopilot Feasibility

The simplified autopilot provides a UAV control mechanism which allows the remote pilot to provide intuitive directional commands rather than conventional stick and rudder commands. These so-called intuitive commands can be paralleled to outer loop guidance commands in conventional missile flight control systems. Typically the outer guidance loop in these systems provides fairly low frequency acceleration and bank angle commands to a three-axis (pitch, yaw, and roll) autopilot. It is this autopilot which is responsible for generating the commands to the actuators and performing the higher frequency body rate stabilization, thereby resolving the body accelerations and bank angle to the desired commands in a stable manner and tracking the desired trajectory. Such control systems have been in existence for decades and have been proven both in the test environment as well as on the battle-field. In recent years, the advancement of embedded controller technology (e.g., embedded microprocessors) has driven the industry standard to the use of digital autopilots. High performance microprocessors such as Intel's Pentium processors or Texas Instruments' C40 chips can be procured at relatively low cost, making the use of a fairly high performance digital autopilots in UAV systems cost effective and, therefore, feasible.

Geneva has combined the technology associated with high performance missile and aircraft fly-by-wire autopilots with the application of a remote piloted UAV to develop an integrated design solution which satisfies the need for a simplified UAV autopilot system. Utilizing a robust multivariable control system design approach, we have developed a *single* control structure for a UAV autopilot which is robust and modular in nature, allowing multiple levels of remote pilot control as well as fully autonomous flight. We believe that the proven digital autopilot technology in modern weapon systems and high performance aircraft combined with readily available commercial off-the-shelf (COTS) microprocessors and integrated GPS inertial navigation kits makes our concept the right solution for the next generation UAV autopilot.

## 2.2 Freewing UAV Description

The Freewing Scorpion Model 100-50 has been privately developed by Freewing and represents the culmination of nearly fourteen years of design evolution. The fairly recent formulation of diverse military UAV mission needs has created the venue for which this technology is most attractive. The first UAV variant of the Freewing design flew in 1992, manned variants having flown as early as 1983. The Scorpion evolved through 40% and 50% scale models developed by Freewing with Burt Rutan in 1992 and 1993, respectively. The design featured the freely hinged wing and vectored thrust gained simply by independently rotating the forward fuselage upward relative to the tail boom assembly. The Scorpion 100, also developed with Rutan, first flew in 1994. The Scorpion 100 capabilities include

conventional vehicle-like dash and cruise performance, an extremely short takeoff/landing capability, and turbulence mitigation characteristics. Additionally the vehicle is inherently stable and relatively insensitive to large center-of-gravity changes, making it an appealing platform for a variety of COTS sensors.

The Freewing Scorpion 100-50 provides extremely short takeoff and landing (ESTOL) performance in a simple, modular vehicle that provides a stable sensor platform while retaining all the advantages of a conventional fixed wing aircraft. The freewing tilt-body is a new kind of aircraft, distinct from fixed wings and rotary wings. It is a combination of two tested technologies, the improved free-wing and the tilt-body, which combine to provide an extremely short takeoff and landing aircraft that is stable throughout its flight envelope, while requiring only a few moving parts.

In the Freewing aircraft, the wing is placed on bearings so that it is completely free to rotate in pitch, de-coupling the wing in pitch from the fuselage. Trim surfaces on the trailing edge of the wing are used to control the wing angle of attack and to provide roll control. The resulting "flying wing" has a fraction of the effective pitching moment of inertia compared to an otherwise identical fixed wing vehicle. This allows the wing to rapidly and automatically adjust the angle of attack (as would a weathervane) in response to gusts and other changes in the relative wind. Traditional fixed wing aircraft must overcome the moment of inertia of the entire aircraft to accomplish the same change. But the rapid pitch response of the Freewing allows it to effectively maintain a constant angle of attack with respect to instantaneous wind direction for a given trim surface setting. In addition, the absence of a root moment means that only very small variations in the magnitude/direction of aerodynamic forces are transmitted to the fuselage. The result is a smoother, more stable flight and better sensor resolution since air turbulence is largely neutralized before being transmitted to the fuselage. NASA studies show that accelerations due to gusts are reduced by as much as an order of magnitude in a Freewing aircraft compared to a similar fixed wing aircraft. Conservative estimates developed for the Scorpion by Texas A&M show a 50% reduction in gust loading over the low frequency end of the wind spectrum.

With the Freewing Tilt-body vehicle, the de-coupling between fuselage and wing is taken a step further. Here, fuselage trim surfaces generate body pitching moments independent of the wings, effectively de-coupling the thrust vector from the aircraft velocity vector. The fuselage itself is a lifting body, so the result is a left/right wing pair joined by a rotating spar passing through the lifting body. Both the left/right wing pair and the central lifting body are free to rotate about the span-wise shaft.

The Scorpion tilt-body aircraft has all the attributes of the Freewing Tilt-Body class. The Scorpion 100-50 was designed by Burt Rutan and Scaled Composites, in collaboration with Freewing Aerial Robotics, to meet the original Joint Tactical UAV requirements. The Scorpion was designed to make maximum use of commercial off-the-shelf (COTS) equipment to reduce costs and ensure availability of spares. The following figure shows a side view of the Scorpion in both a take-off/land and cruise configuration. This figure also shows a planform view of the vehicle.

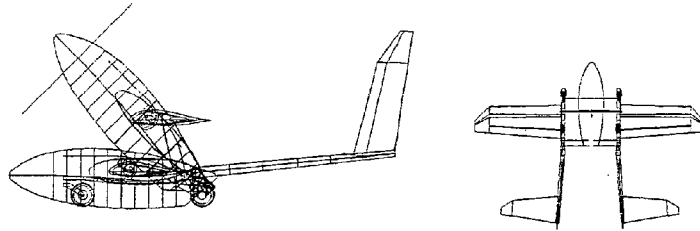

**Figure 1: Freewing Side-View and Planform**

The following table provides the main physical characteristics of the Scorpion 100-50.

**Table 1: Scorpion 100-50 Air Vehicle Physical Properties**

Total length	11.8 ft
Span	16.1 ft
Wing area (total)	37.3 sq ft
Freewing area	61% sq ft
Stub wing area	39% sq ft
Total height (cruise mode)	4.1 ft
Total height (tilt body mode)	6.75 ft
Maximum take-off weight	444 lbs
Empty weight	322 lbs
Maximum payload weight	50 lbs
Maximum fuel load	72 lbs
Power	52 hp
Max RPM	7000 (3000 output shaft)
BSCF	.52 - .57 lbs/hp-hr
Propeller	60" fixed pitch
Direction of rotation	CW (facing propeller)
Static thrust	270 lbs

**2.2.1 Freewing UAV Capability**

The following figures show the Scorpion Model 100-50 climb rate, flight envelope, range efficiency, and loiter efficiency. The predicted rate of climb as a function of airspeed and altitude is given in Figure 2, indicating a service ceiling of about 13 kft and a best climb speed of 60 to 70 knots. The resulting times to climb at full power are 5.0, 11.9 and 17.3 minutes to

5K, 10K and 12K feet, respectively. The maximum level flight envelope and service ceiling are shown on Figure 3. Since the vehicle's wing does not stall, the minimum speed will be determined by control limitations and maximum thrust. The indicated limitation at low speed is based on present flight test experience.

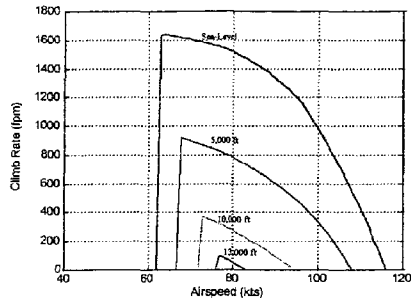

Figure 2: Rate-of-Climb

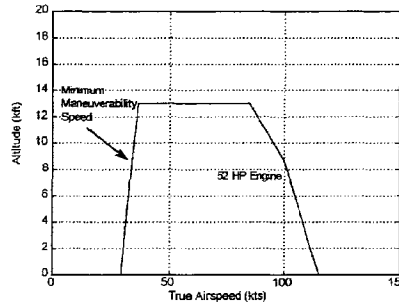

Figure 3: Flight Envelope

The range factor for this engine at sea-level is about 7 nm/lb at 65 knots. The endurance factor is predicted to be 6.8 min/lb. Data for this engine at altitude will not be available until the completion of the flight test program. We have therefore used the sea-level fuel consumption figures for range and endurance calculations for all altitudes.

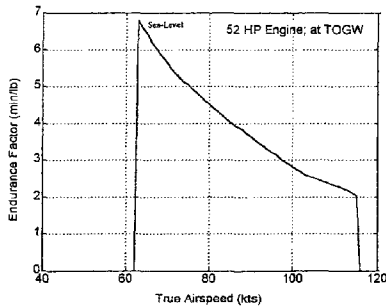

Figure 4: Endurance Factor

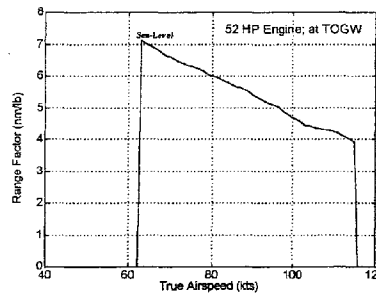

Figure 5: Range Factor

With a maximum fuel load of 72 lbs and an endurance factor of approximately 6.8 min/lb, it is evident that the Scorpion vehicle is capable of providing several hours of time on station. The Scorpion loiter efficiency combined with its inherent insensitivity to turbulence makes this vehicle an attractive platform for the development and test of the simplified UAV autopilot concept.

### 3.0 Phase I Technical Approach

We view the research opportunity for this effort to be two-fold. The Geneva integrated guidance design approach merges the seeker, GPS/Navigator, guidance/autopilot, and remote command sub-functions in a structure that will greatly reduce workload and training requirements for the operator. In addition to the functionality of this design, we will assess a systems engineering design approach which will result in a lower-cost, more produceable, and more maintainable UAV. We therefore additionally propose to gather data which will show a cost benefit to our improved integrated systems engineering process.

### 3.1 Control System Architecture

Our controller design approach introduces several high-level operational modes, with varied levels of automation:

Energy-Optimization: Autonomous flight with only a single observation point and time-on-station requirement. The guidance determines speed, altitudes and flight paths to minimize energy expenditure.

Pre-Planned Waypoint: The vehicle flies the pre-programmed waypoints, either specifying speed and altitude, or allowing the UAV to autonomously determine them from the energy management system.

Real-Time Waypoint Editing: Can be entered at any time during a mission by specifying a waypoint that the UAV can physically reach from its current location, or by changing the location of an existing waypoint.

Directional Response Autopilot: Entered automatically by moving the joystick. The joystick commands immediately override the existing commands and relate to changes in flight path.

Line-of-Sight Slave: The vehicle heading is commanded to align with the camera line-of-sight commands until the vehicle comes within a specified radius, in which case it is commanded to circle the designated point.

These operational modes suggest an hierarchical control structure with varied levels of remote pilot command insertion. For example, when flying in the "stick and rudder" mode, the pilot commands would be inserted at the lowest control level immediately prior to actuation. Conversely when flying the directional-response autopilot, the commands will be inserted as vertical or horizontal flight path turning rates. LOS Slave commands would be inserted at the guidance command level. Figure 6 shows the proposed control loop organization structure:

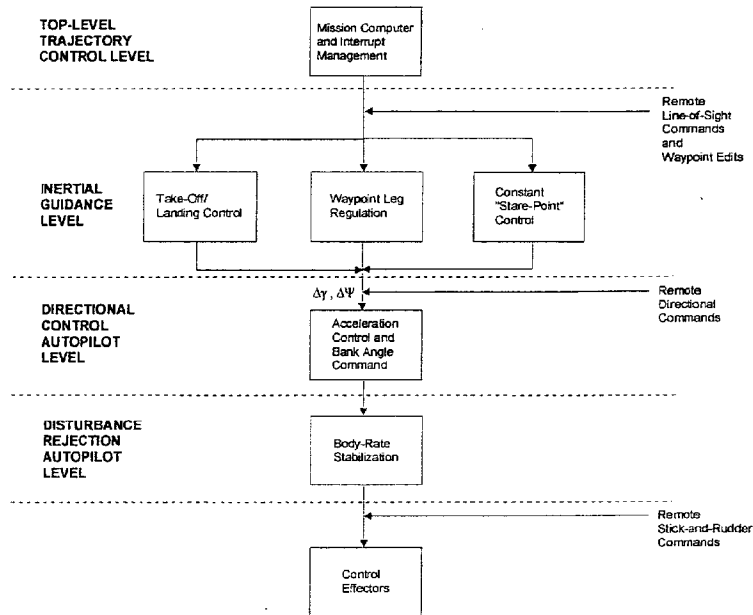

**Figure 6 Airframe Control Structure Organization**

Perturbations in flight path and ground track angles ( $\Delta\gamma$  and  $\Delta\Psi$ ) provide the command signals used for outer loop guidance because they can be mapped directly to “go up/go down” and “go left/go right” intuitive commands and because they lend themselves well to the inertial control laws which are used for the autonomous guidance modes. Figure 6 shows several parallel processing paths at the guidance level. Processing for the outer-loop control is determined by the top-level trajectory control, which is driven primarily by the remote pilot’s mode selection and by inertial trajectory requirements. This controller structure leads to a more modular software architecture, which will be useful for future capabilities or use on other UAV systems.

By mapping joystick motion into  $\Delta\gamma$  and  $\Delta\Psi$ , we can achieve the added benefit that letting go of the joystick (referred to here as “stick-free”) will result in constant velocity, straight-and-level flight. This will be valuable to the operator when he/she needs to change to another task such as camera slewing or waypoint editing without having to switch to a completely autonomous autopilot mode.

The primary modes for use, and therefore the focus of the evaluation efforts will be on the directional-response autopilot, the LOS slave mode guidance, and the waypoint editing capability. The following discussion defines the operational concept for each of these modes.

**Directional-Response Autopilot.** The purpose of directional command response is to enable an untrained operator to maneuver the vehicle in a stable manner as he or she affects

the trajectory from ground-station information without having to compensate the faster loop dynamics of rate stabilization, aerodynamic coupling, or speed control. This can be achieved by associating changes in flight-path with the joystick motion, and by injecting these commands into a multi-variable digital autopilot which autonomously controls engine throttle, thrust vector setting, and body rate stabilization. Figure 7 shows the proposed multi-variable control loop structure, augmented with the higher-level functions.

When operating in directional response mode, the joystick commands are converted to flight-path angle change commands through a scheduled gain. This gain must be scheduled versus thrust setting and body tilt angle to maintain equivalent command-per-joystick deflection slope.

The operator will have command of speed control via a simplified, constant setting on his/her display. The directional commands and velocity setting comprise the command vector entering the autopilot. It should be pointed out that the other operational modes also provide the same command signals after some level of processing.

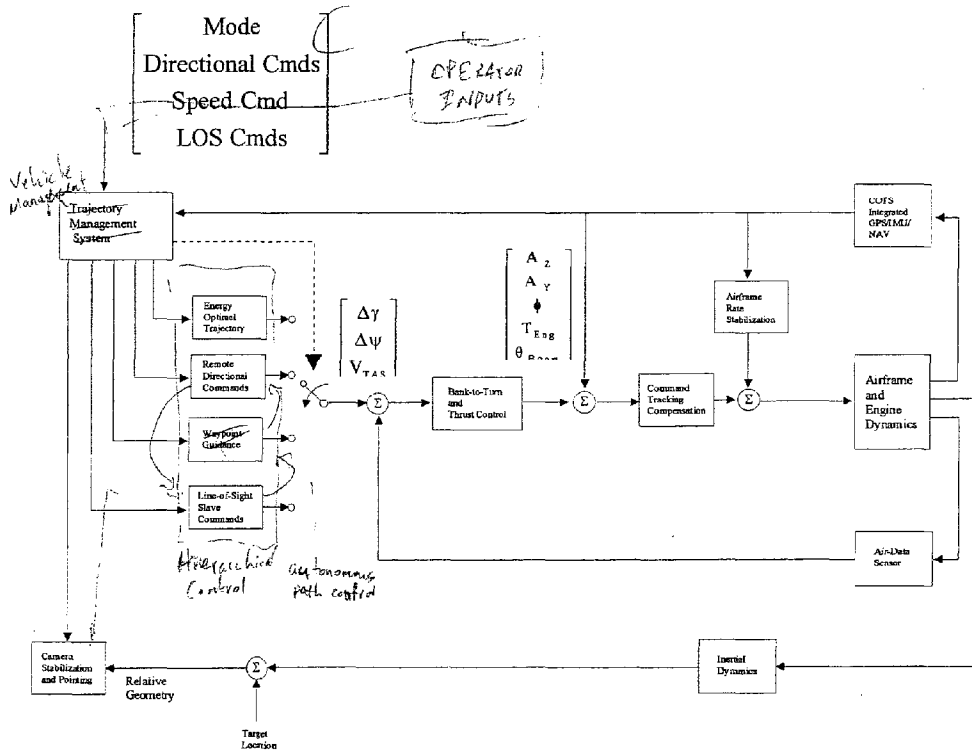
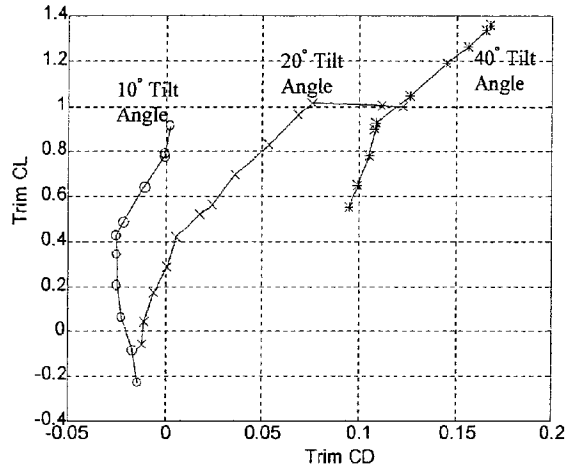

Figure 7 Multivariable Control Loop Structure



The Tilt-Body provides a unique thrust-vectoring capability which is optimally utilized in the thrust vector controller. Figure 8 shows that there are several trim points for most operating conditions across the locus of boom angles and elevator deflections. The data depicted in this figure represent the sum of the aerodynamic force coefficients and installed thrust coefficients at a 50% throttle setting.



**Figure 8: Trimmed Lift vs Drag**

The above figure shows both the benefits and penalties associated with the thrust vector. For example, note that when the body tilt is increased from 10 to 40 deg, the total maximum lift capability at 50% power increases by 50%. Also note, however, the severe drag penalty associated with the high boom angle configuration. Consequently, these trim solutions are scheduled as functions of energy management constraints, maneuverability requirements, and desired speed. The curves are synthesized into an integrated multi-variable boom angle and throttle control, which are driven by the operator's speed and mode settings as command inputs. The low speeds available from the Tilt-Body will be a benefit for surveillance purposes, but can result in aerodynamic stall on the tail surfaces. This is particularly a concern when flying at higher boom angles, where the vehicle must fly at slow speeds in order to maintain speed trim. For this reason, the stall limits are multi-dimensional in nature and include a predictive stall-avoidance algorithm.

Because the operator may be inexperienced or otherwise occupied, the system includes control deflection and command limits at several levels to prevent non-linear aerodynamics such as stall and cross-channel coupling, over-expenditure of any mixed control surface in a single axis, structural over-loading, or actuator slew rate limiting.

#### LOS-Slave Control

The directional-response autopilot, combined with the stabilized seeker platform allows a single minimally trained operator to easily conduct a UAV surveillance mission. A further level of user simplification is achieved by combining seeker designation command logic with the outer

loop guidance. This mixing provides Line-of-Sight Slave mode capability in which the operator's point of reference is the image scene transmitted from the UAV's on-board camera. In this mode the operator does not provide direct directional commands to the UAV. Instead, the operator focuses his attention on the tactical situation display, commanding the look angle of the UAV's on-board sensor to survey the battlefield (or other topographical region for non-military applications) while the UAV autonomously commands a flight profile which is slaved to the operator's sensor line-of-sight commands. This integration of the camera platform with the guidance provides the following benefits:

1. Time-on-station loiter control which can be easily selected and designated.
2. Further reduction of workload on the operator, who can now focus primarily on the surveillance aspects the mission.
3. An easily adaptable relative Navigation method.

Figure 9 shows an example of how LOS-slave control would be used with the ground station display. The Navigation display would be a top-view with a schematic of the aircraft for easier conceptualization. This symbology would be added to the set of flight state information normally found on the display. The outer circle around the aircraft is a projection of the entire seeker field-of-view onto the ground. The smaller pie-shaped queue is a ground projection of the current seeker borsight position. These would be calculated by the ground station software from the positional information and seeker angle sent across the data-link.

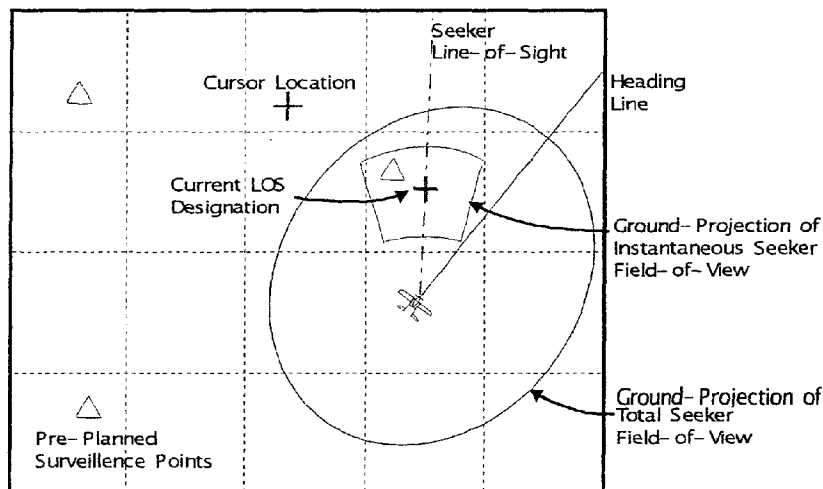

Figure 9 Augmentation to Tactical Situation Display

The remote pilot can opt to either keep the cursor active as the continual steering point, or he/she can designate a "surveillance-point" by clicking on a desired ground location. In the latter case, the staring point would be captured so the cursor could be moved to a new constant location.

If the pilot chooses a surveillance location outside the total FOV, then the outer loop guidance will follow a command-to-LOS mode guide law until the UAV flight path points toward the target. Once the desired staring-point comes within a minimum range threshold, the guidance automatically trips into a loiter pattern (either constant-radius or elliptical) to maintain track on the desired location. This guidance structure allows the operator to park the vehicle at a station with a single key-click while he/she conducts other activities. Figure 10 shows a diagram of the surveillance-point approach scenario.

If a constant location is selected within the minimum turning radius, then the guidance must fly over the surveillance-point and plan an out-and-back pattern to avoid a singularity in the loiter guide-law. This can be easily achieved by inserting waypoint legs autonomously.

If the operator chooses, he/she can select a standoff range (or accept the default range) for surveillance over a hostile target. The seeker line-of-sight commands will also comprehend the offset location to track on the desired location. This is achieved by inserting the offset range vector in the positional component of the loiter guide-law.

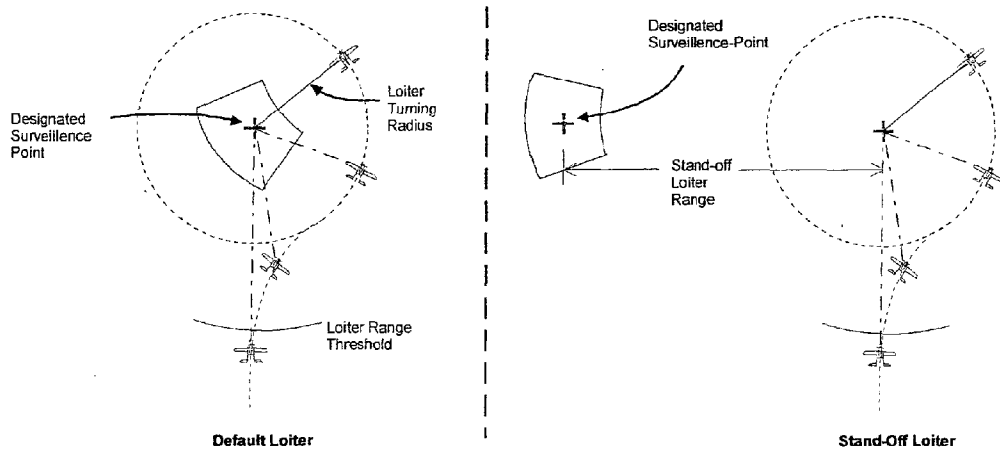

Figure 10 Surveillance-Point Approach Trajectory

The following simplified equations are used to show the basic structure of the LOS Slave mode guidance:

If (  $R_{Target} > Loiter\_Threshold$  ) then

$$\dot{\psi}_{Cmd} = K_{\psi} (\lambda_{Horiz} - \psi_{Heading})$$

$$\dot{\gamma}_{Cmd} = K_H (H_{CMD} - H) + K_H \dot{H} + \frac{g}{V}$$

else

$$\dot{\psi}_{Cmd} = K_{\psi} \Delta\psi + K_{\rho} \left( \rho_{Turn} - \left\| \bar{R}_{Target} + \bar{R}_{S \tan \epsilon - Off} \right\| \right)$$

$$\dot{\gamma}_{Cmd} = K_H (H_{CMD} - H) + K_H \dot{H} + \frac{g}{V}$$

endif

where

$R_{Target}$  = Horizontal Range - to - Target

$\dot{\psi}_{Cmd}$  = Horizontal Turning Rate Command

$\Delta\psi$  = Heading Error Relative to Loiter Path

$\lambda_{Horiz}$  = Horizontal Line - of - Sight to Target

$\dot{\gamma}_{Cmd}$  = Vertical Turning Rate Command

$\psi_{Heading}$  = Heading Angle

$\rho_{Turn}$  = Loiter Turning Radius

H = Altitude

g = Gravity Acceleration Magnitude

V = Vehicle Inertial Velocity Magnitude

The above equations show two active horizontal guidance terms when flying the constant turning radius circle. The first term is the damping term which drives the vehicle to align its ground track with the desired circular loiter pattern and is the dominating term. The second term is a positional term to help maintain the constant arc.

#### Waypoint Mode with Real-Time Waypoint Editing

The waypoint guidance system is organized as a linked list of waypoints augmented with smooth turn and leg propagation logic at each station. This provides the capability to easily edit the waypoint list from the graphical display both during pre-flight mission planning and while the UAV is in the air.

The operator will now have the ability to insert waypoints visually with a track-ball or mouse. If the operator discovers an unknown hazard in the pre-planned flight-path, then he can either "drag-and-drop" the existing waypoints or he can delete and insert new waypoints as necessary.

By grabbing the joystick, the operator automatically overrides the waypoint mode and enters directional response mode. Waypoint mode can be re-entered by commanding the vehicle back to alignment with the current waypoint leg.

#### Autonomous and Directional Response Landing

The usability of typical UAV systems is strongly dependent upon how much skill and instrumentation is required at landing. Completely autonomous landings with conventional fixed-wing UAV's are only possible with very accurate terminal altitude instrumentation such as a millimeter-wave capture and recovery systems, differential GPS Navigation, or RADAR altimeters.

Most systems rely upon remote piloting at the terminal phase. Landing would present a challenge to the simplification of the remote pilot commands because of the complexity and timing of the terminal flare maneuver. However, the Tilt-Body design provides a solution to both autonomous and simplified-remote command landings. When the vehicle flies at high body tilt angle, a large component of lift is afforded at very low airspeeds. This makes it possible to fly the vehicle at steady-state terminal sink rates which will not harm the structure of the vehicle at impact. With this feature, the pilot needs only to command a landing point, and the vehicle guidance responds by setting up its own terminal leg geometrically. A weight-on-wheels sensor is added to shut off the motor at impact and to command negative lift on the Freewing.

The operator can correct the terminal flight-path if he visually detects an obstruction, or he can land the vehicle purely with the directional response autopilot. In this case, the internal command limits prevent him from slamming the vehicle into the ground with too much vertical velocity.

### **3.2 Typical Mission Profile**

The utility of the modes discussed above are demonstrated with an example of how they might be used for a surveillance scenario. The sequence of events correspond to the diagram in figure 11:

- (1) After take-off, the operator points the camera or seeker with the joystick as the UAV flies autonomously along either pre-planned or real-time inserted waypoints.
- (2) Operator-controlled maneuver to avoid reported hazard along flight path. The mode is invoked automatically by grabbing the joystick.
- (3) By letting go of the joystick (and not yet designating to re-capture waypoint plan), the UAV flies straight-and-level while the operator scans the seeker.
- (4) Operator designates a stand-off surveillance of one of the original mission objective points.
- (5) The operator edits the original waypoints to command a return-to-base, flying by the second mission objective point.
- (6) Operator evokes continuous LOS Slave control to examine third target.
- (7) Operator commands a loiter prior to approach in order to coordinate with other mission objectives or vehicles.
- (8) Applies the terminal waypoint to establish the run-in heading.

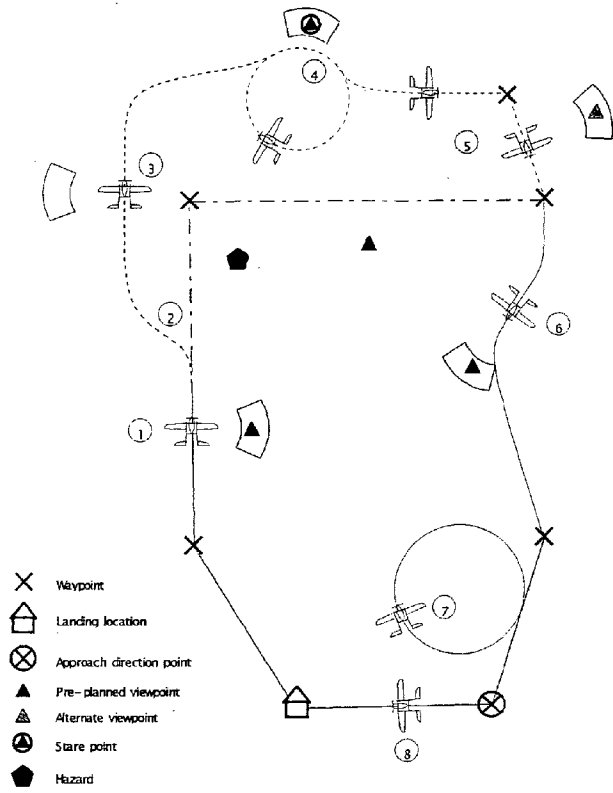

Figure 11: Sample Mission Profile

### 3.3 Systems Engineering Approach

The systems engineering process is modified to develop systems with COTS components by enabling us to evaluate the contributions of each subsystem to the top level requirements as well as the subsystem component interactions in the presence of a synthesized controller.

Rather than beginning with subsystem requirements from systems engineering trade studies, our process begins with cost and performance data from existing production-ready components. We will design modularity into the system by recognizing those de-facto interface standards which exist with the most cost-effective components. The guidance and autopilot compensation is then developed in parallel with the trade studies identifying the subsystems to be used. This allows us to trade-off certain characteristics of subsystems for equivalent top-level performance. For example, the degraded performance of a lower-cost IMU may be acceptable if slightly better actuators are available.

The cost/performance trades will be evaluated by observing their effects on the highest reasonable level of performance requirements. Several candidate systems will then be projected,

and their performance plotted versus cost. The most cost-effective system will then be identified, and the associated performance characteristics become the system specifications. If the resulting performance is less than what would be considered marketable, then the next higher performing candidate system will be chosen. Subsystem allocations will then be completed by recognizing the specifications of those already-procured components. This design approach has several benefits:

1. The development cycle-time and associated cost is greatly reduced by avoiding procurement on the subsystem level.
2. The design is modular by definition, thereby facilitating future subcomponent upgrades or system capability expansion.
3. The development cycle results in a low-cost, production-ready system design.
4. In this case, the system design can more effectively take advantage of the Freewing Tilt-Body's unique flying qualities.

### 3.4 Research Plan

We have introduced a guidance design concept and systems engineering approach that we believe can fulfill the list of requirements posed for a usable and versatile UAV system. Throughout phase II and into development, the final ground station and interface may take one of several possible forms. We feel our UAV guidance/autopilot structure will be compatible with existing C4I Common Ground Control Stations and will facilitate the advance of the UAV surveillance community into the realm of Virtual Reality, linking the senses of the operator with the sensors from the remote platform. We intend to show this by performing a simulation-based integration of the above guidance laws and relevant modeling parameters.

We will then perform a series of simulation trade studies and cost analyses to demonstrate the effectiveness of our integrated guidance design with the Freewing airframe. When complete, our results will either position us to begin phase II efforts or they will point toward other development tasks that should be pursued. The following work breakdown structure is proposed:

#### 1.0 Industry survey of COTS performance parameters.

We will attempt to collect enough COTS subsystem cost and performance data to simulate at least 3 candidate integrated system designs. We will also collect the data necessary to model the subsystems.

#### ✓ 2.0 Update 6DOF simulation to include subsystem models and interface.

In addition to subcomponent models, a set of prototype controller hardware must be integrated with the simulation. This will include a standard COTS joystick and mouse with appropriate driver software. This will not include a prototype of the ground controller interface.

✓ 3.0 Integrate the directional-response controller into simulation.

This integration effort will include the core multivariable controller structure with the body tilt angle and thrust vector regulator as well as bank-to-turn autopilot.

✓ 4.0 Integrate Line-of-Sight Slave mode controller into simulation

✓ 5.0 Integrate waypoint-guidance mode controller into simulation

6.0 Assess performance and usability of the high-level controller functions

A simulation-based study will seek to answer the following questions:

- Is this controller intuitive and usable by an untrained pilot ?
- It the controller robust and stable under all operating conditions ?
- Can the operator over-drive the UAV, or does the software effectively limit his/her commands ?
- Can the controller be implemented with existing data-link interfaces ?

7.0 Perform a cost-performance build-up on the candidate systems and assess optimal cost vs. performance system

8.0 Investigate interfaces and expandability of current ground control stations and mission planning modules.

The last effort will be important to establish the basis for phase II planning. We will seek opportunities to acquire government-furnished ground station equipment which would represent the perceived direction of technology.

## 4.0 Related Work

Geneva Aerospace is currently under contract with Freewing Aerial Robotics, Inc. to assess the performance capability and to develop an operational autopilot for the Freewing Tilt-Body series of UAV's. In order to execute this contract, Geneva is also currently developing a Six Degree-of-Freedom simulation which accurately models the Freewing's unique kinematic and aerodynamic properties. These and the other significant development efforts are identified discussed:

University of Maryland, MATRA BAe and Texas A&M Wind Tunnel Tests

Freewing and its partners have logged over 560 hours of wind tunnel testing for use in the development of a Freewing Tilt-Body aerodynamics model. Researchers at the University of Maryland, Texas A&M University, and most recently, Geneva Aerospace have teamed to analyze the Freewing wind tunnel data and develop a realistic Freewing Tilt-Body vehicle aerodynamics model. Geneva Aerospace has integrated this aerodynamics model into a 6DOF simulation for use in the development of an automatic flight control system for the Freewing UAV. Geneva has also used this aerodynamics model to conduct a comprehensive vehicle performance assessment.



#### Boeing Instrumented Flight Test Series

Freewing has recently teamed with Boeing to conduct a comprehensive instrumented flight test program using the Scorpion Model 100-50. This flight test program is the first in a planned series of test programs to collect real flight test data which will be used to validate the Freewing aerodynamics model as well as the propeller, engine, and actuator models used in Geneva's 6DOF simulation. This flight test program along with the follow-on aerodynamics and simulation model updates will be completed prior to the AF98 Phase I SBIR contract award, providing both technical merit for entrance into a Phase I study effort as well as risk reduction for advancement to a Phase II flight test demonstration program.

#### Geneva Six Degree-of-Freedom Simulation

Geneva is currently developing a generic off-the-shelf six degree-of-freedom simulation to support this and several other design and analysis efforts. The long-term goal of this effort is to provide a validated and accredited core simulation package for missile, UAV, and aircraft development efforts. The simulation is highly modular and written in the C++ object-oriented language.

The Freewing dynamics model and aerodynamic database has been integrated into the generic 6DOF, which is currently being used for on-going performance evaluation and design trades.

#### Freewing Tilt-Body Development Program

Most recently Freewing has been in active development of a variant of its Scorpion Tilt-Body in collaboration with Europe's Matra BAe Dynamics. This variant, known as the "Marvel," is to be employed by the French Navy for use aboard its frigates and other surface combatants. This ambitious program is scheduled to demonstrate the suitability of the Scorpion platform in the late 1998 time-frame. The program gained a further boost amid indications that the French Army may consider a 60% scale version for its UAV reconnaissance needs.

#### Geneva's Integrated Guidance Systems Design Methodology

The desire for more use of COTS components in modern military applications calls for a modified systems engineering design approach. We feel that this can be done more effectively by focusing on the highest level requirements, and by designing the embedded controller to optimize the interactions between the subsystems. Geneva has developed a methodology which uses the framework of modern robust control theory to synthesize a controller, allowing us to assess the effects of degrading subsystem uncertainties on top-level performance. From there, a comprehensive Cost vs. Performance curve can be developed, whereby cost can truly be treated as an independent design variable. It is the merging of systems engineering, COTS subsystem procurement, and multivariable robust control theory that makes this approach so unique.

### **5.0 Relationship with Phase II Work**

As the development of the Freewing aerial vehicle progresses, the guidance, navigation, and ground station systems must develop in parallel. Although an innovative guidance system architecture has been developed from projected mission profiles, several questions regarding the

usability of our design must be answered prior to entering full-scale system development. The results of the phase I research will provide the critical information needed to enter into the full-scale development of the integrated system.

With this information, Freewing and Geneva will propose a phase II integration and test plan with the goal of developing a complete low-cost UAV capable of interfacing with current and future ground stations, payloads, and seekers.

## **6.0 Company Information**

Geneva Aerospace is a progressive engineering firm specializing in integrated flight control systems technology. Formed in 1995 and formally founded in early 1997 by several Members of the Group Technical Staff of Raytheon-TI Systems, Geneva's flight control systems team has a proven track record on various military weapon systems programs such as the U.S. military's Joint Standoff Weapon (JSOW), High-Speed Anti-Radiation Missile (HARM), and the Extended Range Guided Munitions (ERGM) weapon. Geneva's staff specializes in design and implementation of inertially guided autonomous glider weapons and maintains leading-edge expertise in robust real-time control system design techniques.

Freewing Aerial Robotics Corporation is one of a new breed of high-tech companies launched in university-based business incubators, in a special kind of public/private partnership, with its R&D partially funded by competitive government technology grants. Consulting and shareholding agreements with other engineers, such as Burt Rutan and John Roncz, expand Company capabilities. A number of Texas A&M University faculty members and graduate students also work extensively with Freewing. Freewing has been selected by European aerospace giant Matra BAe Dynamics as partner and vehicle subcontractor in a UAV proposal to the French government.

## **7.0 Key Personnel**

### David Allen Felio - Principal Investigator

Dave Felio has developed autonomously-guided weapon systems as an autopilot and guidance specialist at Texas Instruments Missile Systems Division for the past 11 years. He has had extensive experience developing anti-radiation homing missiles, GPS inertially guided glider weapons, and cannon-launched smart munitions. He is currently a Member of the Group Technical Staff at Raytheon-TI Systems, and has served as the lead G&C systems designer for the Joint Stand-Off Weapon System, RTIS's Interdiction Weapons Division, and several proprietary development programs. Mr. Felio holds a Masters of Mechanical Engineering with an emphasis in control theory from the University of Texas at Arlington, and a Bachelor's Degree in Electrical Engineering from Texas Tech University.

David Shane Duggan

Dave Duggan has developed missile systems as an autopilot and guidance specialist at Texas Instruments Missile Systems Division for the past 8 years. He has had extensive experience developing anti-radiation homing missiles, GPS inertially guided glider weapons, and precision guided imaging missiles. He is currently a member of the Group Technical Staff at Raytheon-II Systems, and has served as the lead G&C systems designer of the Unitary variant of the Joint Stand-Off Weapon system for the past 3 years. He currently holds the lead G&C systems functional position over RTIS's Interdiction Weapons Division. Mr. Duggan holds a Bachelor's Degree in Aerospace Engineering from the University of Texas, Arlington.

## 8.0 Facilities

Geneva Aerospace maintains state-of-the art computing platforms and engineering software to support analysis, simulation, and control system design work for Freewing. All hardware integration necessary for the studies will be conducted on-site at the Freewing facility in College Station.

Freewing's research and development laboratory is housed in a 20,000 ft<sup>2</sup> complex of four buildings in College Station, Texas. Freewing conducts its flight tests at an airport on the Riverside campus of Texas A&M University, which participates in flight testing as a subcontractor to Freewing.

Freewing has formed a business arrangement with L&L Tooling & Manufacturing, Inc. of Itasca, Texas, to acquire pre-production models of its Scorpion Tilt-Body and to gain production tooling. L&L is a premier maker of composites tooling, whose customer list includes Rockwell, Gulfstream and Bell Helicopter. Freewing's production line for the Scorpion Model 100-50, a 50-pound payload Freewing Tilt-Body UAV, is scheduled to open in 1997 in Texas. Several Scorpions have been produced from the soft production tooling. The final tooling will be capable of producing up to one aircraft per day.

## Bibliography

- Porter, R.F., Hall, D.W., Brown J.H., Gregorek, G.M., "Analytical study of the Free-Wing Free-Trimmer Concept", NASA CR-2946, February 1978.
- Chen, W. & Barlow, J.B., "Stability, Control and Gust Response Characteristics of an Ultralight freewing Aircraft", AIAA-92-4342, Atmospheric Flight mechanics Meeting, Hilton Head, SC, August 10-12, 1992.
- Chen, W. & Barlow, J.B., "An Ultralight Freewing Aircraft Design Study", AIAA-92-4194, AIAA Aircraft Design System Meeting, Hilton Head, SC, August 24-26, 1992.
- Chen, W., "Stability, Control and Gust Sensitivity of a Low Wing Loading Freewing Airplane", M.S. Thesis, 1992.
- Barlow, J.B. & Chen, W., "Aerodynamic Characteristics and Control Aspects of a Freewing Tilt-Body Airplane", presented at the Twelfth Bristol International Conference on RPVs, 9-11 September 1996, Bristol, UK.



12. Total Costs	\$ 76,375
13. General and Administrative (15%)	\$ 11,456
14. Fee (7%)	\$ 5,346
15. Total Firm Fixed-Price Cost	\$ 93,177
16. Type of contract proposed: Firm-fixed-price.	

17.

- a) Has any executive agency of the United States Government performed any review of your accounts or records in connection with any other government prime contract or subcontract within the past twelve months? No.
- b) Will you require the use of any government property in the performance of this proposal? No.
- c) Do you require government contract financing to perform this proposed contract? Yes. If yes, then specify type as advanced payments or progress payments. Progress Payments

---

David A. Felio  
President

---

Date

1                    **Exhibit 10 - Geneva Phase I Contract information for AF98-179**  
2    from Air Force SBIR Web site at  
3                    <http://www.afsbirsttr.com/TechMall/Default.aspx?kwa=AF98-179>

- GOVERNMENT
- SMALL BUSINESS
- PRIME CONTRACTOR
- ACADEMIA

**Program Office**

Air Force Research  
 Laboratory (AFRL/XPP)  
 1864 4th Street  
 Bldg 15 Rm 225  
 Wright-Patterson AFB,  
 OH  
 45433  
 Toll Free:  
 1-800-222-0336  
 Fax: (937) 255-2219

**AWARD DETAILS**

[Back to List](#) [Printer Friendly](#)

**AIR FORCE**

**Proposal #:** 98AL-306      **DoD Submission #:**  
**Phase:** I      **Program:** SBIR  
**Proposal Title:** Examination of an Integrated Autopilot Design for Simplified UAV Flight Control  
**AF Sol Topic #:** AF98-179      **DoD Technology Area:** Air Platforms  
**Solicitation #:** 98.1      **Gov't Managing Office:** RH  
**Agency:** AF      **Gov't Sponsoring Office:**  
**Topic Title:** Simplified Manual Flight Control

**AWARD DETAILS**

**Status:** Successful (Invited for Phase II)  
**Amount:** 93177      **Contract:** F41624-98-C-5058  
**Start:** 5/14/1998 12:00:00 AM      **End:** 2/14/1999 12:00:00 AM  
**Annual Report FY:** 1998  
**Transition Success Story written?**      **Impact Story Submitted? No**  
**HUBZone:** No  
**TRL Level:** Level 3  
**TRL Application:** Analytical and experimental critical function and/or characteristic proof-o- concept  
**DTIC Rpt. Date:** 3/20/2001 12:00:00 AM      **DTIC Rpt. Num.:** AFRL-HE-WP-TR-1999-0017-  
**DTIC Accession Number:** B242868

**FIRM DETAILS**

**Firm:** Geneva Aerospace, Inc.      **Socially & Economically Disadvantaged Business?:** No  
**Address:** PO Box 613018      **Woman Owned?:** No  
**City:** Dallas      **Veteran Owned?:** No  
**State:** TX      **Disabled Veteran Owned?:** No  
**Zip:** 75261      **HBCU/MI:** No  
**Employees:** 6      **HBCU/MI Name:**

**CONTACT INFORMATION**

**Project Manager Name:** David A. Felio  
**Project Manager Title:** President  
**Project Manager Phone:** (972) 317-3124  
**Project Manager Email:**

**Corp Official Name:** David S. Duggan  
**Corp Official Title:** Secretary and V.P.  
**Corp Official Phone:** (940) 440-9312  
**Corp Official Email:**

**APPENDIX B**

**Abstract:**  
 In order to be truly versatile, Unmanned Aerial Vehicle (UAV) Systems must be usable to individuals who's training is more focused on the requirements of a given mission or on the usability of the payload, rather than on the aviation of the air vehicle. This

**TOPIC/AWARD DATA**

**LOGIN**

Please select the area you work within in relation to the SBIR & STTR programs from the menu on the left.

**PUBLICATIONS**

[SBIR/STTR Advantage](#)  
[Innovation Stories](#)  
[Transition Stories](#)

1  
2  
3

**Exhibit 11** - IDS From Duggan Provisional Application

No. 60/480,192





IFW

IN THE UNITED STATES PATENT AND TRADEMARK OFFICE

First Named Inventor : Dave Duggan et al.

Appln. No. : 60/480,192

Filed : June 20, 2003

For : METHOD AND APPARATUS FOR AUTONOMOUS AND SEMI-AUTONOMOUS COMMAND AND CONTROL OF UNMANNED AIR VEHICLE

Docket No.: G46.12-0001

Group Art Unit: ---

Examiner: ---

INFORMATION DISCLOSURE STATEMENT

Commissioner for Patents P.O. Box 1450 Alexandria, VA 22313-1450

I HEREBY CERTIFY THAT THIS PAPER IS BEING SENT BY U.S. MAIL, FIRST CLASS, TO THE COMMISSIONER FOR PATENTS, P.O. BOX 1450, ALEXANDRIA, VA 22313-1450, THIS

29th DAY OF July 2007 Christopher L. Hall PATENT ATTORNEY

Sir:

The patents or publications listed on the enclosed PTO Form-1449 are submitted pursuant to 37 C.F.R. § 1.97. Copies of the patents or publications cited are enclosed.

TIME OF FILING

The information disclosure statement is being filed:

- 1. X with the application or within three months of the filing date of the application or date of entry into the national stage of an international application or before the mailing date of a first Office action on the merits, whichever event occurs last. In accordance with 37 C.F.R. § 1.97(b), no statement or fee is required.
2. after the time period specified in paragraph 1 above, but before the mailing date of a final action under 37 C.F.R. § 1.113 or notice of allowance under 37 C.F.R. § 1.311. Therefore, in accordance with 37 C.F.R. § 1.97(c), submitted herewith is:
(check either A or B below)
A. a statement as specified in 37 C.F.R. § 1.97(e).

-2-

- B.  the fee set forth in 37 C.F.R. § 1.17(p) for submission of an information disclosure statement under 37 C.F.R. § 1.97(c).
  
- 3.  after the mailing date of either a final action under 37 C.F.R. § 1.113 or a notice of allowance under 37 C.F.R. § 1.311, whichever occurs first, but before payment of the issue fee. Therefore, Applicant petitions for consideration and submits herewith:
  - A. a statement as specified in 37 C.F.R. § 1.97(e);
  - B. the petition fee set forth in 37 C.F.R. § 1.17(p).

**STATEMENT**

(only used if No. 2(A) or No. 3 above is checked)

The person(s) signing below certify

(check appropriate paragraph)

that each item of information contained in this Information Disclosure Statement was first cited in any communication from a foreign patent office in a counterpart foreign application not more than three months prior to the filing of this statement. 37 C.F.R. § 1.97(e)(1).

OR

that no item of information contained in this Information Disclosure Statement was cited in a communication from a foreign patent office in a counterpart foreign application or, to the knowledge of the person signing the certification after making reasonable inquiry, was known to any individual designated in 37 C.F.R. § 1.56(c) more than three months prior to the filing of this statement. 37 C.F.R. § 1.97(e)(2).

**METHOD OF PAYMENT**

No fee is required.

Attached is a check in the amount of \$\_\_\_\_\_.

-3-

The Director is authorized to charge any fee deficiency required by this paper or credit any overpayment to Deposit Account No. 23-1123. A duplicate copy of this communication is enclosed.

Respectfully submitted,

WESTMAN, CHAMPLIN & KELLY, P.A.

By: Christopher L. Holt  
Christopher L. Holt, Reg. No. 45,844  
Suite 1600 - International Centre  
900 Second Avenue South  
Minneapolis, Minnesota 55402-3319  
Phone: (612) 334-3222  
Fax: (612) 334-3312

CLH/rkp



FORM PTO-1449	Atty. Docket No.: G46.12-0001	Appl. No.: 10/871,612
LIST OF PATENTS AND PUBLICATIONS FOR APPLICANT'S INFORMATION DISCLOSURE STATEMENT	First Named Inventor:	
	Dave Duggan et al.	
	Filing Date	Group Art:
	June 18, 2004	---

U.S. PATENT DOCUMENTS

Examiner Initial	Document No.	Date	Name	Class	Sub Class	Filing Date If Appropriate
AA	5,214,584	05/1993	Dingee et al.	364	423	
AB	5,123,610	06/1992	Oaks	244	3.12	
AC	4,611,771	09/1986	Gibbons et al.	244	3.12	
AD	4,725,956	02/1988	Jenkins	364	434	
AE	5,522,567	06/1996	Kinstler	244	3.15	
AF	5,904,724	05/1999	Margolin	701	120	
AG	4,848,755	09/1989	McNulty et al.	364	434	
AH	4,642,774	02/1987	Centala et al.	364	434	
AI	5,951,609	09/1999	Hanson et al.	701	13	
AJ	5,951,607	09/1999	Senn et al.	701	1	
AK	5,944,762	08/1999	Bessacini et al.	701	27	

FOREIGN PATENT DOCUMENTS

	Document No.	Date	Country	Class	Sub Class	Translation Yes No
AL						
AM						
AN						

OTHER ART (Including Author, Title, Date, Pertinent Pages, Etc.)

AO	
AP	
AQ	

EXAMINER:	DATE CONSIDERED:
-----------	------------------

EXAMINER: Initial if citation considered, whether or not citation is in conformance with MPEP 609; draw line through citation if not in conformance and not considered. Include copy of this form with next communication to applicant.



FORM PTO-1449	Atty. Docket No.: G46.12-0001	Appl. No.: 10/871,612
LIST OF PATENTS AND PUBLICATIONS FOR APPLICANT'S INFORMATION DISCLOSURE STATEMENT	First Named Inventor:	
	Dave Duggan et al.	
	Filing Date	Group Art:
	June 18, 2004	---

U.S. PATENT DOCUMENTS

Examiner Initial	Document No.	Date	Name	Class	Sub Class	Filing Date If Appropriate
AR	5,822,515	10/1998	Baylocq	395	185.09	
AS	5,782,429	07/1998	Mead	244	3.11	
AT	5,691,531	11/1997	Harris et al.	244	3.14	
AU	5,048,771	09/1991	Siering	244	3.15	
AV	5,042,743	08/1991	Edwin R. Carney	244	3.11	
AW	5,240,207	08/1993	Eiband et al.	244	190	
AX	5,938,148	08/1999	Orenstein	244	3.15	
AY	5,552,983	09/1996	Thornberg et al.	364	424.01	
AZ	5,181,673	01/1993	Hubricht et al.	244	3.12	
BA	5,605,307	02/1997	Batchman et al.	244	3.11	
BB						

FOREIGN PATENT DOCUMENTS

	Document No.	Date	Country	Class	Sub Class	Translation Yes No
BC						
BD						
BE						

OTHER ART (Including Author, Title, Date, Pertinent Pages, Etc.)

BF	
BG	
BH	

EXAMINER:

DATE CONSIDERED:

EXAMINER: Initial if citation considered, whether or not citation is in conformance with MPEP 609; draw line through citation if not in conformance and not considered. Include copy of this form with next communication to applicant.

# Exhibit 6

# Exhibit 6



UNITED STATES PATENT AND TRADEMARK OFFICE

UNITED STATES DEPARTMENT OF COMMERCE  
United States Patent and Trademark Office  
Address: COMMISSIONER FOR PATENTS  
P.O. Box 1450  
Alexandria, Virginia 22313-1450  
www.uspto.gov

APPLICATION NO.	FILING DATE	FIRST NAMED INVENTOR	ATTORNEY DOCKET NO.	CONFIRMATION NO.
11/736,356	04/17/2007	Jed Margolin		3649
23497	7590	02/15/2011	EXAMINER	
JED MARGOLIN 1981 EMPIRE ROAD RENO, NV 89521-7430			MANCHO, RONNIE M	
			ART UNIT	PAPER NUMBER
			3664	
			MAIL DATE	DELIVERY MODE
			02/15/2011	PAPER

**Please find below and/or attached an Office communication concerning this application or proceeding.**

The time period for reply, if any, is set in the attached communication.

**Office Action Summary**

<b>Application No.</b> 11/736,356	<b>Applicant(s)</b> MARGOLIN, JED	
<b>Examiner</b> RONNIE MANCHO	<b>Art Unit</b> 3664	

-- The MAILING DATE of this communication appears on the cover sheet with the correspondence address --

**Period for Reply**

A SHORTENED STATUTORY PERIOD FOR REPLY IS SET TO EXPIRE 3 MONTH(S) OR THIRTY (30) DAYS, WHICHEVER IS LONGER, FROM THE MAILING DATE OF THIS COMMUNICATION.

- Extensions of time may be available under the provisions of 37 CFR 1.136(a). In no event, however, may a reply be timely filed after SIX (6) MONTHS from the mailing date of this communication.
- If NO period for reply is specified above, the maximum statutory period will apply and will expire SIX (6) MONTHS from the mailing date of this communication.
- Failure to reply within the set or extended period for reply will, by statute, cause the application to become ABANDONED (35 U.S.C. § 133). Any reply received by the Office later than three months after the mailing date of this communication, even if timely filed, may reduce any earned patent term adjustment. See 37 CFR 1.704(b).

**Status**

- 1)  Responsive to communication(s) filed on 11/29/10.
- 2a)  This action is **FINAL**.
- 2b)  This action is non-final.
- 3)  Since this application is in condition for allowance except for formal matters, prosecution as to the merits is closed in accordance with the practice under *Ex parte Quayle*, 1935 C.D. 11, 453 O.G. 213.

**Disposition of Claims**

- 4)  Claim(s) 1-14 is/are pending in the application.  
4a) Of the above claim(s) \_\_\_\_\_ is/are withdrawn from consideration.
- 5)  Claim(s) \_\_\_\_\_ is/are allowed.
- 6)  Claim(s) 1-14 is/are rejected.
- 7)  Claim(s) \_\_\_\_\_ is/are objected to.
- 8)  Claim(s) \_\_\_\_\_ are subject to restriction and/or election requirement.

**Application Papers**

- 9)  The specification is objected to by the Examiner.
- 10)  The drawing(s) filed on \_\_\_\_\_ is/are: a)  accepted or b)  objected to by the Examiner.  
Applicant may not request that any objection to the drawing(s) be held in abeyance. See 37 CFR 1.85(a).  
Replacement drawing sheet(s) including the correction is required if the drawing(s) is objected to. See 37 CFR 1.121(d).
- 11)  The oath or declaration is objected to by the Examiner. Note the attached Office Action or form PTO-152.

**Priority under 35 U.S.C. § 119**

- 12)  Acknowledgment is made of a claim for foreign priority under 35 U.S.C. § 119(a)-(d) or (f).  
a)  All    b)  Some \*    c)  None of:  
1.  Certified copies of the priority documents have been received.  
2.  Certified copies of the priority documents have been received in Application No. \_\_\_\_\_.  
3.  Copies of the certified copies of the priority documents have been received in this National Stage application from the International Bureau (PCT Rule 17.2(a)).

\* See the attached detailed Office action for a list of the certified copies not received.

**Attachment(s)**

- 1)  Notice of References Cited (PTO-892)
- 2)  Notice of Draftsperson's Patent Drawing Review (PTO-948)
- 3)  Information Disclosure Statement(s) (PTO/SB/08)  
Paper No(s)/Mail Date \_\_\_\_\_.
- 4)  Interview Summary (PTO-413)  
Paper No(s)/Mail Date \_\_\_\_\_.
- 5)  Notice of Informal Patent Application
- 6)  Other: \_\_\_\_\_.



Art Unit: 3664

## DETAILED ACTION

### Claim Rejections - 35 USC § 103

1. The following is a quotation of 35 U.S.C. 103(a) which forms the basis for all obviousness rejections set forth in this Office action:

(a) A patent may not be obtained though the invention is not identically disclosed or described as set forth in section 102 of this title, if the differences between the subject matter sought to be patented and the prior art are such that the subject matter as a whole would have been obvious at the time the invention was made to a person having ordinary skill in the art to which said subject matter pertains. Patentability shall not be negated by the manner in which the invention was made.

2. Claims 1-14 are rejected under 35 U.S.C. 103(a) as being unpatentable over Margolin (5904724) in view of Duggan et al (US 2005004723).

Regarding claim 1, Margolin (abstract; figs. 1-7; col. 3, lines 8-67; col. 4, lines 1-67; col. 5, lines 1-67) discloses a system for safely flying an unmanned aerial vehicle in civilian airspace comprising:

(a) a ground station 400 (fig. 1&4) equipped with a synthetic vision system (figs. 1&3; col. 5, lines 50-60; col. 4, lines 1 to col. 5, lines 67);

(b) an unmanned aerial vehicle 300 (figs. 1&3) capable of supporting said synthetic vision system (305, 306, 307, 311 on aircraft; col. 5, lines 50-60; col. 3, lines 8-67; col. 4, lines 1-67; col. 5, lines 1-67);

(c) a remote pilot 102 operating said ground station 400 (figs. 1&4; col. 3, lines 8-67; col. 4, lines 1-67; col. 5, lines 1-67);

(d) a communications link between said unmanned aerial vehicle 300 and said ground station 400;

Art Unit: 3664

e) a system onboard said unmanned aerial vehicle 300 for detecting the presence and position of nearby aircraft (305, 306, 307, 311 on aircraft) and communicating this information to said remote pilot 102 (col. 3, lines 8-67; col. 4, lines 1-67; col. 5, lines 1-67);

whereas said remote pilot uses said synthetic vision system (305, 306, 307, 311 on aircraft; col. 5, lines 50-60) to control said unmanned aerial vehicle 300 during at least selected phases of the flight of said unmanned aerial vehicle (selected phases implies some or all phases during flight).

Margolin did not disclose that the vehicle is flown using an autonomous control system (e.g. autopilot). However, Duggan teach of a system for safely flying an unmanned aerial vehicle in civilian airspace comprising:

a ground station controlling an unmanned aerial vehicle (sec. 0352, 00353), wherein during phases of a flight of an unmanned aerial vehicle (UAV, sec 0318, 0322, 0353) when a synthetic vision (sec. 0356, 0365, 0388, 0390) is not used to control said unmanned aerial vehicle said unmanned aerial vehicle is flown using an autonomous control system (autopilot, sec 0346 to 0350, 0390-0329).

Therefore, it would have been obvious to one of ordinary skill in the art at the time the invention was made to modify Margolin as taught by Duggan for the purpose of incorporating an autopilot to ensure smooth transitions (Duggan abstract, sec 0014, 0085, 0086).

The different embodiments in both prior arts are combinable as it would be obvious to one having ordinary skill in the art.

Art Unit: 3664

Regarding claim 2, Margolin (abstract; figs. 1-7; col. 3, lines 8-67; col. 4, lines 1-67; col. 5, lines 1-67) in view of Duggan disclose the system of claim 1 whereby said selected phases of the flight of said unmanned aerial vehicle comprise:

(a) when said unmanned aerial vehicle is within a selected range of an airport or other designated location and is below a first specified altitude;

(b) when said unmanned aerial vehicle is outside said selected range of an airport or other designated location and is below a second specified altitude.

Regarding claim 3, Margolin (abstract; figs. 1-7; col. 3, lines 8-67; col. 4, lines 1-67; col. 5, lines 1-67) in view of Duggan disclose the system of claim 1 further comprising a system onboard said unmanned aerial vehicle for periodically transmitting the identification, location, altitude, and bearing of said unmanned aerial vehicle.

Regarding claim 4, Margolin (abstract; figs. 1-7; col. 3, lines 8-67; col. 4, lines 1-67; col. 5, lines 1-67) in view of Duggan disclose the system of claim 1 further comprising a system onboard said unmanned aerial vehicle for providing a communications channel for Air Traffic Control and the pilots of other aircraft to communicate directly with said remote pilot.

Regarding claim 5, Margolin (abstract; figs. 1-7; col. 3, lines 8-67; col. 4, lines 1-67; col. 5, lines 1-67) in view of Duggan disclose a system for safely flying an unmanned aerial vehicle in civilian airspace comprising:

(a) a ground station equipped with a synthetic vision system;

(b) an unmanned aerial vehicle capable of supporting said synthetic vision system;

(c) a remote pilot operating said ground station;

(d) a communications link between said unmanned aerial vehicle and said ground station;

Art Unit: 3664

e) a system onboard said unmanned aerial vehicle for detecting the presence and position of nearby aircraft and communicating this information to said remote pilot;

whereas said remote pilot uses said synthetic vision system to control said unmanned aerial vehicle during at least selected phases of the flight of said unmanned aerial vehicle, and during those phases of the flight of said unmanned aerial vehicle when said synthetic vision system is not used to control said unmanned aerial vehicle said unmanned aerial vehicle is flown using an autonomous control system, and

whereas the selected phases of the flight of said unmanned aerial vehicle comprise:

(a) when said unmanned aerial vehicle is within a selected range of an airport or other designated location and is below a first specified altitude;

(b) when said unmanned aerial vehicle is outside said selected range of an airport or other designated location and is below a second specified altitude.

Margolin did not disclose that the vehicle is flown using an autonomous control system. However, Duggan teach of a system for safely flying an unmanned aerial vehicle in civilian airspace comprising:

a ground station controlling an unmanned aerial vehicle (sec. 0352, 00353), wherein during phases of a flight of an unmanned aerial vehicle (UAV, sec 0318, 0322, 0353) when a synthetic vision (sec. 0356, 0365, 0388, 0390) is not used to control said unmanned aerial vehicle said unmanned aerial vehicle is flown using an autonomous control system (autopilot, sec 0346 to 0350, 0390-0329).

Art Unit: 3664

Therefore, it would have been obvious to one of ordinary skill in the art at the time the invention was made to modify Margolin as taught by Duggan for the purpose of incorporating an autopilot to ensure smooth transitions (Duggan abstract, sec 0014, 0085, 0086).

The different embodiments in both prior arts are combinable as it would be obvious to one having ordinary skill in the art.

Regarding claim 6, Margolin (abstract; figs. 1-7; col. 3, lines 8-67; col. 4, lines 1-67; col. 5, lines 1-67) in view of Duggan disclose the system of claim 5 further comprising a system onboard said unmanned aerial vehicle for periodically transmitting the identification, location, altitude, and bearing of said unmanned aerial vehicle.

Regarding claim 7, Margolin (abstract; figs. 1-7; col. 3, lines 8-67; col. 4, lines 1-67; col. 5, lines 1-67) in view of Duggan disclose the system of claim 5 further comprising a system onboard said unmanned aerial vehicle for providing a communications channel for Air Traffic Control and the pilots of other aircraft to communicate directly with said remote pilot.

Regarding claim 8, Margolin (abstract; figs. 1-7; col. 3, lines 8-67; col. 4, lines 1-67; col. 5, lines 1-67) in view of Duggan disclose a method for safely flying an unmanned aerial vehicle as part of a unmanned aerial system equipped with a synthetic vision system in civilian airspace comprising the steps of:

(a) using a remote pilot to fly said unmanned aerial vehicle using synthetic vision during at least selected phases of the flight of said unmanned aerial vehicle, and during those phases of the flight of said unmanned aerial vehicle when said synthetic vision system is not used to control said unmanned aerial vehicle an autonomous control system is used to fly said unmanned aerial vehicle;

Art Unit: 3664

(b) providing a system onboard said unmanned aerial vehicle for detecting the presence and position of nearby aircraft and communicating this information to said remote pilot.

Margolin did not disclose that the vehicle is flown using an autonomous control system. However, Duggan teach of a system for safely flying an unmanned aerial vehicle in civilian airspace comprising:

a ground station controlling an unmanned aerial vehicle (sec. 0352, 00353), wherein during phases of a flight of an unmanned aerial vehicle (UAV, sec 0318, 0322, 0353) when a synthetic vision (sec. 0356, 0365, 0388, 0390) is not used to control said unmanned aerial vehicle said unmanned aerial vehicle is flown using an autonomous control system (autopilot, sec 0346 to 0350, 0390-0329).

Therefore, it would have been obvious to one of ordinary skill in the art at the time the invention was made to modify Margolin as taught by Duggan for the purpose of incorporating an autopilot to ensure smooth transitions (Duggan abstract, sec 0014, 0085, 0086).

The different embodiments in both prior arts are combinable as it would be obvious to one having ordinary skill in the art.

Regarding claim 9, Margolin (abstract; figs. 1-7; col. 3, lines 8-67; col. 4, lines 1-67; col. 5, lines 1-67) in view of Duggan disclose the method of claim 8 whereby said selected phases of the flight of said unmanned aerial vehicle comprise:

(a) when said unmanned aerial vehicle is within a selected range of an airport or other designated location and is below a first specified altitude;

(b) when said unmanned aerial vehicle is outside said selected range of an airport or other designated location and is below a second specified altitude.

Art Unit: 3664

Regarding claim 10, Margolin (abstract; figs. 1-7; col. 3, lines 8-67; col. 4, lines 1-67; col. 5, lines 1-67) in view of Duggan disclose the method of claim 8 further comprising the step of providing a system onboard said unmanned aerial vehicle for periodically transmitting the identification, location, altitude, and bearing of said unmanned aerial vehicle.

Regarding claim 11, Margolin (abstract; figs. 1-7; col. 3, lines 8-67; col. 4, lines 1-67; col. 5, lines 1-67) in view of Duggan disclose the method of claim 8 further comprising the step of providing a system onboard said unmanned aerial vehicle for providing a communications channel for Air Traffic Control and the pilots of other aircraft to communicate directly with said remote pilot.

Regarding claim 12, Margolin (abstract; figs. 1-7; col. 3, lines 8-67; col. 4, lines 1-67; col. 5, lines 1-67) in view of Duggan disclose a method for safely flying an unmanned aerial vehicle as part of a unmanned aerial system equipped with a synthetic vision system in civilian airspace comprising the steps of:

(a) using a remote pilot to fly said unmanned aerial vehicle using synthetic vision during at least selected phases of the flight of said unmanned aerial vehicle, and during those phases of the flight of said unmanned aerial vehicle when said synthetic vision system is not used to control said unmanned aerial vehicle an autonomous control system is used to fly said unmanned aerial vehicle;

(b) providing a system onboard said unmanned aerial vehicle for detecting the presence and position of nearby aircraft and communicating this information to said remote pilot;

whereas said selected phases of the flight of said unmanned aerial vehicle comprise:

Art Unit: 3664

(a) when said unmanned aerial vehicle is within a selected range of an airport or other designated location and is below a first specified altitude;

(b) when said unmanned aerial vehicle is outside said selected range of an airport or other designated location and is below a second specified altitude.

Margolin did not disclose that the vehicle is flown using an autonomous control system. However, Duggan teach of a system for safely flying an unmanned aerial vehicle in civilian airspace comprising:

a ground station controlling an unmanned aerial vehicle (sec. 0352, 00353), wherein during phases of a flight of an unmanned aerial vehicle (UAV, sec 0318, 0322, 0353) when a synthetic vision (sec. 0356, 0365, 0388, 0390) is not used to control said unmanned aerial vehicle said unmanned aerial vehicle is flown using an autonomous control system (autopilot, sec 0346 to 0350, 0390-0329).

Therefore, it would have been obvious to one of ordinary skill in the art at the time the invention was made to modify Margolin as taught by Duggan for the purpose of incorporating an autopilot to ensure smooth transitions (Duggna abstract, sec 0014, 0085, 0086).

The different embodiments in both prior arts are combinable as it would be obvious to one having ordinary skill in the art.

Regarding claim 13, Margolin (abstract; figs. 1-7; col. 3, lines 8-67; col. 4, lines 1-67; col. 5, lines 1-67) in view of Duggan disclose the method of claim 12 further comprising the step of providing a system onboard said unmanned aerial vehicle for periodically transmitting the identification, location, altitude, and bearing of said unmanned aerial vehicle.



Art Unit: 3664

Regarding claim 14, Margolin (abstract; figs. 1-7; col. 3, lines 8-67; col. 4, lines 1-67; col. 5, lines 1-67) in view of Duggan disclose the method of claim 12 further comprising the step of providing a system onboard said unmanned aerial vehicle for providing a communications channel for Air Traffic Control and the pilots of other aircraft to communicate directly with said remote pilot.

### **Response to Arguments**

3. Applicant's arguments filed 11/29/10 have been fully considered but they are not persuasive.

Applicant's specification is ONLY 16 pages long. However, applicant has provided an affidavit and remarks that are over 200 pages. The affidavits are referring to paying rents and mortgages, etc. The examiner does not understand how paying rents and mortgages are related to the present invention drawn to flying an un-manned aerial vehicle.

Applicant further argues that Margolin belongs to the inventor. It is noted that the prior art is a statutory bar since it was published more than 8 years before filing of the present application.

Applicant further argues that the prior art do not disclose flying an unmanned aerial vehicle (i.e. an aircraft) in civilian airspace. The examiner does not acquiesce to applicant's remarks. The prior art clearly shows flying an unmanned aerial vehicle (i.e. an aircraft) in civilian airspace since the air space in which the vehicle is flown is not restricted. As further noted applicant fails to provide a particular meaning attached to "civilian airspace".

Art Unit: 3664

Applicant further argues that both prior art do not disclose “a synthetic vision system”. The examiner disagrees. It appears that applicant is insisting that the prior art must recite the exact same terms as disclosed in the claims. Applicant first of all does not present an argument which first provide the meaning of the claimed “synthetic vision system”. As disclosed in applicant's specification the claimed, “a synthetic vision system” is referring to 3-D vision. The prior art disclose 3-D presentation of image to a pilot (here a remote pilot) thus the prior art anticipates the claimed, “a synthetic vision system”.

Applicant further argues about the abstract cited in the prior. The purpose of the argument is not understood since applicant is arguing that the popular interpretation of 608.01 (b) is that the purpose of the abstract is to provide search terms. It is unclear whether “popular” refers to the manner abstracts are interpreted in Florida, Washington, or somewhere else. Abstracts are not excluded during the examination process.

Some of applicant’s remarks are that the prior art does not recite the phrase, “safely flying an unmanned aerial vehicle in civilian airspace comprising: ...”. Applicant thus insists that the rejection is conclusory and is not supported. The examiner disagrees and notes that any particular level of safety is not described or disclosed in the specification nor is there any meaning provided for “ civilian airspace” or “safety”. It is believed that the aircraft flown in the prior art is flown safely and further that the aircraft is flown in all airspaces since a particular airspace was not prohibited.

Applicant continues that the examiner fails to address all of the recitations of the rejected claims. The examiner disagrees and notes that the prior art anticipates all limitations in the

Art Unit: 3664

claims. There is not rule in MPEP that insist that the prior must recite the terms in the claims exactly as they are disclosed in the claims.

4. Claims 1-14 are rejected under 35 U.S.C. 103(a) as being unpatentable over Margolin (5904724) in view of Duggan et al (US 2005004723).

Margolin (abstract; figs. 1-7; col. 3, lines 8-67; col. 4, lines 1-67; col. 5, lines 1-67) discloses a system for safely flying an unmanned aerial vehicle in civilian airspace comprising:

(a) a ground station 400 (fig. 1&4) equipped with a synthetic vision system (figs. 1&3; col. 5, lines 50-60; col. 4, lines 1 to col. 5, lines 67);

(b) an unmanned aerial vehicle 300 (figs. 1&3) capable of supporting said synthetic vision system (305, 306, 307, 311 on aircraft; col. 5, lines 50-60; col. 3, lines 8-67; col. 4, lines 1-67; col. 5, lines 1-67);

(c) a remote pilot 102 operating said ground station 400 (figs. 1&4; col. 3, lines 8-67; col. 4, lines 1-67; col. 5, lines 1-67);

(d) a communications link between said unmanned aerial vehicle 300 and said ground station 400;

e) a system onboard said unmanned aerial vehicle 300 for detecting the presence and position of nearby aircraft (305, 306, 307, 311 on aircraft) and communicating this information to said remote pilot 102 (col. 3, lines 8-67; col. 4, lines 1-67; col. 5, lines 1-67);

whereas said remote pilot uses said synthetic vision system (305, 306, 307, 311 on aircraft) to control said unmanned aerial vehicle 300 during at least selected phases of the flight of said unmanned aerial vehicle.

Art Unit: 3664

Margolin did not disclose that the vehicle is flown using an autonomous control system (e.g. an autopilot). However, Duggan teach of a system for safely flying an unmanned aerial vehicle in civilian airspace comprising:

a ground station controlling an unmanned aerial vehicle (sec. 0352, 00353), wherein during phases of a flight of an unmanned aerial vehicle (UAV, sec 0318, 0322, 0353) when a synthetic vision (sec. 0356, 0365, 0388, 0390) is not used to control said unmanned aerial vehicle said unmanned aerial vehicle is flown using an autonomous control system (autopilot, sec 0346 to 0350, 0390-0329).

Therefore, it would have been obvious to one of ordinary skill in the art at the time the invention was made to modify Margolin as taught by Duggan for the purpose of incorporating an autopilot to ensure smooth transitions (Duggan abstract, sec 0014, 0085, 0086).

The different embodiments in both prior arts are combinable as it would be obvious to one having ordinary skill in the art.

It is believed that the rejection is proper and thus shall stand. Applicant may file an RCE, Appeal to the Board, or abandon the case.

### **Conclusion**

5. **THIS ACTION IS MADE FINAL.** Applicant is reminded of the extension of time policy as set forth in 37 CFR 1.136(a).

A shortened statutory period for reply to this final action is set to expire THREE MONTHS from the mailing date of this action. In the event a first reply is filed within TWO MONTHS of the mailing date of this final action and the advisory action is not mailed until after

Art Unit: 3664

the end of the THREE-MONTH shortened statutory period, then the shortened statutory period will expire on the date the advisory action is mailed, and any extension fee pursuant to 37 CFR 1.136(a) will be calculated from the mailing date of the advisory action. In no event, however, will the statutory period for reply expire later than SIX MONTHS from the mailing date of this final action.

### **Communication**

6. Any inquiry concerning this communication or earlier communications from the examiner should be directed to RONNIE MANCHO whose telephone number is (571)272-6984. The examiner can normally be reached on Mon-Thurs: 9-5.

If attempts to reach the examiner by telephone are unsuccessful, the examiner's supervisor, Tran Khoi can be reached on 571-272-6919. The fax phone number for the organization where this application or proceeding is assigned is 571-273-8300.

Information regarding the status of an application may be obtained from the Patent Application Information Retrieval (PAIR) system. Status information for published applications may be obtained from either Private PAIR or Public PAIR. Status information for unpublished applications is available through Private PAIR only. For more information about the PAIR system, see <http://pair-direct.uspto.gov>. Should you have questions on access to the Private PAIR system, contact the Electronic Business Center (EBC) at 866-217-9197 (toll-free). If you would like assistance from a USPTO Customer Service Representative or access to the automated information system, call 800-786-9199 (IN USA OR CANADA) or 571-272-1000.

Application/Control Number: 11/736,356

Page 15

Art Unit: 3664

/Ronnie Mancho/  
Primary Examiner, Art Unit 3664

/Ronnie Mancho/  
Primary Examiner, Art Unit 3664

# Exhibit 7

# Exhibit 7

IN THE UNITED STATES PATENT AND TRADEMARK OFFICE

In re Application of Jed Margolin

Serial No.: 11/736,356

Examiner: Ronnie M. Mancho

Filed: 4/17/2007

Art Unit: 3664

For: **System and Method For Safely Flying Unmanned Aerial Vehicles in Civilian Airspace**

Filed: 4/17/2007  
First Office Action: 9/1/2010  
Response: 11/29/2010  
Second Office Action: 2/15/2011

The following is to comply with 37 CFR § 1.133 **Interviews** and MPEP Section 713.04  
**Substance of Interview Must Be Made of Record.**

I called the Examiner on or about March 2, 2011. I identified myself and the patent application and asked the Examiner to withdraw making the Second Office Action Final.

He asked for my reason.

I said I wanted the opportunity to respond to the additional grounds for rejection he had made in the Second Office Action (which he had made Final).

He said that the First Office Action had been sent to me and I had had the opportunity to respond, and he believed I did.

I repeated that he had made additional grounds for rejection in the Second Office Action and I wanted the opportunity to respond.

He looked up the case and cited the 103 basis for rejection: Margolin (5,904,724) and Duggan (Published Application US 2005004723).

I told him that I am that Margolin.



I also told him that he had done a cut-and-paste of the rejection in the First Office Action but had added a few things.

He wanted to know where.

I pointed out First Office Action (page 3, third paragraph):

*Margolin did not disclose that the vehicle is flown using an autonomous control system. However, Duggan teach of a system for safely flying an unmanned aerial vehicle in civilian airspace comprising:*

In the Second Office Action it became (page 3, third paragraph):

Margolin did not disclose that the vehicle is flown using an autonomous control system (e.g. autopilot). However, Duggan teach of a system for safely flying an unmanned aerial vehicle in civilian airspace comprising:

I said that he had equated autonomous control system with an autopilot, but they are not the same.

He believed the rejection was still the same and offered a long explanation that did not make much sense. I did hear him say that he believed I did not understand the term “autopilot.”

We moved on to his statement in the Second Office Action about civilian airspace (page 10, last line), where he said:

Applicant further argues that the prior art do not disclose flying an unmanned aerial vehicle (i.e. an aircraft) in civilian airspace. The examiner does not acquiesce to applicant's remarks. The prior art clearly shows flying an unmanned aerial vehicle (i.e. an aircraft) in civilian airspace since the air space in which the vehicle is flown is not restricted. As further noted applicant fails to provide a particular meaning attached to "civilian airspace".

I told him that “civilian airspace” was term commonly used in the aerospace community and that FAA and the military use it. I referred him to my reference **Sensing Requirements for Unmanned Air Vehicles** which contains the passage:

Engineers from the Air Vehicles Directorate transferred unmanned air vehicle (UAV) sensing system requirements for airspace operations to civilian UAV users and developers. These requirements represent design goals on which to base future sensing subsystem designs, filling an omission in UAV technology planning. Directorate engineers are continuing to develop the technologies that will enable future UAVs to coexist with manned aircraft in both military and civilian airspace. Incorporating these

requirements will ensure that engineers design future UAVs to detect possible conflicts, such as midair collisions or runway incursions, and take action to avoid them.

He said that I had used the term but did not define it.

I said that, although I was entitled to be my own lexicographer, I was not required to be one, and I had the right to use the common meaning of terms.

He said that I still had to provide the meaning of the term, and I hadn't.

I said he could have made that rejection in the First Office Action, when I would have had the opportunity to respond to it. Instead, by introducing it in the Second Office Action he had denied me the opportunity to respond.

We moved on to his use of my own patent against me. I reminded him that I had protested his use of my own patent against me in my Response to the First Office Action.

Applicant argued that Margolin belongs to the inventor. It is noted that the prior art is a statutory bar since it was published more than 8 years before filing of the present application.

I asked him where the 8 years comes from because I had not found it in MPEP or the U.S. Code. He said 8 years was longer than 1 year and referred me to 102(b).

Then he asked if I was a patent attorney. Since I am not, I said no. Then he suggested I get a patent attorney.

To get back to the issue at hand I read 102(b) to him and told him that it does not apply because the present invention is not the same as the one described in '724. It is a new application for '724.

At that point the Examiner was confused as to whether I was Margolin or Duggan.

{The problem is not, as he implied, that I don't know anything about patent law. The problem is that I cannot read his mind or sometimes, understand his English.}

We moved on. I explained why I had discussed the Duggan application in such detail, starting with the fact that it had issued as a patent (U.S. Patent 7,343,232 **Vehicle control system including related methods and components**) on March 11, 2008, before the First Office

Action. I also explained why I had introduced the extensive exhibit concerning the financial problems experienced by the Duggan Examiner. I explained that when I stated in my Response to the First Office Action that “Perhaps the Duggan Examiner was preoccupied with financial problems” I was being diplomatic. In fact, the evidence shows that the Duggan Examiner was either incompetent or may have committed misconduct. I explained to the Examiner that my reason for bringing up the subject was to show that the USPTO Office discriminates against *pro se* inventors. Aerospace Companies with expensive Law Firms are given a free pass, while *pro se* inventors get kicked in the head. I was not asking for a free pass, only to be treated fairly.

The telephone interview between the Examiner and myself that is described above was cordial but the Examiner refused to withdraw making the Second Office Action Final. Indeed, the Examiner displayed the USPTO’s bias against *pro se* inventors.

Respectfully submitted,

/Jed Margolin/

Date: April 10, 2010

Jed Margolin

Jed Margolin  
1981 Empire Rd.  
Reno, NV 89521-7430  
(775) 847-7845

# Exhibit 8

# Exhibit 8

IN THE UNITED STATES PATENT AND TRADEMARK OFFICE

In re Application of Jed Margolin

Serial No.: 11/736,356

Examiner: Ronnie M. Mancho

Filed: 4/17/2007

Art Unit: 3664

For: **System and Method For Safely Flying Unmanned Aerial Vehicles in Civilian Airspace**

Filed: 4/17/2007  
First Office Action: 9/1/2010  
Response: 11/29/2010  
Second Office Action: 2/15/2011

The following is to comply with 37 CFR § 1.133 **Interviews** and MPEP Section 713.04  
**Substance of Interview Must Be Made of Record.**

I called SPE Tran Khoi on or about March 22, 2011. Mr. Khoi is the SPE for the Examiner in this application. I identified myself and the patent application and explained to SPE Khoi that his Examiner had expanded his grounds for rejection in the Second Office Action, which constructively added new grounds for rejection, and had made the rejection final. I asked SPE Khoi to ask the Examiner to withdraw making the Second Office Action Final so I could respond to the new rejection and introduce new evidence.

SPE Khoi asked if I had amended the claims. I said no.

He asked if I was an attorney. I said no, I am a *pro se* applicant but I have done this before.

Then he asked for the Application Number and I gave it to him.

After he looked it up he asked where the Examiner had given new grounds for rejection.

I started with where the Examiner had equated an Autopilot with an Autonomous Control System.

Then I pointed out where the Examiner had introduce the issue of Civilian Airspace, and that he could have done that in the First Office Action but hadn't.

I brought up the issue of the Duggan Examiner and that her actions in the Duggan patent constitute either incompetence or possible misconduct. I explained that the reason I had brought up this issue was to show that the USPTO discriminates against *pro se* inventors. Aerospace companies with expensive Law Firms are given a free pass, while *pro se* inventors get kicked in the head. I was not asking for a free pass, only fair treatment.

I brought up the issue of the Examiner citing my own patent (5,904,724) against me, and that it was not proper under 102(b) because the present invention is not taught by '724, it is a new application of '724.

We discussed the issue of Civilian Airspace again.

Then I brought up the issue of the Examiner's statement about safety. In the Second Office Action he had made the statement (page 11, third paragraph):

Applicant thus insists that the rejection is conclusory and is not supported. The examiner disagrees and notes that any particular level of safety is not described or disclosed in the specification nor is there any meaning provided for "civilian airspace" or "safety". **It is believed that the aircraft flown in the prior art is flown safely and further that the aircraft is flown in all airspaces since a particular airspace was not prohibited.**

I explained that the Examiner's belief is absolutely wrong and that safely flying UAVs is a major problem. I went into some detail.

SPE Khoi distinguished the section in the Second Office Action "Response to Arguments" with the Formal Rejection in "Claim Rejections" and stated that "Response to Arguments" was not subject to Rule 706.07(a).

I said that the Examiner's Response to Arguments will be used against me at BPAI and I deserve the right to respond to it and introduce new evidence.

SPE Khoi suggested I file a Petition. I told him that filing a Petition does not toll deadlines and that I have heard of the USPTO simply waiting for the deadline to pass and then saying the Petition is moot.

After that the conversation deteriorated and will not be summarized here.

Then we talked about the current state of UAV technology and what my invention actually is.

SPE Khoi said he would look at my case and get back to me.

A few days later, on or about March 24, 2001, SPE Khoi left me message saying that the Examiner's Final Office Action was correct and proper.

The telephone interview between SPE Khoi and myself that is described above was mostly cordial but SPE Khoi decided that the Examiner's Final Office Action was correct and proper. And then he advised me to "Have a Nice Day."

Respectfully submitted,

/Jed Margolin/            Date: April 10, 2010

Jed Margolin

Jed Margolin  
1981 Empire Rd.  
Reno, NV 89521-7430  
(775) 847-7845

# Exhibit 9

# Exhibit 9



Under the Paperwork Reduction Act of 1995, no persons are required to respond to a collection of information unless it contains a valid OMB control number.

Substitute for form 1449A/PTO  <b>INFORMATION DISCLOSURE STATEMENT BY APPLICANT</b>  (Use as many sheets as necessary)	<b>Complete if Known</b> Application Number Filing Date First Named Inventor <b>Jed Margolin</b> Art Unit Examiner Name Attorney Docket Number
Sheet <b>1</b> of <b>3</b>	

U. S. PATENT DOCUMENTS					
Examiner Initials*	Cite No. <sup>1</sup>	Document Number Number-Kind Code <sup>2</sup> (if known)	Publication Date MM-DD-YYYY	Name of Patentee or Applicant of Cited Document	Pages, Columns, Lines, Where Relevant Passages or Relevant Figures Appear
		US- 5,153,836	10-06-1992	Fraughton, et al.	
		US- 5,187,485	02-16-1993	Tsui, et al.	
		US- 5,904,724	05-18-1999	Margolin	
		US- Publication Number 20060174221	08-03-2006	Kinsella, et al.	Paragraphs 0018, 0019, and 0042
		US-			
		US-			
		US-			
		US-			
		US-			
		US-			
		US-			
		US-			
		US-			
		US-			
		US-			
		US-			
		US-			
		US-			
		US-			
		US-			
		US-			

FOREIGN PATENT DOCUMENTS						
Examiner Initials*	Cite No. <sup>1</sup>	Foreign Patent Document Country Code <sup>3</sup> -Number <sup>4</sup> Kind Code <sup>5</sup> (if known)	Publication Date MM-DD-YYYY	Name of Patentee or Applicant of Cited Document	Pages, Columns, Lines, Where Relevant Passages or Relevant Figures Appear	T <sup>6</sup>

Examiner Signature	/Ronnie Mancho/ (08/28/2010)	Date Considered	
--------------------	------------------------------	-----------------	--

\*EXAMINER: Initial if reference considered, whether or not citation is in conformance with MPEP 609. Draw line through citation if not in conformance and not considered. Include copy of this form with next communication to applicant. 1 Applicant's unique citation designation number (optional). 2 See Kinds Codes of USPTO Patent Documents at [www.uspto.gov](http://www.uspto.gov) or MPEP 901.04. 3 Enter Office that issued the document, by the two-letter code (WIPO Standard ST.3). 4 For Japanese patent documents, the indication of the year of the reign of the Emperor must precede the serial number of the patent document. 5 Kind of document by the appropriate symbols as indicated on the document under WIPO Standard ST.16 if possible. 6 Applicant is to place a check mark here if English language Translation is attached.

This collection of information is required by 37 CFR 1.97 and 1.98. The information is required to obtain or retain a benefit by the public which is to file (and by the USPTO to process) an application. Confidentiality is governed by 35 U.S.C. 122 and 37 CFR 1.14. This collection is estimated to take 2 hours to complete, including gathering, preparing, and submitting the completed application form to the USPTO. Time will vary depending upon the individual case. Any comments on the amount of time you require to complete this form and/or suggestions for reducing this burden, should be sent to the Chief Information Officer, U.S. Patent and Trademark Office, U.S. Department of Commerce, P.O. Box 1450, Alexandria, VA 22313-1450. DO NOT SEND FEES OR COMPLETED FORMS TO THIS ADDRESS. SEND TO: **Commissioner for Patents, P.O. Box 1450, Alexandria, VA 22313-1450.**

If you need assistance in completing the form, call 1-800-PTO-9199 and select option 2.

Under the Paperwork Reduction Act of 1995, no persons are required to respond to a collection of information unless it contains a valid OMB control number.

Substitute for form 1449B/PTO			<b>Complete if Known</b>		
<b>INFORMATION DISCLOSURE STATEMENT BY APPLICANT</b>			Application Number		
			Filing Date		
			First Named Inventor		<b>Jed Margolin</b>
			Art Unit		
			Examiner Name		
			Attorney Docket Number		
Sheet	<b>2</b>	of	<b>3</b>		
<i>(Use as many sheets as necessary)</i>					

NON PATENT LITERATURE DOCUMENTS			
Examiner Initials*	Cite No. <sup>1</sup>	Include name of the author (in CAPITAL LETTERS), title of the article (when appropriate), title of the item (book, magazine, journal, serial, symposium, catalog, etc.), date, page(s), volume-issue number(s), publisher, city and/or country where published.	T <sup>2</sup>
		<b>Sensing Requirements for Unmanned Air Vehicles</b> , AFRL's Air Vehicles Directorate, Control Sciences Division, Systems Development Branch, Wright-Patterson AFB OH, June 2004, <a href="http://www.afrlhorizons.com/Briefs/Jun04/VA0306.html">www.afrlhorizons.com/Briefs/Jun04/VA0306.html</a>	
		Presentation: <b>Developing Sense &amp; Avoid Requirements for Meeting an Equivalent Level of Safety</b> given by RUSS WOLFE, Technology IPT Lead, Access 5 Project at UVS Tech 2006. (January 18, 2006)	
		Presentation: <b>Integration into the National Airspace System (NAS)</b> given by JOHN TIMMERMAN of the FAA's Air Traffic Organization (July 12, 2005)	
		<b>Zone Ready for Drone</b> , April 7, 2006 on the web site for the FAA's Air Traffic Organization Employees, <a href="http://www.ato.faa.gov/DesktopDefault.aspx?tabindex=4&amp;tabid=17&amp;itemid=937&amp;mid=103">www.ato.faa.gov/DesktopDefault.aspx?tabindex=4&amp;tabid=17&amp;itemid=937&amp;mid=103</a>	
		<b>Virtual Cockpit Window for a Windowless Aerospacecraft</b> NASA Tech Brief, January 2003 page 40. <a href="http://www.nasatech.com/Briefs/Jan03/MS23096.html">www.nasatech.com/Briefs/Jan03/MS23096.html</a>	
		Press Release from Rapid Imaging Software, Inc. <a href="http://www.landform.com/pages/PressReleases.htm">www.landform.com/pages/PressReleases.htm</a> <b>"On December 13th, 2001, Astronaut Ken Ham successfully flew the X-38 from a remote cockpit ..."</b>	

Examiner Signature	/Ronnie Mancho/ (08/30/2010)	Date Considered	
-----------------------	------------------------------	--------------------	--

\*EXAMINER: Initial if reference considered, whether or not citation is in conformance with MPEP 609. Draw line through citation if not in conformance and not considered. Include copy of this form with next communication to applicant.

<sup>1</sup> Applicant's unique citation designation number (optional). <sup>2</sup> Applicant is to place a check mark here if English language Translation is attached.

This collection of information is required by 37 CFR 1.97 and 1.98. The information is required to obtain or retain a benefit by the public which is to file (and by the USPTO to process) an application. Confidentiality is governed by 35 U.S.C. 122 and 37 CFR 1.14. This collection is estimated to take 2 hours to complete, including gathering, preparing, and submitting the completed application form to the USPTO. Time will vary depending upon the individual case. Any comments on the amount of time you require to complete this form and/or suggestions for reducing this burden, should be sent to the Chief Information Officer, U.S. Patent and Trademark Office, U.S. Department of Commerce, P.O. Box 1450, Alexandria, VA 22313-1450. DO NOT SEND FEES OR COMPLETED FORMS TO THIS ADDRESS. SEND TO: **Commissioner for Patents, P.O. Box 1450, Alexandria, VA 22313-1450.**

If you need assistance in completing the form, call 1-800-PTO-9199 and select option 2.

Under the Paperwork Reduction Act of 1995, no persons are required to respond to a collection of information unless it contains a valid OMB control number.

Substitute for form 1449B/PTO			<b>Complete if Known</b>	
<b>INFORMATION DISCLOSURE STATEMENT BY APPLICANT</b>			Application Number	
			Filing Date	
			First Named Inventor	
			Art Unit	
			Examiner Name	
(Use as many sheets as necessary)			Jed Margolin	
Sheet	3	of	3	Attorney Docket Number

NON PATENT LITERATURE DOCUMENTS			
Examiner Initials*	Cite No. <sup>1</sup>	Include name of the author (in CAPITAL LETTERS), title of the article (when appropriate), title of the item (book, magazine, journal, serial, symposium, catalog, etc.), date, page(s), volume-issue number(s), publisher, city and/or country where published.	T <sup>2</sup>
		Article: <b>Flying UAVs in Civil Airspace By Using Synthetic Vision</b> JED MARGOLIN, <a href="http://www.jmargolin.com/todo/uavs.htm">www.jmargolin.com/todo/uavs.htm</a>	
		NTSB Incident Report on crash of Predator on April 25, 2006, northwest of Nogales, NM. NTSB Identification <b>CHI06MA121</b>	
		<b>Lockheed's Polecats UCAV Demonstrator Crashes</b> Aviation Week & Space Technology, AMY BUTLER, 03/19/2007, page 44	
		<b>The F-22 Continues to Encounter</b> Aviation Week & Space Technology, 02/26/2007, page 18	
		<b>Gulf of Mexico Helo Ops Ready for ADS-B</b> Aviation Week & Space Technology, FRANCES FIORINO, 02/26/2007, page 56	
		<b>Embedded Experts: Fix code bugs or cost lives</b> , RICK MERIT, EE Times, 04/10/2006 <a href="http://www.eetimes.com/showArticle.jhtml?articleID=184429901">www.eetimes.com/showArticle.jhtml?articleID=184429901</a>	
		<b>Entries from the Software Failure Hall of Shame, Part 1</b> , TOM RHINELANDER, July 06, 2006, <a href="http://www.g2zero.com/2006/07/notable_entries_from_the_softw_1.html">www.g2zero.com/2006/07/notable_entries_from_the_softw_1.html</a>	
		<b>Hardware-in-the-Loop Simulation</b> , MARTIN GOMEZ, Embedded Systems Design, 11/30/01, <a href="http://www.embedded.com/showArticle.jhtml?articleID=15201692">www.embedded.com/showArticle.jhtml?articleID=15201692</a>	
		<b>Supreme Court Decision</b> , Boyle v. United Technologies Corp., <b>487 U.S. 500 (1988)</b>	
		<b>Basic Concepts of real-time operating systems</b> , DAVID KALINSKY (Nov. 18, 2003) <a href="http://linuxdevices.com/articles/AT4627965573.html">http://linuxdevices.com/articles/AT4627965573.html</a>	

Examiner Signature	/Ronnie Mancho/ (08/30/2010)	Date Considered	
-----------------------	------------------------------	--------------------	--

\*EXAMINER: Initial if reference considered, whether or not citation is in conformance with MPEP 609. Draw line through citation if not in conformance and not considered. Include copy of this form with next communication to applicant.

<sup>1</sup> Applicant's unique citation designation number (optional). <sup>2</sup> Applicant is to place a check mark here if English language Translation is attached.

This collection of information is required by 37 CFR 1.97 and 1.98. The information is required to obtain or retain a benefit by the public which is to file (and by the USPTO to process) an application. Confidentiality is governed by 35 U.S.C. 122 and 37 CFR 1.14. This collection is estimated to take 2 hours to complete, including gathering, preparing, and submitting the completed application form to the USPTO. Time will vary depending upon the individual case. Any comments on the amount of time you require to complete this form and/or suggestions for reducing this burden, should be sent to the Chief Information Officer, U.S. Patent and Trademark Office, U.S. Department of Commerce, P.O. Box 1450, Alexandria, VA 22313-1450. DO NOT SEND FEES OR COMPLETED FORMS TO THIS ADDRESS. SEND TO: Commissioner for Patents, P.O. Box 1450, Alexandria, VA 22313-1450.

If you need assistance in completing the form, call 1-800-PTO-9199 and select option 2.

# Exhibit 10

# Exhibit 10

# Sensing Requirements for Unmanned Air Vehicles

**Engineers develop requirements and metrics to ensure integration of future autonomous unmanned aircraft into manned airspace.**

***AFRL's Air Vehicles Directorate, Control Sciences Division, Systems Development Branch, Wright-Patterson AFB OH***

Engineers from the Air Vehicles Directorate transferred unmanned air vehicle (UAV) sensing system requirements for airspace operations to civilian UAV users and developers. These requirements represent design goals on which to base future sensing subsystem designs, filling an omission in UAV technology planning. Directorate engineers are continuing to develop the technologies that will enable future UAVs to coexist with manned aircraft in both military and civilian airspace. Incorporating these requirements will ensure that engineers design future UAVs to detect possible conflicts, such as midair collisions or runway incursions, and take action to avoid them.

Present UAVs cannot detect manned aircraft and conflict situations and, therefore, they cannot share airspace with manned aircraft. To overcome this obstacle, UAVs need to sense the presence of other aircraft in their operating environment (see figure on next page). In other words, UAVs need to at least replicate a human pilot's ability to see and avoid problems before they will be accepted into the national air space (NAS). Since some aircraft do not have air traffic transponders, UAVs must use onboard sensors to detect aircraft and coordinate that information with available transponder information. With this level of capability, UAVs and operators will have the situational awareness of the airspace around the vehicle to ensure safety at the same level as manned aircraft.

With this goal in mind, directorate engineers worked with Northrop Grumman Corporation (NGC) engineers to establish, iterate, and finalize sensing system performance requirements for the broad range of future Air Force missions. During this collaborative process, directorate engineers noted that many mission elements were similar to civilian airspace operations tasks, and that the requirements they were developing were directly applicable to civilian UAV technology. They also found no report that defined and expressed these requirements for nonmilitary use. To help fill this void, directorate engineers coordinated their research results with the American Institute for Aeronautics and Astronautics UAV airspace operations' focal point, North Atlantic Treaty Organization's Standards Committees, the National Aeronautics and Space Administration, and industry organizations working the same topics from the civilian side. Incorporation of the directorate's technology into civilian requirements' definitions and standards will directly impact airspace operations' sensing systems for current and future UAVs.

The coordinated effort of directorate and NGC engineers that resulted in the sensing system requirements represents the first stage of work on the Autonomous Flight Control Sensing Technology (AFCST) program. This program's long-term goal is to develop the upfront portion of the UAV virtual pilot capability. During this first phase, NGC engineers analyzed midair and near-midair collision data, along with runway incursion data, to generate lessons learned. Then, the NGC engineers combined the lessons learned from aircraft mishap data with sensing performance specifications and good engineering judgment to establish conventions for operating aircraft in the NAS. Next, they examined

airspace tasks for operation in NAS and grouped them into deconfliction, collision avoidance, autonomous landing, and ground operations. The UAV functional requirements resulting from this effort are shown in the table.

As shown in the table, the threshold values represent the near-term requirements (year 2007), while objective values are far-term requirements (year 2013). Engineers consider the forward vision threshold values equivalent to or slightly better than human performance. Federal Aviation Administration data indicates the dominant cause for mid-air collision is when an aircraft is overtaken by a faster aircraft because a pilot's position in the cockpit limits rear visibility. In the UAV, rear visibility is not restricted because designers can locate sensors anywhere on the aircraft. Objective values contain UAV rear vision capability to improve safety in this scenario.

Directorate and NGC engineers are currently working on the second phase of AFCST—the preliminary design of the sensor hardware architecture. The AFCST design strategy for all UAV situational awareness functions is to minimize hardware and software quantity and maximize use of multifunction sensors and common image processing software components. Most of the design efforts are completed satisfactorily. NGC engineers are continuing detailed sensor reliability analyses, capturing the individual and combined effects of sensor field-of-view coverage, sensor failure rates, and exposure rates.

During the final stage of the AFCST program, engineers will run simulations emphasizing landing and collision avoidance-tasks with demanding sensing and processing requirements. The engineers will develop landing and see-and-avoid strategies of operation as well as a detailed software architecture design. The simulations should determine if the preferred electrooptic/ infrared and radar sensors meet the specifications identified in the first phase of the AFCST program and the number of false alarms and false negatives that will be encountered. The engineers will also compare various image-processing solutions to determine the most reliable. The ideal system design will be free of nuisance faults caused by system error and will include software designed to minimize such faults. Reliability analysis studies will eventually combine software reliabilities with hardware reliabilities to meet the overall UAV system reliability.

In the near future, directorate and NGC engineers plan to publish the results of the detailed sensor reliability analysis. Program managers are also planning a follow-on hardware-in-the-loop simulation effort to address and demonstrate the integrated system design. In this realistic simulation, engineers will study concepts such as the integration of AFCST sensors with instrument flight rules avionics for see-and-avoid maneuvers, landing, and automated traffic collision avoidance. Real-time simulation will stress the detailed sensor architecture design, allowing the engineers to assess its adequacy and determine its readiness for technology transition to flight test. These efforts will ensure the safe incorporation of UAVs into the NAS.

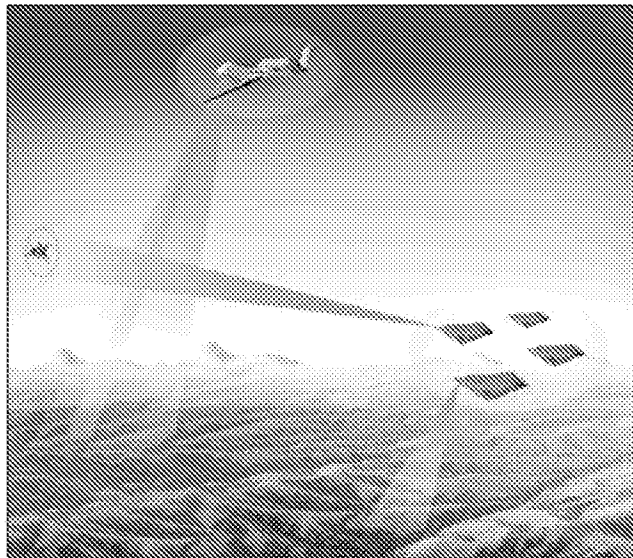

Figure. UAV senses presence of other aircraft

AIRSPACE OPERATIONS SENSING REQUIREMENTS FOR UAVs		
Functional Requirements	Threshold Values	Objective Values
Field of View	Azimuth: 60° Elevation: 30°	4 π steradians
Field of Regard	Azimuth: +/-100° Elevation: +30°, -90°	4 π steradians
Ranging	0.5 ft CEP* @ 100 ft 700 ft CEP* @ 6 nm	0.25 ft CEP* @ 100 ft 770 ft CEP* @ 13.2 nm
Imaging	Varies from 30 ft to 3 nm	Varies from 30 ft to 13.2 nm
Data Rate	30 Hz	60 Hz
Weather Capability	Visual Meteorological Capability	Visual and Instrument Meteorological Capability
Criticality	Safety Critical	Safety Critical
Emission Constraints	Various Federal Aviation Administration Limitations	Various Federal Aviation Administration Limitations
*CEP = circular error probability		

Table. Near- and far-term UAV sensing requirement

Mr. Tom Molnar and Mr. Bruce Clough, of the Air Force Research Laboratory's Air Vehicles Directorate, and Mr. Won-Zon Chen, of Northrop Grumman Corporation, wrote this article. For more information contact TECH CONNECT at (800) 203-6451 or place a request at <http://www.afrl.af.mil/techconn/index.htm>. Reference document VA-03-06

DISTRIBUTION A  
PUBLIC RELEASE

[HOME](#) | [ABOUT AFRL](#) | [CONTACT US](#) | [DISCLAIMER](#)

The information within this website is hosted by ABP International

# Exhibit 11

# Exhibit 11



# Developing Sense & Avoid Requirements for Meeting an Equivalent Level of Safety

UVS Tech 2006  
Salon-de-Provence, France  
17-19 January 2006

Presenter: Russell Wolfe  
Access 5 Technology IPT Lead  
Modern Technology Solutions, Inc

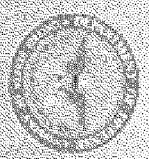
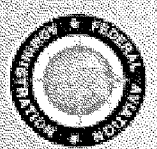
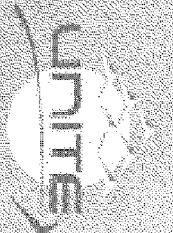
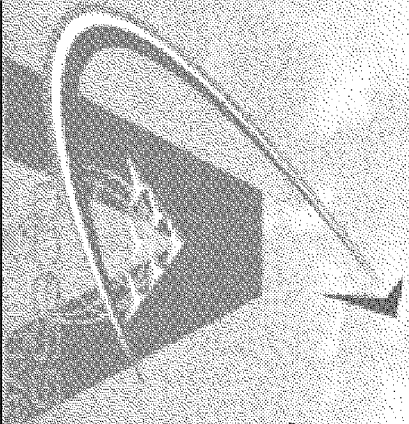

HALE UAS in the NAS

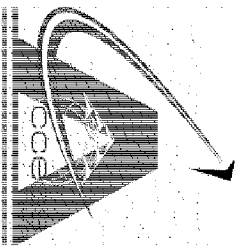

# UAS Collision Avoidance Initiatives

## NASA Dryden Flight Research Center

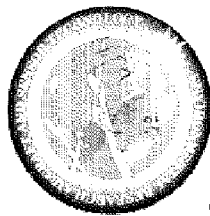

- ERAST: 1993 - 2003
  - Sensor Requirements
  - Sensor Concept Development
  - Flight Test Demonstrations
    - Cooperative
    - EO / IR
    - Radar

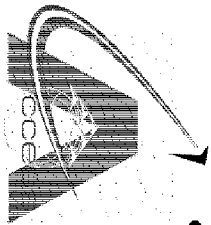

- ACCESS 5: 2004 - present
  - Requirements Development
  - Safety Analysis
  - Simulation Tools
  - Flight Test Demonstrations
  - Standards Development

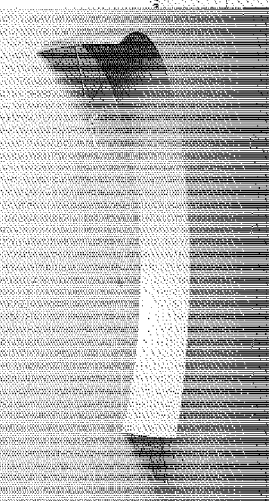
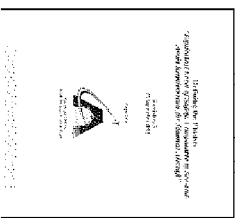
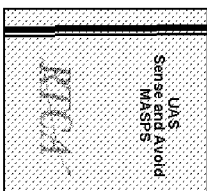
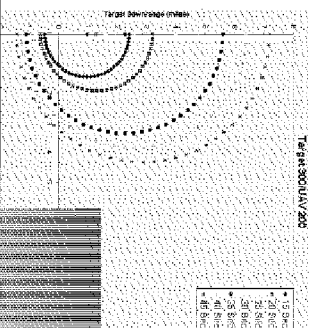
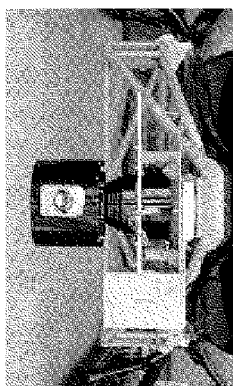
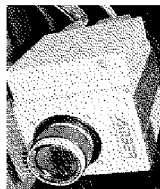

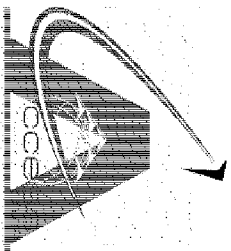

# ACCESS 5 Collision Avoidance Work Package

- **Work Package Objectives:**
  - Define Equivalent Level of Safety (ELOS) for Sense and Avoid.
  - Develop collision avoidance (CA) requirements for Unmanned Aircraft Systems (UAS); validated through analysis, simulation, and flight demonstration.
  - Provide inputs to the FAA and RTCA Special Committee 203 “Unmanned Aircraft Systems”
- **Team Members:**
  - NASA Dryden & Langley
  - Northrop Grumman
  - Lockheed Martin (Ft. Worth)
  - MITRE

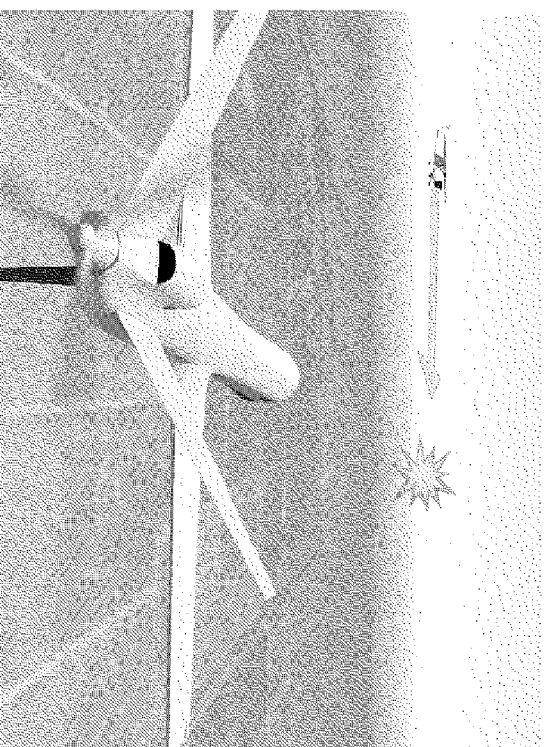

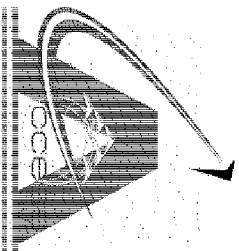

# ACCESS 5 Collision Avoidance Work Package

## 5 Major Task Areas

- CA Task 1:  
**Define ELOS for See & Avoid**

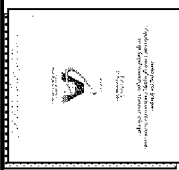

- CA Task 2:  
**Develop CA Requirements**

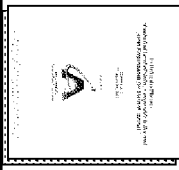

- CA Task 3:  
**Perform CA Safety Analysis**

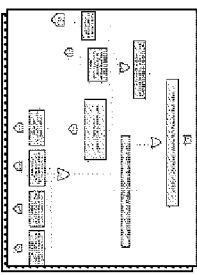

- CA Task 4:  
**Develop CA Simulation Tool**



- CA Task 5:  
**Perform CA Flight Test**



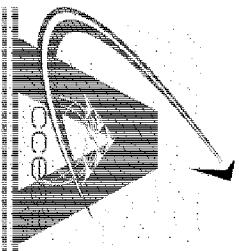

# Collision Avoidance Work Package Task Relationships

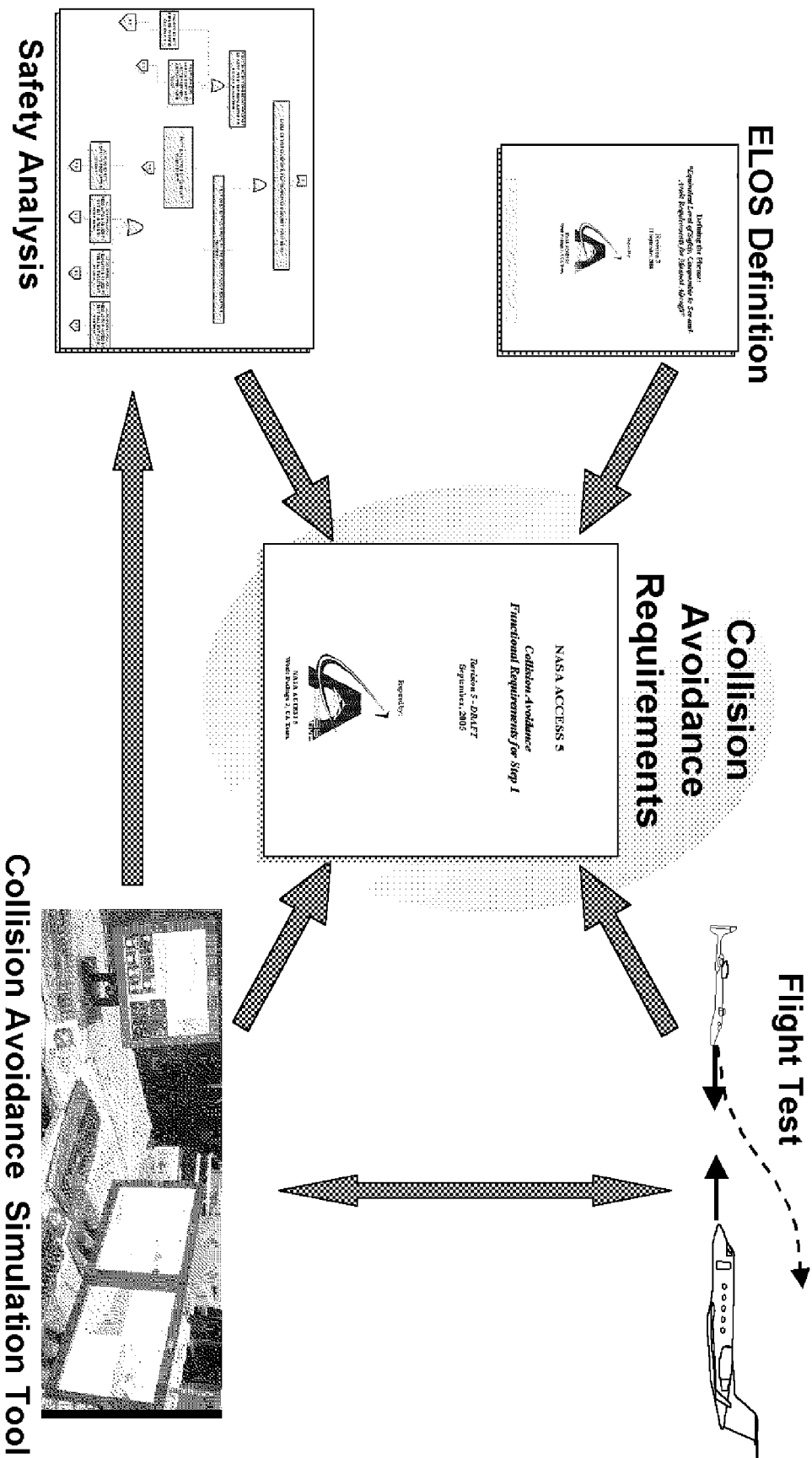

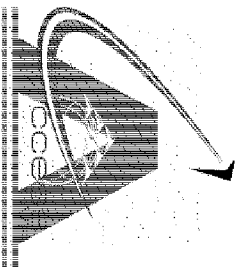

## Task 1: ELOS Definition Document

- **Objective:** To present a recommended approach for defining an equivalent level of safety, as it pertains to see and avoid.
- **Deliverable Content:**
  - Current regulatory / operational environment
    - 14 CFR 91.113(b), Right of Way Rules
    - 14 CFR 91.111, Operating near other aircraft
  - Basis for having to meet an Equivalent Level of Safety
    - 14 CFR 21.21(b), Certification Procedures
    - FAA Order 8110.4C, Equivalent Level of Safety Findings
  - Potential Approaches & Methodologies for defining ELOS
    - 1) Statistical Approach
    - 2) Performance / Rule Based Approach
  - Recommended Definition and Measures of Performance for Sense and Avoid ELOS
- **Status:** Delivered to FAA on 23 Nov 2004

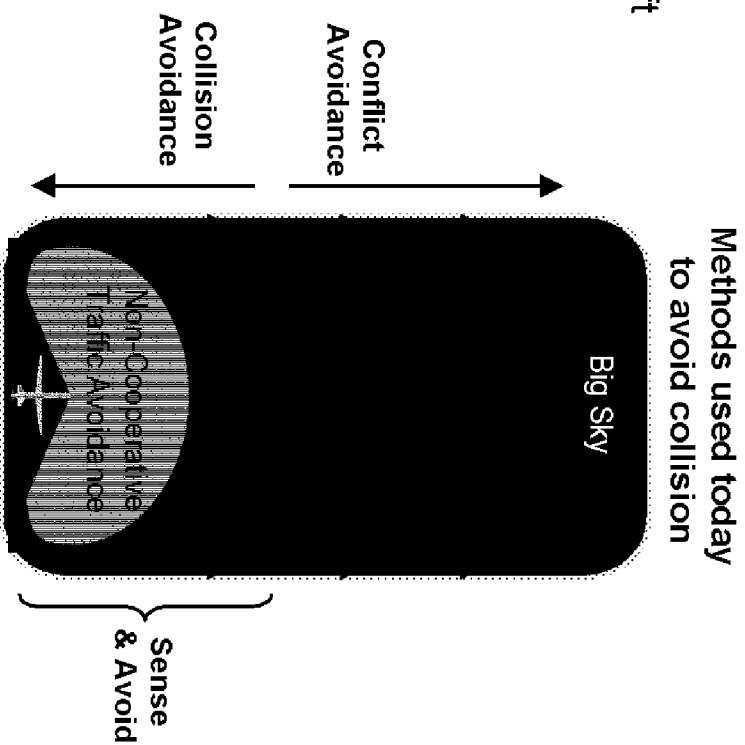

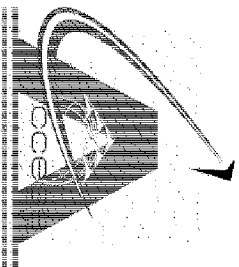

# Task 1: ELOS Definition Document

## Definition and Measures of Performance

- Definition: “Equivalent level of safety to manned aircraft see-and-avoid” is the capability to provide situational awareness with adequate time to detect conflicting traffic and the ability to take the appropriate action necessary to avoid collisions.”

- Measures of Performance:

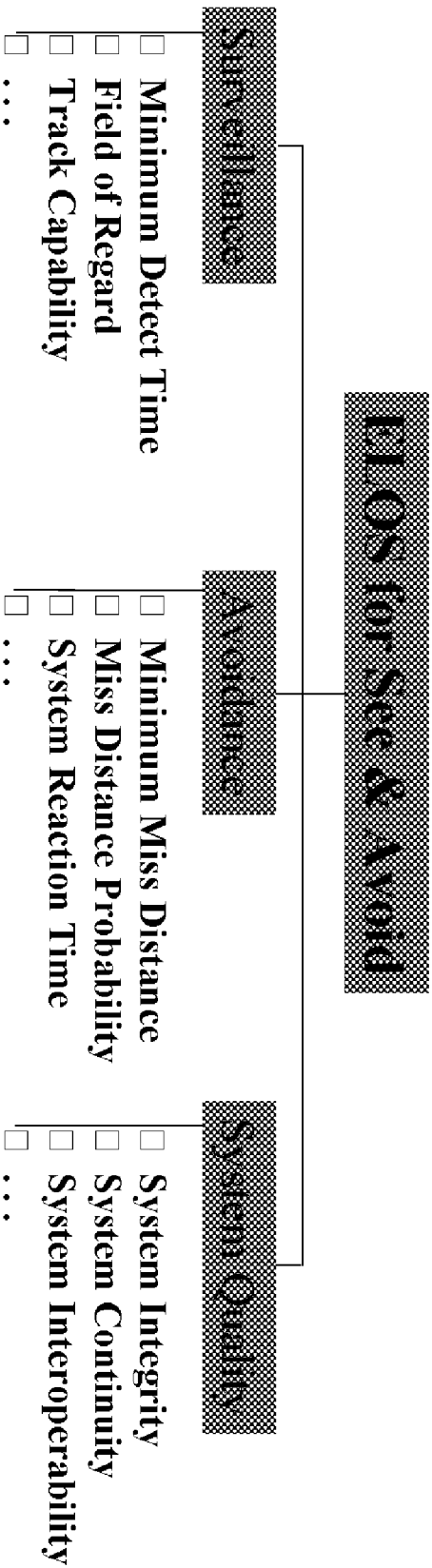

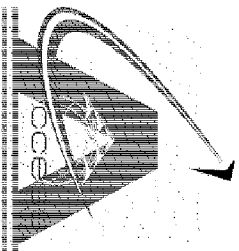

## ***Task 2: Develop Collision Avoidance Reqmts***

- **Objective:** To develop the collision avoidance operational, functional, and performance requirements for HALE UAS.
- **Deliverable Content:**
  - Notional CA Subsystem Description
    - Subsystem Architecture
    - Interfaces
  - Operational Requirements
  - Functional Analysis
    - List of Collision Avoidance Functions
    - Functional Flow Block Diagram
    - Functional Requirements
  - Performance Requirements
    - Design Guidelines
    - Performance Trade-offs
  - Verification Method (Analysis, Inspection, Simulation/Modeling, Demo, Test)
- **Status:** Intend to release Revision 6.0 in February 2006  
(All previous revisions have included FAA input and review)



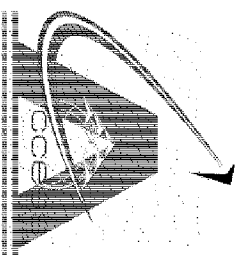

# Task 2: Develop Collision Avoidance Reqmts

## Collision Avoidance Functions

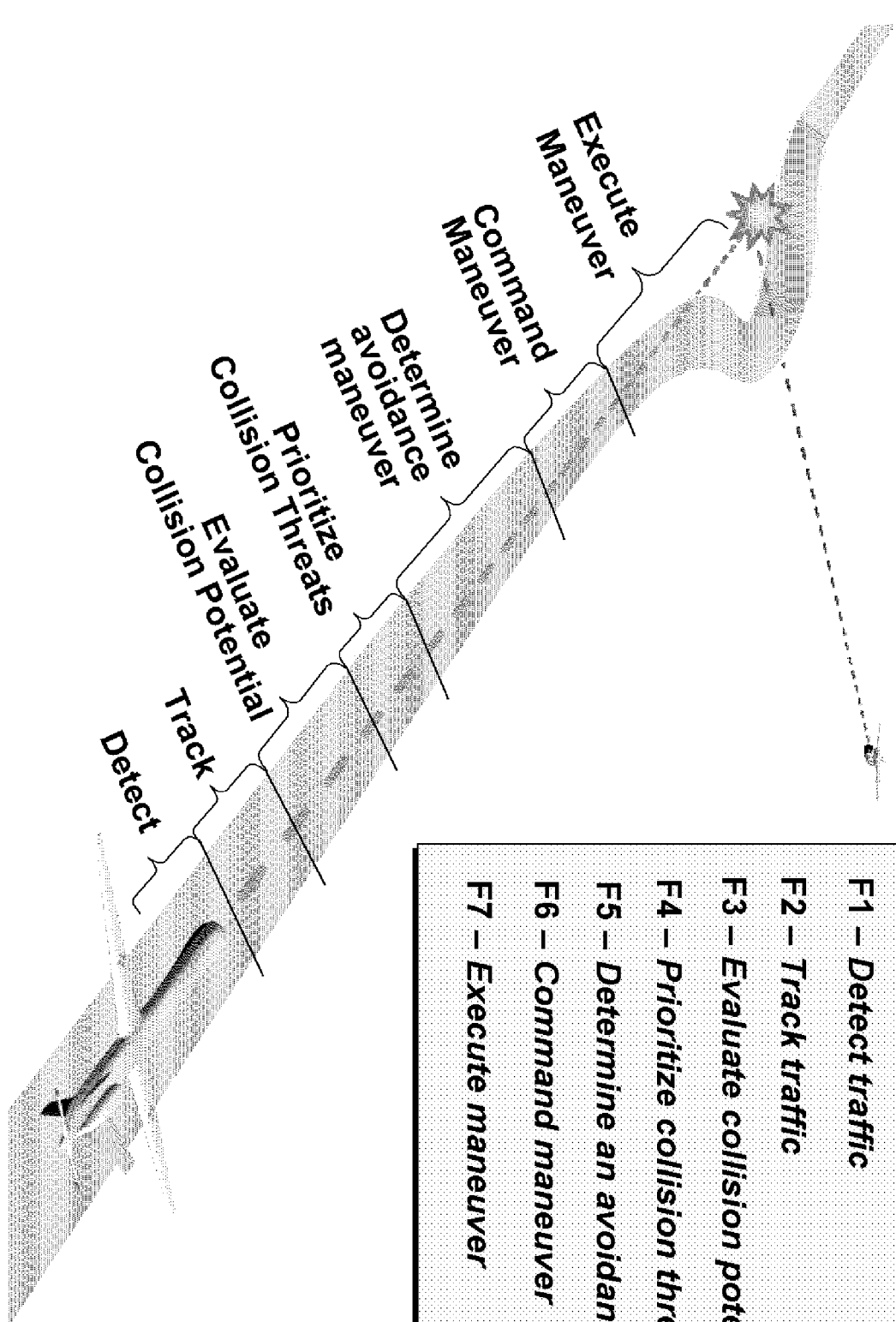

- F1 – Detect traffic
- F2 – Track traffic
- F3 – Evaluate collision potential
- F4 – Prioritize collision threats
- F5 – Determine an avoidance maneuver
- F6 – Command maneuver
- F7 – Execute maneuver

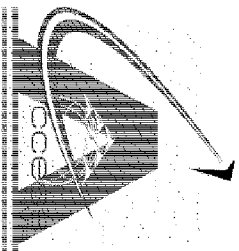

# Task 2: Develop Collision Avoidance Reqmts

## Functional Flow Block Diagram

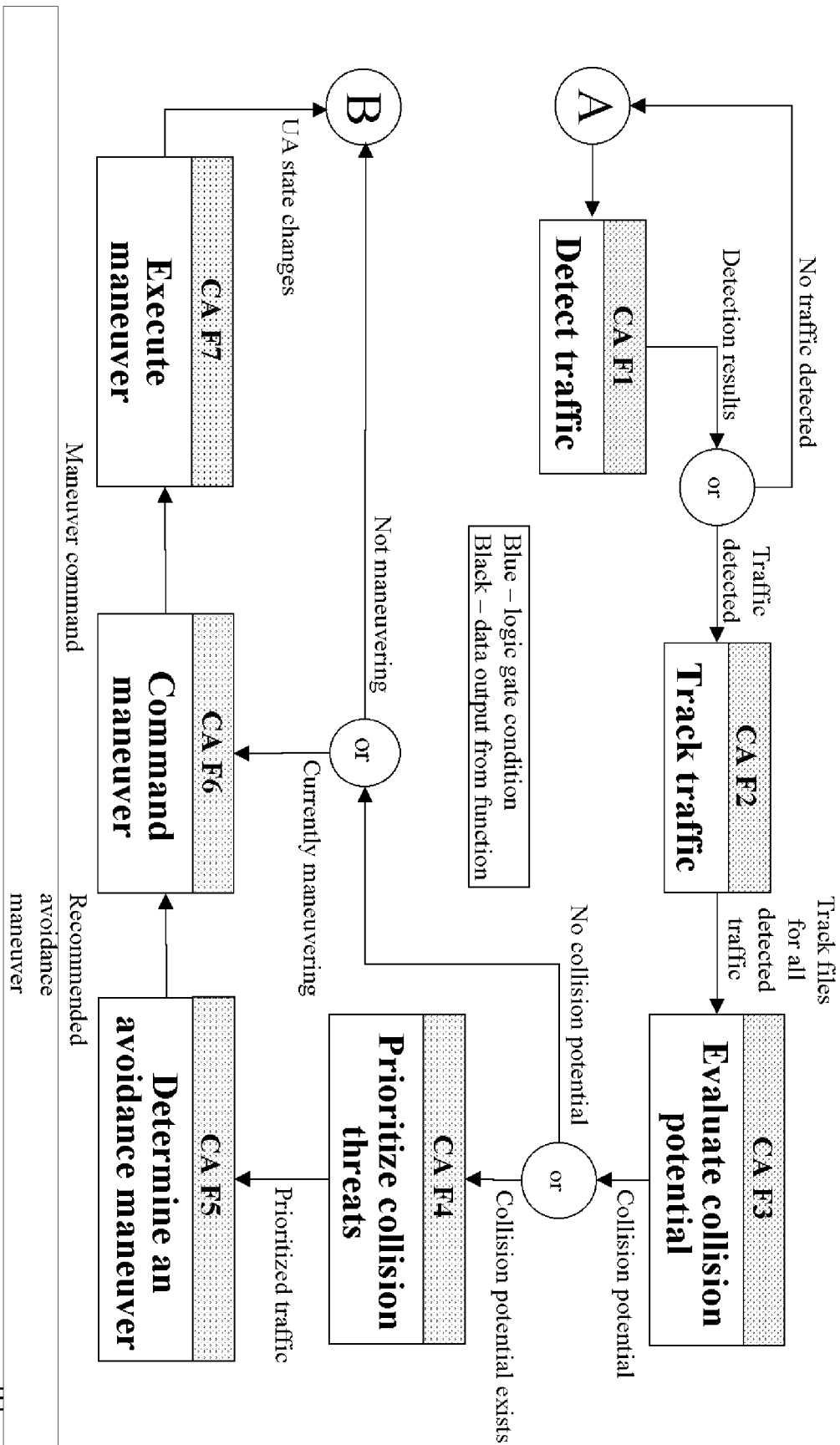

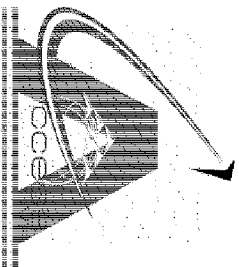

## **Task 2: Develop Collision Avoidance Reqmnts**

### *Function 1: Detect Traffic Requirements (Example)*

- **F1: Detect Traffic - The UAS shall detect traffic within its surveillance volume.**
  - **F1.1: Minimum Detect Time** - The CAS shall detect traffic with sufficient time remaining for successful performance of all required collision avoidance functions.
  - **F1.2: Detection Range** - The CAS shall detect cooperative traffic at a range of at least xx nautical miles. (see *Table F1.2*)
  - **F1.3: Azimuth Field of Regard** - The CAS shall detect cooperative traffic within an azimuth FOR of at least +/-110° referenced from the flight path of the UA.
  - **F1.4: Elevation Field of Regard** - The CAS shall detect cooperative traffic within an elevation FOR of at least +/-15° referenced from the flight path of the UA.
  - **F1.5: Detection Probability** - The CAS shall detect cooperative traffic in the surveillance volume at a rate that supports the track probability guideline (see *F2.3*).
  - **F1.6: Detection Rate** - The average CAS detection rate shall be equal to or greater than xx hertz. (see *Table F1.6*)
  - **F1.7: Detection Accuracy** - The CAS shall detect cooperative traffic with an accuracy of TBD ft for range determinations, and TBD ft for altitude determinations
  - **F1.8: False Detection/Nuisance** - False detections shall account for less than TBD% of all detected traffic.

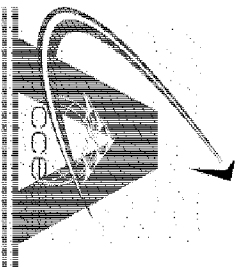

## ***Task 3: Perform Safety Analysis***

- **Objective:** To develop a method for evaluating the safety of collision avoidance for UAS.

- Establish equivalent level of safety to manned aircraft using event/fault trees and logic risk ratios

$$\text{Risk Ratio} = \frac{P(\text{collision UAS})}{P(\text{collision manned AC})} \leq 1$$

- **Accomplishments:**
  - Developed visual acquisition model based on Lincoln Lab's SEE1 model
  - Developed surveillance error models for GPS/ADS-B
  - Performed multiple assessments using results from the CA simulation tool for the primary event tree probabilities.
  - Supported requirements development in the areas of Surveillance, Effectiveness, Detection Accuracies, Detection times, Reaction times, Maneuver times, etc.
- **Status:** Currently finalizing final report and lessons learned

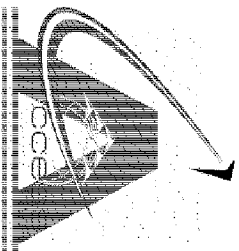

## Task 3: Perform Safety Analysis

### Generic Event/Fault Tree for Collision Probability Estimation

- Generic Event/Fault Tree established to provide a consistent basis for comparison:
  - 1. Manned aircraft using see & avoid
  - 2. Manned aircraft using see & avoid + CAS
  - 3. UAS with Sense & Avoid
  - 4. UAS with Sense & Avoid + CAS

**Simplified Fault Tree** (actual tree is several pages long)

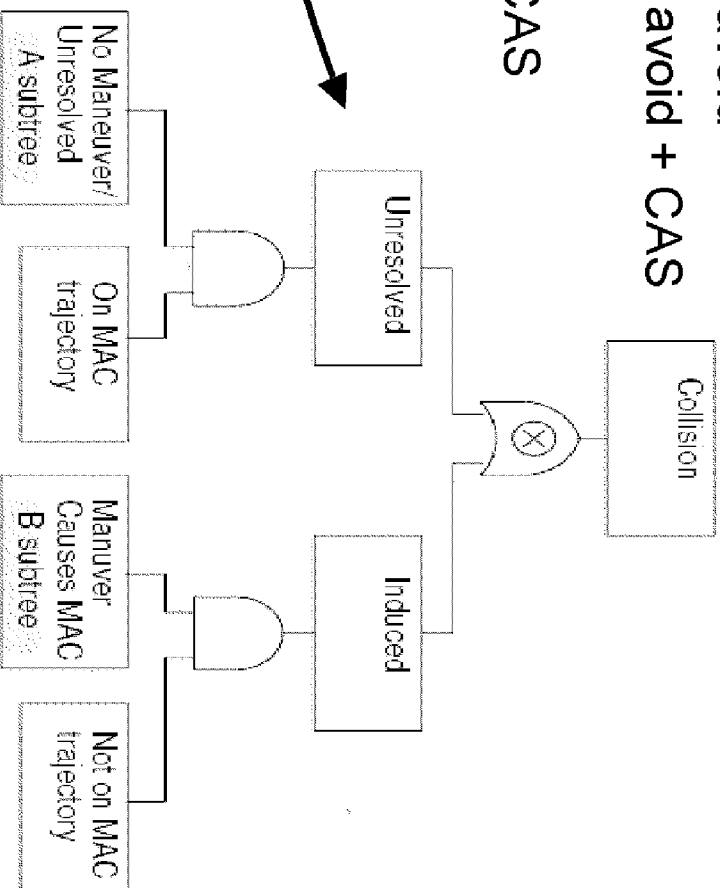

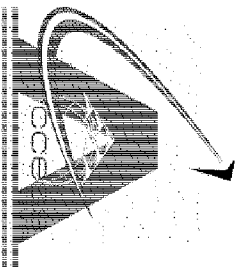

# Task 4: Develop CA Simulation Tool

- **Objective:** To assess the validity of the proposed CA Functional Requirements via Simulation as well as support the CA Flight Test activities.
  - Allows characterization of:
    - Ownship Vehicle Dynamics
    - CA Equipment and Software
    - Encounter Scenarios
- **Accomplishments:**
  - Duplicated Tech Demo Scenarios
    - Flight Test Risk Reduction
    - Improve Probability of Obtaining Useful Data
  - Validated Against the System Integration Lab (SIL)
    - Flight Test Risk Reduction
    - CCA Component Models
  - Sensitivity Analyses performed
- **Status:** Currently analyzing flight test data and validating the CA simulation tool.

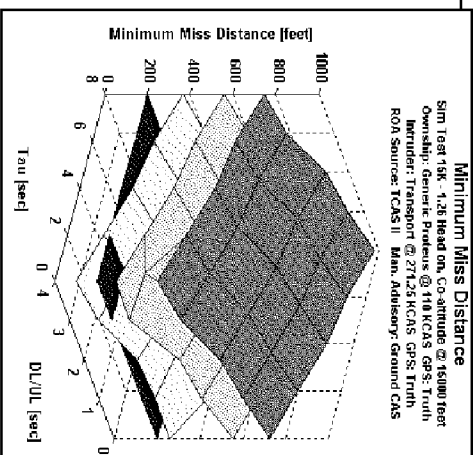
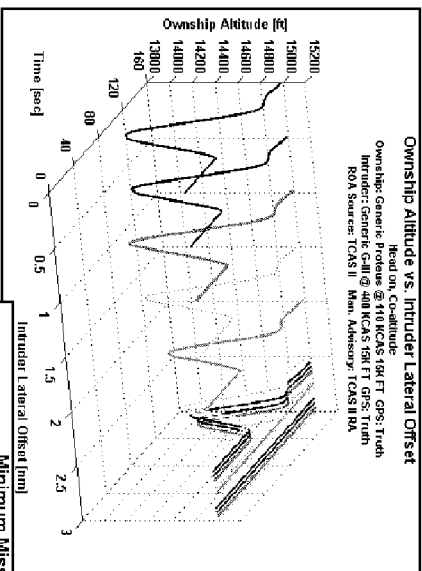

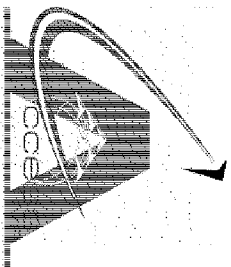

## **Task 4: Develop CA Simulation Tool**

### *Simulation Features*

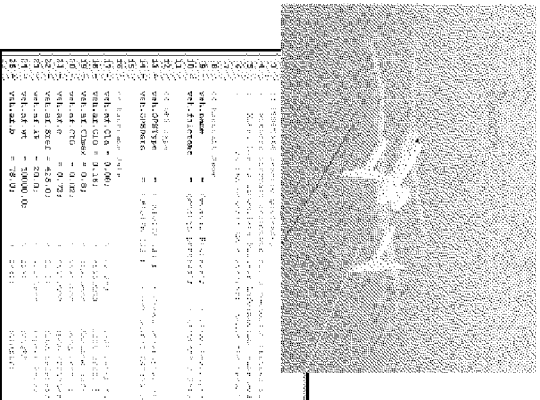
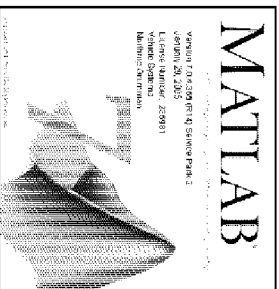

- MATLAB™/Simulink® Simulation Environment
- Multi-Vehicle Simulation (4 Aircraft Max)
- Generic Aircraft Models Represent Any Fixed Wing Aircraft
  - Each Aircraft = 1 Parameter File
  - Scripts Trim & Initialize Aircraft to Any Encounter Geometry
- Modular Components
  - Blocks Can be Copied and/or Swapped Out for Software Upgrades (e.g. CA Sensors, Maneuver Advisory)
- Capable of Batch Runs for Parametric Variation Studies
  - Uses Microsoft Excel Input Dataset
  - Multiple Plot Outputs Available
- PC Portable (< 37 MB)
- Can Run in Both Fast Sim-Time & Soft Real-Time

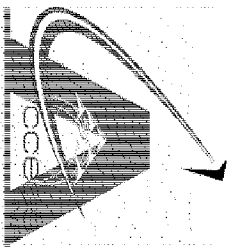

## ***Task 5: Perform CA Flight Test***

- **Objective:** To collect cooperative collision avoidance data to validate the CA simulation tool

- **Accomplishments:**

- Developed Interface Control Document
- Developed System Integration Lab (SIL)
- Developed CA algorithms
- Developed CA software and human interface tool
- Procured CA sensors and integrated them onto Proteus platform
- Developed CA scenarios and test cards
- Post-processed flight data and prepared for data analysis effort

OPV - Proteus

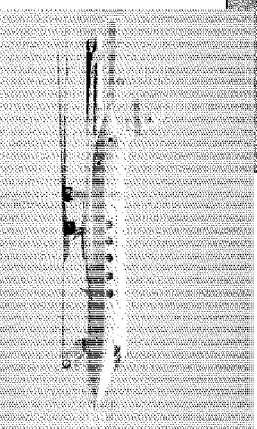
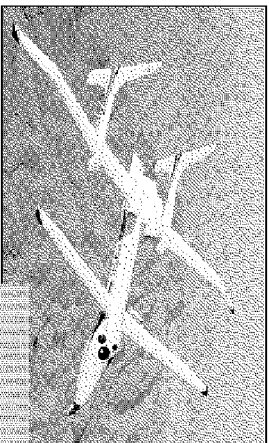

Intruder – Gulfstream III

- **Status:** Successfully completed over 50 collision scenarios during the last two weeks of September 2005.



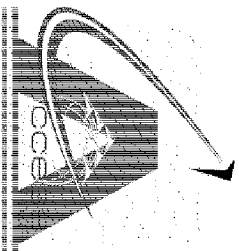

# Task 5: Perform CA Flight Test

## Test Scenarios

- Test scenarios included multiple collision geometries:
  - Co heading, Intruder overtaking
  - Low aspect, co-altitude
  - Co heading, Intruder climbing
  - Abeam, co-altitude
  - Head-on, co-altitude
  - Head-on, descending

Scenario #	HOST		INTRUDER		PICTORIAL
	Climb Rate (fpm)	Δψ (degrees)	Climb Rate (fpm)		
1	0	0	0		
2	0	10	0		
3	0	0	500		
4	0	-30	0		
5	0	130	0		
6	-500	180	0		

Scenario	Configuration					
	Buffer	4	2	0	4	TRT
1. Co-Heading, Co-Alt, Intruder Overtaking	6	4	2	0	4	0
2. Low Aspect, Co-Alt	0	0	0	0	2	2
3. Co-Heading, Intruder Climbing						
4. Abeam, Co-Alt	1	1	1	2	1	1
5. Head-On, Co-Alt	1	1	1	2	1	1
6. Head-On, Descending	1	1	1	2	1	1

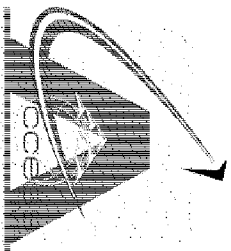

## ***Next Steps***

- Document the results and lessons learned from the Safety Analysis and Flight Test Activities
- Complete validating the CA Simulation tool
- Derive practical values/ranges for the TBDs in the performance requirements
  - Utilize the validated CA Simulation tool
  - Utilize the safety analysis results
- Begin Non-cooperative Collision Avoidance Activities
  - Derive unique Non-cooperative performance requirements
  - Perform Trade Studies and Concept Assessments
  - Conduct Non-cooperative Simulation Runs and Flight Demos
- Support RTCA SC-203 on developing the Sense & Avoid Minimum Aviation System Performance Standards (MASPS)

# QUESTIONS ?



**Russell Wolfe**

**Modern Technology Solutions, Inc.**

**Russell.C.Wolfe@mtsi-va.com**

**(703) 212-8870 x126**

# Exhibit 12

# Exhibit 12

## Lockheed's Polecat UCAV Demonstrator Crashes

Aviation Week & Space Technology

03/19/2007, page 44

Amy Butler

Washington

### **Polecat UAV has been labeled a total loss after December crash**

Printed headline: **Roadkill**

Lockheed Martin's Polecat unmanned aerial vehicle demonstrator has crashed months after accomplishing only three flight tests.

The incident takes the steam out of the company's strategy to fund its own project to keep pace with--and potentially surpass--work at Northrop Grumman and Boeing on government-funded *UAV* programs. Northrop Grumman and Boeing have been beneficiaries of the Pentagon's multibillion-dollar on-again off-again program to develop a combat UAV for the Navy and Air Force. And, both companies have flying demonstrators of varying maturity as a result of this support.

Lockheed Martin has no major government funding for its UAV efforts. But, company officials said that with Polecat they hoped to surpass the knowledge base of the nascent UAVs at rival companies and secure a foothold in the next-wave of Pentagon purchasing in this area--particularly for the Air Force's future bomber.

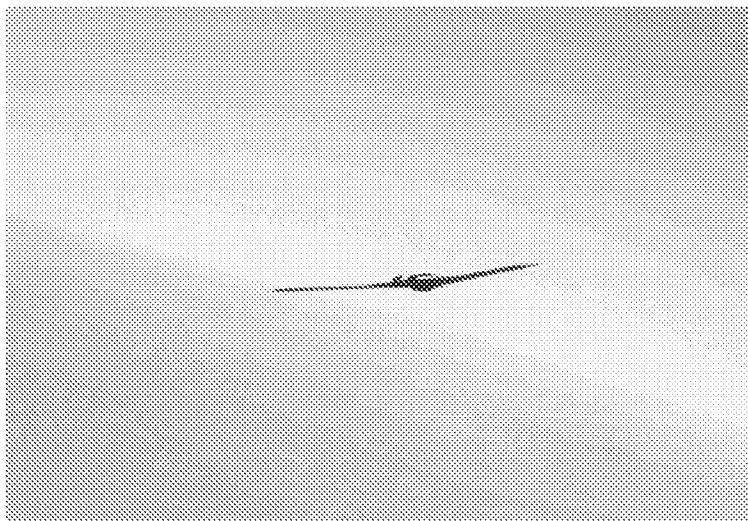

*Lockheed Martin officials took months to acknowledge the crash of its Polecat UAV development aircraft. Credit: LOCKHEED MARTIN*

THE POLECAT CRASH occurred Dec. 18, 2006, at the Air Force's Nevada Test and Training Range. Lockheed Martin officials say they could not discuss the crash any earlier due to a then-ongoing Air Force-led investigation that was only recently completed. The company notes that it had no formal customers for Polecat, but was restricted by government rules from discussing the incident since it occurred on a federal test range.

The 90-ft. wingspan demonstrator, which cost them more than \$30 million to develop, was declared a total loss as a result of the crash. The company is attributing the incident to an "irreversible unintentional failure in the flight termination ground equipment," though it was unable to say whether human error or a technical malfunction was a cause. The aircraft was, however, "in full control and performing well" when its automatic "fail-safe flight termination mode" activated, according to a Lockheed Martin statement. A company official says a failsafe, which prevented operators from recovering control of the UAV, initiated "in seconds," rendering them powerless as the aircraft dove to the ground.

"The fail-safe mode is designed to irreversibly terminate flight to ensure that systems do not deviate from the range into civilian airspace," according to a company statement. "There was an irreversible unintentional failure in the flight termination ground equipment at the Nevada Test and Training Range. We believe the test range has corrected the potential for a similar circumstance to occur again." Company officials say the Polecat validated rapid prototyping methods and that aerodynamic performance was "better than expected." They add, the flight termination software "performed exactly as expected."

The incident is an embarrassment for Lockheed Martin, which has been criticized for ignoring the UAV business and focusing too much on its booming manned fighter work on the F-22 and F-35. The company's efforts to conduct *UAV* testing fizzled after the termination of its DarkStar UAV program; one of its prototypes crashed in April 1996.

Yet, the company is not alone when it comes to embarrassing UAV incidents. Early in the development of the Global Hawk, a Northrop Grumman UAV, operators at one test range inadvertently engaged a self-destruct code that was picked up by a prototype UAV flying at a different range. The aircraft's extraordinarily high altitude gave it line-of-sight to both range sites. So, the *UAV* wound up in a self-destruct spiral and was declared a total loss.

For Lockheed Martin, Polecat's unveiling was the high point of the aeronautics sector's news briefings during last year's Farnborough air show in the U.K. (AW&ST July 24, 2006, p. 64). Frank Cappuccio, executive vice president for Lockheed Martin Skunk Works, showed a video clip during that briefing to reporters of the early Polecat flights. He touted the air vehicle as a demonstrator for new technologies in the areas of composites, fabrication and twisting strut designs to morph the UAV's wings in flight.

Polecat was the first public attempt by a company to demonstrate the effectiveness of a tailless Horton-wing design at altitudes in excess of 60,000 ft. The design, similar to the B-2's, is inherently stealthy because it lacks a tail. Skunk Works had wanted to experiment with it in high altitudes where the air is thin. Yet, with only three flights under its belt, the aircraft never climbed above 15,000 ft. to prove itself at high altitudes as planned.

Contrail suppression is also a problem the company hoped to tackle via its work on Polecat. Despite its high altitude, the U-2 has been plagued by contrails during its decades of operation. And, effective visible contrail suppression will augment the stealth qualities afforded through design and coatings. Polecat was not coated with stealthy materials, but the tailless design and angled engine inlets provided stealthy qualities to the demonstrator.

Frank Mauro, director of Lockheed Martin's unmanned systems at Skunk Works, said last year that work on Polecat would feed into the company's evolving designs for the Air Force long-range strike aircraft concept as well as needs beyond Northrop Grumman's Global Hawk for a future high-altitude UAV for intelligence collection. "Many lessons learned on this project will be applicable to future efforts, including Long Range Strike," according to the company statement.

The aircraft was designed to hoist 1,000 lb. of payload. It was powered by two FJ44-3E Williams International engines. Work began on Polecat in 2003 and it was ready for flight 18 months later.

# Exhibit 13

# Exhibit 13



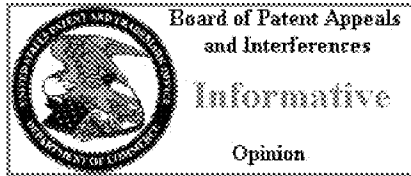

UNITED STATES PATENT AND TRADEMARK OFFICE

---

BEFORE THE BOARD OF PATENT APPEALS  
AND INTERFERENCES

---

*Ex parte* MAURICE GIVENS

---

Appeal 2009-003414  
Application 11/265,973  
Technology Center 2800

---

Decided: August 6, 2009

---

Before JOHN C. MARTIN, CARLA M. KRIVAK, and  
THOMAS S. HAHN, *Administrative Patent Judges*.

KRIVAK, *Administrative Patent Judge*.

DECISION ON APPEAL

Appellant appeals under 35 U.S.C. § 134(a) from a final rejection of claims 1-15. We have jurisdiction under 35 U.S.C. § 6(b).

We reverse.

STATEMENT OF CASE

Appellant's claimed invention is a method and apparatus for reducing noise associated with acoustic sensor outputs (Spec. ¶¶[0001]). Appellant's invention uses a sub-band spectral subtraction mechanism to process a noise cancellation mechanism output signal, producing a reduced noise acoustic data signal (Spec. ¶¶[0007]).

Independent claim 1, reproduced below, is representative of the subject matter on appeal.

1. A method for sensor output signal noise reduction comprising the steps of:

introducing at least one sensor output signal into an LMS-based adaptive noise canceller, producing a noise canceller output signal; and

introducing said noise canceller output signal into a sub-band spectral subtractive routine external to said LMS-based adaptive noise canceller, producing a reduced noise signal.

REFERENCE

Lin	US 2007/0090980 A1	Apr. 26, 2007 (filed Oct. 21, 2005)
-----	--------------------	--

The Examiner rejected claims 1-15 under 35 U.S.C. § 102(e) based upon the teachings of Lin.

The only contention is whether Lin teaches a sub-band spectral subtractive routine external to an LMS-based adaptive filter (App. Br. 7-9; Reply Br. 16-17; Ans. 11-12).

The Examiner finds that Lin teaches an LMS adaptive noise canceller 1412 that includes a sub-band spectral subtraction routine 1410 (Ans. 13). The Examiner further finds that Appellant has not provided a specific definition of “sub-band spectral subtractive routine” and thus, giving the term its broadest reasonable interpretation, the term can include any adaptive filter (Ans. 12). We cannot agree.

Appellant’s Specification explains that “sub-band spectral subtraction algorithms are . . . known to those skilled in the art” in paragraph [0023], sets forth the sub-band spectral subtractive mechanism in paragraph [0032], and also sets forth the function that implements the sub-band spectral noise-reduction algorithm (Appendix-Spec: 21-22). Although Appellant’s Specification does not specifically define the term “sub-band spectral subtractive routine,” this is a specific claim term for a specific type of filtering (Spec. ¶[0032]). Any interpretation that fails to give weight to “sub-band,” “spectral,” “subtractive,” and “routine” deprives the words in this claim term of their normal meaning. Thus, the “sub-band spectral subtractive routine” does not include just *any* adaptive filter, but rather refers to a specific filtering routine. Further, the output from Lin’s LMS based adaption circuit is fed to a summer 1124, 1224 (Lin Fig. 14), not a sub-band spectral subtractive routine. A summer is an additive circuit and not a subtractive circuit. Also, Lin does not describe the summer as operating on a sub-band. Thus, because Lin does not disclose each and every element of Appellant’s invention, Lin does not anticipate claims 1-15. *RCA Corp. v. Appl. Dig. Data Sys., Inc.*, 730 F.2d 1440, 1444 (Fed. Cir. 1984).

Appeal 2009-003414  
Application 11/265,973

CONCLUSION

The Examiner erred in rejecting claims 1-15 under 35 U.S.C.  
§ 102(e).

DECISION

The Examiner's decision rejecting claims 1-15 is reversed.

REVERSED

ke

MARK E. FEJER  
GAS TECHNOLOGY INSTITUTE  
1700 SOUTH MOUNT PROSPECT ROAD  
DES PLAINES IL 60018

# Exhibit 14

# Exhibit 14



Federal Aviation  
Administration

## Speech – "Safety Must Come First"

"Safety Must Come First"

J. Randolph Babbitt, Scottsdale, AZ

November 18, 2009

### AIA: Unmanned Aircraft Systems

#### *Remarks as prepared for delivery*

Good afternoon, and thank you, John [Langford, Chairman & President, Aurora Flight Sciences]. It's an exciting time in aviation and to be involved with introducing new technology into the National Airspace System. It's also a good time to be thinking and talking about personal and professional responsibility — something I have unfortunately had to do too much of lately. But we all — every professional in aviation — have a shared responsibility to make this system as absolutely as safe as it can be, and never to just a level where we would ever say, "We could do more, but this is safe enough".

So if we are direct with ourselves here, as of today, unmanned aircraft systems are not ready for seamless or routine use yet in civilian airspace. The idea of pilots flying remotely has been around for a long time. And it is, I truly believe, the way of the future. But where we are, on numerous fronts, they're not ready for open access to the NAS and we can't give you the thumbs up.

And you know that I'm not telling you anything that your technical folks aren't already telling you. While the UAS is undoubtedly the way of the future, my concern must be on today, and right now, the era of the unmanned aircraft system in civilian airspace is just not here yet. Much as we'd all wish the case were different, the level of technical maturity isn't where it needs to be for full operation in the NAS.

UAS is not plug-and-play. The technology has shown amazing potential and it's provided an astonishing value in use for what they're intended. As someone who's pulling for our troops overseas, I'm glad that unmanned aircraft systems are part of our military arsenal. When they gave the *Hunter* and the *Predator* their names, they weren't kidding.

But the issue here stateside is safety and it is Rule number one for everyone in the NAS. And being able to see-and-avoid is a fundamental part of that rule.

The definition of see and avoid for UAS is "the capability of an unmanned aircraft system to remain well clear from and avoid collisions with other airborne traffic and vice-versa." With the UAS, you're talking about a blend of technology that in terms of complexity is head and shoulders above anything we're doing now. That complexity is what makes it difficult to meld the UAS safely into a mature system like the NAS.

I think it's fair to compare the advent of the UAS with the introduction of the jet engine. We're talking about an exponential leap in capability, and that leap needs a contemporaneous jump in technology and procedures to do so safely.

We are considering the vast potential of UAS as we develop and implement NextGen, but it's an unacceptable risk to simply add today's level of UAS technology to today's NAS, and, I'd venture to say, that both you and the American public would agree.

We know the headlines following the helicopter accident over the Hudson on August 8th. That was followed by two Congressional hearings and calls to immediately shut down all traffic over the Hudson or sharply curtail these operations.

Now can you even imagine if one of those aircraft had been an unmanned system? With the headline: "Unmanned Robot plane crash kills 9." How do you think the Congress would react to that headline — after they confirmed my replacement?

That kind of scenario notwithstanding, I think unmanned aircraft systems are here to stay. In FY-09, there were about 20,000 flights in civilian airspace for a total of over 2,500 hours. And the number of operations that have been granted has more than tripled since 2007. But in order for us to get to the place where the UAS can become a viable, accepted part of the national airspace system, we have to make sure that sense-and-avoid is more than a given — it must be a guarantee.

Without a pilot who can look and scan to the left and the right — just the way you and I do when we're backing out of a parking space — there's a perceived level of risk that the American public isn't ready for.

As a safety regulator who is obligated to consider the total picture, I can tell you that proven performance must be the order of the day when it comes to UAS. We can't let our desire to focus on the enormous potential blind our safety concerns.

With that said, change is a joint effort. You drive change. The FAA ensures safety. And I do believe more community support is needed, and not just by DoD. Technology takes time. Development and maturity takes time — raising children should have proved that to you. But seriously, we know that from every aspect of our life experience that when you rush into something, your troubles have usually just begun. Consider, for example, that most of what you're doing now with unmanned aircraft takes places in the daylight. The challenge of night flying is not insignificant.

When you're dealing with the FAA, remember that all of the components need to be addressed. While air traffic will help you get from point A to point B, it's the aviation safety organization that sets the standards to be at point A. Our Airports group regulates point A and point B and other groups within the FAA setting standards for performance and maintenance of the machines and facilities. And I haven't yet mentioned the Human Factors considerations.

To assist and be ready for UAS reaching maturity, we have special program offices in our aviation safety and air traffic organization, military and other government organizational liaisons for UAS. We are doing what we can to help get you to market. My senior executives in Aviation Safety and Air Traffic, including Hank Krakowski, our COO, are meeting with the Government Executives that operate UAS in Dallas as we speak.

As far as UAS technology itself goes, most UAS have a single point of failure for hydraulics, electrical, flight control and satellite link. That's a concern.

When there's a single point of failure for something that runs into trouble every thousand hours, that's a problem. We have to address these risks. When you're talking about bringing something new into the airspace mix — something that could range from the size of a 737 to something as small as your fist, there's little doubt that there's a lot of homework that needs to get done first. That's part of earning the privilege to operate in the NAS. We're all going to going to have to act like we are from Missouri — "*Show me*".

For our part, we're working on an NPRM for small UAS. It will define standards for routine commercial operations to meet the needs of a large portion of the UAS community. And while limited, it represents a significant step forward in enabling this community. I think this experience will promote a better understanding of the challenges that you and I face. We're also working on revising a memorandum of agreement with DoD that addresses specific critical access needs.

The UAS Executive Committee — the ExCom — has been established to develop solutions to allow incremental access of UAS into the NAS. The ExCom is a multi-agency, Federal executive-level committee including FAA, DoD, DHS and NASA.

No organization can solve this challenge alone. But by combining the strengths, expertise and capabilities of the member organizations, we'll take on the task of UAS access much faster and will do it more efficiently. The ExCom has a tremendous amount of operational experience and have the lessons learned to implement policy and procedures. Additionally we're making sure we meet the requirements of the National Defense Authority Act.

We also have a special Committee with RTCA, SC-203, to develop standards. This is the primary method for you to support and promote the future of the UAS. These standards will serve as a basis for regulations.

And I also must mention that we're working with DoD and NASA on research as part of NextGen. This will not

only help us get to sense and avoid, but find interim solutions until we do.

Given that unmanned aircraft are becoming the method of choice to conduct mapping, fire detection, scientific missions, weather mapping, volcanic sampling, search and rescues, disaster response and security surveillance, the need for standardized regulations has never been more paramount.

And in closing, that is where we are. We need to develop standards for the future. But we must make sure that we're all moving in the same direction before it happens. Those safety standards must be the same for everyone, even if no one's in the cockpit.

###



# Exhibit 15

# Exhibit 15



This copy is for your personal, noncommercial use only. You can order presentation-ready copies for distribution to your colleagues, clients or customers [here](#) or use the "Reprints" tool that appears above any article. [Order a reprint of this article now.](#)

Printed on page A1

## PRESSED INTO SERVICE

# Pentagon Accident Reports Suggest Military's Drone Aircraft Plagued With Problems

By David Zucchino  
Los Angeles Times  
Published: Tuesday, July 6, 2010 at 10:48 p.m.

KANDAHAR, Afghanistan | The U.S. military often portrays its drone aircraft as high-tech marvels that can be operated seamlessly from thousands of miles away. But Pentagon accident reports reveal that the pilotless aircraft suffer from frequent system failures, computer glitches and human error.

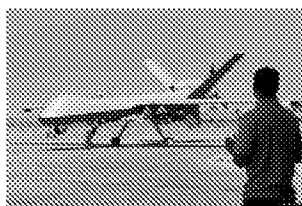

*Rick Loomis | Los Angeles Times*  
A pilot in a remote site at Kandahar Air Field uses a camera pod to remotely steer a Reaper aircraft back into base after a mission. Thirty-eight Predator and Reaper drones have crashed during combat missions in Afghanistan and Iraq, and nine more during training on bases in the U.S., with each crash costing between \$3.7 million and \$5 million.

Design and system problems were never fully addressed in the haste to push the fragile planes into combat over Afghanistan shortly after the Sept. 11, 2001, attacks more than eight years ago. Air Force investigators continue to cite pilot mistakes, coordination snafus, software failures, outdated technology and inadequate flight manuals.

Thirty-eight Predator and Reaper drones have crashed during combat missions in Afghanistan and Iraq, and nine more during training on bases in the U.S. - with each crash costing between \$3.7 million and \$5 million. Altogether, the Air Force says there have been 79 drone accidents costing at least \$1 million each.

Accident rates are dropping, but the raw numbers of

mishaps are increasing as use of the aircraft skyrockets, according to Air Force safety experts.

But no lives are lost, and for some experts, that's the most important point: For them, drones are the vanguard of a new type of remote warfare that minimizes the risk to U.S. personnel. The number of crashes, however, illustrates how quickly the unmanned aircraft have become an essential part of U.S. combat operations. At least 38 drones are in flight over Afghanistan and Iraq at any given time.

Flight hours over Afghanistan and Iraq more than tripled between 2006 and 2009. However, ground commanders in Afghanistan say only about a third of their requests for drone missions are met because of shortages of aircraft and pilots. The loss of aircraft to crashes and other accidents can hamper combat operations - and risk the lives of troops who depend on them for reconnaissance and air cover.

The Air Force acknowledges that armed drones were not ready when first deployed as the U.S. military geared up for the campaign to oust the Taliban and al-Qaida from Afghanistan. Most weapons systems are tested and refined for years. Unarmed drones had been in use since the mid-1990s, but the first armed version went to war just nine months after it was retrofitted.

It was pushed into use after a Predator successfully launched Hellfire antitank missiles at the Naval Air Weapons testing range at China Lake in January 2001.

"It was never designed to go to war when it did," said Lt. Col. Travis Burdine, a manager for the Air Force Unmanned Aircraft Systems Task Force. "We didn't have the luxury of ironing out some of the problems."

Technicians bought off-the-shelf equipment at Radio Shack and Best Buy to build a system to allow ground forces to see the drones' video feeds. At least one drone crashed because it had no fuel gauge, and the aircraft ran out of fuel. In another crash, investigators cited a design flaw: The "kill engine" switch was located next to the switch to lower the landing gear, and a ground-based pilot confused the two.

Even now, the planes are not designed for the amount of use they're getting, their defenders say. The 27-foot Predators and 36-foot Reapers operate under conditions that put enormous stress on the light drones - and the humans who operate them.

"These airplanes are flying 20,000 hours a month, OK?" said retired Rear Adm. Thomas J. Cassidy Jr., president of the aircraft systems group at General Atomics Aeronautical Systems in San Diego, which makes Predators and Reapers.

"That's a lot of flying," Cassidy said. "Some get shot down. Some run into bad weather. Some, people do stupid things with them. Sometimes they just run them out of gas."

The drones flew 185,000 hours over Afghanistan and Iraq in 2009, more than triple the number of hours flown in 2006. The Air Force expects that number to grow to 300,000 hours this year.

"The Air Force needs as many as they can get," said Col. Jeff Kappenman, director of the Center of Excellence for UAS Research, Education and Training at the University of North Dakota. "There has been exponential growth in need and demand."

Air Force officials say design and training improvements have lowered the Predator's accident rate. They say lessons learned from that plane's problems have solved some issues for the larger and more potent Reaper, in use in combat since 2007. Accident rates per 100,000 hours dropped to 7.5 for the Predator and 16.4 for the Reaper last year, according to the Air Force. The Predator rate is comparable to that of the F-16 fighter at the same stage, Air Force officers say, and just less than the 8.2 rate for small, single-engine private airplanes flown in the U.S.

The crash figures do not include drones flown over Pakistan by the CIA, which does not acknowledge the covert program. But independent experts said Predators flown over Pakistan probably experience problems similar to those flown by the Air Force in Afghanistan and Iraq.

Four Air Force Predators have crashed this year, three of them in Afghanistan - on Jan. 15 in southern Afghanistan, one on takeoff Feb. 9 in eastern Afghanistan, and a third March 14 in the southern part of the country. All were total losses, the Air Force said. Another Predator crashed in California during a training exercise April 20.

In the 12 months ended Sept. 30, the Air Force reported 16 Predator and Reaper accidents. Four involved crashes during a 15-day period in September. On Sept. 13, a pilot inside a ground station in Nevada lost video and data links to a Reaper over Afghanistan. As it was about to exit Afghan airspace and crash, an F-15 pilot was ordered to shoot it down and ground troops recovered the wreckage to keep top-secret technology out of insurgents' hands.

In another case, a drone crashed into a Sunni political headquarters in Mosul, Iraq. No injuries were reported.

In some cases, a cause is never determined and no wreckage is recovered. On May 13, 2009, a crew in Nevada lost contact with a Predator, and it was listed as "presumed crashed" somewhere in Afghanistan, according to an Air Force report. Retired Gen. Wesley K. Clark, asked whether high drone mishap rates concerned him, replied: "Not really. They're expendable." Others disagree.

"We can't treat these things like disposable diapers and just throw them out," retired Air Force Gen. Hal Hornburg, former chief of the Air Force Air Combat Command, warned officers at a conference on drones.

Kyle Snyder, who tracks military drones for the Association for Unmanned Vehicle Systems International, a nonprofit research group, said he had never heard anyone in the Air Force call drones expendable.

This story appeared in print on page A1

Copyright © 2011 TheLedger.com — All rights reserved. Restricted use only.

## **X. Related Proceedings Appendix**

There are no related proceedings so the Related Proceedings Appendix is blank (except for this statement.)