

1 Jed Margolin, Pro Se
2 1981 Empire Rd.
3 VC Highlands, NV 89521-7430
4 Telephone: 775-847-7845
5 Email: jm@jmargolin.com

10 UNITED STATES DISTRICT COURT
11 DISTRICT OF NEVADA
12

JED MARGOLIN,

Plaintiff,

vs.

CHARLES F. BOLDEN, Administrator,
National Aeronautics and Space
Administration,

Defendant.

)
)
)
) Case No. 3:09-cv-00421-LRH-(VPC)
)
)

) APPENDIX TO MEMORANDUM OF
) POINTS AND AUTHORITIES IN
) SUPPORT OF PLAINTIFF'S
) OPPOSITION TO MOTION TO
) DISMISS
)

13
14
15 Respectfully submitted,

16 /Jed Margolin/

17 Jed Margolin, plaintiff pro se
18 1981 Empire Rd.
19 VC Highlands, NV 89521-7430
20 775-847-7845
21 jm@jmargolin.com
22

23 Dated: September 24, 2009

1 **Documents**
2
3
4 Exhibit 1 - NASA Denial of Margolin FOIA Appeal A4
5
6 Exhibit 2 - USPTO database listing 662 patents assigned to The United States
7 of America as represented by the “Administrator of the National Aeronautics
8 and Space Administration.” A12
9
10 Exhibit 3 - Front page of U.S. Patent 7,590,904 A15
11
12 Exhibit 4 - Page from “**Suing the ‘Wrong’ Defendant in Judicial Review**
13 **of Federal Administrative Action: Proposals For Reform**” by Clark Byse
14 published in the Harvard Law Review in 1963 A17
15
16 Exhibit 5 - Harley G. Lappin, the Director of the Bureau of Prisons for
17 *Hardy v. Daniels*. From: http://www.bop.gov/about/co/director_bio.jsp A20
18
19 Exhibit 6 - First page of the decision in *John Doe Inc., et al. v. Mukasey, et al.*,
20 heard in the U.S. Court of Appeals for the Second Circuit, Docket No.
21 07-4943-cv, decided December 15, 2008 A22
22
23 Exhibit 7 - President Obama’s **Memorandum on the Freedom of Information**
24 **Act** January 21, 2009; From GPO Access, a service of the government printing
25 office at: www.gpoaccess.gov/presdocs/2009/DCPD200900009.pdf A24
26
27 Exhibit 8 - The Attorney General’s Memo on the Freedom of Information Act ... A27
28 From U.S. DOJ Web Site: www.usdoj.gov/ag/foia-memo-march2009.pdf
29
30
31

Exhibit 1

Exhibit 1



National Aeronautics and Space Administration

Headquarters

Washington, DC 20546-0001

August 5, 2009

Reply to Attn of:

Office of the General Counsel

Mr. Jed Margolin
1981 Empire Road
Reno, NV 89521-7430

Re: Appeal of FOIA 08-270

Dear Mr. Margolin:

This is a response to your letter dated June 10, 2009, appealing an initial determination under the Freedom of Information Act (FOIA), 5 U.S.C. § 552 et seq., issued on May 14, 2009, by Ms. Kellie N. Robinson, FOIA Public Liaison Officer, NASA Headquarters. Your original FOIA request of June 30, 2008, sought to obtain "all documents related to the Administrative Claim of Jed Margolin for Infringement of U.S. Patent Nos. 5,566,073 and 5,904,724; NASA Case No. I-222."

In the initial determination Ms. Robinson informed you that NASA Headquarters Office of General Counsel conducted a search and from that search certain enclosed documents were provided that were responsive to your request. In addition Ms. Robinson informed you that certain other documents found responsive to your request contain information that is exempt from disclosure under the deliberative process privilege of Exemption 5, 5 U.S.C. §552(b)(5).

In your appeal letter dated June 10, 2009, you assert that NASA did not give an estimate of the volume of the documents being withheld, in violation of 5 U.S.C. §552(a)(6)(F), which states that:

In denying a request for records, in whole or in part, an agency shall make a reasonable effort to estimate the volume of any requested matter the provision of which is denied, and shall provide any such estimate to the person making the request, unless providing such estimate would harm an interest protected by the exemption in subsection (b) pursuant to which the denial is made.

In addition to the alleged failure to provide this information your appeal letter requests documentation including:

- 1) Letter dated March 19, 2009, written by Mr. Gary G. Borda and addressed to Optima Technology Group (OTG);
- 2) Evidence (patent report) that Mr. Borda refers to in his letter and how such materials and/or documents are directed to the '724 claims; and
- 3) Records between NASA and Rapid Imaging Software (Mike Abernathy), which provided the synthetic vision system for the X-38 project which was referred to in the Borda letter.

Your appeal has been reviewed and processed pursuant to applicable statutes and regulations, specifically 14 CFR Part 1206. This process involved an examination of your original request, FOIA case law, the initial determination, the assertions made in your appeal, and related documentation.

First, in response to your assertion that you were not provided an estimate of the volume of documents withheld under Exemption 5, we now inform you that the withheld documents constitute approximately one hundred (100) pages in total volume.

Second, the document requested under item 1) above is already in your possession. You quoted the document verbatim in your appeal letter to NASA and included an exact copy in your materials (Appendix NA) that you returned to NASA accompanying your letter of appeal.

Third, I have determined that the documents you request under item 2) above are exempt from release under FOIA Exemption 5. The documents concerning the patent reports were prepared by attorneys in anticipation of litigation under NASA Case No. I-222. The preparation of the patent report was done in close collaboration between agency attorneys and agency personnel. Exemption 5 excludes from disclosure any documents that are "inter-agency or intra agency memorandums or letters which would not be available by law to a party other than an agency in litigation with the agency." 5 U.S.C. 552 (b)(5). This exemption protects from disclosure those documents and other memoranda prepared by an attorney in contemplation of litigation. See Hickman v. Taylor, 329 U.S. 495, 509-10 (1947); Fed. R. Civ. P. 26(b)(3). The exemption is not limited to civil proceedings, but extends to administrative proceedings. See Environmental Protection Services v. EPA, 364 F. Supp. 2d 575, 586 (N.D. W.Va. 2005). In addition the exemption protects "confidential communications between an attorney and his client relating to a legal matter for which the client has sought professional advice." See Mead Data Cent., Inc. v. U.S. Dep't of the Air Force, 566 F.2d 242, 252 (D.C. Cir. 1977); Electronic Privacy Information Center v. Dep't of Homeland Security, 384 F. Supp. 2d 100, (D.D.C. 2005). Your request that NASA show how such materials and/or documents are directed to the '724 claims is also protected by the attorney client privilege.

Finally, with regard to the documents you request under item 3), these documents exceed the scope of the original FOIA request you submitted on June 30, 2008. Your original request identified documents related to the Administrative Claim of Jed Margolin for Infringement of U.S. Patent Nos. 5,566,073 and 5,904,724; NASA Case No. I-222. That request was forwarded to the Office of General Counsel, NASA HQ, which maintains the administrative claim file that includes all the documents the Agency holds in connection with the patent infringement claim. However, your request did not identify documents relating to an independent program conducted through a contractual arrangement made over a decade ago at other NASA Centers. See Chester Kowalczyk v. Dep't of Justice, 73 F.3d 386 (D.C. Cir. 1996). You will need to make a separate request for these additional documents and provide more specificity as to the nature of the documents you are requesting.

In response to your appeal, I will affirm the initial determination.

This is a final determination and is subject to judicial review under the provisions of 5 U.S.C. § 552 (a)(4), a copy of which is enclosed.

Sincerely,

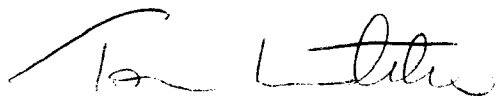

Thomas S. Luedtke
Associate Administrator
for Institutions and Management

Enclosure

cc:
HQ/Mr. Hargrove

Freedom of Information Act, Section 552(a)(4), as amended

(4)(A)(i) In order to carry out the provisions of this section, each agency shall promulgate regulations, pursuant to notice and receipt of public comment, specifying the schedule of fees applicable to the processing of requests under this section and establishing procedures and guidelines for determining when such fees should be waived or reduced. Such schedule shall conform to the guidelines which shall be promulgated, pursuant to notice and receipt of public comment, by the Director of the Office of Management and Budget and which shall provide for a uniform schedule of fees for all agencies.

(ii) Such agency regulations shall provide that—

(I) fees shall be limited to reasonable standard charges for document search, duplication, and review, when records are requested for commercial use;

(II) fees shall be limited to reasonable standard charges for document duplication when records are not sought for commercial use and the request is made by an educational or noncommercial scientific institution, whose purpose is scholarly or scientific research; or a representative of the news media; and

(III) for any request not described in (I) or (II), fees shall be limited to reasonable standard charges for document search and duplication.

In this clause, the term ‘a representative of the news media’ means any person or entity that gathers information of potential interest to a segment of the public, uses its editorial skills to turn the raw materials into a distinct work, and distributes that work to an audience. In this clause, the term ‘news’ means information that is about current events or that would be of current interest to the public. Examples of news-media entities are television or radio stations broadcasting to the public at large and publishers of periodicals (but only if such entities qualify as disseminators of ‘news’) who make their products available for purchase by or subscription by or free distribution to the general public. These examples are not all-inclusive. Moreover, as methods of news delivery evolve (for example, the adoption of the electronic dissemination of newspapers through telecommunications services), such alternative media shall be considered to be news-media entities. A freelance journalist shall be regarded as working for a news-media entity if the journalist can demonstrate a solid basis for expecting publication through that entity, whether or not the journalist is actually employed by the entity. A publication contract would present a solid basis for such an expectation; the Government may also consider the past publication record of the requester in making such a determination.

(iii) Documents shall be furnished without any charge or at a charge reduced below the fees established under clause (ii) if disclosure of the information is in the public interest because it is likely to contribute significantly to public understanding of the operations or activities of the government and is not primarily in the commercial interest of the requester.

(iv) Fee schedules shall provide for the recovery of only the direct costs of search, duplication, or review. Review costs shall include only the direct costs incurred during the initial examination of a document for the purposes of determining whether the documents must be disclosed under this section and for the purposes of withholding any portions exempt from disclosure under this section. Review costs may not include any costs incurred in resolving issues of law or policy that may be raised in the course of processing a request under this section. No fee may be charged by any agency under this section—

(I) if the costs of routine collection and processing of the fee are likely to equal or exceed the amount of the fee; or

(II) for any request described in clause (ii)(II) or (III) of this subparagraph for the first two hours of search time or for the first one hundred pages of duplication.

(v) No agency may require advance payment of any fee unless the requester has previously failed to pay fees in a timely fashion, or the agency has determined that the fee will exceed \$250.

(vi) Nothing in this subparagraph shall supersede fees chargeable under a statute specifically providing for setting the level of fees for particular types of records.

(vii) In any action by a requester regarding the waiver of fees under this section, the court shall determine the matter de novo: Provided, That the court's review of the matter shall be limited to the record before the agency.

(viii) An agency shall not assess search fees (or in the case of a requester described under clause (ii)(II), duplication fees) under this subparagraph if the agency fails to comply with any time limit under paragraph (6), if no unusual or exceptional circumstances (as those terms are defined for purposes of paragraphs (6)(B) and (C), respectively) apply to the processing of the request. [Effective one year from date of enactment of Public Law 110-175]

(B) On complaint, the district court of the United States in the district in which the complainant resides, or has his principal place of business, or in which the agency records are situated, or in the District of Columbia, has jurisdiction to enjoin the agency from withholding agency records and to order the production of any agency records improperly withheld from the complainant. In such a case the court shall determine the matter de novo, and may examine the contents of such agency records in camera to determine whether such records or any part thereof shall be withheld under any of the exemptions set forth in subsection (b) of this section, and the burden is on the agency to sustain its action. In addition to any other matters to which a court accords substantial weight, a court shall accord substantial weight to an affidavit of an agency concerning the agency's determination as to technical feasibility under paragraph (2)(C) and subsection (b) and reproducibility under paragraph (3)(B).

(C) Notwithstanding any other provision of law, the defendant shall serve an answer or otherwise plead to any complaint made under this subsection within thirty days after service upon the

defendant of the pleading in which such complaint is made, unless the court otherwise directs for good cause is shown.

[(D) Repealed. Pub. L. 98-620, title IV, Sec. 402(2), Nov. 8, 1984, 98 Stat. 3357.]

(E)(i) The court may assess against the United States reasonable attorney fees and other litigation costs reasonably incurred in any case under this section in which the complainant has substantially prevailed.

(ii) For purposes of this subparagraph, a complainant has substantially prevailed if the complainant has obtained relief through either—

(I) a judicial order, or an enforceable written agreement or consent decree; or

(II) a voluntary or unilateral change in position by the agency, if the complainant's claim is not insubstantial.

(F)(i) Whenever the court orders the production of any agency records improperly withheld from the complainant and assesses against the United States reasonable attorney fees and other litigation costs, and the court additionally issues a written finding that the circumstances surrounding the withholding raise questions whether agency personnel acted arbitrarily or capriciously with respect to the withholding, the Special Counsel shall promptly initiate a proceeding to determine whether disciplinary action is warranted against the officer or employee who was primarily responsible for the withholding. The Special Counsel, after investigation and consideration of the evidence submitted, shall submit his findings and recommendations to the administrative authority of the agency concerned and shall send copies of the findings and recommendations to the officer or employee or his representative. The administrative authority shall take the corrective action that the Special Counsel recommends.

(ii) The Attorney General shall—

(I) notify the Special Counsel of each civil action described under the first sentence of clause (i); and

(II) annually submit a report to Congress on the number of such civil actions in the preceding year.

(iii) The Special Counsel shall annually submit a report to Congress on the actions taken by the Special Counsel under clause (i).

(G) In the event of noncompliance with the order of the court, the district court may punish for contempt the responsible employee, and in the case of a uniformed service, the responsible member.

National Aeronautics and
Space Administration

Mail Code ME 00
Washington, DC 20546-0001

Official Business
Penalty for Private Use, \$300



Received 8-10-2009

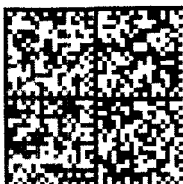

Hasler

016H16506946

\$00.610

08/06/2009

Mailed From 20546

US POSTAGE

A10

8952187430 P027

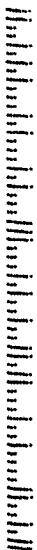

Exhibit 2

Exhibit 2

USPTO PATENT FULL-TEXT AND IMAGE DATABASE

- Home
- Quick
- Advanced
- Pat Num
- Help
- Next List
- Bottom
- View Cart

Searching US Patent Collection...

Results of Search in US Patent Collection db for:

AN/"Administrator of the National Aeronautics and Space Administration": 662 patents.

Hits 1 through 50 out of 662

Next 50 Hits

Jump To

Refine Search

PAT. NO.	Title
1	7,590,904 Systems and methods for detecting a failure event in a field programmable gate array
2	7,590,606 Multi-user investigation organizer
3	7,590,313 Phased-array optical whispering gallery mode modulation and method
4	7,588,703 Microencapsulation system and method
5	7,588,699 Electrically conductive, optically transparent polymer/carbon nanotube composites and process for preparation thereof
6	7,583,169 MEMS switches having non-metallic crossbeams
7	7,582,682 Removal of PCB and other halogenated organic contaminants found in ex situ structures
8	7,582,271 Emission control system
9	7,582,147 Composite powder particles
10	7,577,482 System comprising interchangeable electronic controllers and corresponding methods
11	7,574,338 Finite-difference simulation and visualization of elastodynamics in time-evolving generalized curvilinear coordinates
12	7,574,137 Multi-wavelength time-coincident optical communications system and methods thereof
13	7,568,608 Ultrasonic stir welding process and apparatus
14	7,561,946 Real time correction of aircraft flight configuration
15	7,558,371 Method of generating X-ray diffraction data for integral detection of twin defects in super-hetero-epitaxial materials
16	7,549,338 Nanostructure sensor of presence and concentration of a target molecule
17	7,548,199 Radiation-hardened fast acquisition/weak signal tracking system and method
18	7,544,146 Anti-backlash gear bearings
19	7,543,779 Low-impact mating system
20	7,543,274 System and method for deriving a process-based specification
21	7,542,885 Method and apparatus for predicting unsteady pressure and flow rate distribution in a fluid network
22	7,541,388 Polyimide foams
23	7,541,159 Molecular-specific urokinase antibodies
24	7,540,143 Boiler and pressure balls monopropellant thermal rocket engine
25	7,539,535 Real-time, high frequency QRS electrocardiograph with reduced amplitude zone detection

























- 26 [7,538,860](#)  [System and method for determination of the reflection wavelength of multiple low-reflectivity bragg gratings in a sensing optical fiber](#)
- 27 [7,537,182](#)  [Simultaneous multiple-location separation control](#)
- 28 [7,534,519](#)  [Symmetrical, bi-electrode supported solid oxide fuel cell](#)
- 29 [7,531,775](#)  [Photometer for tracking a moving light source](#)
- 30 [7,527,751](#)  [Method of making an electroactive sensing/actuating material for carbon nanotube polymer composite](#)
- 31 [7,520,176](#)  [Method for real-time structure shape-sensing](#)
- 32 [7,516,890](#)  [Interactive inventory monitoring](#)
- 33 [7,515,786](#)  [White-light whispering gallery mode optical resonator system and method](#)
- 34 [7,515,257](#)  [Short-range/long-range integrated target \(SLIT\) for video guidance sensor rendezvous and docking](#)
- 35 [7,513,460](#)  [Method and associated apparatus for capturing, servicing, and de-orbiting earth satellites using robotics](#)
- 36 [7,513,459](#)  [Method and associated apparatus for capturing, servicing, and de-orbiting earth satellites using robotics](#)
- 37 [7,512,568](#)  [Evolvable synthetic neural system](#)
- 38 [7,507,784](#)  [Liquid crystalline thermosets from ester, ester-imide, and ester-amide oligomers](#)
- 39 [7,501,636](#)  [Nanotunneling junction-based hyperspectral polarimetric photodetector and detection method](#)
- 40 [7,500,350](#)  [Elimination of lifetime limiting mechanism of hall thrusters](#)
- 41 [7,497,443](#)  [Resilient flexible pressure-activated seal](#)
- 42 [7,496,237](#)  [Image processing for binarization enhancement via fuzzy reasoning](#)
- 43 [7,491,428](#)  [Controlled deposition and alignment of carbon nanotubes](#)
- 44 [7,491,169](#)  [Ultrasonic apparatus and method to assess compartment syndrome](#)
- 45 [7,490,367](#)  [Solid and liquid waste drying bag](#)
- 46 [7,484,930](#)  [Noise reduction of aircraft flap](#)
- 47 [7,480,984](#)  [Method of suppressing sublimation in advanced thermoelectric devices](#)
- 48 [7,477,741](#)  [Analysis resistant cipher method and apparatus](#)
- 49 [7,469,878](#)  [Magnetostrictive valve assembly](#)
- 50 [7,467,921](#)  [Vortex control for rotor blade devices](#)
-



Exhibit 3

Exhibit 3

(12) **United States Patent**
Ng et al.

(10) **Patent No.:** **US 7,590,904 B2**
 (45) **Date of Patent:** **Sep. 15, 2009**

(54) **SYSTEMS AND METHODS FOR DETECTING A FAILURE EVENT IN A FIELD PROGRAMMABLE GATE ARRAY**

(75) Inventors: **Tak-Kwong Ng**, Yorktown, VA (US);
Jeffrey A. Herath, Yorktown, VA (US)

(73) Assignee: **The United States of America as represented by the Administrator of the National Aeronautics and Space Administration**, Washington, DC (US)

(*) Notice: Subject to any disclaimer, the term of this patent is extended or adjusted under 35 U.S.C. 154(b) by 388 days.

(21) Appl. No.: **11/531,703**

(22) Filed: **Sep. 14, 2006**

(65) **Prior Publication Data**

US 2007/0198892 A1 Aug. 23, 2007

Related U.S. Application Data

(60) Provisional application No. 60/774,810, filed on Feb. 1, 2006.

(51) **Int. Cl.**
G01R 31/28 (2006.01)
H03M 13/00 (2006.01)
G06F 11/00 (2006.01)
G06F 7/38 (2006.01)

(52) **U.S. Cl.** 714/725; 714/724; 714/732;
 714/754; 714/48; 326/37; 326/39

(58) **Field of Classification Search** 714/725,
 714/724, 732, 754; 326/37, 39
 See application file for complete search history.

(56) **References Cited**

U.S. PATENT DOCUMENTS

6,237,124 B1 *	5/2001	Plants	714/763
6,560,743 B2 *	5/2003	Plants	714/763
7,263,631 B2 *	8/2007	VanBuren	714/15
7,310,759 B1 *	12/2007	Carmichael et al.	714/725
2004/0078103 A1 *	4/2004	Marshall et al.	700/87
2006/0020774 A1 *	1/2006	Ramos et al.	712/226
2007/0176627 A1 *	8/2007	Ng et al.	326/14

* cited by examiner

Primary Examiner—John J Tabone, Jr.

(74) *Attorney, Agent, or Firm*—Helen M. Galus; Barry V. Gibbens

(57) **ABSTRACT**

An embodiment generally relates to a method of self-detecting an error in a field programmable gate array (FPGA). The method includes writing a signature value into a signature memory in the FPGA and determining a conclusion of a configuration refresh operation in the FPGA. The method also includes reading an outcome value from the signature memory.

20 Claims, 2 Drawing Sheets

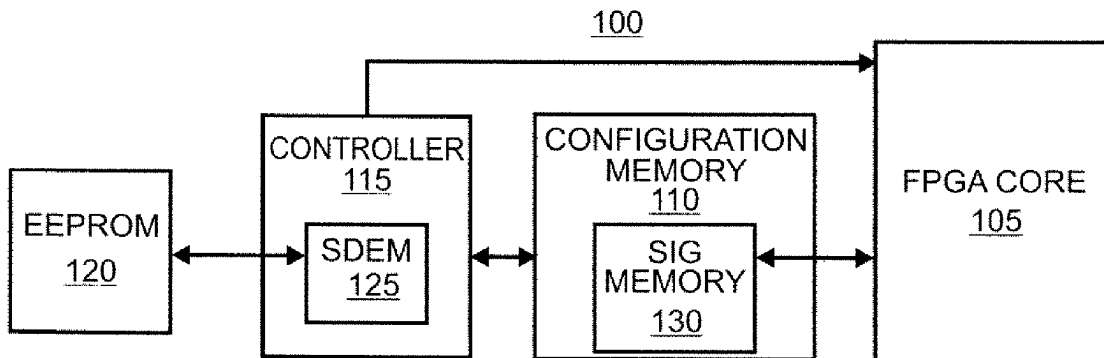

Exhibit 4

Exhibit 4

SUING THE "WRONG" DEFENDANT IN JUDICIAL REVIEW OF FEDERAL ADMINISTRATIVE ACTION: PROPOSALS FOR REFORM

Clark Byse *

In several recent cases plaintiffs have been denied judicial review of federal administrative action on the ground that the complaints named the "wrong" party as nominal defendant and the plaintiffs did not seek to amend their complaints before the time period for bringing the actions had expired. After carefully examining these cases, the author concludes that such results are undesirable and presents specific proposals for reform through legislation and amendment of the Federal Rules of Civil Procedure.

FOUR decisions recently reported in successive volumes of the *Federal Supplement* reached results so at odds with my sense of justice as to provoke this attempt to suggest a remedy.

The decisions denied judicial review to claimants for benefits under the Social Security Act. The reason for the denials was the plaintiffs' failure to bring their review actions against the incumbent Secretary of Health, Education, and Welfare. Instead, they mistakenly named the "wrong" defendant. In the four cases, the defendants named were, respectively: the United States;¹ Marion B. Folsom, Secretary of Health, Education, and Welfare (who had been succeeded in office by Arthur S. Flemming nineteen days before the complaint was filed);² the Department of Health, Education, and Welfare;³ and, finally, the Federal Security Administration.⁴ Although, for all that appears, the Govern-

* Professor of Law, Harvard Law School. B.E., Wisconsin State Teachers College, 1935; LL.B., Wisconsin, 1938; LL.M., Columbia, 1939, J.S.D., 1952.

¹ *Cunningham v. United States*, 199 F. Supp. 541 (W.D. Mo. 1959) [hereinafter cited as *Cunningham*]. (This case was incorrectly reported as having been decided in 1958.)

² *Sandridge v. Folsom, Secretary of Health, Educ. & Welfare*, 200 F. Supp. 25 (M.D. Tenn. 1959) [hereinafter cited as *Sandridge*]. The complaint stated that the defendant was "sued in his official and representative capacity." *Id.* at 26.

³ *Hall v. Department of Health, Educ. & Welfare*, 199 F. Supp. 833 (S.D. Tex. 1960) [hereinafter cited as *Hall*].

⁴ *Cohn v. Federal Security Administration*, 199 F. Supp. 884 (W.D.N.Y. 1961) [hereinafter cited as *Cohn*]. As the court noted, the Federal Security Administration was "a nonexistent agency." The Federal Security Agency and the office of Federal Security Administrator were abolished in 1953. All agencies of the Federal Security Agency and all functions of its administrator were, as of April 11,

Suing the "Wrong" Defendant in Judicial Review of Federal Administrative Action: Proposals for Reform, by Clark Byse © 1963 [The Harvard Law Review Association](#).

Abstract

In several recent cases plaintiffs have been denied judicial review of federal administrative action on the ground that the complaints named the "wrong" party as nominal defendant and the plaintiffs did not seek to amend their complaints before the time period for bringing the actions had expired. After carefully examining these cases, the author concludes that such results are undesirable and presents specific proposals for reform through legislation and amendment of the Federal Rules of Civil Procedure.

Exhibit 5

Exhibit 5

Central Office

Harley G. Lappin

Director,
Federal Bureau of Prisons

Harley G. Lappin was sworn in as Director of the Federal Bureau of Prisons on April 4, 2003. He is a career public administrator in the Federal Bureau of Prisons and the seventh Director of the Bureau since its establishment in 1930. He is responsible for the oversight and management of the Bureau's 114 institutions and for the safety and security of the more than 193,500 inmates under the agency's jurisdiction.

Director Lappin is a native of Akron, OH. He received a B.A. degree in Forensic Studies from Indiana University in Bloomington, IN in 1978 and a M.A. degree in Criminal Justice and Correctional Administration from Kent State University in Kent, OH in 1985.

Mr. Lappin began his career with the Bureau of Prisons in November 1985 as a Case Manager at the Federal Correctional Institution (FCI) in Texarkana, TX, a facility that housed 1,400 low security male offenders. He was subsequently promoted to Central Inmate Monitoring Administrator at the Western Regional Office in Belmont, CA. Then in 1989, Mr. Lappin was selected as Camp Administrator for the FCI in Jesup, GA, where he was responsible for managing a minimum security prison camp as a satellite operation to a medium security prison.

In 1991, Mr. Lappin was selected as Associate Warden for the Federal Medical Center in Carville, LA. His responsibilities included overseeing the institution's operations during a period when Carville was transitioning from the Public Health Service to the Bureau. At the time, the facility provided inpatient medical care to approximately 400 male offenders of all security levels.

He was selected Branch Administrator of the Program Review Division at the Bureau's Central Office in Washington, DC in 1993. In that capacity, Mr. Lappin was responsible for the Bureau's strategic planning and annual reviews of institution performance measures. Additionally, he was responsible for coordinating the review of functions that preceded the Bureau's reengineering efforts and developing performance measures for the executive staff modules.

Mr. Lappin was promoted to Warden at the FCI in Butner, NC in 1996. FCI Butner housed approximately 1,200 male offenders at the time representing several security levels. As Warden of that facility, he also managed a forensic center, inpatient and outpatient psychiatric units, sex offender treatment, and a satellite prison camp. He directed the development and implementation of the Habilitation Program to transition high security inmates to lower security facilities. In 1998, Mr. Lappin was selected as Warden at the United States Penitentiary (USP), Terre Haute, IN, where he was responsible for about 1,000 high security male inmates, a satellite prison camp, and national bus operations. At USP Terre Haute, Mr. Lappin activated the Bureau's Special Confinement Unit, which houses Federal inmates under death sentences, and implemented the Federal execution protocol. Mr. Lappin carried out the daunting responsibility of presiding over the first two executions by the Federal system since 1963.

Mr. Lappin was promoted to Regional Director of the Mid-Atlantic Region in July 2001. As Regional Director, he was responsible for oversight of 16 institutions (including 2 correctional complexes) and 3 community corrections offices located in a seven-state area.

Mr. Lappin chaired the Bureau's Management Reengineering Team (MRT). Under Mr. Lappin's leadership, the MRT successfully reduced the number of management positions and supervisory layers while maintaining the quality of operations throughout the agency. The MRT also initiated pilot-testing of innovative organizational configurations at multiple Bureau institutions to assess impact on line staff and management work processes of these non-traditional organizational alignments.

Additionally, he chaired the Bureau's "Forward Thinking" workgroup, initially composed of five senior managers. The workgroup represents the agency's focused attempt to ensure it is well-positioned and prepared to meet future challenges.

In 1992, Mr. Lappin received the Associate Warden of the Year award for the Bureau's South Central Region. He received the Bureau's Excellence in Prison Management Award in 2000 for his oversight of the activation of the Special Confinement Unit at USP Terre Haute, combined with strategies he implemented to reduce per capita costs. In 2001, he received the Attorney General's Award for Excellence in Management for the manner in which he carried out the responsibilities associated with the 2001 Federal executions, a manner exemplifying the best qualities of Bureau leadership. Most recently (2004), he received the Presidential Rank Award of Meritorious Executive.

Mr. Lappin is a member of the American Correctional Association's Standards Committee, which

Central Office Divisions

- [Administration](#)
- [Correctional Programs](#)
- [Health Services](#)
- [Human Resource Management](#)
- [Industries, Education, and V.T.](#)
- [Information, Policy, & Public Affairs](#)
- [National Institute of Corrections](#)
- [Office of General Counsel](#)
- [Program Review](#)

Exhibit 6

Exhibit 6

07-4943-cv
John Doe Inc., et al. v. Mukasey, et al.

UNITED STATES COURT OF APPEALS
FOR THE SECOND CIRCUIT

August Term 2008

Heard: August 27, 2008

Decided: December 15, 2008

Docket No. 07-4943-cv

JOHN DOE, INC., JOHN DOE, AMERICAN CIVIL LIBERTIES
UNION, AMERICAN CIVIL LIBERTIES UNION FOUNDATION,
Plaintiffs-Appellees,

v.

MICHAEL B. MUKASEY, in his official capacity as
U.S. Attorney General of the United States,
ROBERT MUELLER, in his official capacity as
Director of the Federal Bureau of Investigation,
VALERIE E. CAPRONI, in her official capacity as
General Counsel of the Federal Bureau of
Investigation,
Defendants-Appellants.

Before: NEWMAN, CALABRESI, and SOTOMAYOR, Circuit Judges.

Appeal by the Government from the September 7, 2007, judgment of
the United States District Court for the Southern District of New York
(Victor Marrero, District Judge), in litigation concerning First
Amendment challenges to the constitutionality of statutes governing
the issuance and judicial review of National Security Letters
("NSLs"), 18 U.S.C. §§ 2709, 3511(b), which request records from
providers of wire or electronic communication services. The judgment,
stayed on appeal, enjoins FBI officials from (1) issuing NSLs under

Exhibit 7

Exhibit 7

Administration of Barack H. Obama, 2009

Memorandum on the Freedom of Information Act

January 21, 2009

Memorandum for the Heads of Executive Departments and Agencies

Subject: Freedom of Information Act

A democracy requires accountability, and accountability requires transparency. As Justice Louis Brandeis wrote, "sunlight is said to be the best of disinfectants." In our democracy, the Freedom of Information Act (FOIA), which encourages accountability through transparency, is the most prominent expression of a profound national commitment to ensuring an open Government. At the heart of that commitment is the idea that accountability is in the interest of the Government and the citizenry alike.

The Freedom of Information Act should be administered with a clear presumption: In the face of doubt, openness prevails. The Government should not keep information confidential merely because public officials might be embarrassed by disclosure, because errors and failures might be revealed, or because of speculative or abstract fears. Nondisclosure should never be based on an effort to protect the personal interests of Government officials at the expense of those they are supposed to serve. In responding to requests under the FOIA, executive branch agencies (agencies) should act promptly and in a spirit of cooperation, recognizing that such agencies are servants of the public.

All agencies should adopt a presumption in favor of disclosure, in order to renew their commitment to the principles embodied in FOIA, and to usher in a new era of open Government. The presumption of disclosure should be applied to all decisions involving FOIA.

The presumption of disclosure also means that agencies should take affirmative steps to make information public. They should not wait for specific requests from the public. All agencies should use modern technology to inform citizens about what is known and done by their Government. Disclosure should be timely.

I direct the Attorney General to issue new guidelines governing the FOIA to the heads of executive departments and agencies, reaffirming the commitment to accountability and transparency, and to publish such guidelines in the *Federal Register*. In doing so, the Attorney General should review FOIA reports produced by the agencies under Executive Order 13392 of December 14, 2005. I also direct the Director of the Office of Management and Budget to update guidance to the agencies to increase and improve information dissemination to the public, including through the use of new technologies, and to publish such guidance in the *Federal Register*.

This memorandum does not create any right or benefit, substantive or procedural, enforceable at law or in equity by any party against the United States, its departments, agencies, or entities, its officers, employees, or agents, or any other person.

The Director of the Office of Management and Budget is hereby authorized and directed to publish this memorandum in the *Federal Register*.

BARACK OBAMA

[Filed with the Office of the Federal Register, 11:15 a.m., January 23, 2009]

NOTE: This memorandum was released by the Office of the Press Secretary on January 22, and it was published in the *Federal Register* on January 26.

Categories: Communications to Federal Agencies : Freedom of Information Act, memorandum.

Subjects: Freedom of Information Act.

DCPD Number: DCPD200900009.

Exhibit 8

Exhibit 8



Office of the Attorney General

Washington, D.C. 20530

March 19, 2009

MEMORANDUM FOR HEADS OF EXECUTIVE DEPARTMENTS AND AGENCIES

FROM:  THE ATTORNEY GENERAL

SUBJECT: The Freedom of Information Act (FOIA)

The Freedom of Information Act (FOIA), 5 U.S.C. § 552, reflects our nation's fundamental commitment to open government. This memorandum is meant to underscore that commitment and to ensure that it is realized in practice.

A Presumption of Openness

As President Obama instructed in his January 21 FOIA Memorandum, "The Freedom of Information Act should be administered with a clear presumption: In the face of doubt, openness prevails." This presumption has two important implications.

First, an agency should not withhold information simply because it may do so legally. I strongly encourage agencies to make discretionary disclosures of information. An agency should not withhold records merely because it can demonstrate, as a technical matter, that the records fall within the scope of a FOIA exemption.

Second, whenever an agency determines that it cannot make full disclosure of a requested record, it must consider whether it can make partial disclosure. Agencies should always be mindful that the FOIA requires them to take reasonable steps to segregate and release nonexempt information. Even if some parts of a record must be withheld, other parts either may not be covered by a statutory exemption, or may be covered only in a technical sense unrelated to the actual impact of disclosure.

At the same time, the disclosure obligation under the FOIA is not absolute. The Act provides exemptions to protect, for example, national security, personal privacy, privileged records, and law enforcement interests. But as the President stated in his memorandum, "The Government should not keep information confidential merely because public officials might be embarrassed by disclosure, because errors and failures might be revealed, or because of speculative or abstract fears."

Pursuant to the President's directive that I issue new FOIA guidelines, I hereby rescind the Attorney General's FOIA Memorandum of October 12, 2001, which stated that the Department of Justice would defend decisions to withhold records "unless they lack a sound

Memorandum for Heads of Executive Departments and Agencies
Subject: The Freedom of Information Act

Page 2

legal basis or present an unwarranted risk of adverse impact on the ability of other agencies to protect other important records.”

Instead, the Department of Justice will defend a denial of a FOIA request only if (1) the agency reasonably foresees that disclosure would harm an interest protected by one of the statutory exemptions, or (2) disclosure is prohibited by law. With regard to litigation pending on the date of the issuance of this memorandum, this guidance should be taken into account and applied if practicable when, in the judgment of the Department of Justice lawyers handling the matter and the relevant agency defendants, there is a substantial likelihood that application of the guidance would result in a material disclosure of additional information.

FOIA Is Everyone's Responsibility

Application of the proper disclosure standard is only one part of ensuring transparency. Open government requires not just a presumption of disclosure but also an effective system for responding to FOIA requests. Each agency must be fully accountable for its administration of the FOIA.

I would like to emphasize that responsibility for effective FOIA administration belongs to all of us—it is not merely a task assigned to an agency's FOIA staff. We all must do our part to ensure open government. In recent reports to the Attorney General, agencies have noted that competing agency priorities and insufficient technological support have hindered their ability to implement fully the FOIA Improvement Plans that they prepared pursuant to Executive Order 13392 of December 14, 2005. To improve FOIA performance, agencies must address the key roles played by a broad spectrum of agency personnel who work with agency FOIA professionals in responding to requests.

Improving FOIA performance requires the active participation of agency Chief FOIA Officers. Each agency is required by law to designate a senior official at the Assistant Secretary level or its equivalent who has direct responsibility for ensuring that the agency efficiently and appropriately complies with the FOIA. That official must recommend adjustments to agency practices, personnel, and funding as may be necessary.

Equally important, of course, are the FOIA professionals in the agency who directly interact with FOIA requesters and are responsible for the day-to-day implementation of the Act. I ask that you transmit this memorandum to all such personnel. Those professionals deserve the full support of the agency's Chief FOIA Officer to ensure that they have the tools they need to respond promptly and efficiently to FOIA requests. FOIA professionals should be mindful of their obligation to work “in a spirit of cooperation” with FOIA requesters, as President Obama has directed. Unnecessary bureaucratic hurdles have no place in the “new era of open Government” that the President has proclaimed.

Memorandum for Heads of Executive Departments and Agencies
Subject: The Freedom of Information Act

Page 3

Working Proactively and Promptly

Open government requires agencies to work proactively and respond to requests promptly. The President's memorandum instructs agencies to "use modern technology to inform citizens what is known and done by their Government." Accordingly, agencies should readily and systematically post information online in advance of any public request. Providing more information online reduces the need for individualized requests and may help reduce existing backlogs. When information not previously disclosed is requested, agencies should make it a priority to respond in a timely manner. Timely disclosure of information is an essential component of transparency. Long delays should not be viewed as an inevitable and insurmountable consequence of high demand.

In that regard, I would like to remind you of a new requirement that went into effect on December 31, 2008, pursuant to Section 7 of the OPEN Government Act of 2007, Pub. L. No. 110-175. For all requests filed on or after that date, agencies must assign an individualized tracking number to requests that will take longer than ten days to process, and provide that tracking number to the requester. In addition, agencies must establish a telephone line or Internet service that requesters can use to inquire about the status of their requests using the request's assigned tracking number, including the date on which the agency received the request and an estimated date on which the agency will complete action on the request. Further information on these requirements is available on the Department of Justice's website at www.usdoj.gov/oip/foiapost/2008foiapost30.htm.

Agency Chief FOIA Officers should review all aspects of their agencies' FOIA administration, with particular focus on the concerns highlighted in this memorandum, and report to the Department of Justice each year on the steps that have been taken to improve FOIA operations and facilitate information disclosure at their agencies. The Department of Justice's Office of Information Policy (OIP) will offer specific guidance on the content and timing of such reports.

I encourage agencies to take advantage of Department of Justice FOIA resources. OIP will provide training and additional guidance on implementing these guidelines. In addition, agencies should feel free to consult with OIP when making difficult FOIA decisions. With regard to specific FOIA litigation, agencies should consult with the relevant Civil Division, Tax Division, or U.S. Attorney's Office lawyer assigned to the case.

This memorandum is not intended to, and does not, create any right or benefit, substantive or procedural, enforceable at law or equity by any party against the United States, its departments, agencies, instrumentalities or entities, its officers, employees, agents, or any other person.