

08/	Class	Subclass	ISSUE CLASSIFICATION

UTILITY SERIAL NUMBER	08/ 274394	PATENT DATE	PATENT NUMBER
SERIAL NUMBER	08/274,394	FILING DATE	07/11/94
CLASS	375	SUBCLASS	369
GROUP PART UNIT	2614	EXAMINER	None

APPLICANTS JED MARGOLIN, SAN JOSE, CA.

CONTINUING DATA***
VERIFIED

TN

FOREIGN/PCT APPLICATIONS***
VERIFIED

TN

***** SMALL ENTITY *****

Foreign priority claimed 35 USC 119 conditions met	<input type="checkbox"/> yes <input checked="" type="checkbox"/> no <input type="checkbox"/> yes <input checked="" type="checkbox"/> no	AS FILED	STATE OR COUNTRY	SHEETS OR DRWGS.	TOTAL CLAIMS	INDER CLAIMS	FILING FEE RECEIVED	ATTORNEY'S DOCKET NO.
Verified and Acknowledged	Examiner's Initials	→	CA	13	13	3	\$355.00	

ADDRESS JED MARGOLIN
3570 PLEASANT ECHO DRIVE
SAN JOSE CA 95148-1916
Keith J. Askoff
Blakely, Sokoloff, Taylor & Zisman
12400 Wilshire Boulevard, 21st floor
Los Angeles CA 90025

TITLE PILOT AID USING SYNTHETIC REALITY ENVIRONMENT

U.S. DEPT. of COMM. Pat. & TM Office - PTO-436L (Rev. 10-

PARTS OF APPLICATION FILED SEPARATELY		Applications Examiner	
NOTICE OF ALLOWANCE MAILED		CLAIMS ALLOWED	
Assistant Examiner		Total Claims	Print Claim
ISSUE FEE		DRAWING	
Amount Due	Date Paid	Sheets Drwg.	Figs. Drwg.
Label Area		Print Fig.	
Primary Examiner		ISSUE BATCH NUMBER	
PREPARED FOR ISSUE			
WARNING: The information disclosed herein may be restricted. Unauthorized disclosure may be prohibited by the United States Code Title 35, Sections 122, 181 and 368. Possession outside the U.S. Patent & Trademark Office is restricted to authorized employees and contractors only.			

08/ 274394



APPROVED FOR LICENSE

INITIALS _____

Date Entered or Counted

CONTENTS

RECEIVED

Date Received PAT & T.M. OFFICE MAILED

SEP 27 1994

SEP 14 1994

GROUP 200 LICENSING & REVIEW

Date Entered or Counted	Description	Date
	1. Application papers.	
10-12-94	2. P2152 ART	7-11-94
11-7-94	3. Rej. (3)	11-9-94
	4. Lett. New Disp.	2-13-95
3-6	5. Annot. A	2-13-95
5-9	6. Final Rej 3 Mos	5-9-95
	7. Ex. Inlet Sum	7-8-95
	8. Annot. B nr. ①	7-14-95
	9. Chg. of Address	7-14-95
8-3	10. Address Change	8-3-95
10-16 A	11. Address Acknowledgment	10/19/95
	12.	
	13.	
	14.	
	15.	
	16.	
	17.	
	18.	
	19.	
	20.	
	21.	
	22.	
	23.	
	24.	
	25.	
	26.	
	27.	
	28.	
	29.	
	30.	
	31.	
	32.	

01401

SEARCHED			
Class	Sub.	Date	Exmr.
364	449 444 448 459 460 462	11/03/94	TN
340	961 967 974 980 990 995	11/04/94	TN
342	29 450 451 463		
345	101		
update search to above		05/09/95	TN

35

INTERFERENCE SEARCHED			
Class	Sub.	Date	Exmr.

SEARCH NOTES		
	Date	Exmr.
APS search	11/08/94	TN
<pre> FILE 'USPAT' ENTERED AT 11:41:41 ON 06 NOV 94) DEL HIS ACT POLYGON/L ----- L1 (1)SEA FILE-USPAT PLU-ON 5005148/PM AND POLYGM L2 (1)SEA FILE-USPAT PLU-ON POLYGON (10A) DATA BASE L3 (1)SEA FILE-USPAT PLU-ON TERRAIN (P) RAHWALL (CA) STRM L4 (1)SEA FILE-USPAT PLU-ON 12 AND L3 L5 (1)SEA FILE-USPAT PLU-ON 12 AND AIRCRAFT L6 (1)SEA FILE-USPAT PLU-ON 15 AND (TERRAIN OR RAHWALL) (MOC L7 (1)SEA FILE-USPAT PLU-ON 15 AND (TERRAIN OR RAHWALL) (MCT L8 (1)SEA FILE-USPAT PLU-ON POLYGON (P) (TERRAIN OR RAHW) S L9 (1)SEA FILE-USPAT PLU-ON 18 AND AIRCRAFT AND DATA BASE L10 (1)SEA FILE-USPAT PLU-ON 18 AND ALTITUDE AND ORIENT ----- FILE 'USPAT' ENTERED AT 11:43:41 ON 06 NOV 94) ACT DISPLAY/L ----- L1 (1)SEA FILE-USPAT PLU-ON (AIRCRAFT OR CRAFT) AND DISP AND L2 (1)SEA FILE-USPAT PLU-ON AVONIC OR GYROCOMPASS OR TO BA L3 (1)SEA FILE-USPAT PLU-ON DIGITAL (BA) DATA BASE AND P TERRAIN AND RAHWALL (CA) STR L4 (1)SEA FILE-USPAT PLU-ON GPS OR GLOBAL POSITIONING SY L5 (1)SEA FILE-USPAT PLU-ON VISUAL FLIGHT RULE OR CFR L6 (1)SEA FILE-USPAT PLU-ON INSTRUMENT FLIGHT RULE OR I L7 (1)SEA FILE-USPAT PLU-ON THREE (BA) DIMENSION (P) TFF L8 (1)SEA FILE-USPAT PLU-ON (PAN// OR TILT// OR ZOOM O FF) L9 (1)SEA FILE-USPAT PLU-ON L1 AND L2 AND L8 L10 (1)SEA FILE-USPAT PLU-ON L6 AND L7 L11 (1)SEA FILE-USPAT PLU-ON L11 AND L5 L12 (1)SEA FILE-USPAT PLU-ON L11 AND L5 </pre>		
APS search	05/14/95	TN
<pre> FILE 'USPAT' ENTERED AT 05:29:55 ON 04 MAY 95) L1 (1)SEA TERRAIN (P) POLYGON L2 (1)SEA L1 AND AIRCRAFT L3 (1)SEA L2 AND (THREE ON 1) (L3A) (DIMENSION// OR L3) L4 (1)SEA ELEVAT// (20A) DATA (L) TERRAIN L5 (1)SEA L3 AND L1A L6 (1)SEA L1 AND ELEVATION </pre>		

01402

PATENT APPLICATION FEE DETERMINATION RECORD

Effective October 1, 1992

Application or Docket Number

118/274394

CLAIMS AS FILED - PART I

(Column 1)		(Column 2)	SMALL ENTITY		OR	OTHER THAN SMALL ENTITY	
FOR	NUMBER FILED	NUMBER EXTRA	RATE	FEE		RATE	FEE
BASIC FEE				\$355.00	OR		\$710.00
TOTAL CLAIMS	13	minus 20 = *	x\$11=		OR	x\$22=	
INDEPENDENT CLAIMS	3	minus 3 = *	x 37=		OR	x 74=	
MULTIPLE DEPENDENT CLAIM PRESENT			+115=		OR	+230=	
			TOTAL	355	OR	TOTAL	

* If the difference in column 1 is less than zero, enter "0" in column 2

CLAIMS AS AMENDED - PART II

AMENDMENT A	(Column 1)	(Column 2)	(Column 3)	SMALL ENTITY		OR	OTHER THAN SMALL ENTITY	
	CLAIMS REMAINING AFTER AMENDMENT	HIGHEST NUMBER PREVIOUSLY PAID FOR	PRESENT EXTRA	RATE	ADDITIONAL FEE		RATE	ADDITIONAL FEE
Total	39	Minus ** 20	= 19	x\$11=	209	OR	x\$22=	
Independent	5	Minus *** 3	= 1	x 37=	76	OR	x 74=	
FIRST PRESENTATION OF MULTIPLE DEPENDENT CLAIM			+ 115=		OR	+230=		
			TOTAL		OR	TOTAL		

AMENDMENT B	(Column 1)	(Column 2)	(Column 3)	SMALL ENTITY		OR	OTHER THAN SMALL ENTITY	
	CLAIMS REMAINING AFTER AMENDMENT	HIGHEST NUMBER PREVIOUSLY PAID FOR	PRESENT EXTRA	RATE	ADDITIONAL FEE		RATE	ADDITIONAL FEE
Total	37	Minus ** 37	=	x\$11=		OR	x\$22=	
Independent	4	Minus *** 5	=	x 37=		OR	x 74=	
FIRST PRESENTATION OF MULTIPLE DEPENDENT CLAIM			+ 115=		OR	+230=		
			TOTAL		OR	TOTAL		

AMENDMENT C	(Column 1)	(Column 2)	(Column 3)	SMALL ENTITY		OR	OTHER THAN SMALL ENTITY	
	CLAIMS REMAINING AFTER AMENDMENT	HIGHEST NUMBER PREVIOUSLY PAID FOR	PRESENT EXTRA	RATE	ADDITIONAL FEE		RATE	ADDITIONAL FEE
Total	*	Minus **	=	x\$11=		OR	x\$22=	
Independent	*	Minus ***	=	x 37=		OR	x 74=	
FIRST PRESENTATION OF MULTIPLE DEPENDENT CLAIM			+ 115=		OR	+230=		
			TOTAL		OR	TOTAL		

* If the entry in column 1 is less than the entry in column 2, write "0" in column 3.

** If the "Highest Number Previously Paid For" IN THIS SPACE is less than 20, enter "20".

*** If the "Highest Number Previously Paid For" IN THIS SPACE is less than 3, enter "3".

The "Highest Number Previously Paid For" (Total or Independent) is the highest number found in the appropriate box in column 1.

PAGE DATA ENTRY CODING SHEET

U.S. DEPARTMENT OF COMMERCE
Patent and Trademark Office

1ST EXAMINER
2ND EXAMINER

49 DATE 8-10-94

274394

APPLICATION NUMBER

TYPE APPL

FILING DATE MONTH DAY YEAR

SPECIAL HANDLING

GROUP ART UNIT

CLASS

SHEETS OF DRAWING

TOTAL CLAIMS

INDEPENDENT CLAIMS

SMALL ENTITY?

FILING FEE

FOREIGN LICENSE

ATTORNEY DOCKET NUMBER

CONTINUITY DATA

CONT STATUS CODE

PARENT APPLICATION SERIAL NUMBER

PCT APPLICATION SERIAL NUMBER

PARENT PATENT NUMBER

PARENT FILING DATE MONTH DAY YEAR

P	C	T	/																
P	C	T	/																
P	C	T	/																
P	C	T	/																
P	C	T	/																

PCT/FOREIGN APPLICATION DATA

FOREIGN PRIORITY CLAIMED

COUNTRY CODE

PCT/FOREIGN APPLICATION SERIAL NUMBER

FOREIGN FILING DATE

provide a high-level, device-independent communication layer between the user subsystems and the ITARS hardware. These routines properly construct ITARS messages from the values specified in their input arguments and send the messages to the Brass Board process. In addition, these routines asynchronously receive data from the Brass Board process, and double-buffer it for later use by the user subsystem.

To accelerate the integration effort, Merit Technology created a program known as the ITARS Emulator. This program coexisted on the microVAX with the other user subsystems and provided terrain elevation data (at a reduced resolution) in a message format defined in the ITARS ICD. The Emulator also received aircraft state vectors, point feature messages and user request messages sent by the aircraft model and main RDS task. Like the Brass Board process, each user subsystem communicated with the ITARS Emulator through the IDIR software. The Emulator proved to be an invaluable tool for system debugging and led to a significant change in the integration plan.

The original integration plan defined the IDIR as the final layer between the user subsystems and the RDS/ITARS communication hardware. The plan called for rewriting the IDIR software to communicate directly with the ITARS. This was determined to be a significant effort because the original IDIR software used DECNET for all of its interhost communication. The RDS/ITARS IDIR software would also need functionality similar to DECNET. The idea arose to add Ethernet and 1553 interfaces to the ITARS Emulator and forward messages "through" the Emulator to the ITARS hardware, hence the Brass Board process was born. An early version of the Brass Board process was an ITARS Emulator with a 1553 interface forwarding messages to the ITARS. This configuration provided a needed incremental integration step and allowed the RDS to operate without an Ethernet link from the ITARS (terrain data was generated by the Emulator). Later versions eliminated the ITARS Emulation logic and included an Ethernet interface. The advantage of this layered approach preserved the DECNET IDIR interface, eliminating any code changes to the user subsystems. Indeed, the user subsystems are "unaware" of the source of their elevation data.

Results of system integration

During integration several key lessons were learned about the RDS. As the system neared completion, it became apparent that limitations existed in the area of software partitioning. Although it is possible to host each subsystem in any

machine, the configuration shown in Figure 2 proved to be optimal due to the throughput requirements of each algorithm. The TA/ThA algorithm combined with the flight model, route planner, and main RDS task consume all of the processing capability of the first microVAX (the route planner executes before the flight simulation and therefore does not contend with TA/ThA). Analysis has shown that the bulk of processing on this microVAX is credited to the TA/ThA algorithm. The TF, SITAN and communication software load the second microVAX to 88.0 percent of its capability. If the ITARS Emulator is used instead of the Brass Board process, the microVAX becomes fully loaded. Based upon these estimates, the RDS fully loads both microVAX systems. Full real-time execution speed is achievable in a TF only configuration, however, with the addition of a third microVAX, full real-time execution speed could be achieved in a full-up configuration.

A larger than expected reduction in system throughput was noticed when the ITARS message monitoring mechanism was integrated into the system. This can be explained as follows: the main RDS task maintains a queue structure which collects arriving monitor messages from the Brass Board process. Each cycle through the simulation, this queue is emptied as each message is uploaded to the PC/AT. A time penalty is paid for this process resulting in a reduced overall hertz rate. A better idea would be to send a monitor message specifying number of area loads per unit period of time (i.e. 6 area loads/second). Data from this message would be used to render a gauge-type instrument on the PC/AT screen (bar chart).

Areas of Improvement

The system seems to perform as expected, however, minor modifications to the overall system architecture would improve system performance. One of these modifications would be to create a separate process for the aircraft state vector interpolation software. This software currently resides within the flight model and is interrupt driven (using a timer interrupt). Incorporation of the flightline PC software into the RDS would allow greater ITARS control from the RDS PC/AT. The ITARS system software could be improved by eliminating duplicate consecutive area loads. Currently, the ITARS sends area loads at a rate specified in the ITARS User Request Message. At the fastest rate (1 hz) several consecutive area loads will have identical data in them because the aircraft has not crossed

a 16 by 16 block boundary. This can also occur if the aircraft is in a tight turn. This data unnecessarily crowds the bandwidth of the ethernet and requires some additional processing time on the receiving microVAX. Currently, the Brass Board process detects duplicate consecutive area loads and discards them.

Conclusion

The ITARS Robust Demonstration System has proven to be more than a testbed for the ITARS. With its innovative user algorithms, elegant software partitioning, and clever communication software, the system provides a near real-time avionics environment for virtually any digital map storage system. In addition, the RDS can easily interface with other avionic subsystems, providing an incremental integration path from the lab environment to the aircraft environment. A high degree of independence exists between each of the user subsystems and brassboard interface, thus minimizing the difficulty of porting the software to various hardware configurations. Incorporating the user subsystems within the ITARS hardware would provide a truly self-contained, airborne TP/TA/TRA digital map navigation system.

Acknowledgments

The author wishes to thank the many people involved in the development and integration of the RDS software. To Richard McKenzie, who developed the flight model and also responsible for the overall structure of the system. To Dan Adams who wrote and improved the Route Planner and many thanks to Mark Newburn, whose thoroughness and assistance made the project a success. Thanks to Chuck Lau and Barry LaBoeuf for their administrative support. Thanks to Mark Walden and Ron Young at Hughes Aircraft, for their help and patience during system integration. To Mr. Don Small, program manager of the ITARS Program and Lt. Gordon Hengst of AFWAL/AAAS-3 who provided excellent guidance for the project.

Fractal Image Compression Using Iterated Transforms: Applications to DTED

E.W. Jacobs and R.D. Boss
NCCOSC RDT&E Div
Code 573, San Diego, CA 92152-5000

ABSTRACT: A review of iterated transformation image compression is presented. Generalization of simple iterated function system fractal generating algorithms to an automated iterated transformation algorithm used to compress greyscale images is reviewed. Compressed images from the Digital Terrain Elevation Database are presented, and compared with encodings using adaptive discrete cosine transformations, and mean residual vector quantization image compression techniques.

1. INTRODUCTION

Because of the increasing use of digital imagery, there is currently considerable interest in the image compression problem. In particular, image compression is a current and growing necessity for Navy applications including storage and transmittal of maps, intelligence photographs, weather information, etc. General interest in image compression has led to the establishment by the Joint Photographic Experts Group of a standard based on discrete cosine transforms (ADCT). There is also an on going effort in the research community to design improved vector quantization (VQ) methods, and to develop methods which utilize wavelet transformations. A relatively new approach to the image compression problem, iterated transformations, has been presented by Jacquin [1,2]. This method has its foundation in the theory of iterated function systems (IFSs), developed by Hutchinson [3] and Barnsley [4], and recurrent iterated function systems [5]. The iterated transform algorithm has received particular interest because of the *fractal* nature of the encoded images, and because there has been much speculation, but little information available on the capabilities of the method. The first sections of this paper review the basic methodology of the iterated transform image compression technique. This is followed by a section on the compression of the Digital Terrain Elevation Database (DTED) in which results obtained using iterated transformations are compared to ADCT and VQ methods.

2. BACKGROUND: SIMPLE EXAMPLES

This example serves as a simple illustration of some concepts involved in the iterated transform image-encoding scheme. This example is based on iterated function systems. The main concept is that the image of a set (a Sierpinski gasket, in this case) can be reconstructed from a set of transformations which may take less memory to store than the original image.

Consider the three transformations shown in figure 1. They are

$$w_1 \begin{bmatrix} x \\ y \end{bmatrix} = \begin{bmatrix} \frac{1}{2} & 0 \\ 0 & \frac{1}{2} \end{bmatrix} \begin{bmatrix} x \\ y \end{bmatrix} + \begin{bmatrix} 0 \\ 0 \end{bmatrix},$$

$$w_2 \begin{bmatrix} x \\ y \end{bmatrix} = \begin{bmatrix} \frac{1}{2} & 0 \\ 0 & \frac{1}{2} \end{bmatrix} \begin{bmatrix} x \\ y \end{bmatrix} + \begin{bmatrix} 0 \\ \frac{1}{2} \end{bmatrix},$$

and

$$w_3 \begin{bmatrix} x \\ y \end{bmatrix} = \begin{bmatrix} \frac{1}{2} & 0 \\ 0 & \frac{1}{2} \end{bmatrix} \begin{bmatrix} x \\ y \end{bmatrix} + \begin{bmatrix} \frac{1}{2} \\ 0 \end{bmatrix}.$$

For any set S , let

$$W(S) = \bigcup_{i=1}^3 w_i(S).$$

Denote the n -fold composition of W with itself as W^{*n} . Define $A_n = W(A_{n-1}) = W^{*n}(A_0)$ and arbitrarily choose A_0 as the unit square with lower left corner at the origin (i.e., $A_0 = \{(x, y) | 0 \leq x \leq 1, 0 \leq y \leq 1\}$). Then as $n \rightarrow \infty$, the set A_n converges to a limit set A_∞ . In fact, for any compact set $S \subset R^2$, $W^{*n}(S) \rightarrow A_\infty$ as $n \rightarrow \infty$. Figure 2 shows $A_0, A_1, A_2, A_3, A_4, A_5$ and A_∞ .

That all compact initial sets converge under iteration to A_∞ is important—it means that the set A_∞ is defined by the w_i only.

Each w_i is determined by 6 real values, so that for this example 18 floating point numbers are required. In single precision, this requires 72 bytes. The memory required to store an image of the set depends on the resolution; the

48.2.1

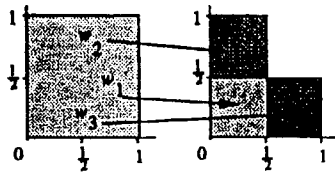

Figure 1. Three affine transformations in the plane.

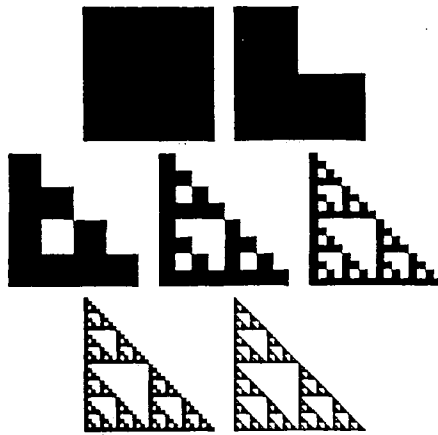

Figure 2. $A_0, A_1, A_2, A_3, A_4, A_5,$ and A_∞ .

A_∞ image requires $256 \times 256 \times 1 \text{ bit} = 8192$ bytes of memory. The resulting compression ratio in this example is 113.8:1.

It is inherently difficult to find an IFS which will encode an arbitrary set. Furthermore, in this example, the image of the Sierpinski gasket is described by a set of pixels, each being either black or white. The problem of more interest for image compression applications is the encoding of gray scale images (i.e., an image in which each pixel has many possible gray levels, not just black or white). There are two generalizations to the simple example given above which make encoding gray scale images feasible. First, instead of each w_i operating on the entire image, the w_i are restricted to operate on a section of the image. The theory of IFS's has been extended by Barnley and Jacquin [6] to allow transforms to operate on only parts of the set rather than the entire set, in a method they call recurrent iterated function systems. The particular section, or

domain, which each w_i acts on must be stored as part of the encoded image. Second, the transformations have to be generalized to three dimensions. A gray scale image can be thought of as a three-dimensional image, each pixel having an x, y coordinate, and an intensity value z . A form for the transformations which is convenient for encoding gray scale images is,

$$w_i \begin{bmatrix} x \\ y \\ z \end{bmatrix} = \begin{bmatrix} a_i & b_i & 0 \\ c_i & d_i & 0 \\ 0 & 0 & s_i \end{bmatrix} \begin{bmatrix} x \\ y \\ z \end{bmatrix} + \begin{bmatrix} e_i \\ f_i \\ \alpha_i \end{bmatrix} \quad (1)$$

Consider the sixteen transformations,

a	b	c	d	w	e	f	α
0.5	0.0	0.0	0.5	2.0	0.75	0.0	0.0
0.5	0.0	0.0	0.5	2.0	0.75	0.25	0.0
0.5	0.0	0.0	0.5	2.0	0.50	0.0	0.0
0.5	0.0	0.0	0.5	2.0	0.50	0.25	0.0
0.5	0.0	0.0	0.5	2.0	0.0	0.5	0.0
0.5	0.0	0.0	0.5	2.0	0.0	0.75	0.0
0.5	0.0	0.0	0.5	2.0	0.25	0.5	0.0
0.5	0.0	0.0	0.5	2.0	0.25	0.75	0.0
0.0	-0.5	0.5	0.0	0.25	0.25	-0.25	0.5
0.0	-0.5	0.5	0.0	0.25	0.25	0.0	0.25
0.0	-0.5	0.5	0.0	0.25	0.5	-0.25	0.25
0.0	-0.5	0.5	0.0	0.25	0.5	0.0	0.0
0.0	-0.5	0.5	0.0	0.25	0.75	0.25	0.0
0.0	-0.5	0.5	0.0	0.25	0.75	0.5	0.25
0.0	-0.5	0.5	0.0	0.25	1.0	0.25	0.25
0.0	-0.5	0.5	0.0	0.25	1.0	0.5	0.0

where the first eight transformations are restricted to act on the region $\{(x, y) | 0 \leq x \leq 1/2, 0 \leq y \leq 1/2\}$, and the second eight transformations are restricted to act on the region $\{(x, y) | 1/2 \leq x \leq 1, 0 \leq y \leq 1/2\}$. Similar to the example given above, the map W is defined as the union of the w_i 's. Let values of $x = 0$ be represented as black, $x = 1$ as white, with intermediate values as shades of gray. The initial image A_0 is arbitrarily chosen as $x = 0.5$ for $\{(x, y) | 0 \leq x \leq 1, 0 \leq y \leq 1\}$. The first six iterates, and the fixed point are shown in figure 3. In practice, the values of $x, y,$ and z are discretized. When the image in this example is discretized as 128×128 pixels, and 8-bits per pixel, the encoder used in this paper [6,7] automatically encodes this image (using an equivalent set of 16 transformations) with the resulting compression equal to 356:1.

3. ENCODING AND DECODING AN IMAGE

The question that must be answered is, given an image, what is the method for finding transformations that

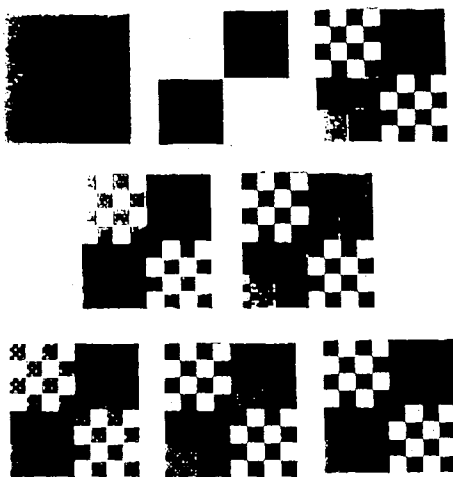

Figure 3. $A_0, A_1, A_2, A_3, A_4, A_5, A_6, A_7,$ and A_8 for the 16 transformations listed in the text.

encode it? The contractive mapping fixed point theorem suggest how to answer this question. The contractive mapping fixed point theorem guarantees that, if F is a complete metric space, and the map $W : F \rightarrow F$ is a *contractive transformation*, there exists a unique fixed point $|W| = A_\infty = \lim_{n \rightarrow \infty} W^n(A_0)$, for any $A_0 \in F$.

Since the limit set is a fixed point,

$$|W| = W(|W|) = w_1(|W|) \cup \dots \cup w_n(|W|). \quad (2)$$

This formula suggests how one would seek the transformations w_1, \dots, w_n which encode a given image. The goal is to have the fixed point $|W|$ approximate the desired image f . The transformations should therefore be chosen to satisfy equation 2 with $|W|$ replaced by f , i.e., the transformations, when applied to f , should result in f . The $w_1(f), \dots, w_n(f)$ are said to *cover* the image f . Referring back to the two examples in the previous section, it is seen that, given the Sierpinski triangle, or the fractal square pattern, by satisfying equation 2 the transformations encoding these images could be found.

In the two examples, the covering $W(f)$ is exact. Given an arbitrary set f , it is not possible in general to exactly cover f with a finite number of transformations of itself.

The obvious question is then: what happens if the covering $W(f)$ is approximate? A corollary of the contractive mapping fixed point theorem, which Barnsley calls the Collage Theorem, puts a bound on the error between $|W|$ and f when $W(f)$ does not exactly equal f . The theorem says that the closer the covering $W(f)$ is to the original set f , the closer the fixed point $|W|$ will be to f , and that this is especially true if the transformations composing W are very contractive.

In figure 4 part of the encoding process for this image is illustrated. The figure demonstrates how one section of the image, called a range (R_i), is covered as closely as possible by applying a transformation w_i to a domain (D_i). To complete the encoding process, a w_i and D_i must be found to cover each R_i , and the R_i 's must completely tile the image. To facilitate compact specification of the transformations, the sets from which D 's and R 's are chosen are restricted to be geometrically simple, and limited in number. The w_i 's must be chosen such that upon iteration, a fixed point is reached. In light of the collage theorem, it is surprising that when the map W is constructed, it is not necessary to impose any contractivity conditions on the individual transforms. The necessary contractivity requirement is that W be *eventually contractive* [8]. A map $W : F \rightarrow F$ is eventually contractive if there exists a positive integer m such that the m^{th} iterate of W is contractive. Note that in the gray scale example of section 2, half of the transformations are not contractive in the x direction.

As shown for the simple examples in the previous section (figures 2 and 3), decoding an image is performed by starting with an arbitrary initial image, and iterating the transformations until the fixed point is reached. This process is shown for an encoding of "tank farm" in figure 5. The compression of this image was 8.66:1, and the PSNR = $-20 \log \left(\frac{\text{rms error}}{255} \right) = 33.6$ dB.

4. APPLICATION TO DTED

Application of image compression to geographic map data is of particular interest to the Navy. Geographic map data comes in a variety of formats, and there has been extensive work done in compressing map databases for various applications. In this section, the problem of compress-

48.2.3

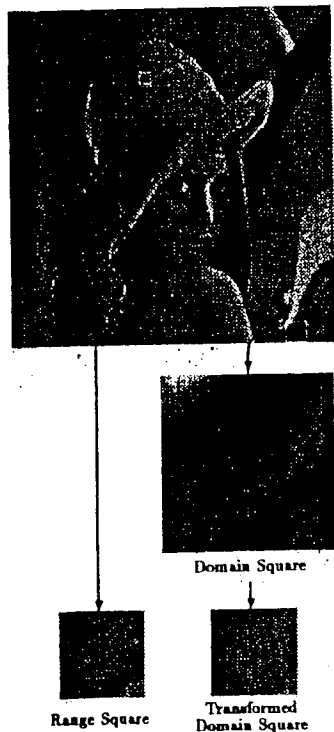

Figure 4. Part of the encoding process.

sion of the Digital Terrain Elevation Database (DTED) is addressed. The database consists of elevation data for a grid of longitude-latitude coordinates where the grid points are roughly 100 meters apart. A complete description of DTED can be obtained from the Defence Mapping Agency. Alward and Nicholls [9] examined hierarchical data structures as applied to DTED. The data structures result in some data compression, although compression was not the primary goal of that investigation. In this section, the problem of interest is evaluating the performance of the iterated transform (IT) method on DTED. This would be useful for applications where data compression is the primary concern, and issues such as hierarchical structure, access time, and decoding time are of secondary importance. As a means of evaluation, the DTED images

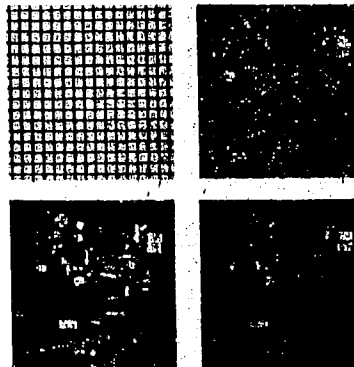

Figure 5. Initial image, first iterate, second iterate, and tenth iterate for an encoding of the "tank farm" image.

were also compressed with an ADCT and mean residual vector quantization algorithm (MRVQ). DTED data can be thought of in terms of a gray scale image where the longitude and latitude identify the pixel, and the elevation is the pixel value. For the purpose of possible Navy application, the data were transformed from their original linear scale between 0 and 10000 meters, to a logarithmic scale between 0 and 255. The quantization results in a compression from 14 bits per datapoint to 8 bits per datapoint. This logarithmic scale, shown in figure 6, represents lower elevations more accurately than higher elevations, the rationale for this being that lower elevations areas are more likely to be important for Navy applications, and that nearly all of the earth's surface (particularly near coastlines) is at relatively low elevation.

The iterated transform algorithm was identical to that used in reference 8 except for one significant modification. The algorithm was modified to encode sections of the image on coastlines with increased accuracy. For image sections that contained coastline, the error criteria was tightened. This resulted in more segmentation, and therefore higher fidelity in these areas. The ADCT algorithm used was similar to that described by Chen and Pratt [10], except for a modification similar to that described above for the iterated transform algorithm. To encode coastlines more accurately, the decision level quantiser table was compressed for sections of the image on coastlines. Improving the fidelity at the coastlines resulted in a

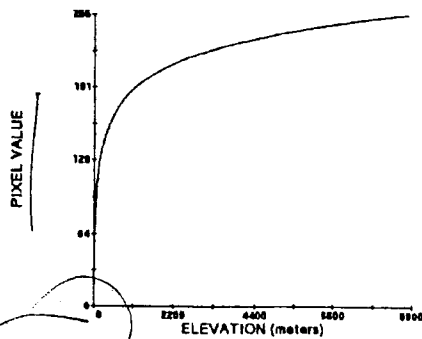

Figure 6 . The scale transformation used for the DTED data.

decrease in the overall compression-fidelity performance. The MRVQ algorithm used was based on the method described by Linde et al. [11]. Codebooks were generated from 2 sections of DTED similar to (but not including) the section tested.

The compression methods being considered are properly applied to images with a dynamic range appropriate to the number of bits used to store the image, and a relatively smooth distribution of gray level intensity values over this range. In figure 7, the 512 x 512 section of DTED, which is 1° east of that section shown in figure 8 is displayed where sea level is displayed in gray, all pixels with an elevation that is a multiple of 100 (± 2) are displayed in black, and all other elevations being displayed in white. It appears that the majority of the data contained in this section of DTED were created from 100-meter contour maps, the result being that a disproportionate number of datapoints are at multiples of 100 meters. In the southeast corner of the map, it can be seen that the number of points at 100 meters are far more dispersed. In this section of the map, roughly the number of datapoints that would be expected based on random elevations are present. The biased quantization illustrated by figure 7 is evident in other sections of DTED.

Because of this biased quantization, the reconstructed image resulting from compressed encodings will have a smoother distribution of pixel values than the original im-



Figure 7 . Pixels of value 100 ± 2 meters.

Table 1 . Results for encodings of figure 8.

Method	Compression	PSNR(dB)	Figure
IT	44.86:1	32.98	9
IT	21.49:1	35.08	
ADCT	47.33:1	30.51	10
ADCT	21.08:1	34.92	
MRVQ	32.00:1	31.36	11

Table 2 . Results for encodings of figure 12.

Method	Compression	PSNR(dB)	Figure
IT	104.11:1	34.09	13
IT	42.08:1	39.03	
ADCT	75.53:1	33.86	14
ADCT	43.76:1	38.14	
MRVQ	32.00:1	36.93	15

age. This will lead to an artificially poorer measured fidelity of the encoded images. In areas of DTED where the data are "properly" digitized, this situation will not occur. Because not all the data are quantized at a coarse resolution, but only most of it, taking advantage of this quantization is not simple. Although it has not been done here, before applying lossy compression techniques such as iterated transforms, ADCT, or VQ, requantization of the data in such a way that the majority of the datapoints retain their correct values could result in overall improved performance.

Tests in this section were performed on two 512 x 512



Figure 8 . Original 5° to 5° 25.6' E, 61° to 61° 12.8' N.

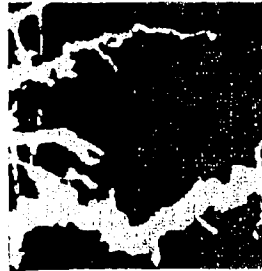

Figure 9 . The decoded IT image of figure 8.

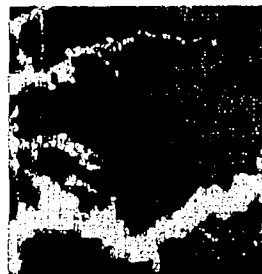

Figure 10 . The decoded ADCT image of figure 8.

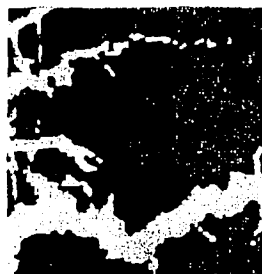

Figure 11 . The decoded MRVQ image of figure 8.



Figure 12 . Original 6° to 6° 25.6' E, 61° 12.8' to 61° 25.6' N.



Figure 13 . The decoded IT image of figure 12.



Figure 14 . The decoded ADCT image of figure 12.



Figure 15 . The decoded MRVQ image of figure 12.

sections located in the fiords of Norway. These test images are shown in figures 8 and 12. Figure 8 covers the section of the earth from 5° to 5° 25.6' east and 61° to 61° 12.8' north and figure 12 the section from 6° to 6° 25.6' east and 61° 12.8' to 61° 25.6' north. These sections of DTED were chosen because the topology of the fiords served as a severe test of the fidelity of the compression methods. A more thorough study where a broad area of the database containing a representative amount of flat and mountainous regions would be necessary in determining the compression and fidelity possible for the complete database.

Figures 9, 10, and 11 show gray scale reconstructed images from typical encodings of the image in figure 8 using iterated transforms, ADCT, and MRVQ respectively. Similarly, figures 13, 14, and 15 show reconstructed images from encodings of the image in figure 12. The fidelity and compression of these (and other) encodings are summarized in tables 1 and 2.

5. CONCLUSIONS

The compression versus fidelity results indicate that the iterated transform algorithm performed well when compared with the ADCT and MRVQ methods. Other important factors to consider when comparing these compression algorithms are access time, decoding time, and encoding time. Iterated transforms, along with ADCT are variable bit-rate methods, which would result in slower access times than the fixed bit rate MRVQ algorithm. Iterated transform encoding requires an extensive search procedure, making it slower than MRVQ, which also requires a search, albeit a shorter one. Iterated transform encoding is also slower than ADCT, which requires only a transformation and quantization. For most applications, encoding would be a one-time procedure; therefore, encoding time would not necessarily be an important concern. If an application required all or a large fraction of DTED be encoded, then the computer costs for encoding become significant. For many applications, the speed of decoding an image might be a critical requirement. The decoding for iterated transforms is a simple iteration, making it faster than ADCT (where decoding takes as long as encoding), and slower than MRVQ, which is essentially a table lookup.

6. REFERENCES

- [1] A.E. Jacquin, "A Fractal Theory of Iterated Markov Operators, with Applications to Digital Image Coding," Ph.D. Thesis, Department of Mathematics, Georgia Institute of Technology, (1989).
- [2] A.E. Jacquin, "Fractal Image Coding Based on a Theory of Iterated Contractive Image Transformations," *SPIE Visual Comm. and Image Processing '90*, Vol. 1360, pp. 227-230, (1990).
- [3] J.E. Hutchinson, "Fractals and Self-Similarity," *Indiana University Mathematics Journal*, vol. 35, p. 5, (1981).
- [4] M.F. Barnsley, *Fractals Everywhere*, Academic Press, Inc., San Diego, CA, (1988).
- [5] M.F. Barnsley and A.E. Jacquin, "Application of Recurrent Iterated Function Systems to Images," *SPIE vol. 1001, Visual Comm. and Image Processing*, p. 122, (1988).
- [6] E.W. Jacobs, Y. Fisher, and R.D. Boss, "Image Compression: A Study of the Iterated Transform Method" to be published in *Signal Processing*, vol. 29 no. 3.
- [7] R.D. Boss and E.W. Jacobs, "Studies of Iterated Transform Image Compression, and its Application to Color and DTED," NOSC TR 1468, December 1991.
- [8] Y. Fisher, E.W. Jacobs, and R.D. Boss, "Fractal Image Compression Using Iterated Transforms," submitted for publication in *Data Compression*, J.A. Storer (ed.), Kluwer Academic Publishers, Norwell, MA, (1991).
- [9] Alward, H.L. and D.A. Nicholls, "Hierarchical Data Structures for a Digital Terrain Map System," AFWAL-TR-86-1177, (1986), available from DTIC.
- [10] W. Chen and W.K. Pratt, "Scene Adaptive Coder," *IEEE Transactions on Communications*, vol. 32, pp. 225-232, (1984).
- [11] Y. Linde, A. Buzo, and R.M. Gray, "An Algorithm for Vector Quantizer Design," *IEEE Trans. on Comm.*, vol. COM-28, no. 1, pp. 84-95, (1980).

08/513,298



UNITED STATES DEPARTMENT OF COMMERCE
Patent and Trademark Office
Address: COMMISSIONER OF PATENTS AND TRADEMARKS
Washington, D.C. 20231

APB

SERIAL NUMBER	FILING DATE	FIRST NAMED APPLICANT	ATTORNEY DOCKET NO.
08/513,298	08/09/95	MARGOLIN	

EDWIN H TAYLOR
BLARELY BOROLOFF TAYLOR & ZAFSON
12400 WILSHIRE BLVD SEVENTH FLOOR
LOS ANGELES CA 90025

B3M170315

EXAMINER	
NGUYEN, J	
ART UNIT	PAPER NUMBER
	16

DATE MAILED: 03/15/96

EXAMINER INTERVIEW SUMMARY RECORD

All participants (applicant, applicant's representative, PTO personnel):

03/15/96

- (1) DAN DEVAS (3) _____
 (2) TAN NGUYEN (4) _____

Date of interview 03/08/96 and 03/14/96

Type: Telephonic Personal (copy is given to applicant applicant's representative).

Exhibit shown or demonstration conducted: Yes No. If yes, brief description: _____

Agreement was reached with respect to some or all of the claims in question. was not reached.

Claims discussed: _____

Identification of prior art discussed: BINESKY, WLAICH, RAYMER ET AL, JACOBS ET AL, PATRICK

Description of the general nature of what was agreed to if an agreement was reached, or any other comments: the applicant's representative argued that some of the references disclose 3c terrain data, representing real terrain terrestrial terrain as at least one polygon, is generated from elevation data. Examiner agreed to reconsider the application in light of the argument. However, no written amendment is requested in order for examiner to respond.

(A fuller description, if necessary, and a copy of the amendments, if available, which the examiner agreed would render the claims allowable must be attached. Also, where no copy of the amendments which would render the claims allowable is available, a summary thereof must be attached.)

Unless the paragraphs below have been checked to indicate to the contrary, A FORMAL WRITTEN RESPONSE TO THE LAST OFFICE ACTION IS NOT WAIVED AND MUST INCLUDE THE SUBSTANCE OF THE INTERVIEW (e.g., items 1-7 on the reverse side of this form). If a response to the last Office action has already been filed, then applicant is given one month from this interview date to provide a statement of the substance of the interview.

It is not necessary for applicant to provide a separate record of the substance of the interview.

Since the examiner's interview summary above (including any attachments) reflects a complete response to each of the objections, rejections and requirements that may be present in the last Office action, and since the claims are now allowable, this completed form is considered to fulfill the response requirements of the last Office action.

Tan Nguyen
Examiner's Signature

01415

17/E
PL
4-22

02055.P002C

IN THE UNITED STATES PATENT AND TRADEMARK OFFICE

<p>In re Application of: Jed Margolin</p> <p>Application No.: 08/513,298</p> <p>Filed: August 9, 1995</p> <p>For: Pilot Aid Using Synthetic Reality</p>
<p>This is a Continuation of: Serial No: 08/274,394 Filed: July 11, 1994</p>

OFFICIAL

Examiner: Nguyen, T.

Art Unit: 2304

Hon. Commissioner of Patents and Trademarks
Washington, D.C. 20231

AMENDMENT AND REMARK

Sir:

This amendment and remark is responsive to the Examiner Interview Summary mailed on March 15, 1996 and the telephonic interview with the Examiner on April 18, 1996. During the interview on April 18, 1996, the Examiner indicated that the application would be allowed if a response was filed with the remark contained below. Although the Examiner and Applicant did not discuss the following amendments, Applicant believes these amendments have no affect on the allowability of this case. If the Examiner determines that these amendments affect the allowability of this case, Applicant requests the Examiner contact the Applicant. Applicant would like to thank the Examiner for the thorough search performed in this case, as well as the Examiner's effort in understanding the invention claimed. Applicant looks forward to receiving the notice of allowance in the next couple of weeks.

I hereby certify that this correspondence is being transmitted by facsimile to the United States Patent and Trademark Office in accordance with 37 CFR § 1.6(d), on the date shown below.

Name: Connie West

Signature: Connie West

Date: April 19, 1996

AMENDMENT*In the Claims:*

- Please replace "23" in line 1 of claim 31 with --38--.
Please replace "23" in line 1 of claim 32 with --38--.
Please delete "by" from the last line of claim 39.

REMARK

Claims 1-28 and 31-39 remain in the application. No claims have been canceled.
Claims 31 and 32 have been amended.

Prior to this amendment, claims 31 and 32 were mistakenly left dependent upon the wrong claim. By this amendment, claims 31 and 32 are now dependent on allowable claim 38. For the Examiner's convenience, Applicant points out that claims 33 and 35 are dependent on claim 31, while claim 34 is dependent on claim 32. If the Examiner determines that these amendments affect the allowability of this case, Applicant requests the Examiner contact the Applicant, who will promptly fix or cancel these claims.

35 U.S.C. §103 rejection, over Beckwith in view of Behensky

The Examiner has rejected Claims 1-12, 14-28, and 31-39 under 35 U.S.C. §103 as being obvious over Beckwith, et al. ("Beckwith") in view of Behensky, et al. ("Behensky") or a brochure from Atari Game Corp. (Hard Driving) or a brochure from Atari Game Corp. (Steel Talons) and further in view of Ulrich, or Jacobs et al., or Raymer et al. or Patrick. As to Beckwith, Behensky, and the two Atari brochures, the Applicant incorporates herein by reference the arguments made in the Response After Final submitted in the parent application on July 10, 1995, and entered in this application by the Preliminary Amendment filed on October 18, 1995. As stated in the Response filed on July 10, 1995, the Beckwith, Behensky, and two Atari Game Corp. brochures, taken individually or in combination, do not teach or make obvious a polygon database

01417

representing real terrestrial terrain where that polygon database was generated from elevation data of real terrestrial terrain (see Claim 1, 7, and 36). As agreed upon by the Examiner and Applicant, Ulrich, Jacobs et al., Raymer et al., and Patrick, taken individually or in combination, also do not teach or make obvious the polygon database contained in claims 1, 7, and 36. Since none of the references cited in this rejection, individually or in combination, teach or make obvious the invention as claimed, Applicant respectfully requests the Examiner allow claims 1, 7, and 36 as agreed upon by the Examiner and Applicant. Although Applicant argues around references cited in this rejection, Applicant does not concede that there is a suggestion to combine these references.

Claims 2-6, 8-12, 14-15, 17-18, 20-21, 23-24, 26-28, 31-35, and 37-39 of Applicant's present invention are each dependent on one of allowable base claims 1, 7, and 36. For at least these reasons, it is respectfully submitted that the rejected claims are allowable over the cited prior art.

35 U.S.C. §103 rejection, over Beckwith in view of Behensky, and further in view of the sales brochure from the Polhemus Company

The Examiner has rejected Claim 13 under 35 U.S.C. §103 as being obvious over Beckwith and Behensky in view of the sales brochure from the Polhemus Company. As previously stated, the Beckwith and Behensky references, taken individually or in combination, do not teach or make obvious a polygon database representing real terrestrial terrain where that polygon database is generated from elevation data of real terrestrial terrain (see Claim 13). As stated in the Office Action mailed January 22, 1996, the sales brochure from the Polhemus Company "suggests the commercial available [sic] of a position and orientation sensor which can be used on a head mounted display". The brochure from Polhemus Company clearly does not teach or make obvious the above-described polygon database. Since none of the references cited in this rejection, individually or in combination, teach or make obvious the invention as claimed, Applicant respectfully

request the Examiner allow claim 13 as agreed upon by the Examiner and Applicant. Although Applicant argues around references cited in this rejection, Applicant does not concede that there is a suggestion to combine these references.

Claims 16, 19, 22, and 25 are each dependent on independent claim 13. For at least these reasons, it is respectfully submitted that these rejected claims are allowable over the cited prior art.

Conclusion

As agreed upon by the Examiner and the Applicant, the rejections have been overcome and the claims are now in condition for allowance. Accordingly, Applicant respectfully requests reconsideration of this application, withdrawal of the objection, and allowance of the claims.

Invitation for a telephone interview

The Examiner is invited to call the undersigned at 408-720-8598 if there remains any issue with allowance of this case.

Charge our Deposit Account

Please charge any shortage to our Deposit Account No. 02-2666.

Respectfully submitted,

BLAKELY, SOKOLOFF, TAYLOR & ZAFMAN

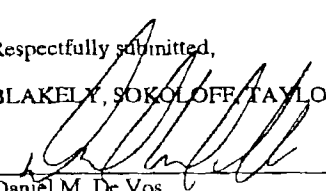
Daniel M. De Vos
Reg. No. 37,813

Date: 4/18, 1996

12400 Wilshire Boulevard
Seventh Floor
Los Angeles, California 90025-1026
(408) 720-8598

**BLAKELY
SOKOLOFF
TAYLOR &
ZAFMAN**

1279 Oakmead Parkway
Sunnyvale, California 94086
(408) 720-8598 Telephone
(408) 720-9397 Facsimile

A Partnership Including
Law Corporations

Facsimile Transmittal Sheet

Date: 04/19/96

OFFICIAL

URGENT

Deliver to: Tan Nguyen

Fax No. (703) 308-5358

FROM BSTZ:

From: Daniel De Vos
Operator: Connie West
Page 1 of 5

To Firm: U.S. PATENT AND TRADEMARK OFFICE

Phone:

Your Ref: Applic. No.: 08/513,298

Our Ref: 002055.P002C

Title: Pilot Aid Using Synthetic Reality

Message:

Enclosed please find an Amendment and Remark responsive to the Examiner Interview Summary mailed on 3-15-96 and the telephonic interview with the Examiner on 4-18-96.

CONFIDENTIALITY NOTE

The documents accompanying this facsimile transmission contain information from the law firm of Blakely Sokoloff Taylor & Zafman which is confidential or privileged. The information is intended to be for the use of the individual or entity named on this transmission sheet. If you are not the intended recipient, be aware that any disclosure, copying, distribution or use of the contents of this faxed information is prohibited. If you have received this facsimile in error, please notify us by telephone immediately so that we can arrange for the retrieval of the original documents at no cost to you.

IF YOU EXPERIENCE ANY DIFFICULTY IN RECEIVING THE ABOVE PAGES, PLEASE CALL (408) 720-8598 AND ASK FOR THE OPERATOR NAMED ABOVE.

01420

18/513, 298



UNITED STATES DEPARTMENT OF COMMERCE
Patent and Trademark Office
Address: COMMISSIONER OF PATENTS AND TRADEMARKS
Washington, D.C. 20231

SERIAL NUMBER	FILING DATE	INVENTOR FIRST NAMED APPLICANT	CLASSIFICATION
---------------	-------------	--------------------------------	----------------

NGUYEN, T

B3M1/0418

EXAMINER

EDWIN H TAYLOR
BLANKELY SOLOLOFF TAYLOR & ZAFAR
12400 WILSHIRE BLVD SEVENTH FLOOR
LOS ANGELES CA 90025

ART UNIT	PAPER NUMBER
----------	--------------

02/18/96

DATE MAILED:

NOTICE OF ALLOWABILITY

PART I

- This communication is responsive to the amendment filed on 07/19/96
- All the claims being allowable, PROSECUTION ON THE MERITS IS (OR REMAINS) CLOSED in this application. If not included herewith (or previously mailed), a Notice Of Allowance And Issue Fee Due or other appropriate communication will be sent in due course.
- The allowed claims are 1-28 31-39 (now renumbered as 1-37)
- The drawings filed on 02/13/95 are acceptable.
- Acknowledgment is made of the claim for priority under 35 U.S.C. 119. The certified copy has [] been received, [] not been received, [] been filed in parent application Serial No. _____, filed on _____.
- Note the attached Examiner's Amendment
- Note the attached Examiner Interview Summary Record, PTO-413.
- Note the attached Examiner's Statement of Reasons for Allowance
- Note the attached NOTICE OF REFERENCES CITED, PTO-892.
- Note the attached INFORMATION DISCLOSURE CITATION, PTO-1449

PART II

A SHORTENED STATUTORY PERIOD FOR RESPONSE to comply with the requirements noted below is set to EXPIRE THREE MONTHS FROM THE "DATE MAILED" indicated on this form. Failure to timely comply will result in the ABANDONMENT of this application. Extensions of time may be obtained under the provisions of 37 CFR 1.136(a).

- Note the attached EXAMINER'S AMENDMENT or NOTICE OF INFORMAL APPLICATION, PTO-152, which discloses that the oath or declaration is deficient. A SUBSTITUTE OATH OR DECLARATION IS REQUIRED.
- APPLICANT MUST MAKE THE DRAWING CHANGES INDICATED BELOW IN THE MANNER SET FORTH ON THE REVERSE SIDE OF THIS PAPER.
 - Drawing informalities are indicated on the NOTICE RE PATENT DRAWINGS, PTO-948, attached hereto or to Paper No. _____ CORRECTION IS REQUIRED.
 - The proposed drawing correction filed on _____ has been approved by the examiner. CORRECTION IS REQUIRED.
 - Approved drawing corrections are described by the examiner in the attached EXAMINER'S AMENDMENT. CORRECTION IS REQUIRED.
 - Formal drawings are now REQUIRED.

Any response to this letter should include in the upper right hand corner, the following information from the NOTICE OF ALLOWANCE AND ISSUE FEE DUE: ISSUE BATCH NUMBER, DATE OF THE NOTICE OF ALLOWANCE, AND SERIAL NUMBER.

Attachments:

- Examiner's Amendment
- Examiner Interview Summary Record, PTO-413
- Reasons for Allowance
- Notice of References Cited, PTO-892
- Information Disclosure Citation, PTO-1449
- Notice of Informal Application, PTO-152
- Notice re Patent Drawings, PTO-948
- Listing of Bowled Draftsman
- Other

[Handwritten Signature]
 TAYLOR
 EDWIN H TAYLOR
 SUPPLEMENTAL EXAMINER
 02/18/96

01421

Serial No.: 08/513,298
Art Unit: 2304

2

I. **EXAMINER'S STATEMENT OF REASONS FOR ALLOWANCE**

II. This communication is an Examiner's reasons for allowance in response to application filed on August 09, 1995, assigned serial 08/513,298 and titled "PILOT AIDED USING SYNTHETIC REALITY".

III. The following is an Examiner's statement of reasons for the indication of allowable subject matter:

1. After carefully reviewing the application in light of the prior art of record, the amended claims and additional search of all the possible areas relevant to the present application a set of related prior art have been found, but those prior art references are not deemed strong to make the application unpatentable. Thus, it is found that the application is now in condition for allowance.

2. Although the prior art disclose several claimed limitations, none of the references teach a pilot aid which uses an aircraft's position and attitude to transform data from a digital data base to present a pilot with a synthesized three dimensional projected view of the world which includes a digital data base comprising terrain data representing real terrestrial terrain as at least one polygon and said terrain data generated from elevation data of the real terrestrial terrain (claims 1, 7, 13 and 36).

01422

Serial No.: 08/513,298
Art Unit: 2304

3

3. The closest references have been found were Beckwith et al., Behensky et al., Ulrich , Jacobs et al., Raymer et al., Patrick. However, taken individually or in combination, they do not teach or make obvious a polygon database representing real terrestrial terrain where that polygon database was generated from elevation data of real terrestrial terrain.

4. Claims 1-28 and 31-39 are allowable over the prior art of record (now renumbered as 1-37).

IV. Any inquiry concerning this communication or earlier communications from the examiner should be directed to examiner Tan Nguyen, whose telephone number is (703) 305-9755. The examiner can normally be reached on Monday-Thursday from 7:30 AM-6:00 PM.

If attempts to reach the examiner by telephone are unsuccessful, the examiner's supervisor, Kevin J. Teska, can be reached on (703) 305-9704. The fax phone number for this Group is (703) 305-9564.

Any inquiry of a general nature or relating to the status of this application should be directed to the Group receptionist whose telephone number is (703) 305-3800.



TAN NGUYEN
Patent and Trademark Office
Alexandria, Virginia

TAN NGUYEN
June 17, 1996

01423



UNITED STATES DEPARTMENT OF COMMERCE
Patent and Trademark Office

Address: Box ISSUE FEE
COMMISSIONER OF PATENTS AND TRADEMARKS
Washington, D.C. 20231

NOTICE OF ALLOWANCE
AND ISSUE FEE DUE

- Note attached communication from the Examiner
- This notice is issued in view of applicant's communication filed _____

SERIES CODE/SERIAL NO.	FILING DATE	TOTAL CLAIMS	EXAMINER AND GROUP ART UNIT	DATE MAILED
First Named Applicant				

TITLE OF INVENTION

ATTY'S DOCKET NO.	CLASS-SUBCLASS	BATCH NO.	APPLN. TYPE	SMALL ENTITY	FEE DUE	DATE DUE

THE APPLICATION IDENTIFIES ABOVE HAS BEEN EXAMINED AND IS ALLOWED FOR ISSUANCE AS A PATENT. PROSECUTION ON THE MERITS IS CLOSED.

THE ISSUE FEE MUST BE PAID WITHIN THREE MONTHS FROM THE MAILING DATE OF THIS NOTICE OR THIS APPLICATION SHALL BE REGARDED AS ABANDONED. THIS STATUTORY PERIOD CANNOT BE EXTENDED.

HOW TO RESPOND TO THIS NOTICE:

- I. Review the SMALL ENTITY Status shown above.
 - If the SMALL ENTITY is shown as YES, verify your current SMALL ENTITY status:
 - A. If the status is changed, pay twice the amount of the FEE DUE shown above and notify the patent and Trademark Office of the change in status, or
 - B. If the Status is the same, pay the FEE DUE shown above.
 - If the SMALL ENTITY is shown as NO:
 - A. Pay FEE DUE shown above, or
 - B. File verified statement of Small Entity Status before, or with, pay of 1/2 the FEE DUE shown above.
 - II. Part B of this notice should be completed and returned to the Patent and Trademark Office (PTO) with your ISSUE FEE. Even if the ISSUE FEE has already been paid by charge to deposit account, Part B should be completed and returned. If you are charging the ISSUE FEE to your deposit account, Part C of this notice should also be completed and returned.
- All communications regarding this application must give series code (or filing date), serial number and batch number. Please direct all communication prior to issuance to Box ISSUE FEE unless advised to contrary.

IMPORTANT REMINDER: Patents issuing on applications filed on or after Dec. 12, 1980 may require payment of maintenance fees. It is patentee's responsibility to ensure timely payment of maintenance fees when due.

01424

PART B—ISSUE FEE TRANSMITTAL

242-625
561-303

MAILING INSTRUCTIONS: This form should be used for transmitting the ISSUE FEE. Blocks 2 through 6 should be completed where appropriate. All further correspondence including the Issue Fee Receipt, the Patent, advance orders and notification of maintenance fees will be mailed to addressee entered in Block 1 unless you direct otherwise, by: (a) specifying a new correspondence address in Block 3 below; or (b) providing the PTO with a separate "FEE ADDRESS" for maintenance fee notifications with the payment of Issue Fee or thereafter. See reverse for Certificate of Mailing.

1. CORRESPONDENCE ADDRESS		2. INVENTOR(S) ADDRESS CHANGE (Complete only if there is a change)	
EDWIN H. TAYLOR BLAKELY, SOKOLOFF, TAYLOR & ZAFMAN 12100 WILSHIRE BLVD SEVENTH FLOOR LOS ANGELES CA 90025		INVENTOR'S NAME	
		Street Address	
		City, State and ZIP Code	
		CO-INVENTOR'S NAME	
		Street Address	
		City, State and ZIP Code	
<input type="checkbox"/> Check if additional changes are on reverse side			

RECEIVED
JUN 24 1996

SERIES CODE/SERIAL NO.	FILING DATE	TOTAL CLAIMS	EXAMINER AND GROUP ART UNIT	DATE MAILED
		BLAKELY, SOKOLOFF, TAYLOR & ZAFMAN		
		LOS ANGELES		
First Named Applicant				
TITLE OF INVENTION				

PILOT AND USING SYNTHETIC REALITY ENVIRONMENT

ENTERED BY 5/9/95 OFFICE ACTION
IN PARENT CASE (APR 08/214,394)

ATTY'S DOCKET NO.	CLASS-SUBCLASS	BATCH NO.	APPLN. TYPE	SMALL ENTITY	FEE DUE	DATE DUE

3. Correspondence address change (Complete only if there is a change)	4. For printing on the patent front page, list the names of not more than 3 registered patent attorneys or agents OR, alternatively, the name of a firm having as a member a registered attorney or agent. If no name is listed, no name will be printed.
	Blakely, Sokoloff, Taylor & Zafman

DO NOT USE THIS SPACE

040 WI 07/12/96 08513298	1 242	825.00 CK
040 WI 07/12/96 08513298	1 561	30.00 CK

5. ASSIGNMENT DATA TO BE PRINTED ON THE PATENT (print or type)

(1) NAME OF ASSIGNEE:

(2) ADDRESS: (CITY & STATE OR COUNTRY)

A. This application is NOT assigned.
 Assignment previously submitted to the Patent and Trademark Office.
 Assignment is being submitted under separate cover. Assignments should be directed to Box ASSIGNMENTS.
 PLEASE NOTE: Unless an assignee is identified in Block 5, no assigned date will appear on the patent. Inclusion of assignee data is only appropriate when an assignment has been previously submitted to the PTO or is being submitted under separate cover. Completion of this form is NOT a substitute for filing an assignment.

B. The following fees are enclosed:
 Issue Fee Advance Order - # of Copies ten (10)

6b. The following fees should be charged to:
 DEPOSIT ACCOUNT NUMBER 02-2666
 (ENCLOSE PART C)
 Issue Fee Advance Order - # of Copies _____
 Any Deficiencies in Enclosed Fees

The COMMISSIONER OF PATENTS AND TRADEMARKS is requested to apply the Issue Fee to the application identified above.

(Authorized Signature) _____ (Date) 6/26/96
Daniel H. De Vos Reg. No 37,813

NOTE: The Issue Fee will not be accepted from anyone other than the applicant, a registered attorney or agent, or the assignee or other party in interest as shown by the records of the Patent and Trademark Office.

L. TRANSMIT THIS FORM WITH FEE CERTIFICATE OF MAILING ON REVERSE

01423

PART C—CHARGE TO DEPOSIT ACCOUN

342-620
561-30

1. CORRESPONDENCE ADDRESS

INVENTOR: TAYLOR & CLIPMAN
1740 WASHINGTON BLVD WASHINGTON DC 20001

I hereby certify that this correspondence is being deposited with the United States Postal Service as first class mail with sufficient postage in an envelope addressed to the Commissioner of Patents and Trademarks, Washington, D.C. 20231

on June 26, 1996
Name of Person Making Correspondence
CONNIE WEST
Address Washington Division

SERIES CODE/SERIAL NO.	FILING DATE	TOTAL CLAIMS	EXAMINER AND GROUP ART UNIT	DATE MAILED
			JUL 01 1996	
First Named Applicant			GP	

TITLE OF INVENTION
METHOD AND APPARATUS FOR CONTROLLING THE OPERATION OF A MOTOR

ATTY'S DOCKET NO.	CLASS-SUBCLASS	BATCH NO.	APPLN. TYPE	SMALL ENTITY	FEE DUE	DATE DUE

DO NOT USE THIS SPACE

[Handwritten scribbles]

2a. The following fees are enclosed:
 Issue Fee Advance Order - # of Copies Fee (10)

2b. The following fees should be charged to:
DEPOSIT ACCOUNT NUMBER 02-2666

Issue Fee Advance Order - # of Copies
 Any Deficiencies in Enclosed Fees

The COMMISSIONER OF PATENTS AND TRADEMARKS is requested to apply the Issue Fee to the application identified above.
(Authorized Signature)

Daniel M. de Vries Reg. No. 37,813 6/26/96
Date

NOTE: The Issue Fee will not be accepted from anyone other than the applicant, a registered attorney or agent, or the assignee or other party in interest as shown by the records of the Patent and Trademark Office.

2. TRANSMIT THIS FORM WITH PART B WHEN AUTHORIZING USE OF A DEPOSIT ACCOUNT



UNITED STATES DEPARTMENT OF COMMERCE
Patent and Trademark Office

ASSISTANT SECRETARY AND COMMISSIONER
OF PATENTS AND TRADEMARKS
Washington, D.C. 20231

CHANGE OF ADDRESS/POWER OF ATTORNEY

FILE LOCATION 9200 SERIAL NUMBER 08513298 PATENT NUMBER 5566073

THE CORRESPONDENCE ADDRESS HAS BEEN CHANGED TO CUSTOMER # 23497

THE FEE ADDRESS HAS BEEN CHANGED TO CUSTOMER # 23497

ON 08/11/00 THE ADDRESS OF RECORD FOR CUSTOMER NUMBER 23497 IS:

JED MARGOLIN
3570 PLEASANT ECHO DRIVE
SAN JOSE CA 95148-1916

PTO INSTRUCTIONS: PLEASE TAKE THE FOLLOWING ACTION WHEN THE
CORRESPONDENCE ADDRESS HAS BEEN CHANGED TO CUSTOMER NUMBER:
RECORD, ON THE NEXT AVAILABLE CONTENTS LINE OF THE FILE JACKET,
'ADDRESS CHANGE TO CUSTOMER NUMBER'. LINE THROUGH THE OLD
ADDRESS ON THE FILE JACKET LABEL AND ENTER ONLY THE 'CUSTOMER
NUMBER' AS THE NEW ADDRESS. FILE THIS LETTER IN THE FILE JACKET.
WHEN ABOVE CHANGES ARE ONLY TO FEE ADDRESS AND/OR PRACTITIONERS
OF RECORD, FILE LETTER IN THE FILE JACKET.
THIS FILE IS ASSIGNED TO GAU 2304.

01927

Serial No.: 08/513,298
Art Unit: 2304

3

section where the subject matter and the claimed invention were, at the time the invention was made, owned by the same person or subject to an obligation of assignment to the same person. 17-28, 31-35 and 38-39

5. Claims 1-12, 14-28 and 31-39 are rejected under 35 U.S.C. § 103 as being unpatentable over Beckwith et al (4,660,157) in view of Behensky et al. (5,005,148) or a brochure from Atari Game Corp. (Hard Driving') or a brochure from Atari Game Corp. (Steel Talons) and further in view of Ulrich (an article entitle "Tactical Mapping in Combat Aircraft"), or Jacobs et al. (an article entitle "Fractal Image Compression Using Iterated Transforms Applications To DTED"), or Raymer et al. (Advance Terrain Data Processor), or Patrick (Itars Robust Demonstration System Integration).

5.1. With respect to claims 1, 5-7, 11-12, 14-16 and 36-37, Beckwith et al. discloses a digital system for producing a real time video display in perspective of terrain over which an aircraft is passing on the basis of compressed digital data stored on a cassette tape (see at least an abstract). Beckwith et al. discloses that the system includes a position determining means for locating the aircraft's position in three dimensions and an attitude determining means for determining the aircraft's orientation in three dimensional space (see at least figure 1 and columns 5 and 6). Beckwith et al. further discloses that the system includes a digital data base means for storing a compressed terrain data (see at least the abstract). Beckwith et al. also discloses a computer means for reading compressed

01428

Serial No.: 08/513,298
Art Unit: 2304

4

terrain data from the digital data base means in a controlled manner based on the instantaneous geographical of the aircraft as provided by the aircraft navigation computer system, reconstructing the compressed data by suitable processing and writing the reconstructed data into a scene memory, and then providing a 3D perspective on the display (see at least columns 2 and 3).

Beckwith et al. does not explicitly disclose that a digital data base means containing polygon data representing terrain and manmade structures. However, Behensky et al. suggests a driving simulator for a video game which includes the road and other terrain are produced by mathematically transforming a three-dimensional polygon data base (see at least column 2, lines 33-38). The suggestion of Behensky et al. in at least column 2 would have motivated one of ordinary skill in the art to combine with the system of Beckwith et al. in order to provide a significant reduction of data base storage and a larger geographic areas can be stored so that it is not necessary to generate a data base of each mission. Similarly, the digital data base means containing polygon data representing terrain and manmade structures is also taught in a brochure from Atari Game Corp. ('Hard Driving') or a brochure from Atari Game Corp. ('Steel Talons').

Behensky et al., the brochures of Atari Game Corp. do not explicitly disclose that the terrain data is generated from

01429

Serial No.: 08/513,298
Art Unit: 2304

5

elevation data of the real terrestrial terrain. However, the feature is well known and old (see Ulrich, Raymer et al., Jacobs et al., and Patrick, for examples). It would have been obvious to one of ordinary skill in the art at the time the invention was made to incorporate the teaching of Ulrich, Raymer et al., Jacobs et al., and Patrick with the system of Beckwith in order to improve the system for pilot aid by providing displaying large quantities of cartographic and mission data including terrain elevation data and cultural feature data.

Thus, because of the motivation set forth above, it would have been obvious to a person of ordinary skill in the art at the time the invention was made to combine the teachings of Behensky et al. or the brochure from Atari Game Corp. ('Hard Driving') or the brochure from Atari Game Corp. (Steel Talons) with the system of Beckwith et al., and Ulrich, Raymer et al. or Jacobs et al. or Patrick.

5.2. With respect to claims 2-3 and 8-9, Beckwith et al. discloses the claimed invention as discussed above but does not explicitly disclose that the position determining means comprises a standard system for retrieving and processing data from the global positioning system and the attitude determining means comprises a standard avionics systems. However, the use of the standard system for retrieving and processing data from global positioning system and the standard avionics systems are well known effective and efficient means for determining the

01430

Serial No.: 08/513,298
Art Unit: 2304

6

position and the orientation of the aircraft. For examples, the Maher patent (4,485,383) shows a receiver for receiving global positioning system and the Timothy patent shows a method for determining the orientation of a moving object from a single GPS receiver and producing roll, pitch, and yaw information. It would have been obvious to one of ordinary skill in the art at the time of the invention to utilize the global positioning system and the standard avionics system in such a system as taught through Beckwith et al. because it would produce high degree of accuracy in determining the position and orientation of the aircraft including roll, pitch, and yaw information.

5.3. With respect to claims 4 and 10, Beckwith et al. does not specifically disclose that the digital data base means comprises a CD rom disc and CD rom drive. However, the use of CD rom disc and CD rom drive for storing data is well known effective and efficient means for storing any data. It would have been obvious to one of ordinary skill in the art at the time of the invention to utilize CD rom disc and CD rom drive in such a system as taught through Beckwith et al. because it would permit high degree of accuracy in the storing and restoring data, random access to the data so that the requirements for cache storage are reduced.

5.4. With respect to claims 17-28, 31-35 and 38-39, both Patrick et al. and Raymer et al. articles disclose the detail about elevation data.

01431

Serial No.: 08/513,298
Art Unit: 2304

7

6. Claim 13 is rejected under 35 U.S.C. § 103 as being unpatentable over Beckwith et al and Behensky et al. as applied to claims 1-12 above, and further in view of the sales brochure from the Polhemus company.

Beckwith et al. and Behensky et al. disclose the claimed invention except for a head mounted display means worn by the pilot and an attitude determining means for determining the orientation of the pilot's head in three dimensional space. However, the sales brochure from the Polhemus company suggests the commercial availability of a position and orientation sensor which can be used on a head-mounted display. The suggestion of the Polhemus company would have motivated one of ordinary skill in the art to combine the teaching of Polhemus company with the system of Beckwith et al. in order to allow the pilot to have a complete range of motion to receive a synthesized view of the world, a complete unhindered by the aircraft structure. Thus, because of the motivation set forth above, it would have been obvious to a person of ordinary skill in the art at the time the invention was made to combine the teachings in Polhemus's brochure and Beckwith et al. patent.

7. All claims are rejected.

01432

Serial No.: 08/513,298
Art Unit: 2304

8

Remarks

8. Applicant's arguments filed on July 14, 1995 have been fully considered. Upon the amended claims which contain new issue and the further update search, new ground of rejection has been set forth above.

9. Any inquiry concerning this communication or earlier communications from the examiner should be directed to examiner Tan Nguyen, whose telephone number is (703) 305-9755. The examiner can normally be reached on Monday-Thursday from 7:30 AM-6:00 PM.

If attempts to reach the examiner by telephone are unsuccessful, the examiner's supervisor, Kevin J. Teska, can be reached on (703) 305-9704. The fax phone number for this Group is (703) 305-9564.

Any inquiry of a general nature or relating to the status of this application should be directed to the Group receptionist whose telephone number is (703) 305-3800.

TN

TAN NGUYEN
December 16, 1995

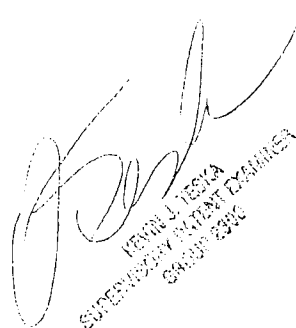
KEVIN J. TESKA
SUPERVISOR, PATENT EXAMINER
GROUP 2304

01433

TO SEPARATE, HOLD TOP AND BOTTOM EDGES, SNAP-APART AND DISCARD CARBON

FORM PTO-892 (REV. 2-92)		U.S. DEPARTMENT OF COMMERCE PATENT AND TRADEMARK OFFICE		SERIAL NO. 08/513,281	GROUP/ART UNIT 2304	ATTACHMENT TO PAPER NUMBER 15	
NOTICE OF REFERENCES CITED				APPLICANT(S) MARGOLIN			
U.S. PATENT DOCUMENTS							
•	DOCUMENT NO.	DATE	NAME	CLASS	SUB-CLASS	FILING DATE, IF APPROPRIATE	
A							
B							
C							
D							
E							
F							
G							
H							
I							
J							
K							
FOREIGN PATENT DOCUMENTS							
•	DOCUMENT NO.	DATE	COUNTRY	NAME	CLASS	SUB-CLASS	PERTINENT SHTS. PP. DWG. SPEC.
L							
M							
N							
O							
P							
Q							
OTHER REFERENCES (Including Author, Title, Date, Pertinent Pages, Etc.)							
R	Ulrich, "Tactical Mapping in Combat Aircraft", IEEE 1988, pp. 74-78						
S	Raynor et al. "Advanced Terrain Data Processor", IEEE 1994, pp. 636-639.						
T	Patrick et al., "ITars Robust Demonstration System Integration", IEEE 1988, pp. 83-87.						
U	Jacobs et al., "Fractal Image Compression Using Iterated Transforms: Applications to DTED", IEEE 1994, pp. 1122-1128						
EXAMINER Jan Nguyen		DATE 12/18/95					
* A copy of this reference is not being furnished with this office action. (See Manual of Patent Examining Procedure, section 707.05 (a).)							

0143

TACTICAL MAPPING IN COMBAT AIRCRAFT

Ulrich Buening

ESG Elektronik-System-Gesellschaft mbH
Munich, Federal Republic of Germany

ABSTRACT

During the last decade Geographical Information Systems (GIS) have been increasingly used in computer aided planning and mapping. An application of GIS in combat aircraft is tactical mapping. Tactical mapping enables the pilot to recognize spontaneous complex-air-to-ground relations such as danger zones and dead space. Tactical information (e.g. flight path, danger zones) is combined with selected geographical information (e.g. rivers, contours) and displayed on a monitor. This geographical information and some tactical data (e.g. danger zones) are derived from a GIS. The main aspect of a tactical map is to permit the pilot good visual interpretation of the displayed information.

INTRODUCTION

Improved mission effectiveness for combat aircraft requires both pilot-friendly generation of the target area scenario and an easy-to-recognize representation of the threat assessment. Modern methods of computer aided mapping provide new ways of developing tactical representation given to the pilot. A precondition for this is a computer relevant data-base holding geographical information.

In the following the evaluation of "Tactical Maps" is described. They are to be regarded as possible "display formats" in cockpits of the future.

The graphic hardware used is Bosch's CAD Station PIC 1000. The host computer is a DEC VAX 750.

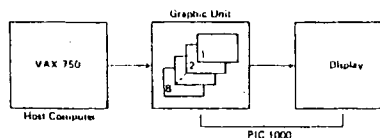

Figure 1: Hardware configuration used for developing "Tactical Maps"

GIS DEVELOPMENT

The first step is development of a GIS using the DLMS-DTED and the PACE data-base. The chosen test area is the landscape of the Black Forest (Longitude = 8-10 degree, Latitude = 48-49 degree). The raw data are provided by the "Digital Landmass System Terrain Elevation Data-Base" (DLMS-L1-DTED) of the Defense Mapping Agency (USA) and the "Project of Automated Charts Europe" (PACE) data-base of the Directorate of Military Survey (UK). The DLMS-L1-DTED data contain the heights above a specified level (NN) in a 3 x 3 seconds arc raster (3 x 6 for latitudes greater than 50 degrees). The coordinate frame is the World Geodetic System 1972 (WGS 72). The PACE data contain all the cartographic objects (features) needed for automated plotting of the "Tactical Pilotage Chart" (TPC) and the "Operational Navigation Chart" (ONC). The features are split into more than 200 categories. The coordinates are \bar{x}, \bar{y} , digitized from the sheets of the "Joint Operation Graphics" (JOG).

For the GIS the coordinate frame of the European Datum 1950 (ED 50) is chosen. The coordinates are UTM. Thus the following transformations are necessary:

- PACE

$$x(\text{UTM})=a_{01}+a_{11}\bar{x}+a_{21}\bar{y}+a_{31}\bar{x}\bar{y}$$

$$y(\text{UTM})=a_{02}+a_{12}\bar{x}+a_{22}\bar{y}+a_{32}\bar{x}\bar{y}$$

The coefficients are evaluated by four points known in \bar{x}, \bar{y} digitized and x, y UTM. They are implicitly given in the data-base for each sheet.

- DLMS-DTED

$$L, B, H(\text{ED 50})=f(d_i, p_i, m, L, B, H(\text{WGS 72}))$$

The vector of rotation d_i , the vector of translation p_i and the scale-factor m are the parameters needed for the coordinate frame transformation WGS 72 to ED 50 for the chosen area.

$$x, y(\text{UTM}), H=f(L, B), H$$

Hence an isometric height raster in the UTM System is evaluated by linear interpolation. For this the four heights in the neighbourhood of the desired raster point are taken into account.

$$H_{nm}=f(x_i, y_i, H_i) \quad i=1,2,3,4$$

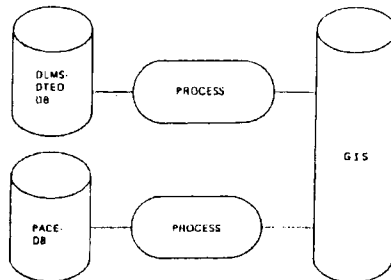

Figure 2: Development of a GIS

GEOGRAPHICAL AND TACTICAL INFORMATION

Using the GIS geographical and tactical information is derived and presented on the monitor. The scale chosen is 1 : 250,000. On the monitor this means one Pixel is equal to 127 meters. The tactical information derived from the GIS is sensor-covering:

- optical visibility (sensor = eye of the pilot)
- electrical visibility (sensor = radar, e.g. threat from a SAM-site)

Tactical information that is not derived from the GIS (e.g. home base), is stored separately in a tactical data-base.

For the calculation of the sensor-coverings the earth's curvature is taken into account by the following approximation formula:

$$\Delta H=a^2/(2\cdot R)$$

The derived partial geographical information comprises:

- elevation tints
- relief maps illuminated from several directions
- feature maps
- perspective views of the morphology

The elevation tints show the areas above a given height $H = \text{const}$. The painted shade lightens with height. The relief maps show a shading of the terrain illuminated from a given direction. The best impression is given by illuminating from the North-West.

The following features (selected from the PACE object-categories specified for the OMC and summarized) are chosen for the maps:

- waters of first order
- streets of first order
- towns with more than 10,000 inhabitants
- railways of first order

More information is not practical for the interpretation by displaying it on the graphic monitor on this scale. An assistant grid of latitude and longitude can be additionally calculated. The perspective views show a central projection of the terrain with and without threat. The 3D impression of the morphology is given by the deformation of the grid-planes. The observer's orientation can be that of the pilot or any other.

Parameters necessary for the derivation of the geographical and tactical information are the 3D position and the attitude of the observer (usually the pilot).

Figure six gives a summary of the above-mentioned tools.

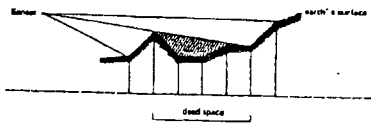

Figure 3: Sensor covering, dead space

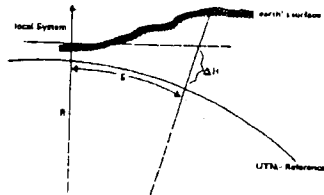

Figure 4: Earth's curvature

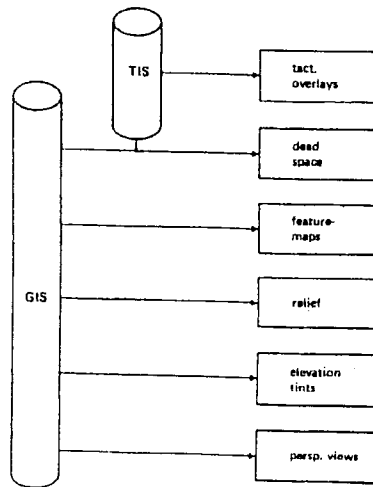

Figure 6: Tools organisation chart

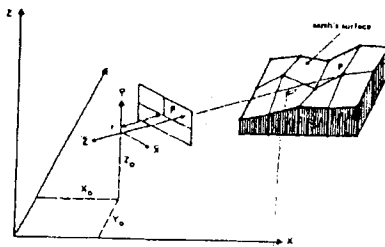

Figure 5: Central projection

EXAMPLES OF "DISPLAY FORMATS"

The derived geographical and tactical information have to be combined in a manner such that the pilot is given the best assessment in his operations. With the exception of the perspective views all the information is stored as pixel data in several layers of the frame buffer and can be selected by pushing a button. The sensor coverings and the elevation tints are transparent. The figures 7 to 11 show examples of displayed geographical information combined with tactical information for applications in combat aircraft recommended by ESQ.

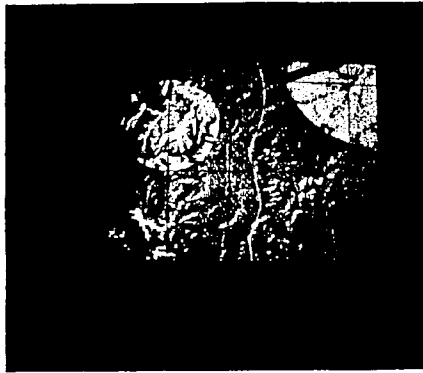

Figure 7: Relief map with elevation tints (670 m and 1000 m), waters and geographic grid. SAM covering for flight height 100 m above terrain, flight path.

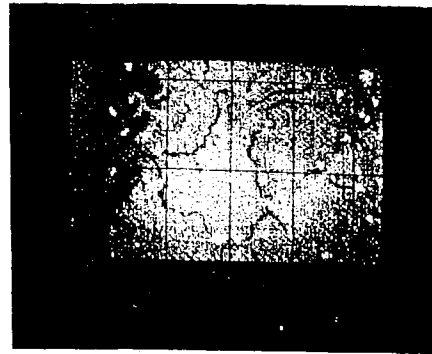

Figure 9: Map with elevation tint (670m), waters, streets, towns, railways and geographic grid.

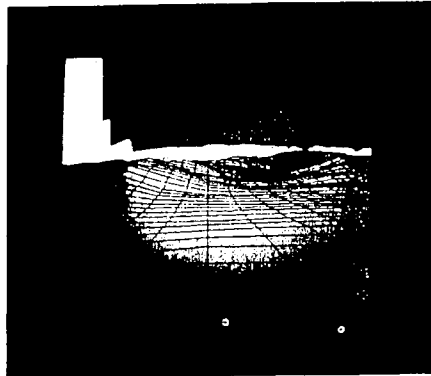

Figure 8: Perspective view of the morphology, observer located at the position $L = 8^{\circ}04'$, $B = 48^{\circ}20'$, 150 m above the terrain. Threat shown as a red cloud.

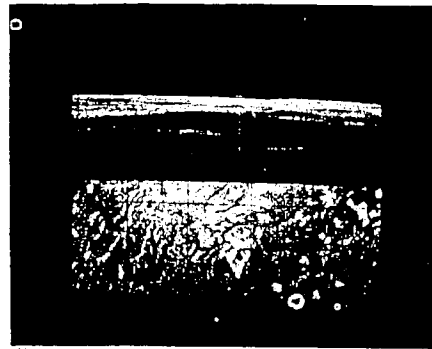

Figure 10: Bottom: geographic information like Figure 9 and relief including the area visible for the pilot flying at a height of 60 m above terrain (located at the aircraft symbol). Top: pilot's perspective view of the morphology.

J. Polyzos

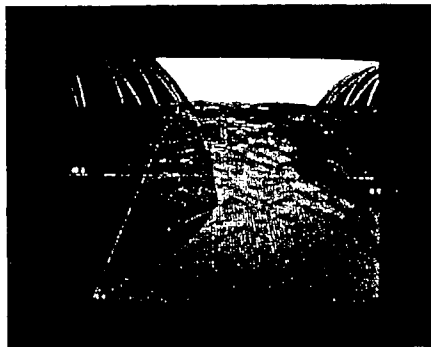

Figure 11: perspective "over"-view of the morphology from a desired area. Contour lines, rough threat environment.

CONCLUSION

The PACE data base and the DLMS-DTED are suitable for new tactical representations on displays in combat aircraft. A great advantage of the PACE data base is selectivity. For that a decluttering of the information is possible without renounce on them. If the tactical information predominates, the geographical information can be reduced successively. Thus the pilot is not inundated with information.

The selection of a scale larger than 1 : 200,000 is not to be recommended, because the cartographic generalization of the PACE data base would lead to inconsistencies.

ACKNOWLEDGEMENTS

The reported work was sponsored by the DOD (BMVg, BWS) of the FRG under contract number: E/ L31N/ G0538/ G5117. We thank for the opportunity to present the reported results.

Advanced Terrain Data Processor

Authors:
Kris Raymer
Tom Weingartner

Honeywell Defense Avionics Systems
9201 San Mateo Boulevard NE
Albuquerque, New Mexico 87113-2227

covert flight

Abstract: The Quiet Knight Technology Demonstration Program has developed an integrated avionics system that greatly enhances covert penetration capabilities of the C-130 aircraft. The system centers around an enhanced digital map called the Advanced Terrain Data Processor (ATDP). The ATDP enhances covert capability by fusing data from different sensors and sources. Aggressive terrain following is accomplished by blending Low Probability of Intercept (LPI) Radar, Ladar, and radar altimeter with Digital Terrain Elevation Data (DTED). Accurate navigation, required by terrain following, combines data from the INS, GPS, radar altimeter, and DTED. Threat avoidance is accomplished by merging on-board and over the horizon intelligence data with DTED culminating in an automatic replan. All three functions combine to provide excellent situational awareness that keeps the aircraft safe from terrain impact and enemy engagement.

System Overview

The ATDP is interconnected with multiple avionics systems to manage the aircraft mission. Figure 1 shows the avionics tested during the various phases of the program. Covert penetration is possible due to an aggressive terrain following algorithm flying set clearances of 150 to 1000 feet and by minimizing emissions from the aircraft with sophisticated sensor control techniques. Utilizing threat detection methods which allow the aircraft to detect and locate unplanned threats prior to exposure, planning routes on the ground and in-flight which minimize exposure to all threats and improving the crew's situational awareness through multiple video displays also aid in the covert capabilities.

ATDP Description

Successful mission management is possible due to the ATDP that fuses data from several external

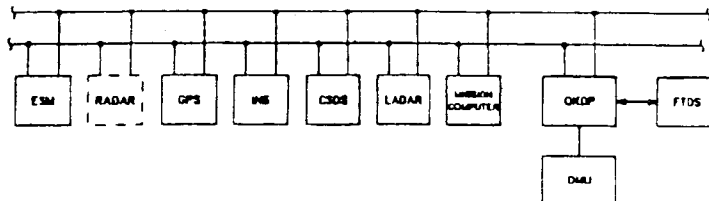

Figure 1 Quiet Knight System Diagram

01440

sources. Information is captured graphically for display to the crew and provides vehicle management commands to both the crew and other avionics systems. Figure 2 is a block diagram of the hardware which executes these management tasks.

Display Formats

Three video outputs are generated within the ATDP. Video Engine 1 provides the plan-view map in a redundant RGB format. The plan-view map displays either paper chart, DTED color banded, or still-picture information. Threat information is displayed with translucent shading indicating the detection or line of sight for threats and a single ring indicating the lethal range. Planned threats are shaded in white while unplanned threats are shaded with purple. The Intervisibility Engine calculates the display pixels which must be shaded in real-time based on the terrain following set clearance. Video Engine 2 provides two

monochrome outputs: ridgelines and energy elevation profiles (EESCAN). The ridgeline display shows six lines at 1 nmi. spacing with a field of view of +/- 30 degrees. The EESCAN display gives the pilot vertical steering information with the elevation line indicating the terrain plus commanded set clearance for the planned aircraft route. The energy line displays the maximum climb the aircraft perform. Distance is displayed logarithmically along the x-axis from 0.1 nmi. to 20 nmi. The y-axis represents the flight path angle from +15 to -20 degrees. The elevation line includes any combination of stored DTED and obstacle information, terrain from the RADAR, and terrain and obstacle data from the LADAR.

Steering Commands

The ATDP provides passive pitch and roll commands to the pilot on the ADI. The roll is based on the preplanned route and

Ated = paper

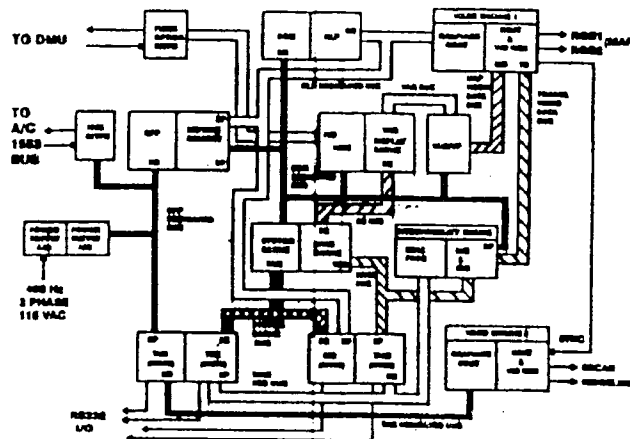

Figure 2 ATDP Block Diagram

aircraft characteristics and attempts to minimize cross-track errors while the pitch commands are generated by an ADLAT algorithm tailored to a C-130 vehicle. The pitch commands attempt to maintain the commanded set clearance at all times.

Elevation Profile

The elevation profile input to ADLAT for vertical steering and the EESCAN display format is fused from a variety of sources. The baseline profile is based on stored DTED data provided by the Defense Mapping Agency. Blended with this data is information from forward looking sensors. RADAR and LADAR data can be blended into the DTED profile. The forward looking sensors are commanded by the ATDP to scan a limited region ahead of the aircraft. This blending mechanism provides two important enhancements to the vehicle management. First, by blending sensor data with DTED, the sensors need only scan 1.8 nmi. ahead of the aircraft and can reduce their emitting power. The scan region is further limited to the planned route which significantly reduces the detection probability. Secondly, the forward looking sensor improves flight safety concerns by correcting or verifying the DTED data.

Threat Avoidance

The ability to respond quickly and efficiently to in-flight threats is critical to maintaining covert status. The on-board Electronic Support Measures (ESM) can detect threats prior to entering line-of-sight. ESM detected threats are sent to the Constant Source Data System (CSDS) for correlation to the

present threat database. CSDS also receives broadcast threat information and performs the same correlation function. The CSDS will update known threats or issue new threats to the ATDP as necessary. When the ATDP receives a new threat, it updates its database, calculates the line-of-sight for the threat that will be displayed on the planview map, and determines if evasive action is required. The ATDP is constantly searching the planned route for intersections with unplanned threats. Should an intersection be detected within 25 nmi. of present position, an in-flight mission replan can be invoked. The in-flight replan is identical to the ground based route planner and is a modified A-Star algorithm. The route generated will be the lowest cost route based on exposure to a threat's detection and lethal regions, path length, path vertical changes, and a measure of each point on the path's vulnerability.

Navigation

An highly accurate navigation solution is key to safely executing the previous functions. The ATDP includes an 18 state Kalman filter that blends INS, GPS, and terrain referenced measurements to correct for INS errors. The incorporation of both GPS and terrain referenced measurements gives this navigation filter the unique ability to correct for errors in the DTED database, further improving safety of flight.

Summary

The ATDP is a vehicle management system. It controls the scan patterns and power of the forward looking sensors. It also issues steering commands along a planned route which minimize exposure to threats and has been determined to be safe for low level terrain following. The aircraft survivability is dramatically improved since the ingress, mission task, and egress have been made safer due to the enhanced situational awareness and improved terrain following. This system increases the likelihood that both the aircraft and its crew will return from each and every mission, and that is a feature whose value is immeasurable.

ITARS ROBUST DEMONSTRATION
SYSTEM INTEGRATION

Mr. Ray Patrick
Mr. G. Mel Barney

Merit Technology Incorporated
Plano, Texas

Abstract

With the availability of Digital Terrain Elevation Data (DTED), mass storage systems such as the ITARS, have been developed for use in avionics applications requiring real-time access to large amounts of DTED data. Merit Technology has developed an avionics simulation that interfaces directly to DTED mass storage systems.

Under a subcontract with Hughes Aircraft Corporation, Merit Technology has developed this simulation system with a direct interface to the ITARS digital map. The system, known as the Robust Demonstration System (RDS) effectively demonstrates how ITARS digital terrain data could be used by aircraft of the future involving Terrain Following, Terrain Avoidance and SITAN avionics algorithms. This paper describes the ITARS/RDS system architecture, integration results, and areas of possible improvement.

INTRODUCTION

With the advent of Terrain Following radar, a new breed of navigation subsystems has emerged that requires accurate and detailed knowledge about surrounding terrain. Early TF systems relied entirely on elevation data measured by return signals from an onboard radar. Such systems allowed aircraft to fly safely at very low altitudes with little or no pilot intervention. The drawback of this method, however, was that a sizable radar signature was produced from the radiation emitted from the TF radar. Within the last ten years, large scale digital terrain elevation data (DTED) storage systems have become a reality and have the potential to greatly improve TF systems, as well as make feasible other avionics algorithms such as terrain avoidance, terrain navigation, and threat avoidance.

The ITARS is an airborne digital map system that stores, manages and displays large quantities of cartographic and mission data including (but not limited to) terrain elevation data and cultural

feature data. This data is maintained by the system and made available to various avionics subsystems.

The ITARS Robust Demonstration System (RDS) provides a realistic set of avionics subsystems that exercise the ITARS's ability to manage and distribute terrain elevation, and cultural feature data. The RDS provides Navigation, Terrain Following, and Terrain Avoidance/Threat Avoidance subsystems along with an aircraft flight model, threat assessment model, RDS to ITARS communication, joystick flight controls, and a user-friendly scenario generation interface. The system is configured with commercially available components including two MicroVAXs and an IBM PC/AT.

ITARS/RDS System Overview

Functional description of ITARS

The ITARS is designed to interact with three primary avionic subsystems which require timely access to digital terrain and feature data. These subsystems are known as "users" and consist of a Navigation user, Terrain Following user, and Terrain Avoidance/Threat Avoidance user. Communication between the ITARS and these user subsystems is accomplished with messages sent over two communication paths. ITARS control, status and fault isolation messages travel along a MIL-STD 1551B data bus. Larger messages (typically output data received from the ITARS) travel along a High Speed Data Bus (HSDB). As currently implemented, the HSDB is an Ethernet data link.

As shown in Figure 1, terrain data is sent to these users in the form of Terrain Output Messages which contain elevation data points measured in meters above sea-level and are organized as North Up blocks of 16 by 16 points. For the Navigation and TF user, each block is 48 arcseconds on a side (resulting in a point resolution of 3 arcseconds). For the TA/ThA user, each block is 240 arcseconds on a side (resulting in a point resolution of 15 arcseconds). Each user receives an

Area Load of data which consists of a series of blocks organized in a two dimensional manner. This area load contains elevation data for an area surrounding the current aircraft position. The size of the area load, as well as the rate at which it is sent to each user is specified in the ITARS User Request Message. Feature data is sent to each user in the form of Feature Output Messages. The area for which features are supplied, is the area covered by the user's terrain area load.

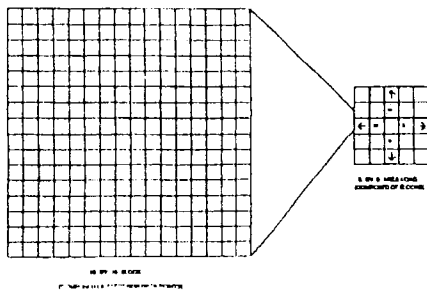

Figure 1. ITARS Terrain Output Data

Positional information is sent to the ITARS in the form of a Navigation/Aircraft State Vector Message. This message contains the position, as well as the current heading, pitch, and ground speed of the aircraft.

Threat features and waypoint information may be introduced into the ITARS with the ITARS Point Feature/Mission Data Message. This message, in conjunction with the Aircraft State Vector message, allows the pilot to designate a point on the ITARS display. Table 1 summarizes the major ITARS messages used by RDS.

Message	Type	Description
Aircraft State Vector	1553B	Provides positional information to the ITARS
User Request Message	1553B	Specifies which users are active and the size and rate of area loads
Point/Feature Message	1553B	Provide threat and waypoint information to ITARS (at any time)

Terrain Output Message HSDB	Provides terrain data to the RDS
Feature Output Message HSDB	Provides feature data to the RDS

Table 1. RDS/ITARS Messages

In addition to managing data, the ITARS can simultaneously generate two situation displays. These displays are full color raster views of data stored within the system, with a great deal of control possible over each image rendered. Typical formats for these displays include a perspective (out the window) view and a plan view with contour and shaded relief map options.

Functional description of the RDS

The RDS software simulates the user subsystems communicating with the ITARS and provides a scenario generation capability to define waypoints, threats, and means of flight control (autopilot or joystick). In addition, the user may specify the size and rate of area loads to be received from the ITARS. The system also includes a Route Planning algorithm which is executed if Terrain Avoidance/Threat Avoidance is enabled.

Once the scenario is constructed, waypoint and threat information is sent to the ITARS with an ITARS Point/Feature Mission Data Message. Selected user algorithms, as well as the size and desired update rates of designated area loads is sent to the ITARS with the ITARS User Request Message. An initial aircraft position (corresponding to the first defined waypoint) is sent to the ITARS with an ITARS Aircraft State Vector. After receiving these messages, the ITARS starts data transmission to the enabled user subsystems. This data is continually sent by the ITARS and is received by each user subsystem which maintains a double-buffer of received area loads. The TA/ThA area is handled differently in that it is sent on demand (i.e. when the User Request Message is sent to the ITARS) and contains data for the entire ITARS gaming area. The RDS uses this data to perform threat masking calculations as well as Terrain Avoidance/Threat Avoidance computations. When the flight simulation is started, the RDS flight model simulates the movement of an A-7 aircraft through the set of designated waypoints. As each flight position is computed, an aircraft state vector message is constructed and sent to the ITARS. To maintain an acceptable update rate, the RDS interpolates between

flight model positions resulting in several aircraft state vectors for each flight model position derived.

The flight simulation is monitored with the RDS console. An aircraft symbol is displayed on the gaming region map and moves from waypoint to waypoint. The display also maintains a separate window for monitoring ITARS to RDS message traffic.

Internal RDS organization

As shown in Figure 2, the user algorithms, the flight model, and the ITARS communication software are organized into separate processes coexist on two microVAXs. Each process is a self-contained program that is controlled by the main process (which also contains the flight model and route planner). Each process is highly independent of the others, with communication between each process being accomplished using Digital Equipment's DECNET software. The software is partitioned across both microVAXs according to memory, throughput and hardware interface requirements.

Figure 3 illustrates the hardware configuration of the RDS system and its relationship with the ITARS. The user interacts with the system using the IBM PC/AT keyboard and mouse. The PC monitor is a high resolution color display (1024 by 800 pixels) driven by a high resolution graphics controller (VMI-1024). During the simulation flight, the user may maneuver the aircraft using the joystick connected to the MicroVAX. In addition to the microVAX, a separate IBM PC/AT called

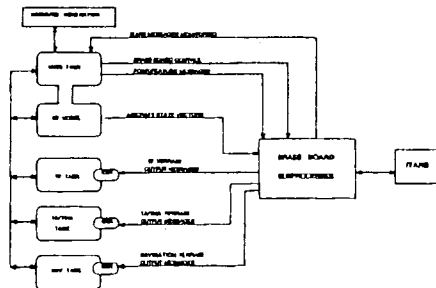

Figure 2. RDS Internal Organization

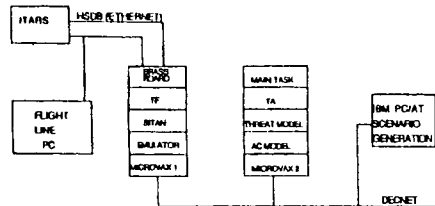

Figure 3. RDS Hardware Configuration

the flightline PC is also connected to the 1553. This PC sends ITARS Mode Control Messages and Point Feature Messages to the ITARS. Mode control messages control the ITARS mode of operation, allowing the user to alter the view on either of the ITARS displays.

All ITARS communication is handled by one program called the Brass Board process. This program provides both a 1553B and Ethernet communication link with the ITARS. Messages sent to the ITARS from the RDS are first routed to the Brass Board process via DECNET and mailbox communication links (a form of interprocess communication). The Brass Board process examines the message header to determine which 1553 subaddress the message should be sent to. The message is then forwarded to the ITARS. The Brass Board subprocess acts as the Bus Master for the entire 1553 data bus, coordinating all message traffic including mode message and point/feature message traffic originating from the Hughes flightline PC.

The Brass Board process asynchronously forwards 1553B messages to the ITARS while managing incoming data from the Ethernet link. When a message is received from the ethernet link, the system performs a validity check on the message and then parses the message header to determine which user subsystem should receive the message. The message is then forwarded to the correct user via DECNET or a mailbox communication link. Each time an area load of data is received by the Brass Board process, a message is sent to the RDS main task detailing the size and type of area load received. The main task forwards this message to the PC/AT software for display on the screen. This mechanism allows the operator to monitor incoming data from the ITARS.

Each use subsystem interfaces with the Brass Board process with a set of routines known as the ITARS Data Interface Routines (IDIR) (see Figure 2). These routines

[REDACTED]

From: Galus, Helen M. (LARC-B2)
Sent: Thursday, July 17, 2008 11:55 AM
To: Rotella, Robert F. (HQ-MA000)
Cc: Blackburn, Linda B. (LARC-B2); Bayer, Kathy (HQ-MC000)
Subject: File wrapper for 5,904,724
Attachments: PAT-00016 Margolin - 5,904,724 - A (L0062064).PDF; PAT-00016 Margolin - 5,904,724 - B (L0062065).PDF; PAT-00016 Margolin - 5,904,724 - C (L0062079).PDF; PAT-00016 Margolin - 5,904,724 - D (L0062080).PDF; PAT-00016 Margolin - 5,904,724 - E (L0062081).PDF; PAT-00016 Margolin - 5,904,724 - E1 (L0062083).PDF; PAT-00016 Margolin - 5,904,724 - F (L0062084).PDF; PAT-00016 Margolin - 5,904,724 - G (L0062085).PDF; PAT-00016 Margolin - 5,904,724 - G2 (L0062086).PDF

Bob,

I just realized, looking at the document names, that we actually have TWO file wrappers in our possession, one for 5,566,073 as well as the file wrapper for Margolin's second patent No. 5,904,724.

Thus, my last email incorrectly stated it was only the first half of the file wrapper, when in fact it was the complete file wrapper for 5,566,073; attached hereto is the complete file wrapper for Patent No. 5,904,724.

Sorry for the confusion. (I will resend my first email listing the documents we have with a note to include the second file wrapper on the list.)

Thanks,
Helen

Helen M. Galus
Patent Attorney
Office of Chief Counsel
NASA Langley Research Center
[REDACTED]

[REDACTED]

b(6)

e-mail: Helen.M.Galus@nasa.gov

This email message is for the sole use of the intended recipient(s) and may contain confidential and/or privileged information. NOTICE: Any review, use, disclosure or distribution by persons or entities other than the intended recipient(s) is prohibited. If you are not the intended recipient, please contact the sender by reply and destroy all copies of the original message. Thank you.

01447

United States Patent File History

Tab Listings

- A. References (if applicable)
 - A1-U.S. References
 - A2-Foreign References
- B. Jacket (face of file, contents flap, index of claims, PTO 270, searched)
- C. Printed Patent
- D. Specification (serial no. sheet, abstract, specification, claims)
- E. Oath
 - E1-Small Entity Status (if applicable)
- F. Drawing Figures (if applicable)
- G. PTO/Applicant Correspondence
- H. Original Patent Application (in cases of FWC)

Supplied by:
REEDFAX Document Delivery System

117 Gibraltar Road, Horsham, PA 19044-0962

Customer Service: 1 800-422-1337 or 215-441-4768

Fax: 1 800-421-5585 or 215-441-5463

01449

REEDFAX®

THE PATENT CONNECTION

 A member of the Reed Elsevier plc group

REEDFAX Document Delivery System
275 Gibraltar Road • Horsham, PA 19044 • USA
Voice 1.800.422.1337 or 1.215.441.4768
FAX 1.800.421.5585 or 1.215.441.5463

Our services include:

- U.S. Patents from #1 to current week of issue
- Design and Plant Patents
- Reissue Patents and Re-exam Certificates
- U.S., EP and Canadian File Histories/Wrappers
- Non-US Patents including European and World
- Trademarks and Trademark File Histories
- An Automated System that operates in 15 min. 24 hrs./day, 365 days/yr.
- Dedicated Customer Service Staff

TO REPORT TROUBLE WITH THIS TRANSMISSION or for REEDFAX CUSTOMER SERVICE, CALL 1.800.422.1337. ONCE CONNECTED, IMMEDIATELY PRESS "0" (ZERO) FOR OPERATOR.

TO: Kelly Wright

Company Number: 3814
Account Number: 1306584
Client Reference: for BARRY GIBBENS-INTERFERENCE

Date: 05/16/2003

Patent Number: 5904724
File History

Comments: Overnight Courier

Address: Kelly Wright
NASA Langley Research Center
Office of Patent Counsel

Telephone Number: 

b(6)

01449

05/1

787731

120	Subclass
701	Class
ISSUE CLASSIFICATION	



5904724

UTILITY SERIAL NUMBER 587731	PATENT DATE MAY 18 1999	PATENT NUMBER	5904724
SERIAL NUMBER 127587,701	FILING DATE 01/15/99	CLASS 701	EXAMINER N001117
	SUBCLASS 437	GROUP ART UNIT 3614	

APPLICANTS

JED MARGOLIN, SAN JOSE, CA. 3661

CONTINUING DATA***

VERIFIED
TV

FOREIGN/PCT APPLICATIONS***

VERIFIED
TV

**** SMALL ENTITY ****

Foreign priority claimed 35 USC 119 conditions met	<input type="checkbox"/> yes <input checked="" type="checkbox"/> no	AS FILED	STATE OR COUNTRY CA	SHEETS DRWGS. 7	TOTAL CLAIMS 49	INDEP. CLAIMS 5	FILING FEE RECEIVED \$772.00	ATTORNEY'S DOCKET NO. 802855.P004
Verified and Acknowledged	Examiner's initials TV	→						

ADDRESS

BLARELY SOBLOFF TAYLOR AND ZAFMAN
12400 WILSHIRE BOULEVARD
7TH FLOOR
LOS ANGELES CA 90025

TITLE

METHOD AND APPARATUS FOR REMOTELY PILOTING AN AIRCRAFT

U.S. DEPT. OF COMM./ PAT. & TM—PTO-436L (Rev.12-94)

PARTS OF APPLICATION FILED SEPARATELY		Applications Examiner	
NOTICE OF ALLOWANCE MAILED		CLAIMS ALLOWED	
AUG 24 1998		Total Claims 20	Print Claim 1
ISSUE FEE \$55		DRAWING	
Amount Due 660.00	Date Paid 12-3-98	Sheets Drwg. 7	Print Fig.S. 3 and 4
Label Area		ISSUE BATCH NUMBER I16	
Assistant Examiner		Primary Examiner	
TAN Q. NGUYEN PATENT EXAMINER APT UNIT 3614		PREPARED FOR ISSUE	
WARNING: The information disclosed herein may be restricted. Unauthorized disclosure may be prohibited by the United States Code Title 35, Sections 122, 181 and 368. Possession outside the U.S. Patent & Trademark Office is restricted to authorized employees and contractors only.			

Form PTO-436A (Rev. 8/92)

ISSUE FEE IN FULL

(FACE)

01450

08/587731

PATENT APPLICATION

APPROVED FOR LICENSE



08587731

INITIALS _____

Date Entered or Counted

CONTENTS

Date Received or Mailed

Date Entered or Counted	Description	Date Received or Mailed
	1. Application _____ papers.	
	2. Information Disclosure Statement	1-17-96
7-18	3. res 3 month	7-23-97
	4. INTERVIEW SUMMARY	9-12-97
10-5-97	5. Amold A	9-11-97
10-14	6. Letter	10/14/97
10-23	7. letter response	10-21-97
11-21	8. res 3 mos with	11-28-97
	9. IDS	2 March 1998 (Cym)
	10. Amold B	2 March 1998 / 2/97
5/4	11. Amold B	MAY - 4 1998
	12. Res for Reexam	9/3/98
7/24	13. Amold B & A	JUL 24 1998
8-13-98	14. Amold B (A) Amold B	7, 1998
	15. Amold B (A) Amold B	8-21-98
	16. PTO 37	AUG 24 1998 8/24
9/1	17. Suppl 37	12-1-98
	18. PTO GRANTING 18 1999	
	19.	
	20.	
	21.	
	22.	
	23.	
	24.	
	25.	
	26.	
	27.	
	28.	
	29.	
	30.	
	31.	
	32.	

Staple Issue Slip Here

POSITION	ID NO.	DATE
CLASSIFIER	65	2-26-96
EXAMINER	40254	2-26-96
TYPIST	BA	3-11-96
VERIFIER	314	3-12-96
CORPS CORR.		
SPEC. HAND		
FILE MAINT.		
DRAFTING		

INDEX OF CLAIMS

Claim	Date	
	Final	Original
1	1	27 18 97
2	2	11 20 97
3	3	05 23 97
4	4	07 23 97
5	5	08 23 97
6	6	08 23 97
7	7	
8	8	
9	9	
10	10	
11	11	
12	12	
13	13	
14	14	
15	15	
16	16	
17	17	
18	18	
19	19	
20	20	
21	21	
22	22	
23	23	
24	24	
25	25	
26	26	
27	27	
28	28	
29	29	
30	30	
31	31	
32	32	
33	33	
34	34	
35	35	
36	36	
37	37	
38	38	
39	39	
40	40	
41	41	
42	42	
43	43	
44	44	
45	45	
46	46	
47	47	
48	48	
49	49	
50	50	

Claim	Date	
	Final	Original
51	51	06 25 98
52	52	07 23 98
53	53	08 20 98
54	54	
55	55	
56	56	
57	57	
58	58	
59	59	
60	60	
61	61	
62	62	
63	63	
64	64	
65	65	
66	66	
67	67	
68	68	
69	69	
70	70	
71	71	
72	72	
73	73	
74	74	
75	75	
76	76	
77	77	
78	78	
79	79	
80	80	
81	81	
82	82	
83	83	
84	84	
85	85	
86	86	
87	87	
88	88	
89	89	
90	90	
91	91	
92	92	
93	93	
94	94	
95	95	
96	96	
97	97	
98	98	
99	99	
100	100	

- SYMBOLS
- ✓ Rejected
 - = Allowed
 - (through numeral) Canceled
 - + Restricted
 - N Non-elected
 - I Interference
 - A Appeal
 - O Objected

(LEFT INSIDE)

01452

STAPLE AREA

U.S. GOVERNMENT PRINTING OFFICE: 1997-424-353

PATENT NUMBER	ORIGINAL CLASSIFICATION			
	CLASS	SUBCLASS		
	701	120		
APPLICATION SERIAL NUMBER	CROSS REFERENCE(S)			
08/587,731	CLASS	SUBCLASS (ONE SUBCLASS PER BLOCK)		
APPLICANT'S NAME (PLEASE PRINT)	701	2	24	
MARGOLIN	244	189	190	
IF REISSUE, ORIGINAL PATENT NUMBER	348	114		
INTERNATIONAL CLASSIFICATION				
G 0 6 F	165 / 00			
H 0 4 N	7 / 18			
	GROUP ART UNIT	ASSISTANT EXAMINER (PLEASE STAMP OR PRINT FULL NAME)		
	3614	TAN Q. NGUYEN		
		PRIMARY EXAMINER (PLEASE STAMP OR PRINT FULL NAME)		

PTO 270
(REV. 5-91)

ISSUE CLASSIFICATION SLIP

U.S. DEPARTMENT OF COMMERCE
PATENT AND TRADEMARK OFFICE

01453

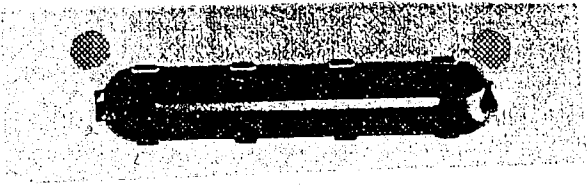

SEARCHED			
Class	Sub.	Date	Exmr.
364	423.099 424.012 424.013 424.021 424.022 449.2 449.7 460.43 424.028	07/7/97	TN
340	825.69 825.72 967 989 991 992 993		
244	189 190 181 17813 311 315	07/14/97	TN
update as above	Search	11/20/97	TN
348	42 51 113 114 117 123 143		
382 395	154 118,119 125		
update search as above		04/30/98	TN

439
 Noted: Class 364/423 099, 424.012, 424.028
 424.013, 424.021, 424.022, 449.2, 449.7, 460
 have been changed to 701/2, 3, 4, 11, 12, 24,
 202, 213, 300, 120.

INTERFERENCE SEARCHED			
Class	Sub.	Date	Exmr.
701	2 24 180 213	08/20/98	TN
244	189 190		
348	114		

SEARCH NOTES		
	Date	Exmr.
Major search	06/25/97	TN
APS search	07/12/97	TN
APS search	07/14/97	TN
STN search	07/14/97	TN
IBEE search	07/15/97	TN
APS search	11/20/97	TN
APS search	08/20/98	TN

FILE "USPAT" ENTERED AT 13:11:22 ON 12 JUL 1997

SET PAGE SYMBOL

001 S REPORT (SA) (CRAFT OR RV OR REMOT) PILOT (SA) (PILOT OR AERIAL)

002 S VIDEO (SA) IMAGE OR CAMERA

003 S FLIGHT AND POSITION OR LOCAT) AND ORIENTAT) OR ORIENTAT)

004 S 13 AND L4

005 S 13 AND L4

FILE "USPAT" ENTERED AT 09:40:00 ON 14 JUL 1997

001 S UNMANNED AERIAL OR UAV OR REMOTE PILOTED VEHICLE OR R

002 S VIDEO OR IMAGE OR CAMERA OR PROJECT) (SA) IMAGE

003 S 13 AND L4

004 S 13 AND L4

005 S 13 AND L4

006 S 13 AND L4

007 S 13 AND L4

008 S 13 AND L4

009 S 13 AND L4

010 S 13 AND L4

011 S 13 AND L4

012 S 13 AND L4

013 S 13 AND L4

FILE "USPAT" ENTERED AT 15:30:43 ON 14 JUL 1997

001 S 13 AND L4

002 S 13 AND L4

003 S 13 AND L4

004 S 13 AND L4

005 S 13 AND L4

FILE "USPAT" ENTERED AT 09:44:11 ON 20 NOV 1997

001 S REPORT (SA) (CRAFT OR RV OR REMOT) PILOT (SA) (PILOT OR AERIAL)

002 S VIDEO (SA) IMAGE OR CAMERA OR PROJECT) (SA) IMAGE

003 S FLIGHT AND POSITION OR LOCAT) AND ORIENTAT) OR ORIENTAT)

004 S 13 AND L4

005 S 13 AND L4

006 S 13 AND L4

007 S 13 AND L4

008 S 13 AND L4

009 S 13 AND L4

010 S 13 AND L4

011 S 13 AND L4

012 S 13 AND L4

013 S 13 AND L4

FILE "USPAT" ENTERED AT 15:27:52 ON 30 APR 1998

001 S REPORT (SA) (CRAFT OR RV OR REMOT) (SA) PILOT (SA) VER

002 S VIDEO (SA) IMAGE OR CAMERA OR PROJECT) (SA) IMAGE

003 S FLIGHT AND POSITION OR LOCAT) AND ORIENTAT) OR ORIENTAT)

004 S 13 AND L4

005 S 13 AND L4

006 S 13 AND L4

007 S 13 AND L4

008 S 13 AND L4

009 S 13 AND L4

010 S 13 AND L4

011 S 13 AND L4

012 S 13 AND L4

013 S 13 AND L4

01454



US005 24A

United States Patent [19] Margolin

[11] Patent Number: **5,904,724**
[45] Date of Patent: **May 18, 1999**

[54] METHOD AND APPARATUS FOR REMOTELY PILOTING AN AIRCRAFT

[76] Inventor: **Jed Margolin**, 3570 Pleasant Echo, San Jose, Calif. 95148

- [21] Appl. No.: **08/587,731**
- [22] Filed: **Jan. 19, 1996**
- [51] Int. Cl.⁶ **G06F 165/00; H04N 7/18**
- [52] U.S. Cl. **701/120; 701/2; 701/24; 244/189; 244/190; 348/114**
- [58] Field of Search 364/423.099, 424.012, 364/424.013, 424.021, 424.022, 449.2, 449.7, 460, 439, 424.028; 340/825.69, 825.72, 967, 989, 991, 992, 993; 244/189, 190, 181, 17.13, 3.11, 3.15; 348/42, 51, 113, 114, 117, 123, 143; 382/154; 395/118, 119, 125

[56] References Cited

U.S. PATENT DOCUMENTS

3,742,495	6/1973	Diamantides	342/64
3,795,909	3/1974	Vehrs, Jr.	343/7
4,218,702	8/1980	Brocard et al.	348/144
4,405,943	9/1983	Kanaly	358/133
4,467,429	8/1984	Kendig	343/433
4,660,157	4/1987	Beckwith et al.	345/421
4,739,327	4/1988	Konig et al.	342/26
4,760,396	7/1988	Barney et al.	342/65
4,835,532	5/1989	Fant	382/284
4,855,822	8/1989	Naredra et al.	364/423.099
4,964,598	10/1990	Berejik et al.	244/190
5,015,187	5/1991	Lord	364/462
5,072,396	12/1991	Fitzpatrick et al.	364/450
5,086,396	2/1992	Warszewski, Jr.	364/454
5,155,683	10/1992	Rahim	364/424.029
5,179,638	1/1993	Dawson et al.	395/125
5,240,207	8/1993	Eiband et al.	364/423.099
5,257,347	10/1993	Busbridge et al.	395/129
5,266,799	11/1993	Steinitz et al.	324/330
5,272,639	12/1993	McGuffin	364/449
5,335,181	8/1994	McGuffin	364/443
5,381,338	1/1995	Wysocki et al.	348/116

5,406,286	4/1995	Tran et al.	342/13
5,446,666	8/1995	Bauer	364/434
5,552,983	9/1996	Thornberg et al.	364/424.027
5,581,250	12/1996	Khviliviky	340/961

OTHER PUBLICATIONS

Lyons, J.W., "Some Navigational Concepts for Remotely Piloted Vehicles", AGARD Conference Proceed, n 176, Med. Accur. Low Cost Navig. at Avion, Panel Tec. Meeting, 5-1-5-15, Sep. 1975.

"US GeoData Digital Line Graphs", U.S. Dept. of the Interior, U.S. Geol. Surv. Earth Sci. Info Ctr. (Factsheet) Jun. 1993.

"US GeoData Digital Elevation Models", U.S. Dept. of the Interior, U.S. Geol. Surv. Earth Sci. Info Ctr. (Factsheet) Jun. 1993.

Shifrin, Carol A., "Gripen Likely to Fly Again Soon," *Aviation Week & Space Technology*, Aug. 23, 1993, pp. 72-73.

Primary Examiner—Tan Q. Nguyen
Attorney, Agent, or Firm—Blakely, Sokoloff, Taylor and Zafman LLP

[57] ABSTRACT

A method and apparatus that allows a remote aircraft to be controlled by a remotely located pilot who is presented with a synthesized three-dimensional projected view representing the environment around the remote aircraft. According to one aspect of the invention, a remote aircraft transmits its three-dimensional position and orientation to a remote pilot station. The remote pilot station applies this information to a digital database containing a three dimensional description of the environment around the remote aircraft to present the remote pilot with a three dimensional projected view of this environment. The remote pilot reacts to this view and interacts with the pilot controls, whose signals are transmitted back to the remote aircraft. In addition, the system compensates for the communications delay between the remote aircraft and the remote pilot station by controlling the sensitivity of the pilot controls.

20 Claims, 7 Drawing Sheets

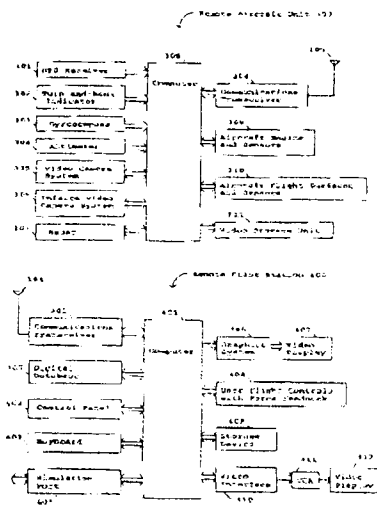

01455

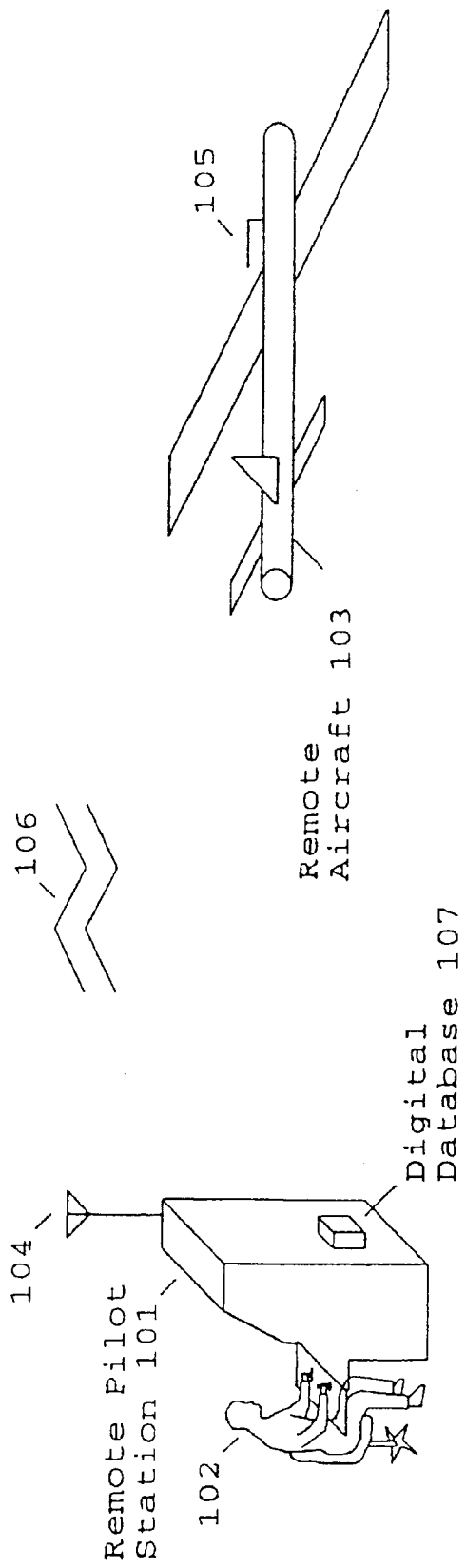

Fig. 1

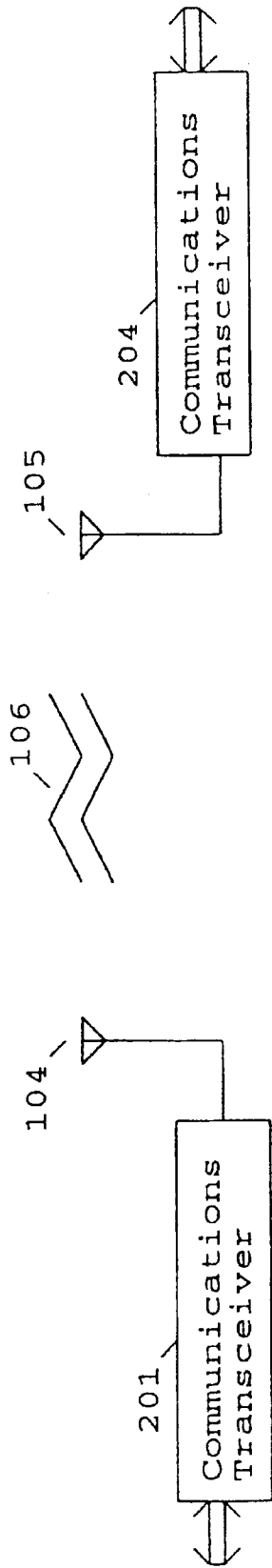

Fig. 2

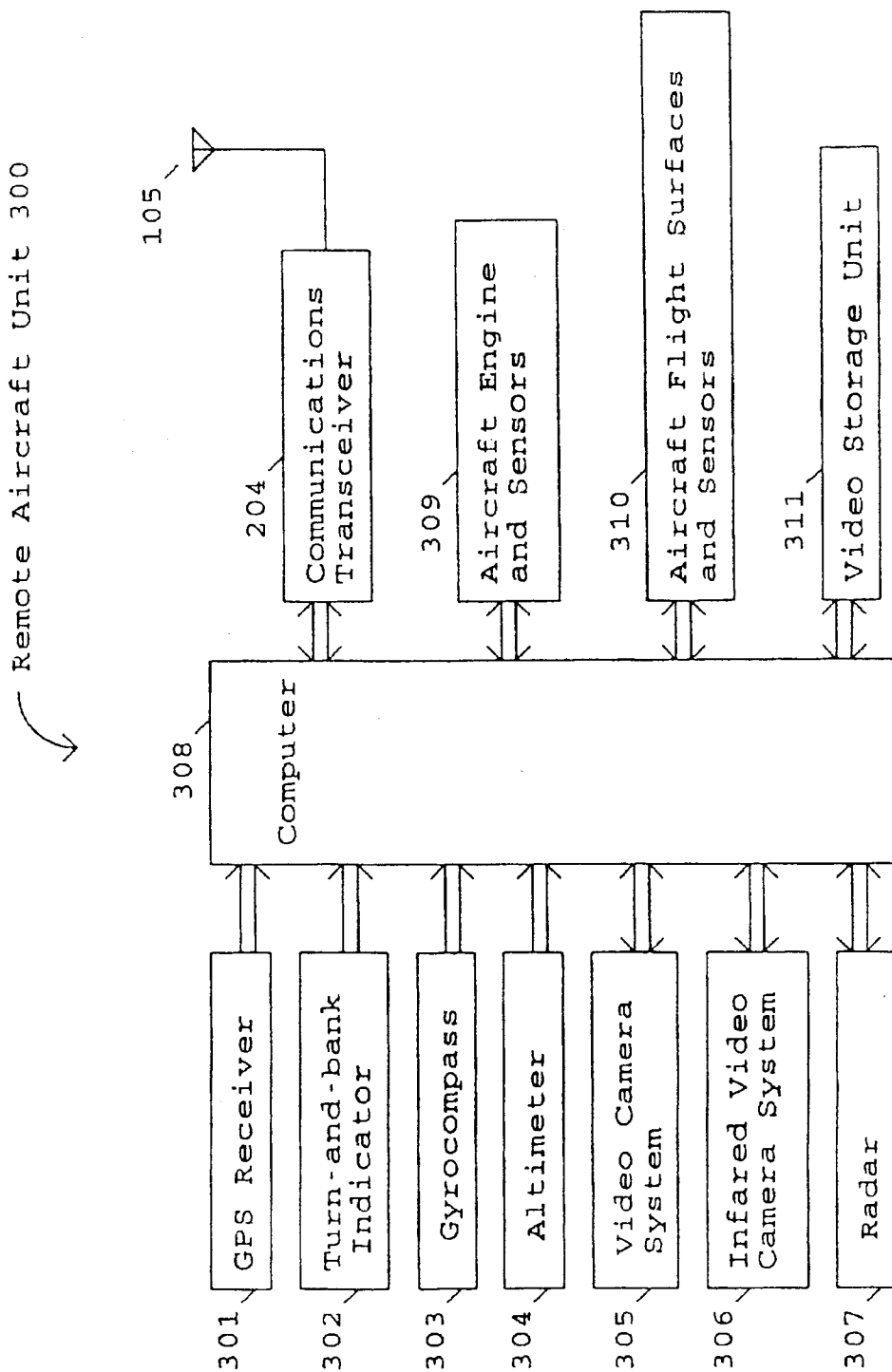
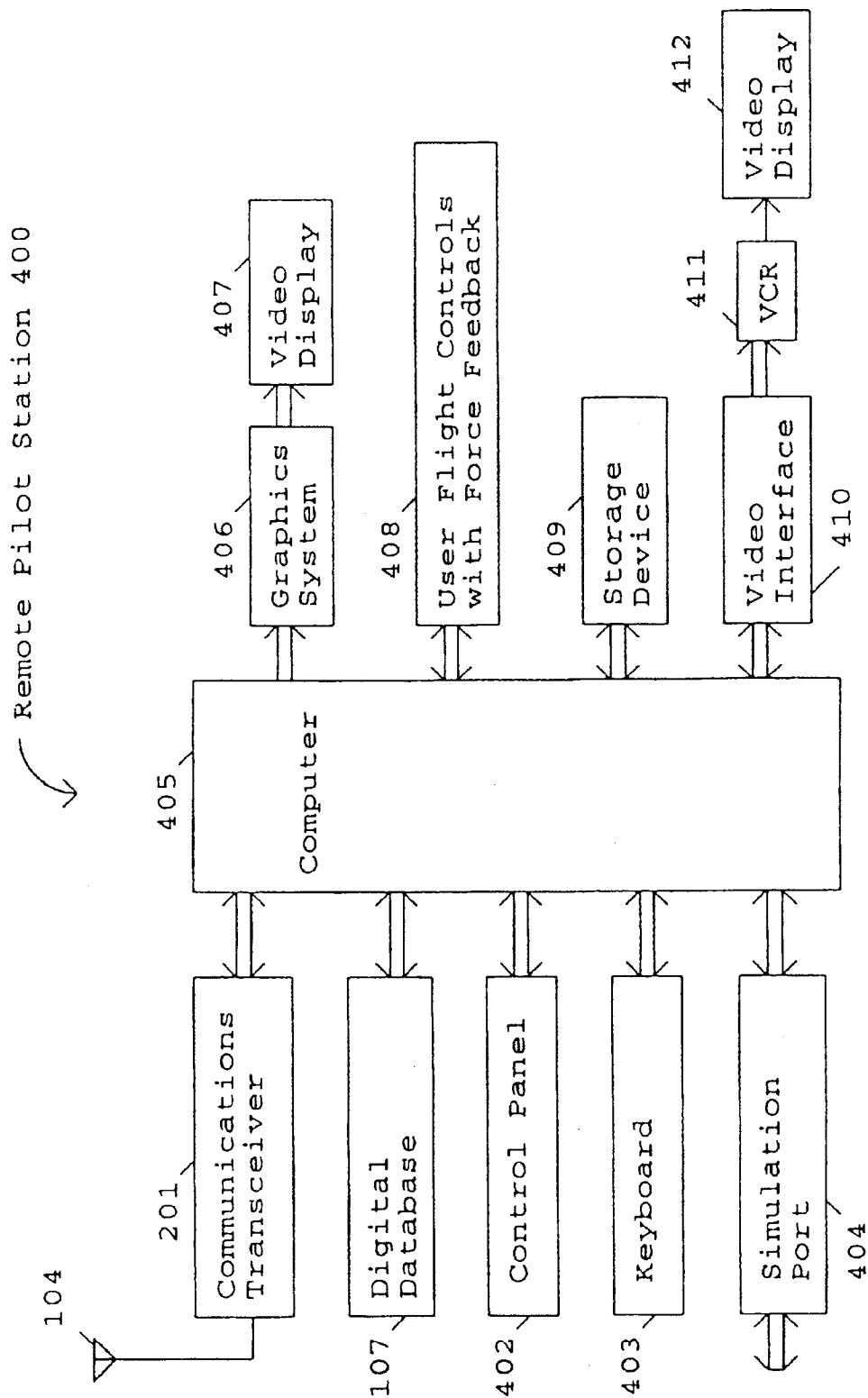

Fig. 3



Remote Pilot Station 400

Fig. 4

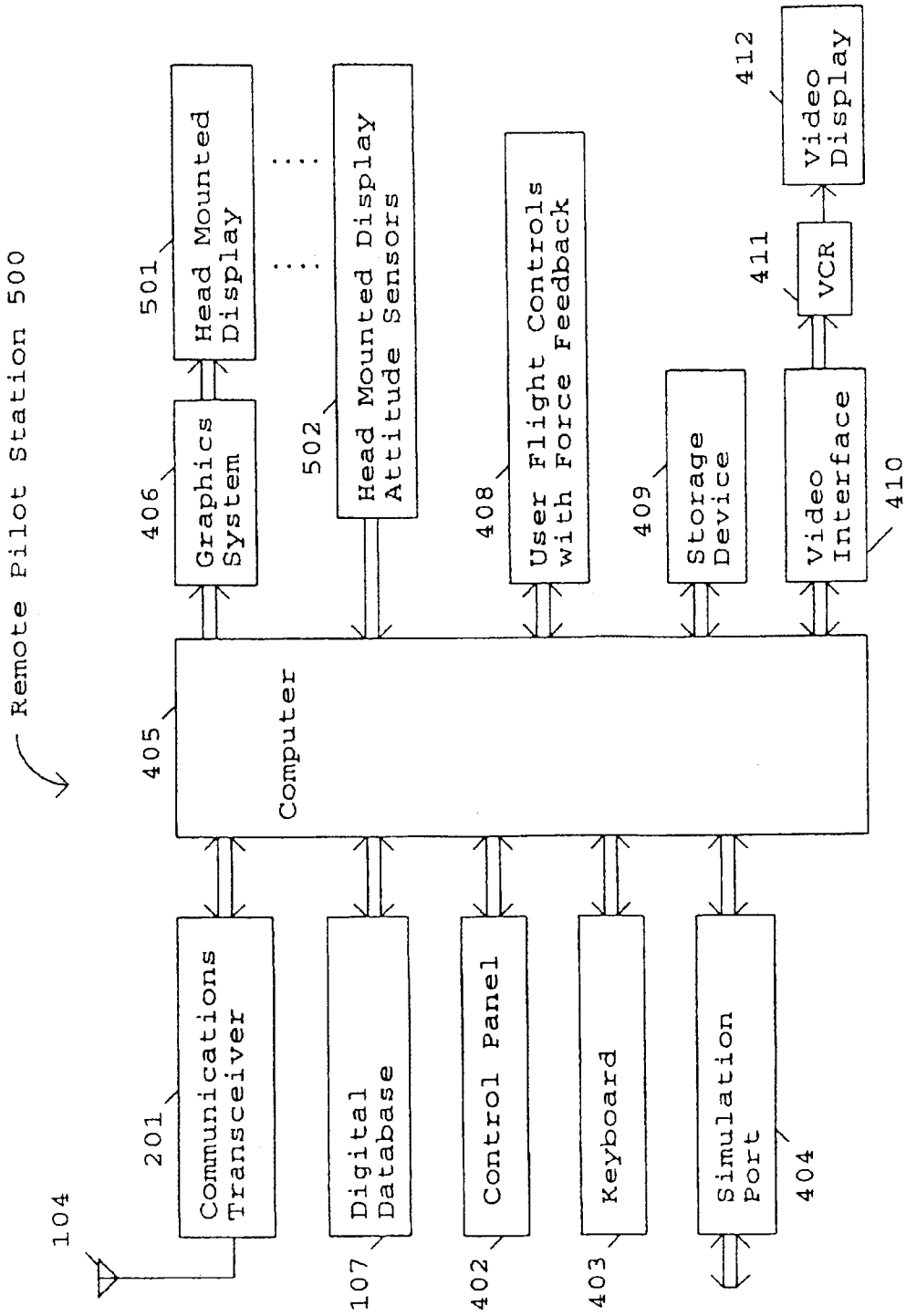

Fig. 5

Remote Aircraft Simulator 600

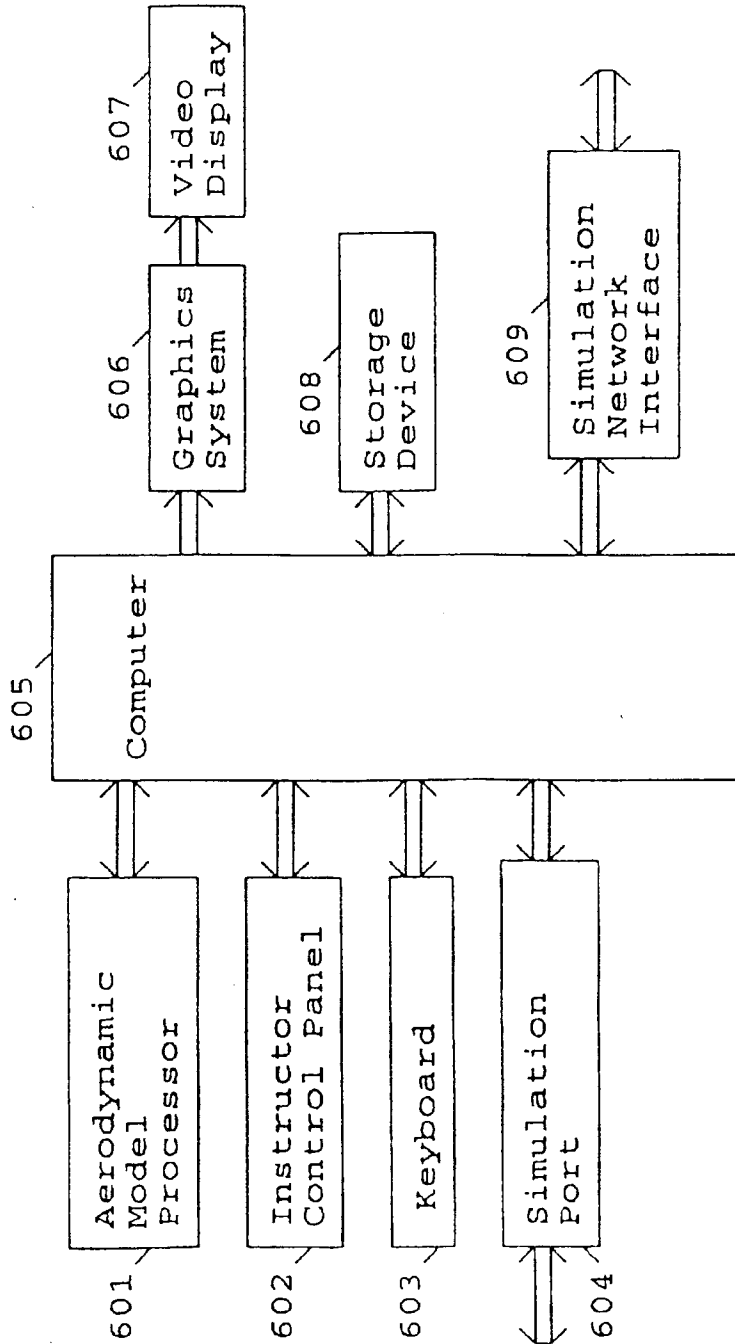

Fig. 6

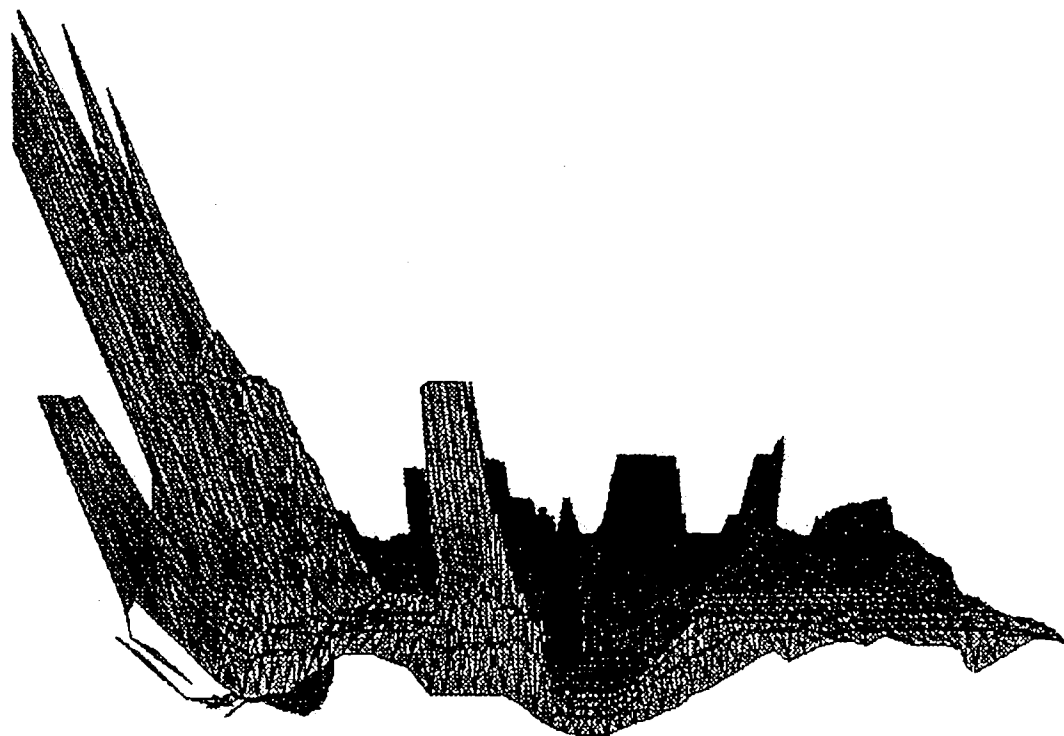

Figure 7

METHOD AND APPARATUS FOR REMOTELY PILOTING AN AIRCRAFT

BACKGROUND OF THE INVENTION—CROSS REFERENCES TO RELATED APPLICATIONS

"Pilot Aid Using a Synthetic Environment", Ser. No. 08/274,394 filed Jul. 11, 1994. "Digital Map Generator and Display System", Ser. No. 08/543,590, filed Oct. 16, 1995.

1. Field of Invention

This invention relates to the field of remotely piloted vehicles (RPVs) and unmanned aerial vehicles (UAVs).

2. Discussion of Prior Art

RPVs can be used for any number of purposes. For example, there is a large organization that promotes the use of remote controlled planes. Certain RPVs are controlled by viewing the plane with the naked eye and using a hand held controller to control its flight. Other RPVs are controlled by a remote pilot using simple joysticks while watching the video produced by a camera in the remote aircraft. This camera is also used to produce the reconnaissance video. There are tradeoffs involving the resolution of the video, the rate at which the video is updated, and the bandwidth needed to transmit it. The wider the bandwidth the more difficult it is to secure the signal. The freedom to balance these tradeoffs is limited because this video is also used to pilot the aircraft and must therefore be updated frequently.

Certain UAVs are preprogrammed to follow a predetermined course and lack the flexibility to deal with unexpected situations.

The 1983 patent to Kanaly (U.S. Pat. No. 4,405,943) shows a control and communications system for a remotely piloted vehicle where an oculometer determines where the remote operator is looking and signals the remote vehicle to send the high resolution imagery corresponding to the area around where the remote operator is looking and low resolution imagery corresponding to the remote operator's peripheral vision. The objective is to minimize the bandwidth of the information transmitted to the remote operator.

SUMMARY

A method and apparatus is described that allows a remote aircraft to be controlled by a remotely located pilot who is presented with a synthesized three-dimensional projected view representing the environment around the remote aircraft. According to one aspect of the invention, a system is used that includes an aircraft and a remote pilot station.

The aircraft uses a communications link to send its location, attitude, and other operating conditions to the remote pilot station. The remote pilot station receives the data and uses a database describing the terrain and manmade structures in the remote aircrafts environment to produce a 3D view of the remote aircraft environment and present it to the remote human pilot.

The remote pilot responds to the information and manipulates the remote flight controls, whose positions and forces are transmitted to the remote aircraft. Since the amount of data is small, it can be readily secured through encryption and spread spectrum techniques.

Also, because the video reconnaissance cameras are no longer needed to remotely pilot the aircraft there is great flexibility in their use. To minimize bandwidth and reduce the possibility of being detected, the video data can be sent at a slow update rate. The data can also be stored on the remote aircraft for later transmission. Alternatively, low resolution pictures can be sent in real-time, while the cor-

responding high resolution pictures can be at a later time. The reconnaissance video can even be transmitted through a different communications link than the control data. There may also be more than one reconnaissance camera.

The delay in the control link must be minimized in order that the remote aircraft can be properly flown. The system can measure the link delay and make this information available to the pilot. This delay link measurement can also be used to modify the control software through which the remote pilot flies the remote aircraft. This is to prevent pilot-induced-oscillation.

The computers in the system allow for several modes of operation. For example, the remote aircraft can be instructed to fly to given coordinates without further input from the remote pilot. It also makes it possible to provide computer assistance to the remote pilot. In this mode, the remote flight control controls absolute pitch and roll angles instead pitch and roll rates which is the normal mode for aircraft. In addition, adverse yaw can be automatically corrected so that the resulting control laws make the remote aircraft extremely easy to fly. Because this comes at the expense of being able to put the remote aircraft into unusual attitudes, for complete control of the remote aircraft a standard control mode is provided to give the remote pilot the same type of control that is used to fly a manned aircraft. Since the remote aircraft is unmanned, the remote pilot can subject the remote aircraft to high-G maneuvers that would not be safe for a pilot present in the aircraft.

To facilitate training, a simulated remote aircraft is provided that allows an instructor to set up the training mission and parameters. This is especially useful in giving remote pilots experience flying with different control link delays. In this simulated mode, the system can be further linked to a battlefield simulator such as SIMNET.

In the first embodiment, the remote pilot is provided with a standard video display. Additional display channels can be provided to give the remote pilot a greater field of view. There can even be a display channel to give a rearward facing view.

A second embodiment uses a head mounted display for the remote pilot instead of a standard display. This permits the remote station to be made more compact so that it can be used in a wider variety of installations. An example would be in a manned aircraft flying several hundred miles away.

BRIEF DESCRIPTION OF THE DRAWINGS

The invention may best be understood by referring to the following description and accompanying drawings which illustrate the invention. In the drawings:

FIG. 1 is a general illustration showing a remote pilot at a remote pilot station operating a remote aircraft according to one embodiment of the invention.

FIG. 2 is a block diagram showing the communications link between a remote pilot station and a remote aircraft according to one embodiment of the invention.

FIG. 3 is a block diagram of a remote aircraft according to one embodiment of the invention.

FIG. 4 is a block diagram of a remote pilot station according to one embodiment of the invention.

FIG. 5 is a block diagram of a remote pilot station according to another embodiment of the invention.

FIG. 6 is a block diagram of a remote aircraft simulator used for training remote pilots according to one embodiment of the invention.

FIG. 7 is an example of a three dimensional projected image presented to a remote pilot by a remote pilot station according to one embodiment of the invention.

DETAILED DESCRIPTION

In the following description, numerous specific details are set forth to provide a thorough understanding of the invention. However, it is understood that the invention may be practiced without these specific details. In other instances, well-known circuits, structures and techniques have not been shown in detail in order not to obscure the invention.

A method and apparatus is described that allows a remote aircraft to be controlled by a remotely located pilot who is presented with a synthesized three-dimensional projected view representing the environment around the remote aircraft. Since the video from a reconnaissance camera located on the remote aircraft is not used to pilot the remote aircraft, the amount of data transmitted between the remote aircraft and the remote pilot is small. This provides greater flexibility in how the remote aircraft is used and allows the transmitted data to be made more secure. The remote aircraft may be of any type, for example a remote control plane or helicopter as used by recreational enthusiast.

FIG. 1 is a general illustration showing a remote pilot at a remote pilot station operating a remote aircraft according to one embodiment of the invention. FIG. 1 shows Remote Pilot 102 interacting with Remote Pilot Station 101 and controlling Remote Aircraft 103. Remote Pilot Station 101 and Remote Aircraft 103 respectively include an Antenna 104 and an Antenna 105 for communicating Information 106.

In one embodiment, Information 106 includes status information concerning the status of Remote Aircraft 103 and flight control information for controlling the flight of Remote Aircraft 103. The status information is generated by Remote Aircraft 103 and includes the three dimensional position and the orientation (also termed attitude, and comprising heading, roll, pitch) of Remote Aircraft 103. The status information may also include information concerning the flight surfaces, the engine, an additional altitude reading, etc. Remote Pilot Station 101 uses this status information to retrieve data from a Digital Database 107 which contains a three-dimensional description of terrain and manmade structures over which Remote Aircraft 103 is flying. Based on the three dimensional data retrieved from Digital Database 107, Remote Pilot Station 101 projects a synthesized three-dimensional projected view of the terrain and manmade structures in the vicinity of Remote Aircraft 103. Based on this view of the terrain and manmade structures, the Remote Pilot Station 101, on its own and/or in response to input from Remote Pilot 102, generates and transmits flight control information to Remote Aircraft 103 which adjusts its flight accordingly.

In one embodiment, the Remote Aircraft 103 is a remote controlled plane or helicopter used for recreational purposes. Since remote controlled planes and helicopters tend to be small in size, the circuitry in such remote aircraft to generate and receive Information 106 is minimized. In such systems, the Remote Pilot Station 101 may be implemented by including additional attachments to an existing portable computer. This allows the user to easily transport the remote aircraft and pilot station to an appropriate location for flight.

FIG. 2 is a block diagram showing a bi-directional communications link between a remote pilot station and a remote aircraft according to one embodiment of the invention. FIG. 2 shows Communications Transceiver 201 coupled to Antenna 104 of Remote Pilot Station 101, as well as Communications Transceiver 204 coupled to Antenna 105 of Remote Aircraft 103. In addition, FIG. 2 shows Information 106 being communicated between Antenna 104 and Antenna 105.

FIG. 3 is a block diagram of a remote aircraft unit used in the remote aircraft according to one embodiment of the invention. FIG. 3 shows Remote Aircraft Unit 300 including Computer 308 coupled to GPS Receiver 301, Turn-and-bank Indicator 302, Gyrocompass 303, Communications Transceiver 204, Aircraft Engine and Sensors 309, and Aircraft Flight Surfaces and Sensors 310. GPS Receiver 301 receives signals from the satellites that make up the global positioning system (GPS) and calculates the aircraft's position in three dimensions. Turn-and-bank Indicator 302 and Gyrocompass 303 provide the aircraft's orientation which comprises heading, roll, and pitch. This data is sent to Computer 308 for transformation into the previously described status information. Computer 308 transmits this status information to Communications Transceiver 204 which produces a radio signal and supplies it to Antenna 105.

The Aircraft Engine and Sensors 309 are coupled to control the aircraft's engine, while the Aircraft Flight Surfaces and Sensors 310 are coupled to control the aircraft's flight surfaces. The flight control information is received from the remote pilot station by Computer 308 through Antenna 105 and Communications Transceiver 204. This flight control information is processed by Computer 308 into the necessary signals for transmission to Aircraft Engine and Sensors 309 and Aircraft Flight Surfaces and Sensors 310 to control the aircraft's engine and flight surfaces, respectively. The operation of the aircraft's flight control surfaces will be later described with reference to FIG. 4.

In order to protect against ECM, the communications link between the Remote Pilot Station 101 and the Remote Aircraft 103 may be secured. While any number of different techniques may be used to secure this link, in one embodiment Computer 308 is implemented to encrypt/decrypt the data transmitted and Communications Transceiver 204 is implemented to use spread spectrum techniques.

Computer 308 may optionally be coupled to Altimeter 304, Video Camera System 305, Infrared Video Camera System 306, Radar 307, and/or Video Storage Unit 311. Altimeter 304 provides an output of the aircraft's altitude as a safety check in the event GPS Receiver 301 malfunctions. Thus, this additional altitude reading may also be transmitted to Remote Pilot Station 101 as part of the status information.

Video Camera System 305 is controlled by Computer 308 which determines where the camera is pointing as well as focusing and the zoom factor. The video produced by the camera is not used by the remote pilot for flying the remote aircraft, so there is more flexibility in using the video. As a result, any number of techniques can be used for receiving the images captured by Video Camera System 305. As examples:

1. High resolution, high update images may be sent back in real-time through the Communications Link, when the high bandwidth needed can be tolerated.
2. High resolution, low update images may be sent back in real-time through the Communications Link to reduce the bandwidth.
3. The video may be recorded in Video Storage Unit 311 for later transmission.
4. The video may be transmitted through a separate communications link.
5. There may be multiple video cameras.

Infrared Video Camera System 306 is similar to Video Camera System 305 and has the same operating modes.

Radar 307 in Remote Aircraft 103 may be passive or active. It may scan a particular pattern or it may track a

selected object. Radar 307 may consist of several Radar units. The information from Radar 307 is processed by Computer 308 so that only the desired information is transmitted over the communication link to the Remote Pilot Station 101 for display.

FIG. 4 is a block diagram of a remote pilot station according to one embodiment of the invention. FIG. 4 shows a Remote Pilot Station 400 including a Computer 405 coupled to Communications Transceiver 201, Digital Database 107, Graphics System 406, User Flight Controls with Force Feedback 408, and a Storage Device 409. The Storage Device 409 represents one or more mechanisms for storing data. For example, the Storage Device 409 may include read only memory (ROM), random access memory (RAM), magnetic disk storage mediums, optical storage mediums, flash memory devices, and/or other machine-readable mediums. Of course, Digital Database 107 may be stored in one or more machine-readable mediums and/or in Storage Device 409.

As previously described, Antenna 104 receives the radio signals transmitted by Remote Aircraft 103 representing the status information of Remote Aircraft 103. These radio signals are transformed by Communications Transceiver 201 and sent to Computer 405. Communications Transceiver 201 is set to the same mode as Communications Transceiver 204, so that if, for example, spread spectrum techniques are used, the signal will be transparently received. Computer 405 recovers the data (de-encrypting, if required) so that the data communications from Computer 308 in the Remote Aircraft to Computer 405 in the Remote Pilot Station is transparent. Thus, the bi-directional communications link comprises the combination of Communications Transceiver 201, Antenna 104, Antenna 105, and Communications Transceiver 204.

As previously described, the status information received by Computer 405 includes the three dimensional position and the orientation of Remote Aircraft 103. The status information may also include information concerning the flight surfaces, flight sensors, the engine, an additional altitude reading, etc. Computer 405 uses this status information to retrieve data from Digital Database 107 which contains a three-dimensional description of terrain and man-made structures over which Remote Aircraft 103 is flying. The composition and creation of the Digital Database 107 is further described later. Based on the three dimensional data retrieved from Digital Database 107, Computer 405 performs the mathematical operations to transform and project the three dimensional data to generate video data representing a synthesized three-dimensional projected view of the terrain (and, if desired, manmade structures) in the vicinity or environment of Remote Aircraft 103. This video data is transmitted to Graphics System 406, which displays the synthesized three-dimensional projected view on Video Display 407.

Since the image is generated from the digital database, virtually any image of the environment of the Remote Aircraft 103 can be generated. As examples, the pilot may select the environment to be: 1) a simulated image of what would be seen out of the cockpit of a manned aircraft on a similar flight path; 2) a simulated image of what would be seen when looking in any direction (e.g., backwards, out a side window, etc.); 3) a simulated image of what would be seen if a camera were tailing the remotely piloted aircraft; etc. In addition, the simulated image may be set to any magnification. Thus, the phrase environment of Remote Aircraft 103 is intended to include any image generated with reference to the remote aircraft's position.

The User Flight controls with Force Feedback 408 are used by the remote pilot to input flight path information. The User Flight Controls may be of any number of different types, some of which are further described later herein. The status information received by Computer 405 also includes information received from Aircraft Flight Surfaces and Sensors 310. This information is used to actuate force feedback circuitry in User Flight Controls With Force Feedback 408. Remote Pilot 102 observes the synthesized three-dimensional environment displayed on Video Display 407, feels the forces on User Flight Controls With Force Feedback 408 and moves the controls accordingly. This flight control information is sent through the communications link, to Computer 308, and is used to control the aircraft flight surfaces in Aircraft Flight Surfaces and Sensors 310. Remote Pilot 102 also receives data from Aircraft Engine and Sensors 309 through the communications link and is able to send data back to control the engine.

Flight Control

To illustrate the operation of the remote aircraft, a fixed-wing airplane will be described as an example. However, the basic principles apply to other types of aircraft as well. The basic control surfaces of an airplane consist of the ailerons, the horizontal elevators, and the rudder. The ailerons are moved differentially (one up, one down) to rotate the airplane around its roll axis; the horizontal elevators cause the airplane to rotate around its pitch axis; and the rudder causes the airplane to rotate around its yaw axis.

When the ailerons are used to modify the lift characteristics of the wings, one wing creates more lift while the other wing creates less lift. This also changes the drag characteristics of the wings and results in a yaw force that is opposite to the yaw force that results from the tail section causing the airplane to weather-cock into the relative wind. It is this yaw force caused by the airplane weather-cocking into the relative wind that causes a banked airplane to turn. The opposite yaw force produced by using the ailerons is called adverse yaw; the rudder control is used to counteract this force to produce a coordinated turn.

The simplest type of flight control consists of a joystick and a set of rudder pedals. The controls are directly connected to the flight control surfaces. With a joystick, moving the stick left and right moves the ailerons, while moving the stick forward and backward moves the horizontal elevators. The rudder is controlled by two foot pedals, one for each foot, that are mounted on a common shaft and hinged in the middle like a seesaw. Pressing one foot pedal forward causes the other foot pedal to move backward and causes the rudder to also move in one direction. Pressing the other foot pedal causes it to move forward and the opposite pedal to move backward and causes the rudder to move in the opposite direction.

An alternative to the joystick is the control yoke which consists of a wheel attached to a shaft that moves in and out of the control housing. Turning the wheel clockwise or counterclockwise moves the ailerons; moving the wheel shaft in and out moves the horizontal elevators. The rudder pedals are the same as those used with a joystick.

In order to aid in a description of remote aircraft operation, it is thought worthwhile to first describe the operation of non-remotely piloted vehicles. Non-remotely piloted vehicles can be operated in one of two ways (also termed as flight control modes); direct control or computer control (also termed as computer mediated).

Direct Control Non-Remotely Piloted Vehicles

When the flight controls are connected directly to the control surfaces the result is a second order system. Using

the joystick as an example, moving the joystick left or right establishes a roll rate. The airplane continues to roll until the joystick is returned to the center position, after which the airplane remains in the bank angle thus established. The foot pedals are used to counteract the adverse yaw as previously described. Moving the joystick forward or backward establishes a pitch rate. The airplane continues to pitch until the joystick is returned to the center position, after which the airplane remains in the pitch angle thus established. Both the roll rate and the pitch rate are subject to the limits of the airplane's design.

Since the joystick is directly connected to the control surfaces, the aerodynamic forces on the control surfaces are transmitted back to the pilot, giving him or her valuable feedback on how the airplane is flying.

The successful operation of the second order system with the pilot in the loop depends on several factors such as the area and placement of the control surfaces, how much the control surfaces move in response to the movement of the pilot controls, and how long the airplane takes to respond to changes of the control surfaces. The total system characteristics also depend on the reaction time of the pilot. If the resulting system is poorly designed it may be unstable, which means it may not be possible for a human pilot to fly it safely. An example of an unstable system is where the pilot desires to perform a gentle roll to the right and so moves the joystick to the right, the airplane's roll rate is faster than the pilot desires so he/she attempts to compensate by moving the joystick to the left, the airplane rolls left at a rate that is faster than the pilot desires so he/she moves the joystick to the right, and so on, with the pilot constantly overcorrecting and with the aircraft's rolling motions constantly getting larger and larger until the aircraft gets into a condition from which it may not be possible to recover, (e.g., spinning into the ground). The type of loss of control described is usually referred to as 'pilot induced oscillation' and although it may be caused by an inexperienced or inattentive pilot, it is more often caused by poor airplane design. Therefore, new airplane designs are extensively tested to make sure they can be safely flown. Examples of airplanes that use direct control of the control surfaces (Direct Control Second Order Systems) are the Cessna 150 and the Piper Cub.

Computer Mediated Non-Remotely Piloted Vehicles

Computer mediated control systems use a computer between the pilot controls and the control surfaces. The pilot controls are read by the computer, the data are modified in a particular way, and the computer sends control signals to the control surfaces. The computer may also sense the forces on the control surface and use it to control force feedback to the pilot controls. This type of computer mediated control may be used to fly an airplane that would otherwise be unstable, such as the F16 or the F117. Aircraft such as the F16 and F117 are also second order systems because the position of the pilot's joystick represents rate of rotation.

There are risks inherent in a computer mediated system. Although the program can be simulated extensively before using it in an actual airplane, the computer program may be quite large and therefore difficult to simulate under all possible conditions. An example of this is the Swedish JAS 39 Gripen Fighter. Despite extensive simulation of the flight control system, during a test flight a Gripen crashed due to "... the flight control system's high amplification of stick commands combined with the pilot's" large, rapid stick movements." The pilot had entered a low-speed high-banked turn at a 280 meter altitude with lit afterburners and

was leaving the turn when his actions led to 'pilot-induced oscillation'. (Aviation Week & Space Technology, Aug. 23, 1993, pages 72-73).

Having described techniques for operating non-remotely piloted vehicles, the Fight Control Modes for RPVs will be described.

Second Order RPV Flight Control Mode

A second order control system for an RPV is inherently computer mediated because the remote pilot must interact through two computers: the computer in the remote aircraft and the computer in the remote pilot station.

Flying an RPV is further complicated because there are additional time delays in the loop. The computer in the remote aircraft must first determine the aircraft's position and orientation. The additional processing for transmitting a secure signal by encryption and/or spread spectrum techniques may create additional delays. Transmission delay of signals between the remote aircraft and remote pilot station is negligible for a direct path. However, if the signals are relayed through other facilities the delay time may be appreciable, especially if an orbiting satellite is used. There are additional delays in the remote pilot station as the remote aircraft's position and orientation are used to transform the data from the digital database to present the pilot with the synthesized 3D projected view from the remote aircraft. In one embodiment, the RPV system measures the various delays and modifies the control laws used by the computer in the remote pilot aircraft and in the feedback provided by the computer in the remote pilot station to the remote pilot. For example, the computer may adjust the sensitivity of the User Flight Controls 408 according to the delay (e.g., as the delay increases, the computer will decrease the sensitivity of the flight controls). The system also displays the measured delay to the remote pilot.

First Order RPV Flight Control Mode

The stability of the flight control system, and thus the flyability of an RPV, can be improved considerably by using a first order system. In one embodiment of such a first order system the position of the remote pilot's joystick represents an angle relative to the horizon, instead of representing a rate of rotation as in a second order system. The position of the joystick is transmitted to the computer in the remote aircraft which moves the control surfaces as required to place the remote aircraft in the requested orientation. The control system in the remote aircraft is still a second order system but the delays in the communications link and the remote pilot station are no longer a part of the system's loop.

When a joystick is centered, the remote aircraft will fly straight and level. When the joystick is to the right of center the remote aircraft will be in a right banked turn. When the joystick is to the left of center the remote aircraft will be in a left banked turn. When the joystick is backward from center the remote aircraft will be in a pitch up orientation. When the joystick is forward of center the remote aircraft will be in a pitch down orientation.

The amount of bank and pitch permitted depends on the design of the remote aircraft. A high performance remote aircraft will be capable of a greater amount of pitch and bank than will a low performance remote aircraft.

Referring again to FIG. 4, Computer 405 may optionally be coupled to Control Panel 402, Keyboard 403, Simulation Port 404, Video Interface 410, VCR 411, and/or Video Display 412. In one embodiment, Control Panel 402 con-

tains specialized lights, displays, and switches to allow a quicker response to situations than can be provided by Keyboard 403. Control Panel 402 can be arranged to approximate the look and feel of an actual aircraft cockpit. Keyboard 403 allows the remote pilot to select various operating modes. For training purposes, Simulation Port 404 allows the remote pilot station to be connected to a remote aircraft simulator instead of an actual remote aircraft. The remote aircraft simulator will be further described with reference to FIG. 6. Storage Device 409 allows the flight data to be recorded. During playback this previously recorded data is substituted for real-time data from the remote aircraft to replay the mission for analysis. Any video received from any reconnaissance cameras on the Remote Aircraft 103 is converted by Video Interface 410 so that it can be recorded on VCR 411 and displayed on Video Display 412. VCR 411 can also operate in straight-through mode so that the reconnaissance video can be viewed in real time.

FIG. 5 is a block diagram of a remote pilot station according to another embodiment of the invention. FIG. 5 shows Remote Pilot Station 500. Remote Pilot Station 500 is similar to Remote Pilot Station 400 of FIG. 4, except Video Display 407 is replaced by Head Mounted Display 501. In addition, Head Mounted Display Attitude Sensors 502 are coupled to Computer 405. Head Mounted Display Attitude Sensors 502 measure the attitude of Head Mounted Display 501. This information is used by Computer 405 to produce an additional three dimensional transformation of the data from Digital Database 107 to account for the attitude of the remote pilots Head Mounted Display 501. This does not require any additional data from the remote aircraft. Of course, alternative embodiments could include both a video display and a head mounted display.

FIG. 6 is a block diagram of a simulated remote aircraft used for training remote pilots according to one embodiment of the invention. FIG. 6 shows Remote Aircraft Simulator 600 including Computer 605 coupled to Aerodynamic Model Processor 601, Instructor Control Panel 602, Keyboard 603, Simulation Port 604, Graphics System 606, Storage Device 608, and Simulation Network Interface 609. Remote Aircraft Simulator 600 communicates with Remote Pilot Station 400 or 500 through Simulation Port 604. Aerodynamic Model Processor 601 executes a mathematical model that simulates the behavior of a remote aircraft. An instructor uses Instructor Control Panel 602 and Keyboard 603 to select various training scenarios. Graphics System 606 and Video Display 607 are used to observe the operation of the system. Storage Device 608 is used to record the training session for later evaluation of the session. In addition to proficiency training, the Remote Aircraft Simulator can also be used to practice a proposed mission. The data communicated to the remote pilot station can include training and evaluation data for processing and/or display. This training and evaluation data can include any relevant information, such as flight path accuracy, etc.

Simulation Network Interface 609 permits participation in a battlefield simulation system such as SIMNET, mixing aircraft, tanks, and ground troops for training in the coordination of mixed forces. Thus, the system is designed to allow for the communication of this battlefield simulation information between the remote aircraft simulator and the remote pilot station. This allows the remote pilot station to display one or more other simulated entities (e.g., tanks, ground troops, other aircraft, etc.) described by the battlefield simulation information.

The Database

The Digital Database 107 can be comprised of any type of data from which a three dimensional image can be gener-

ated. For example, the U.S. Geological Survey (USGS) makes available various databases, two of which are of particular interest. The first is the Digital Elevation Model data which consist of an array of regularly spaced terrain elevations.

The other USGS database is the Digital Line Graph data which includes: political and administrative boundaries; hydrography consisting of all flowing water, standing water, and wetlands; major transportation systems consisting of roads and trails, railroads, pipelines, transmission lines, and airports; and significant manmade structures. The Digital Line Graph data is two-dimensional. In the present invention features such as water, roads, railroads, and pipelines are represented as polygons with elevations determined from the Digital Elevation Model data. Transmission lines and significant manmade structures are defined as three-dimensional objects made of polygons and are placed according to the elevations determined from the Digital Elevation Model data. The different types of objects are tagged so that the remote pilot can select them to be highlighted by category or by specific object.

Data from additional digital databases can also be incorporated. An example of such a database is from Jeppesen Sanderson whose NavData Services division provides aeronautical charts and makes this information available in digital form.

The procedure for generating the synthesized three-dimensional view from the Digital Database may use any number of techniques, including those disclosed in the 1987 patent to Beckwith et al. (U.S. Pat. No. 4,660,157 REAL TIME VIDEO PERSPECTIVE DIGITAL MAP DISPLAY METHOD), and the 1993 patent to Dawson et al. (U.S. Pat. No. 5,179,638 METHOD AND APPARATUS FOR GENERATING A TEXTURE MAPPED PERSPECTIVE VIEW). One disadvantage of generating the synthesized three-dimensional view from these elevation databases in real time is the amount of storage space they require. To avoid this large amount of data storage, one embodiment of Digital Database 107 is composed of terrain data that represents the real terrain using polygons. This database may be generated using any number of techniques. For example, this database may be generated by transforming one or more elevation databases into a polygon database using the technique taught in "Pilot Aid Using a Synthetic Environment", Ser. No. 08/274,394 filed Jul. 11, 1994. Another method for transforming one or more elevation databases into a polygon database is taught in "Digital Map Generator and Display System", Ser. No. 08/543,590, filed Oct. 16, 1995. An example of a three dimensional projected image created from this database is shown in FIG. 7.

While the invention has been described in terms of several embodiments, those skilled in the art will recognize that the invention is not limited to the embodiments described. The method and apparatus of the invention can be practiced with modification and alteration within the spirit and scope of the appended claims. The description is thus to be regarded as illustrative instead of limiting on the invention.

What is claimed is:

1. A system comprising:

- a remotely piloted aircraft including,
 - a position determining system to locate said remotely piloted aircraft's position in three dimensions; and
 - an orientation determining system for determining said remotely piloted aircraft's orientation in three dimensional space;
- a communications system for communicating flight data between a computer and said remotely piloted aircraft,

11

- said flight data including said remotely piloted aircraft's position and orientation, said flight data also including flight control information for controlling said remotely piloted aircraft;
- a digital database comprising terrain data;
- said computer to access said terrain data according to said remotely piloted aircraft's position and to transform said terrain data to provide three dimensional projected image data according to said remotely piloted aircraft's orientation;
- a display for displaying said three dimensional projected image data; and
- a set of one or more remote flight controls coupled to said computer for inputting said flight control information, wherein said computer is also for determining a delay time for communicating said flight data between said computer and said remotely piloted aircraft, and wherein said computer adjusts the sensitivity of said set of one or more remote flight controls based on said delay time.
2. The system of claim 1, wherein:
- said remotely piloted aircraft includes a device for capturing image data; and
- said system operates in at least a first mode in which said image data is not transmitted from said remotely piloted aircraft to said computer at a sufficient data rate to allow for real time piloting of the remotely piloted aircraft.
3. The system of claim 1, wherein the flight data communicated between said remotely piloted aircraft and said computer is secured.
4. The system of claim 1, wherein said remotely piloted aircraft further comprises a set of one or more video cameras.
5. The system of claim 4, wherein said communications system is also for communicating video data representing images captured by said set of one or more video cameras, said video data for displaying said images.
6. The system of claim 5, wherein said video data is transmitted on a different communication link than said flight data.
7. The system of claim 4, wherein at least one camera in said set of one or more video cameras is an infrared camera.
8. The system of claim 1, wherein said display is a head mounted display.
9. The system of claim 1, wherein said set of one or more remote flight controls is responsive to manual manipulations.
10. The system of claim 1, wherein said set of one or more remote flight controls allows for inputting absolute pitch and roll angles instead of pitch and roll rates.
11. The system of claim 1, wherein said computer is also used for correcting adverse yaw without requiring input from said set of one or more remote flight controls.

12

12. The system of claim 1, wherein:
- said remotely piloted aircraft includes a device for capturing image data; and said system operates in at least a first mode in which said image data is not transmitted from said remotely piloted craft to said computer but stored in said remotely piloted aircraft.
13. A station for flying a remotely piloted aircraft that is real or simulated comprising:
- a database comprising terrain data;
- a set of remote flight controls for inputting flight control information;
- a computer having a communications unit configured to receive status information identifying said remotely piloted aircraft's position and orientation in three dimensional space, said computer configured to access said terrain data according to said status information and configured to transform said terrain data to provide three dimensional projected image data representing said remotely piloted aircraft's environment, said computer coupled to said set of remote flight controls and said communications unit for transmitting said flight control information to control said remotely piloted aircraft, said computer also to determine a delay time for communicating said flight control information between said computer and said remotely piloted aircraft, and said computer to adjust the sensitivity of said set of remote flight controls based on said delay time; and
- a display configured to display said three dimensional projected image data.
14. The station of claim 13, wherein said communications unit is also configured to receive video data representing images captured by a set of video cameras on said remotely piloted aircraft, said video data for displaying said images.
15. The station of claim 14, wherein said video data is transmitted on a different communication link than said flight control information and said status information.
16. The station of claim 13, wherein said display is a head mounted display.
17. The station of claim 13, wherein said set of remote flight controls is responsive to manual manipulations.
18. The station of claim 13, wherein said set of remote flight controls are configured to allow inputting absolute pitch and roll angles instead of pitch and roll rates.
19. The station of claim 13, wherein said computer is also configured to correct adverse yaw without requiring input from said set of remote flight controls.
20. The station of claim 13, wherein said communications unit includes at least one of a communications transceiver and a simulation port.

* * * * *

PATENT APPLICATION SERIAL NO. 08/587731

U.S. DEPARTMENT OF COMMERCE
PATENT AND TRADEMARK OFFICE
FEE RECORD SHEET

01469

280 JS 02/09/96 08587731

1 201 772.00 CK



2055.P004

Patent

UNITED STATES PATENT APPLICATION

FOR

A METHOD AND APPARATUS FOR REMOTELY PILOTING AN AIRCRAFT

INVENTORS:

JED MARGOLIN

PREPARED BY:

BLAKELY, SOKOLOFF, TAYLOR & ZAFMAN
12400 WILSHIRE BOULEVARD
SEVENTH FLOOR
LOS ANGELES, CA 90025-1026

(408) 720-8598

EXPRESS MAIL CERTIFICATE OF MAILING

"Express Mail" mailing label number EM281965992US

Date of Deposit January 19, 1996

I hereby certify that this paper or fee is being deposited with the United States Postal Service "Express Mail Post Office to Addressee" service under 37 CFR 1.10 on the date indicated above and is addressed to the Commissioner of Patents and Trademarks, Washington, D.C. 20231.

Dulcie G. Stinson
(Typed or printed name of person mailing paper or fee)

Dulcie G. Stinson
(Signature of person mailing paper or fee)

01470

08/587731

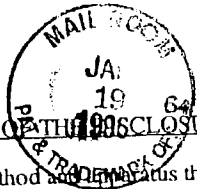

ABSTRACT OF THE DISCLOSURE

A method and apparatus that allows a remote aircraft to be controlled by a remotely located pilot who is presented with a synthesized three-dimensional projected view representing the environment around the remote aircraft. According to one aspect of the invention, a remote aircraft transmits its three-dimensional position and orientation to a remote pilot station. The remote pilot station applies this information to a digital database containing a three dimensional description of the environment around the remote aircraft to present the remote pilot with a three dimensional projected view of this environment. The remote pilot reacts to this view and interacts with the pilot controls, whose signals are transmitted back to the remote aircraft. In addition, the system compensates for the communications delay between the remote aircraft and the remote pilot station by controlling the sensitivity of the pilot controls.

01471

7

772-201

08/587731 A



-1-

A METHOD AND APPARATUS FOR REMOTELY PILOTING AN AIRCRAFT

BACKGROUND OF THE INVENTION - Cross References to Related Applications

"Pilot Aid Using a Synthetic Environment", serial no. 08/274,394 filed July
 5 11, 1994. "Digital Map Generator and Display System", serial no. 08/543,590 , filed
 October 16, 1995.

BACKGROUND OF THE INVENTION - Field of Invention

This invention relates to the field of remotely piloted vehicles (RPVs) and
 10 unmanned aerial vehicles (UAVs).

BACKGROUND OF THE INVENTION - Discussion of Prior Art

RPVs can be used for any number of purposes. For example, there is a large
 organization that promotes the use of remote controlled planes. Certain RPVs are
 15 controlled by viewing the plane with the naked eye and using a hand held controller to
 control its flight. Other RPVs are controlled by a remote pilot using simple joysticks
 while watching the video produced by a camera in the remote aircraft. This camera is
 also used to produce the reconnaissance video. There are tradeoffs involving the
 resolution of the video, the rate at which the video is updated, and the bandwidth
 20 needed to transmit it. The wider the bandwidth the more difficult it is to secure the
 signal. The freedom to balance these tradeoffs is limited because this video is also
 used to pilot the aircraft and must therefore be updated frequently.

2

Certain UAVs are preprogrammed to follow a predetermined course and lack the flexibility to deal with unexpected situations.

The 1983 patent to Kanaly (U.S. Patent No. 4,405,943) shows a control and communications system for a remotely piloted vehicle where an oculometer determines
5 where the remote operator is looking and signals the remote vehicle to send the high resolution imagery corresponding to the area around where the remote operator is looking and low resolution imagery corresponding to the remote operator's peripheral vision. The objective is to minimize the bandwidth of the information transmitted to the remote operator.

01473

SUMMARY

A method and apparatus is described that allows a remote aircraft to be controlled by a remotely located pilot who is presented with a synthesized three-dimensional projected view representing the environment around the remote aircraft.

5 According to one aspect of the invention, a system is used that includes an aircraft and a remote pilot station.

The aircraft uses a communications link to send its location, attitude, and other operating conditions to the remote pilot station. The remote pilot station receives the data and uses a database describing the terrain and manmade structures in the remote aircraft's environment to produce a 3D view of the remote aircraft's environment and
10 present it to the remote human pilot.

The remote pilot responds to the information and manipulates the remote flight controls, whose positions and forces are transmitted to the remote aircraft. Since the amount of data is small, it can be readily secured through encryption and spread-
15 spectrum techniques.

Also, because the video reconnaissance cameras are no longer needed to remotely pilot the aircraft there is great flexibility in their use. To minimize bandwidth and reduce the possibility of being detected, the video data can be sent at a slow update rate. The data can also be stored on the remote aircraft for later transmission.
20 Alternatively, low resolution pictures can be sent in real-time, while the corresponding high resolution pictures can be at a later time. The reconnaissance video can even be transmitted through a different communications link than the control data. There ^{may} ~~many~~ also be more than one reconnaissance camera.

6

9

01474

The delay in the control link must be minimized in order that the remote aircraft can be properly flown. The system can measure the link delay and make this information available to the pilot. This delay link measurement can also be used to modify the control software through which the remote pilot flies the remote aircraft.

5 This is to prevent pilot-induced-oscillation.

The computers in the system allow for several modes of operation. For example, the remote aircraft can be instructed to fly to given coordinates without further input from the remote pilot. It also makes it possible to provide computer assistance to the remote pilot. In this mode, the remote flight control controls absolute
10 pitch and roll angles instead pitch and roll rates which is the normal mode for aircraft. In addition, adverse yaw can be automatically corrected so that the resulting control laws make the remote aircraft extremely easy to fly. Because this comes at the expense of being able to put the remote aircraft into unusual attitudes, for complete control of the remote aircraft a standard control mode is provided to give the remote pilot the
15 same type of control that is used to fly a manned aircraft. Since the remote aircraft is unmanned, the remote pilot can subject the remote aircraft to high-G maneuvers that would not be safe for a pilot present in the aircraft.

To facilitate training, a simulated remote aircraft is provided that allows an instructor to set up the training mission and parameters. This is especially useful in
20 giving remote pilots experience flying with different control link delays. In this simulated mode, the system can be further linked to a battlefield simulator such as SIMNET.

01475

In the first embodiment, the remote pilot is provided with a standard video display. Additional display channels can be provided to give the remote pilot a greater field of view. There can even be a display channel to give a rearward facing view.

A second embodiment uses a head mounted display for the remote pilot instead
5 of a standard display. This permits the remote station to be made more compact so that it can be used in a wider variety of installations. An example would be in a manned aircraft flying several hundred miles away.

01476

BRIEF DESCRIPTION OF THE DRAWINGS

The invention may best be understood by referring to the following description and accompanying drawings which illustrate the invention. In the drawings:

FIG. 1 is a general illustration showing a remote pilot at a remote pilot station
5 operating a remote aircraft according to one embodiment of the invention.

FIG. 2 is a block diagram showing the communications link between a remote pilot station and a remote aircraft according to one embodiment of the invention.

FIG. 3 is a block diagram of a remote aircraft according to one embodiment of the invention.

10 FIG. 4 is a block diagram of a remote pilot station according to one embodiment of the invention.

FIG. 5 is a block diagram of a remote pilot station according to another embodiment of the invention.

15 FIG. 6 is a block diagram of a remote aircraft simulator used for training remote pilots according to one embodiment of the invention.

FIG. 7 is an example of a three dimensional projected image presented to a remote pilot by a remote pilot station according to one embodiment of the invention.

01477

DETAILED DESCRIPTION

In the following description, numerous specific details are set forth to provide a thorough understanding of the invention. However, it is understood that the invention may be practiced without these specific details. In other instances, well-
5 known circuits, structures and techniques have not been shown in detail in order not to obscure the invention.

A method and apparatus is described that allows a remote aircraft to be controlled by a remotely located pilot who is presented with a synthesized three-dimensional projected view representing the environment around the remote aircraft.
10 Since the video from a reconnaissance camera located on the remote aircraft is not used to pilot the remote aircraft, the amount of data transmitted between the remote aircraft and the remote pilot is small. This provides greater flexibility in how the remote aircraft is used and allows the transmitted data to be made more secure. The remote aircraft may be of any type, for example a remote control plane or helicopter as
15 used by recreational enthusiast.

FIG. 1 is a general illustration showing a remote pilot at a remote pilot station operating a remote aircraft according to one embodiment of the invention. FIG. 1 shows Remote Pilot 102 interacting with Remote Pilot Station 101 and controlling Remote Aircraft 103. Remote Pilot Station 101 and Remote Aircraft 103 respectively
20 include an Antenna 104 and an Antenna 105 for communicating Information 106.

In one embodiment, Information 106 includes status information concerning the status of Remote Aircraft 103 and flight control information for controlling the flight of Remote Aircraft 103. The status information is generated by Remote Aircraft

01473

103 and includes the three dimensional position and the orientation (also termed attitude, and comprising heading, roll, pitch) of Remote Aircraft 103. The status information may also include information concerning the flight surfaces, the engine, an additional altitude reading, etc. Remote Pilot Station 101 uses this status
5 information to retrieve data from a Digital Database 107 which contains a three-dimensional description of terrain and manmade structures over which Remote Aircraft 103 is flying. Based on the three dimensional data retrieved from Digital Database 107, Remote Pilot Station 101 projects a synthesized three-dimensional projected view of the terrain and manmade structures in the vicinity of Remote Aircraft
10 103. Based on this view of the terrain and manmade structures, the Remote Pilot Station 101, on its own and/or in response to input from Remote Pilot 102, generates and transmits flight control information to Remote Aircraft 103 which adjusts its flight accordingly.

In one embodiment, the Remote Aircraft 103 is a remote controlled plane or
15 helicopter used for recreational purposes. Since remote controlled planes and helicopters tend to be small in size, the circuitry in such remote aircraft to generate and receive Information 106 is minimized. In such systems, the Remote Pilot Station 101 may be implemented by including additional attachments to an existing portable computer. This allows the user to easily transport the remote aircraft and pilot station
20 to an appropriate location for flight.

FIG. 2 is a block diagram showing a bi-directional communications link between a remote pilot station and a remote aircraft according to one embodiment of the invention. FIG. 2 shows Communications Transceiver 201 coupled to Antenna

01479

104 of Remote Pilot Station 101, as well as Communications Transceiver 204 coupled to Antenna 105 of Remote Aircraft 103. In addition, FIG. 2 shows Information 106 being communicated between Antenna 104 and Antenna 105.

FIG. 3 is a block diagram of a remote aircraft unit used in the remote aircraft according to one embodiment of the invention. FIG. 3 shows Remote Aircraft Unit 300 including Computer 308 coupled to GPS Receiver 301, Turn-and-bank Indicator 302, Gyrocompass 303, Communications Transceiver 204, Aircraft Engine and Sensors 309, and Aircraft Flight Surfaces and Sensors 310. GPS Receiver 301 receives signals from the satellites that make up the global positioning system (GPS) and calculates the aircraft's position in three dimensions. Turn-and-bank Indicator 302 and Gyrocompass 303 provide the aircraft's orientation which comprises heading, roll, and pitch. This data is sent to Computer 308 for transformation into the previously described status information. Computer 308 transmits this status information to Communications Transceiver 204 which produces a radio signal and supplies it to Antenna 105.

The Aircraft Engine and Sensors 309 are coupled to control the aircraft's engine, while the Aircraft Flight Surfaces and Sensors 310 are coupled to control the aircraft's flight surfaces. The flight control information is received from the remote pilot station by Computer 308 through Antenna 105 and Communications Transceiver 204. This flight control information is processed by Computer 308 into the necessary signals for transmission to Aircraft Engine and Sensors 309 and Aircraft Flight Surfaces and Sensors 310 to control the aircraft's engine and flight surfaces,

01400

respectively. The operation of the aircraft's flight control surfaces will be later described with reference to FIG. 4.

In order to protect against ECM, the communications link between the Remote Pilot Station 101 and the Remote Aircraft 103 may be secured. While any number of
5 different techniques may be used to secure this link, in one embodiment Computer 308 is implemented to encrypt/decrypt the data transmitted and Communications Transceiver 204 is implemented to use spread spectrum techniques.

Computer 308 may optionally be coupled to Altimeter 304, Video Camera System 305, Infrared Video Camera System 306, Radar 307, and/or Video Storage
10 Unit 311. Altimeter 304 provides an output of the aircraft's altitude as a safety check in the event GPS Receiver 301 malfunctions. Thus, this additional altitude reading may also be transmitted to Remote Pilot Station 101 as part of the status information.

Video Camera System 305 is controlled by Computer 308 which determines where the camera is pointing as well as focusing and the zoom factor. The video
15 produced by the camera is not used by the remote pilot for flying the remote aircraft, so there is more flexibility in using the video. As a result, any number of techniques can be used for receiving the images captured by Video Camera System 305. As examples:

1. High resolution, high update images may be sent back in real-time through
20 the Communications Link, when the high bandwidth needed can be tolerated.
2. High resolution, low update images may be sent back in real-time through the Communications Link to reduce the bandwidth.

01481

3. The video may be recorded in Video Storage Unit 311 for later transmission.

4. The video may be transmitted through a separate communications link.

5. There may be multiple video cameras.

5 Infrared Video Camera System 306 is similar to Video Camera System 305 and has the same operating modes.

Radar 307 in Remote Aircraft 103 may be passive or active. It may scan a particular pattern or it may track a selected object. Radar 307 may consist of several Radar units. The information from Radar 307 is processed by Computer 308 so that
10 only the desired information is transmitted over the communication link to the Remote Pilot Station 101 for display.

FIG. 4 is a block diagram of a remote pilot station according to one embodiment of the invention. FIG. 4 shows a Remote Pilot Station 400 including a Computer 405 coupled to Communications Transceiver 201, Digital Database 107,
15 Graphics System 406, User Flight Controls with Force Feedback 408, and a Storage Device 409. The Storage Device 409 represents one or more mechanisms for storing data. For example, the Storage Device 409 may include read only memory (ROM), random access memory (RAM), magnetic disk storage mediums, optical storage mediums, flash memory devices, and/or other machine-readable mediums. Of course,
20 Digital Database 107 may be stored in one or more machine-readable mediums and/or in Storage Device 409.

As previously described, Antenna 104 receives the radio signals transmitted by Remote Aircraft 103 representing the status information of Remote Aircraft 103.

01482

These radio signals are transformed by Communications Transceiver 201 and sent to Computer 405. Communications Transceiver 201 is set to the same mode as Communications Transceiver 204, so that if, for example, spread spectrum techniques are used, the signal will be transparently received. Computer 405 recovers the data
5 (de-encrypting, if required) so that the data communications from Computer 308 in the Remote Aircraft to Computer 405 in the Remote Pilot Station is transparent. Thus, the bi-directional communications link comprises the combination of Communications Transceiver 201, Antenna 104, Antenna 105, and Communications Transceiver 204.

As previously described, the status information received by Computer 405
10 includes the three dimensional position and the orientation of Remote Aircraft 103. The status information may also include information concerning the flight surfaces, flight sensors, the engine, an additional altitude reading, etc. Computer 405 uses this status information to retrieve data from Digital Database 107 which contains a three-dimensional description of terrain and manmade structures over which Remote
15 Aircraft 103 is flying. The composition and creation of the Digital Database 107 is further described later. Based on the three dimensional data retrieved from Digital Database 107, Computer 405 performs the mathematical operations to transform and project the three dimensional data to generate video data representing a synthesized three-dimensional projected view of the terrain (and, if desired, manmade structures)
20 in the vicinity or environment of Remote Aircraft 103. This video data is transmitted to Graphics System 406, which displays the synthesized three-dimensional projected view on Video Display 407.

01483

Since the image is generated from the digital database, virtually any image of the environment of the Remote Aircraft 103 can be generated. As examples, the pilot may select the environment to be: 1) a simulated image of what would be seen out of the cockpit of a manned aircraft on a similar flight path; 3) a simulated image of what would be seen when looking in any direction (e.g., backwards, out a side window, etc.); 3) a simulated image of what would be seen if a camera were tailing the remotely piloted aircraft; etc. In addition, the simulated image may be set to any magnification. Thus, the phrase environment of Remote Aircraft 103 is intended to include any image generated with reference to the remote aircraft's position.

10 The User Flight controls with Force Feedback 408 are used by the remote pilot to input flight path information. The User Flight Controls may be of any number of different types, some of which are further described later herein. The status information received by Computer 405 also includes information received from Aircraft Flight Surfaces and Sensors 310. This information is used to actuate force
15 feedback circuitry in User Flight Controls With Force Feedback 408. Remote Pilot 102 observes the synthesized three-dimensional environment displayed on Video Display 407, feels the forces on User Flight Controls With Force Feedback 408 and moves the controls accordingly. This flight control information is sent through the communications link, to Computer 308, and is used to control the aircraft flight
20 surfaces in Aircraft Flight Surfaces and Sensors 310. Remote Pilot 102 also receives data from Aircraft Engine and Sensors 309 through the communications link and is able to send data back to control the engine.

01434

Flight Control

To illustrate the operation of the remote aircraft, a fixed-wing airplane will be described as an example. However, the basic principles apply to other types of aircraft as well. The basic control surfaces of an airplane consist of the ailerons, the horizontal elevators, and the rudder. The ailerons are moved differentially (one up, one down) to rotate the airplane around its roll axis; the horizontal elevators cause the airplane to rotate around its pitch axis; and the rudder causes the airplane to rotate around its yaw axis.

When the ailerons are used to modify the lift characteristics of the wings, one wing creates more lift while the other wing creates less lift. This also changes the drag characteristics of the wings and results in a yaw force that is opposite to the yaw force that results from the tail section causing the airplane to weather-cock into the relative wind. It is this yaw force caused by the airplane weather-cocking into the relative wind that causes a banked airplane to turn. The opposite yaw force produced by using the ailerons is called adverse yaw; the rudder control is used to counteract this force to produce a coordinated turn.

The simplest type of flight control consists of a joystick and a set of rudder pedals. The controls are directly connected to the flight control surfaces. With a joystick, moving the stick left and right moves the ailerons, while moving the stick forward and backward moves the horizontal elevators. The rudder is controlled by two foot pedals, one for each foot, that are mounted on a common shaft and hinged in the middle like a seesaw. Pressing one foot pedal forward causes the other foot pedal to move backward and causes the rudder to also move in one direction. Pressing the

01485

other foot pedal causes it to move forward and the opposite pedal to move backward and causes the rudder to move in the opposite direction.

An alternative to the joystick is the control yoke which consists of a wheel attached to a shaft that moves in and out of the control housing. Turning the wheel
5 clockwise or counterclockwise moves the ailerons; moving the wheel shaft in and out moves the horizontal elevators. The rudder pedals are the same as those used with a joystick.

In order to aid in a description of remote aircraft operation, it is thought worthwhile to first describe the operation of non-remotely piloted vehicles. Non-
10 remotely piloted vehicles can be operated in one of two ways (also termed as flight control modes); direct control or computer control (also termed as computer mediated).

Direct Control Non-Remotely Piloted Vehicles

When the flight controls are connected directly to the control surfaces the result
15 is a second order system. Using the joystick as an example, moving the joystick left or right establishes a roll rate. The airplane continues to roll until the joystick is returned to the center position, after which the airplane remains in the bank angle thus established. The foot pedals are used to counteract the adverse yaw as previously described. Moving the joystick forward or backward establishes a pitch rate. The
20 airplane continues to pitch until the joystick is returned to the center position, after which the airplane remains in the pitch angle thus established. Both the roll rate and the pitch rate are subject to the limits of the airplane's design.

01436

Since the joystick is directly connected to the control surfaces, the aerodynamic forces on the control surfaces are transmitted back to the pilot, giving him or her valuable feedback on how the airplane is flying.

5 The successful operation of the second order system with the pilot in the loop depends on several factors such as the area and placement of the control surfaces, how much the control surfaces move in response to the movement of the pilot controls, and how long the airplane takes to respond to changes of the control surfaces. The total system characteristics also depend on the reaction time of the pilot. If the resulting system is poorly designed it may be unstable, which means it may not be possible for
10 a human pilot to fly it safely. An example of an unstable system is where the pilot desires to perform a gentle roll to the right and so moves the joystick to the right, the airplane's roll rate is faster than the pilot desires so he/she attempts to compensate by moving the joystick to the left, the airplane rolls left at a rate that is faster than the pilot desires so he/she moves the joystick to the right, and so on, with the pilot constantly
15 overcorrecting and with the aircraft's rolling motions constantly getting larger and larger until the aircraft gets into a condition from which it may not be possible to recover, (e.g., spinning into the ground). The type of loss of control described is usually referred to as 'pilot induced oscillation' and although it may be caused by an inexperienced or inattentive pilot, it is more often caused by poor airplane design.
20 Therefore, new airplane designs are extensively tested to make sure they can be safely flown. Examples of airplanes that use direct control of the control surfaces (Direct Control Second Order Systems) are the Cessna 150 and the Piper Cub.

01487

Computer Mediated Non-Remotely Piloted Vehicles

Computer mediated control systems use a computer between the pilot controls and the control surfaces. The pilot controls are read by the computer, the data are modified in a particular way, and the computer sends control signals to the control surfaces. The computer may also sense the forces on the control surface and use it to control force feedback to the pilot controls. This type of computer mediated control may be used to fly an airplane that would otherwise be unstable, such as the F16 or the F117. Aircraft such as the F16 and F117 are also second order systems because the position of the pilot's joystick represents rate of rotation.

10 There are risks inherent in a computer mediated system. Although the program can be simulated extensively before using it in an actual airplane, the computer program may be quite large and therefore difficult to simulate under all possible conditions. An example of this is the Swedish JAS 39 Gripen Fighter. Despite extensive simulation of the flight control system, during a test flight a Gripen
15 crashed due to "...the flight control system's high amplification of stick commands combined with the pilot's" large, rapid stick movements". The pilot had entered a low-speed high-banked turn at a 280 meter altitude with lit afterburners and was leaving the turn when his actions led to 'pilot-induced oscillation'. (Aviation Week & Space Technology, August 23, 1993, pages 72-73).

20 Having described techniques for operating non-remotely piloted vehicles, the Fight Control Modes for RPVs will be described.

01488

Second Order RPV Flight Control Mode

A second order control system for an RPV is inherently computer mediated because the remote pilot must interact through two computers: the computer in the remote aircraft and the computer in the remote pilot station.

5 Flying an RPV is further complicated because there are additional time delays in the loop. The computer in the remote aircraft must first determine the aircraft's position and orientation. The additional processing for transmitting a secure signal by encryption and/or spread spectrum techniques may create additional delays. Transmission delay of signals between the remote aircraft and remote pilot station is
10 negligible for a direct path. However, if the signals are relayed through other facilities the delay time may be appreciable, especially if an orbiting satellite is used. There are additional delays in the remote pilot station as the remote aircraft's position and orientation are used to transform the data from the digital database to present the pilot with the synthesized 3D projected view from the remote aircraft. In one embodiment,
15 the RPV system measures the various delays and modifies the control laws used by the computer in the remote pilot aircraft and in the feedback provided by the computer in the remote pilot station to the remote pilot. For example, the computer may adjust the sensitivity of the User Flight Controls 408 according to the delay (e.g., as the delay increases, the computer will decrease the sensitivity of the flight controls). The
20 system also displays the measured delay to the remote pilot.

First Order RPV Flight Control Mode

The stability of the flight control system, and thus the flyability of an RPV, can be improved considerably by using a first order system. In one embodiment of

01489

such a first order system the position of the remote pilot's joystick represents an angle relative to the horizon, instead of representing a rate of rotation as in a second order system. The position of the joystick is transmitted to the computer in the remote aircraft which moves the control surfaces as required to place the remote aircraft in the requested orientation. The control system in the remote aircraft is still a second order
5 system but the delays in the communications link and the remote pilot station are no longer a part of the system's loop.

When a joystick is centered, the remote aircraft will fly straight and level. When the joystick is to the right of center the remote aircraft will be in a right banked
10 turn. When the joystick is to the left of center the remote aircraft will be in a left banked turn. When the joystick is backward from center the remote aircraft will be in a pitch up orientation. When the joystick is forward of center the remote aircraft will be in a pitch down orientation.

The amount of bank and pitch permitted depends on the design of the remote
15 aircraft. A high performance remote aircraft will be capable of a greater amount of pitch and bank than will a low performance remote aircraft.

Referring again to FIG. 4, Computer 405 may optionally be coupled to Control Panel 402, Keyboard 403, Simulation Port 404, Video Interface 410, VCR 411, and/or Video Display 412. In one embodiment, Control Panel 402 contains
20 specialized lights, displays, and switches to allow a quicker response to situations than can be provided by Keyboard 403. Control Panel 402 can be arranged to approximate the look and feel of an actual aircraft cockpit. Keyboard 403 allows the remote pilot to select various operating modes. For training purposes, Simulation Port

01490

404 allows the remote pilot station to be connected to a remote aircraft simulator instead of an actual remote aircraft. The remote aircraft simulator will be further described with reference to FIG. 6. Storage Device 409 allows the flight data to be recorded. During playback this previously recorded data is substituted for real-time data from the remote aircraft to replay the mission for analysis. Any video received from any reconnaissance cameras on the Remote Aircraft 103 is converted by Video Interface 410 so that it can be recorded on VCR 411 and displayed on Video Display 412. VCR 411 can also operate in straight-through mode so that the reconnaissance video can be viewed in real time.

FIG. 5 is a block diagram of a remote pilot station according to another embodiment of the invention. FIG. 5 shows Remote Pilot Station 500. Remote Pilot Station 500 is similar to Remote Pilot Station 400 of FIG. 4, except Video Display 407 is replaced by Head Mounted Display 501. In addition, Head Mounted Display Attitude Sensors 502 are coupled to Computer 405. Head Mounted Display Attitude Sensors 502 measure the attitude of Head Mounted Display 501. This information is used by Computer 405 to produce an additional three dimensional transformation of the data from Digital Database 107 to account for the attitude of the remote pilot's Head Mounted Display 501. This does not require any additional data from the remote aircraft. Of course, alternative embodiments could include both a video display and a head mounted display.

FIG. 6 is a block diagram of a simulated remote aircraft used for training remote pilots according to one embodiment of the invention. FIG. 6 shows Remote Aircraft Simulator 600 including Computer 605 coupled to Aerodynamic Model

01491

Processor 601, Instructor Control Panel 602, Keyboard 603, Simulation Port 604,
Graphics System 606, Storage Device 608, and Simulation Network Interface 609.
Remote Aircraft Simulator 600 communicates with Remote Pilot Station 400 or 500
through Simulation Port 604. Aerodynamic Model Processor 601 executes a
5 mathematical model that simulates the behavior of a remote aircraft. An instructor uses
Instructor Control Panel 602 and Keyboard 603 to select various training scenarios.
Graphics System 606 and Video Display 607 are used to observe the operation of the
system. Storage Device 608 is used to record the training session for later evaluation
of the session. In addition to proficiency training, the Remote Aircraft Simulator can
10 also be used to practice a proposed mission. The data communicated to the remote
pilot station can include training and evaluation data for processing and/or display.
This training and evaluation data can include any relevant information, such as flight
path accuracy, etc.

Simulation Network Interface 609 permits participation in a battlefield
15 simulation system such as SIMNET, mixing aircraft, tanks, and ground troops for
training in the coordination of mixed forces. Thus, the system is designed to allow
for the communication of this battlefield simulation information between the remote
aircraft simulator and the remote pilot station. This allows the remote pilot station to
display one or more other simulated entities (e. g., tanks, ground troops, other aircraft,
20 etc.) described by the battlefield simulation information.

The Database

The Digital Database 107 can be comprised of any type of data from which a
three dimensional image can be generated. For example, the U.S. Geological Survey

01492

(USGS) makes available various databases, two of which are of particular interest. The first is the Digital Elevation Model data which consist of an array of regularly spaced terrain elevations.

The other USGS database is the Digital Line Graph data which includes:
5 political and administrative boundaries; hydrography consisting of all flowing water, standing water, and wetlands; major transportation systems consisting of roads and trails, railroads, pipelines, transmission lines, and airports; and significant manmade structures. The Digital Line Graph data is two-dimensional. In the present invention features such as water, roads, railroads, and pipelines are represented as polygons
10 with elevations determined from the Digital Elevation Model data. Transmission lines and significant manmade structures are defined as three-dimensional objects made of polygons and are placed according to the elevations determined from the Digital Elevation Model data. The different types of objects are tagged so that the remote pilot can select them to be highlighted by category or by specific object.

15 Data from additional digital databases can also be incorporated. An example of such a database is from Jeppesen Sanderson whose NavData Services division provides aeronautical charts and makes this information available in digital form.

The procedure for generating the synthesized three-dimensional view from the Digital Database may use any number of techniques, including those disclosed in the
20 1987 patent to Beckwith et al. (U.S. Patent No. 4,660,157 REAL TIME VIDEO PERSPECTIVE DIGITAL MAP DISPLAY METHOD), and the 1993 patent to Dawson et al. (U.S. Patent No. 5,179,638 METHOD AND APPARATUS FOR GENERATING A TEXTURE MAPPED PERSPECTIVE VIEW). One disadvantage

01493

of generating the synthesized three-dimensional view from these elevation databases in real time is the amount of storage space they require. To avoid this large amount of data storage, one embodiment of Digital Database 107 is composed of terrain data that represents the real terrain using polygons. This database may be generated using any number of techniques. For example, this database may be generated by transforming one or more elevation databases into a polygon database using the technique taught in "Pilot Aid Using a Synthetic Environment", serial no. 08/274,394 filed July 11, 1994. Another method for transforming one or more elevation databases into a polygon database is taught in "Digital Map Generator and Display System", serial no. 08/543,590, filed October 16, 1995. An example of a three dimensional projected image created from this database is shown in Fig. 7.

While the invention has been described in terms of several embodiments, those skilled in the art will recognize that the invention is not limited to the embodiments described. The method and apparatus of the invention can be practiced with modification and alteration within the spirit and scope of the appended claims. The description is thus to be regarded as illustrative instead of limiting on the invention.

01494

CLAIMS

What is claimed is:

Sub
P. 1

1. A system comprising:
 - a remotely piloted aircraft;
 - a communications system for communicating flight data between a computer and said remotely piloted aircraft, said flight data including said remotely piloted aircraft's position and orientation, said flight data also including flight control information for controlling said remotely piloted aircraft;
 - a digital database comprising terrain data;
 - said computer to access said terrain data according to said remotely piloted aircraft's position and to transform said terrain data to provide three dimensional projected image data according to said remotely piloted aircraft's orientation;
 - a display for displaying said three dimensional projected image data; and
 - a set of one or more remote flight controls coupled to said computer for inputting said flight control information.

2. The system of claim 1, said remotely piloted aircraft including:
 - a position determining system for locating said remotely piloted aircraft's position in three dimensions; and
 - an orientation determining system for determining said remotely piloted aircraft's orientation in three dimensional space.

01495

25

1 3. The system of claim 1, wherein the flight data communicated between said
2 remotely piloted aircraft and said computer is secured.

1 4. The system of claim 1, wherein said remotely piloted aircraft further comprises
2 a set of one or more video cameras.

1 5. The system of claim 4, wherein said communications system is also for
2 communicating video data representing images captured by said set of one or more
3 video cameras, said video data for displaying said images.

1 6. The system of claim 5, wherein said video data is transmitted on a different
2 communication link than said flight data.

1 7. The system of claim 4, wherein at least one camera in said set of one or more
2 video cameras is an infrared camera.

1 8. The system of claim 1, wherein said display is a head mounted display.

1 9. The system of claim 1, wherein said set of one or more remote flight controls
2 is responsive to manual manipulations.

01496

1 10. The system of claim 1, wherein said computer is also for determining a delay
2 time for communicating said flight data between said computer and said remotely
3 piloted aircraft.

1 11. The system of claim 10, wherein said computer adjusts the sensitivity of said
2 set of one or more remote flight controls based on said delay time.

1 ¹⁰/~~12~~. The system of claim 1, wherein said set of one or more remote flight controls
2 allows for inputting absolute pitch and roll angles instead of pitch and roll rates.

1 ¹¹/~~13~~. The system of claim 1, wherein said computer is also used for correcting
2 adverse yaw without requiring input from said set of one or more remote flight
3 controls.

Sub 1 } 14. A station for flying a remotely piloted aircraft that is real or simulated
B2 } comprising:
3 a database comprising terrain data;
4 a set of remote flight controls for inputting flight control information;
5 a computer having a communications unit configured to receive status
6 information identifying said remotely piloted aircraft's position and orientation in three
7 dimensional space, said computer configured to access said terrain data according to
8 said status information and configured to transform said terrain data to provide three
9 dimensional projected image data representing said remotely piloted aircraft's

01497

10 environment, said computer coupled to said set of remote flight controls and said
11 communications unit for transmitting said flight control information to control said
12 remotely piloted aircraft; and
13 a display configured to display said three dimensional projected image data.

1 ~~15.~~¹⁴ The station of claim ~~15.~~¹³, wherein said communications unit is also configured
2 to receive video data representing images captured by a set of video cameras on said
3 remotely piloted aircraft, said video data for displaying said images.

1 ~~16.~~¹⁵ The station of claim ~~16.~~¹⁴, wherein said video data is transmitted on a different
2 communication link than said flight control information and said status information.

1 ~~17.~~¹⁶ The station of claim ~~17.~~¹³, wherein said display is a head mounted display.

1 ~~18.~~¹⁷ The station of claim ~~18.~~¹³, wherein said set of remote flight controls is
2 responsive to manual manipulations.

1 19. The station of claim 14, wherein said computer is also for determining a delay
2 time for communicating said flight control information between said computer and
3 said remotely piloted aircraft.

1 20. The station of claim 19, wherein said computer adjusts the sensitivity of said
2 set of remote flight controls based on said delay time.

01498

1 ¹⁸~~21~~. The station of claim ¹³~~14~~, wherein said set of remote flight controls are
2 configured to allow inputting absolute pitch and roll angles instead of pitch and roll
3 rates.

1 ¹⁹~~22~~. The station of claim ¹³~~14~~, wherein said computer is also configured to correct
2 adverse yaw without requiring input from said set of remote flight controls.

1 ²⁰~~23~~. The station of claim ¹³~~14~~, wherein said communications unit includes at least
2 one of a communications transceiver and a simulation port.

Sub
1 ~~24~~. A remotely piloted aircraft comprising:
2 a position determining system;
3 an orientation determining system;
4 a communications system for transmitting status information, including said
5 remotely piloted aircraft's position and orientation, to a pilot station for transformation
6 into a three dimensional projected image of said remotely piloted aircraft's
7 environment according to a database representing real terrestrial terrain using
8 polygons, said communications system also for receiving from said pilot station flight
9 control information; and
10 a control system for adjusting said remotely piloted aircraft's flight in response
11 to said flight control information.

01493

1 ~~25. The remotely piloted aircraft of claim 24, wherein said status information and~~
2 ~~said flight control information is communicated between said remotely piloted aircraft~~
3 ~~and said pilot station using a secured communications link.~~

1 26. The remotely piloted aircraft of claim 24, wherein said remotely piloted aircraft
2 further comprises a set of video cameras.

1 27. The remotely piloted aircraft of claim 26, further comprising a video storage
2 unit for storing images captured by said set of video cameras.

1 28. The remotely piloted aircraft of claim 26, wherein said communications system
2 is also for transmitting to said pilot station video data representing images captured by
3 said set of video cameras, said video data for displaying said images.

1 29. The remotely piloted aircraft of claim 28, wherein said video data is
2 transmitted real-time.

1 30. The remotely piloted aircraft of claim 28, wherein said video data is
2 transmitted on a different communication link than said status information.

1 31. The remotely piloted aircraft of claim 28, wherein at least one camera in said
2 set of video cameras is an infrared camera.

01000

1 ~~32. A method for flying a remotely piloted aircraft, said remotely piloted aircraft~~
2 ~~having a current position and a current orientation, said method comprising the steps~~
3 ~~of:~~
4 ~~determining the current position of said remotely piloted aircraft in three~~
5 ~~dimensions;~~
6 ~~determining the current orientation of said remotely piloted aircraft in three~~
7 ~~dimensions;~~
8 ~~communicating said current position and current orientation from said remotely~~
9 ~~piloted aircraft to a pilot station;~~
10 ~~accessing a database comprising terrain data that represents real terrestrial~~
11 ~~terrain as a set of polygons;~~
12 ~~transforming said terrain data into image data representing a simulated three~~
13 ~~dimensional view according to the current position and orientation of said remotely~~
14 ~~piloted aircraft;~~
15 ~~displaying said simulated three dimensional view using said image data; and~~
16 ~~communicating flight control information from said pilot station to said~~
17 ~~remotely piloted aircraft, said remotely piloted aircraft flying in accordance with said~~
18 ~~flight control information.~~

1 33. The method of claim 32, further comprising the steps of:
2 determining a delay time for communicating said flight control information to
3 said remotely piloted aircraft;
4 ~~adjusting said flight control information in response to said delay time~~

01501

1 34. The method of claim 32 further comprising the steps of:
2 generating said flight control information in response to manual manipulations
3 of a set of manual flight controls on said pilot station.

1 35. The method of claim 32 further comprising the steps of:
2 recording images using a set of cameras on said remotely piloted aircraft.

1 36. The method of claim 35 further comprising the steps of:
2 communicating video data representing said images from said remotely piloted
3 aircraft to said pilot station.

1 37. The method of claim 36, wherein said step of communicating video data is
2 performed real-time.

1 38. The method of claim 36, wherein said step of communicating said video data
2 is performed using a different communications link than said flight control
3 information.

1 39. A system comprising:
2 a simulation unit configured to simulate at least a remotely piloted aircraft;
3 a communications system^A configured to communicate flight data between a
4 computer and said simulation unit, said flight data including said remotely piloted

01502

5 aircraft's position and orientation, said flight data also including flight control
6 information for controlling said remotely piloted aircraft;
7 a digital database comprising terrain data;
8 said computer configured to access said terrain data according to said remotely
9 piloted aircraft's position and to transform said terrain data to provide three
10 dimensional projected image data according to said remotely piloted aircraft's
11 orientation;
12 a display configured to display said three dimensional projected image data;
13 and
14 a set of one or more remote flight controls coupled to said computer for
15 inputting said flight control information.

1 40. The system of claim 39, wherein said simulation unit includes a simulation
2 network interface configured to communicate battlefield simulation information with a
3 simulation network, said communications system also configured to communicate said
4 battlefield simulation information between said simulation unit and said computer, said
5 computer also configured to display one or more other simulated entities described by
6 said battlefield simulation information.

1 41. The system of claim 40, wherein said simulation network is SIMNET.

01303

1 42. The system of claim 41, wherein said simulation unit is also configured to
2 communicate to said computer via said communications system training and evaluation
3 information for processing, recording, or display by said computer.

1 43. The system of claim 39, wherein said simulation unit further comprises:
2 a aerodynamic model processor for aiding in simulating said remotely piloted
3 aircraft.

1 44. The system of claim 39, wherein said display is a head mounted display.

1 45. The system of claim 39, wherein said set of one or more remote flight controls
2 is responsive to manual manipulations.

1 46. The system of claim 39, wherein said computer is also for determining a delay
2 time for communicating said flight data between said computer and said remotely
3 piloted aircraft.

1 47. The system of claim 46, wherein said computer adjusts the sensitivity of said
2 set of one or more remote flight controls based on said delay time.

1 48. The system of claim 39, wherein said set of one or more remote flight controls
2 allows for inputting absolute pitch and roll angles instead of pitch and roll rates.

01504

1 49. The system of claim 39 wherein said computer is also used for correcting
2 adverse yaw without requiring input from said set of one or more remote flight
3 controls.

ADD
B4

01505

DECLARATION AND POWER OF ATTORNEY FOR PATENT APPLICATION

As a below named inventor, I hereby declare that:

My residence, post office address and citizenship are as stated below, next to my name.

I believe I am the original, first, and sole inventor (if only one name is listed below) or an original, first, and joint inventor (if plural names are listed below) of the subject matter which is claimed and for which a patent is sought on the invention entitled

A METHOD AND APPARATUS FOR REMOTELY PILOTING AN AIRCRAFT

the specification of which

XXX is attached hereto.
_____ was filed on _____ as
United States Application Number _____
or PCT International Application Number _____
and was amended on _____
(if applicable)

I hereby state that I have reviewed and understand the contents of the above-identified specification, including the claim(s), as amended by any amendment referred to above. I do not know and do not believe that the claimed invention was ever known or used in the United States of America before my invention thereof, or patented or described in any printed publication in any country before my invention thereof or more than one year prior to this application, that the same was not in public use or on sale in the United States of America more than one year prior to this application, and that the invention has not been patented or made the subject of an inventor's certificate issued before the date of this application in any country foreign to the United States of America on an application filed by me or my legal representatives or assigns more than twelve months (for a utility patent application) or six months (for a design patent application) prior to this application.

I acknowledge the duty to disclose all information known to me to be material to patentability as defined in Title 37, Code of Federal Regulations, Section 1.56.

I hereby claim foreign priority benefits under Title 35, United States Code, Section 119(a)-(d), of any foreign application(s) for patent or inventor's certificate listed below and have also identified below any foreign application for patent or inventor's certificate having a filing date before that of the application on which priority is claimed:

<u>Prior Foreign Application(s)</u>			<u>Priority Claimed</u>	
<u>(Number)</u>	<u>(Country)</u>	<u>(Day/Month/Year Filed)</u>	<u>Yes</u>	<u>No</u>
_____	_____	_____	Yes	No
_____	_____	_____	Yes	No
_____	_____	_____	Yes	No

I hereby claim the benefit under title 35, United States Code, Section 119(e) of any United States provisional application(s) listed below

_____	_____
(Application Number)	Filing Date
_____	_____
(Application Number)	Filing Date

01506

I hereby claim the benefit under Title 35, United States Code, Section 120 of any United States application(s) listed below and, insofar as the subject matter of each of the claims of this application is not disclosed in the prior United States application in the manner provided by the first paragraph of Title 35, United States Code, Section 112, I acknowledge the duty to disclose all information known to me to be material to patentability as defined in Title 37, Code of Federal Regulations, Section 1.56 which became available between the filing date of the prior application and the national or PCT international filing date of this application:

(Application Number)	Filing Date	(Status -- patented, pending, abandoned)
(Application Number)	Filing Date	(Status -- patented, pending, abandoned)

40
 I hereby appoint Aloysius T. C. AuYeung, Reg. No. 35,432; William Thomas Babbitt, Reg. No. P39,591; Bradley J. Berezak, Reg. No. 33,474; Michael A. Bernadicou, Reg. No. 35,934; Roger W. Blakely, Jr., Reg. No. 25,831; Thomas M. Coester, Reg. No. P39,637; William Donald Davis, Reg. No. 38,428; Daniel M. De Vos, Reg. 37,813; Karen L. Feisthamel, Reg. No. P40,264; Scot A. Griffin, Reg. No. 38,167; David R. Halvorson, Reg. No. 33,395; Brian Don Hickman, Reg. No. 35,894; Eric Ho, Reg. No. P39,711; George W Hoover II, Reg. No. 32,992; Eric S. Hyman, Reg. No. 30,139; Jeff D. Jacobs, Reg. No. P40,029; Dag H. Johansen, Reg. No. 36,172; Stephen L. King, Reg. No. 19,180; Daniel C. Mallery, Reg. 33,532; Michael J. Mallie, Reg. No. 36,591; Kimberley G. Nobles, Reg. No. 38,255; Ronald W. Reagin, Reg. No. 20,340; James H. Saiter, Reg. No. 35,668; William W. Schaal, Reg. No. P39,018; James C. Scheller, Reg. No. 31,195; Edward W. Scott, IV, Reg. No. 36,000; Maria McCormack Sobrino, Reg. No. 31,639; Stanley W. Sokoloff, Reg. No. 25,128; Allan T. Sponseller, Reg. No. 38,318; Steven R. Sponseller, Reg. No. 39,384; David R. Stevens, Reg. No. 38,626; Edwin H. Taylor, Reg. No. 25,129; Lester J. Vincent, Reg. No. 31,460; John Patrick Ward, Reg. No. P40,216; Ben J. Yorks, Reg. No. 33,609; and Norman Zafman, Reg. No. 26,250; my attorneys; and Roland B. Cortes, Reg. No. 39,152; Gary B. Goates, Reg. No. 35,159; Thomas X. Li, Reg. No. 37,079; and Edwin A. Sloane, Reg. No. 34,728; my patent agents; of BLAKELY, SOKOLOFF, TAYLOR & ZAFMAN, with offices located at 12400 Wilshire Boulevard, 7th Floor, Los Angeles, California 90025, telephone (310) 207-3800, with full power of substitution and revocation, to prosecute this application and to transact all business in the Patent and Trademark Office connected herewith.

I hereby declare that all statements made herein of my own knowledge are true and that all statements made on information and belief are believed to be true; and further that these statements were made with the knowledge that willful false statements and the like so made are punishable by fine or imprisonment, or both, under Section 1001 of Title 18 of the United States Code and that such willful false statements may jeopardize the validity of the application or any patent issued thereon.

100
 Full Name of Sole/First Inventor (given name, family name) Jed Margolin
 Inventor's Signature Jed Margolin Date 1-19-96
 Residence San Jose, California CA (City, State) Citizenship U.S.A. (Country)
 Post Office Address 3570 Pleasant Echo
San Jose, CA 95148
 Full Name of Second/Joint Inventor (given name, family name) _____
 Inventor's Signature _____ Date _____
 Residence _____ (City, State) Citizenship _____ (Country)
 Post Office Address _____

Full Name of Third/Joint Inventor (given name, family name) _____

Inventor's Signature _____ Date _____

Residence _____ Citizenship _____
(City, State) (Country)

Post Office Address _____

Full Name of Fourth/Joint Inventor (given name, family name) _____

Inventor's Signature _____ Date _____

Residence _____ Citizenship _____
(City, State) (Country)

Post Office Address _____

Full Name of Fifth/Joint Inventor (given name, family name) _____

Inventor's Signature _____ Date _____

Residence _____ Citizenship _____
(City, State) (Country)

Post Office Address _____

Full Name of Sixth/Joint Inventor (given name, family name) _____

Inventor's Signature _____ Date _____

Residence _____ Citizenship _____
(City, State) (Country)

Post Office Address _____

Full Name of Seventh/Joint Inventor (given name, family name) _____

Inventor's Signature _____ Date _____

Residence _____ Citizenship _____
(City, State) (Country)

Post Office Address _____

Applicant or Patentee: Jed Margolin Attorney's
Serial or Patent No.: Not Assigned Yes Docket No. 002055.P004
Filed or Issued: January 19, 1996
For: A METHOD AND APPARATUS FOR REMOTELY PILOTING AN AIRCRAFT

VERIFIED STATEMENT (DECLARATION) CLAIMING SMALL ENTITY STATUS
37 CFR 1.9 (f) and 1.27(b) - INDEPENDENT INVENTOR

As the below named inventor, I hereby declare that I qualify as an independent inventor as defined in 37 CFR 1.9(c) for purposes of paying reduced fees under section 41(a) and (b) of Title 35, United States Code, to the Patent and Trademark Office with regard to the invention entitled:

A METHOD AND APPARATUS FOR REMOTELY PILOTING AN AIRCRAFT

described in

- the specification filed herewith.
 application serial no. _____, filed _____
 patent no. _____, issued _____

I have not assigned, granted, conveyed or licensed and am under no obligation under contract or law to assign, grant, convey or license, any rights in the invention to any person who could not be classified as an independent inventor under 37 CFR 1.9(c) if that person had made the invention, or to any concern which would not qualify as a small business concern under 37 CFR 1.9(d) or a nonprofit organization under 37 CFR 1.9(e).

Each person, concern or organization to which I have assigned, granted, conveyed, or licensed or am under an obligation under contract or law to assign, grant, convey or license any rights in the invention is listed below:

- No such person, concern, or organization.
 Persons, concerns, or organizations listed below.*

*NOTE: Separate verified statements are required from each named person, concern or organization having rights to the invention averring to their status as small entities. (37 CFR 1.27)

NAME: Jed Margolin
ADDRESS: 3570 Pleasant Echo, San Jose, California 95148
 Individual Small Business Concern Non-Profit Organization

NAME: _____
ADDRESS: _____
 Individual Small Business Concern Non-Profit Organization

I acknowledge the duty to file, in this application or patent, notification of any change in status resulting in loss of entitlement to small entity status prior to paying, or at the time of paying, the earliest of the issue fee or any maintenance fee due after the date on which status as a small entity is no longer appropriate. (37 CFR 1.28(b))

I hereby declare that all statements made herein of my own knowledge are true and that all statements made on information and belief are believed to be true; and further that these statements were made with the knowledge that willful false statements and the like so made are punishable by fine or imprisonment, or both, under §1001 of Title 18 of the United States Code, and that such willful false statements may jeopardize the validity of the application, any patent issuing thereon, or any patent to which this verified statement is directed.

<u>Jed Margolin</u> NAME OF INVENTOR	_____ NAME OF INVENTOR	_____ NAME OF INVENTOR
<u>Jed Margolin</u> Signature of Inventor	_____ Signature of Inventor	_____ Signature of Inventor
<u>1-19-96</u> DATE	_____ DATE	_____ DATE

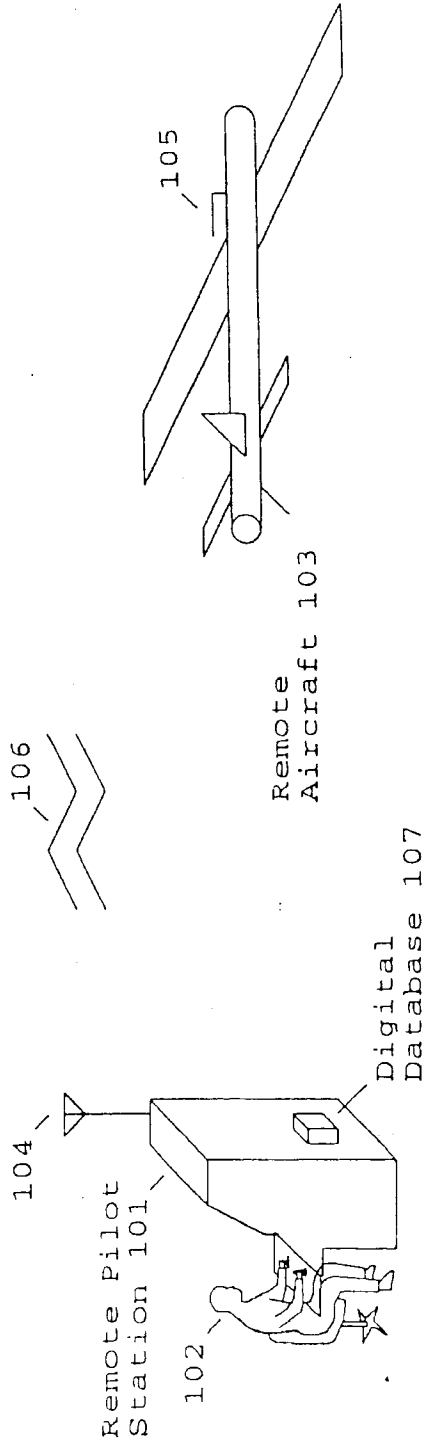

Fig. 1

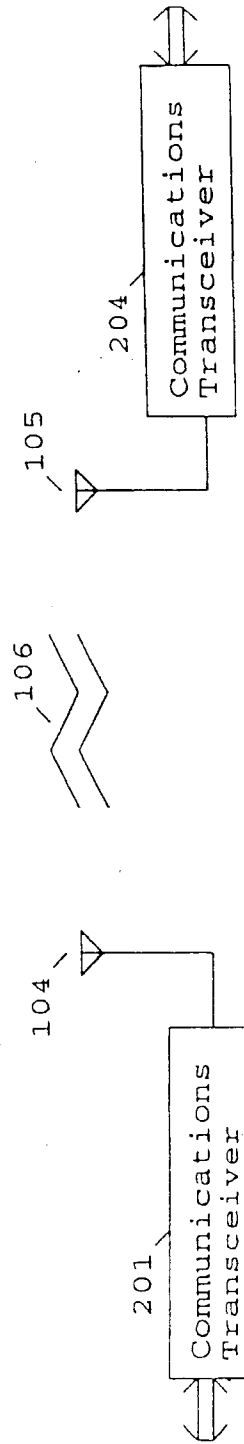

Fig. 2

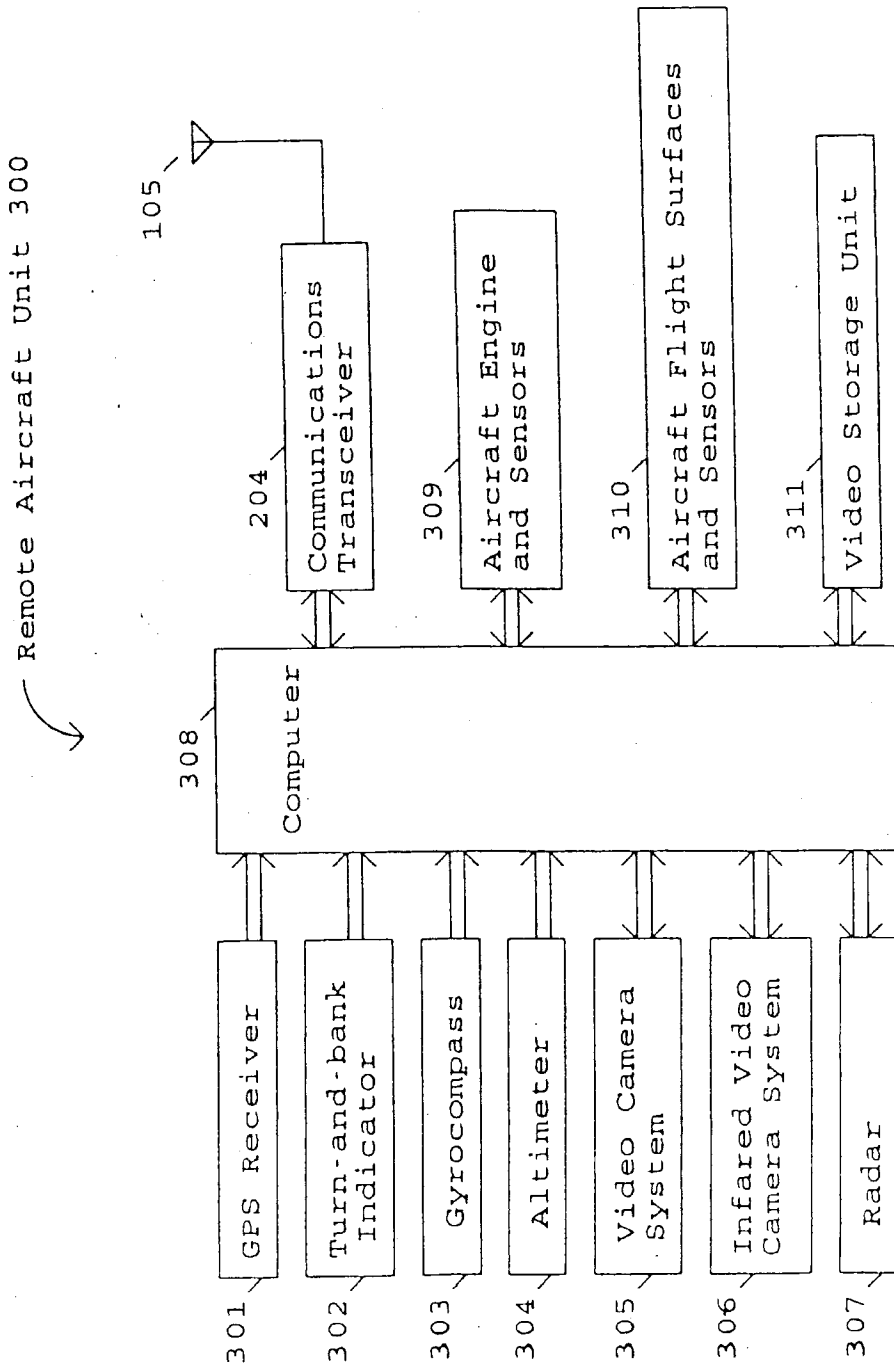

Fig. 3

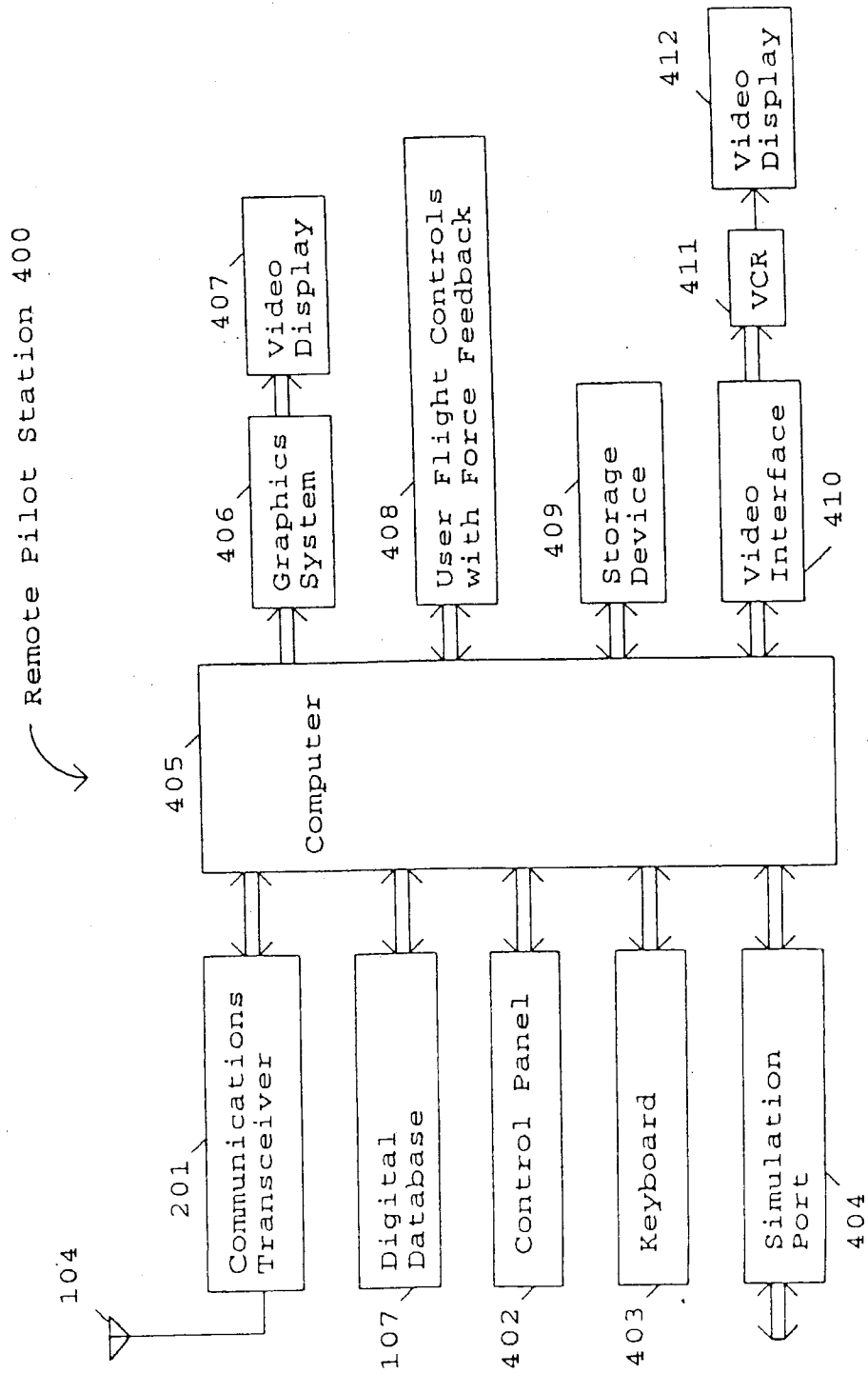

Fig. 4

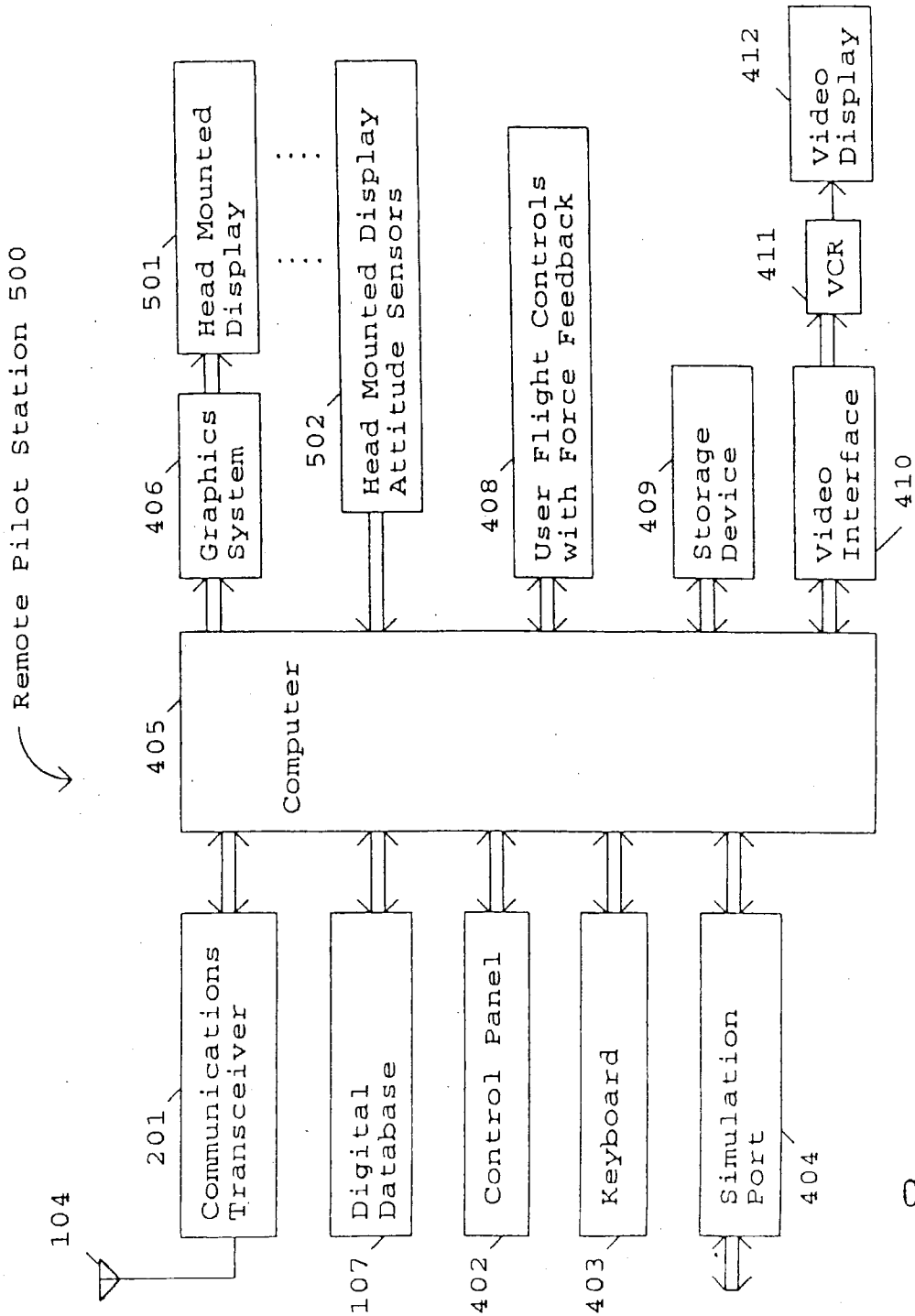

Fig. 5

01514

Remote Aircraft Simulator 600

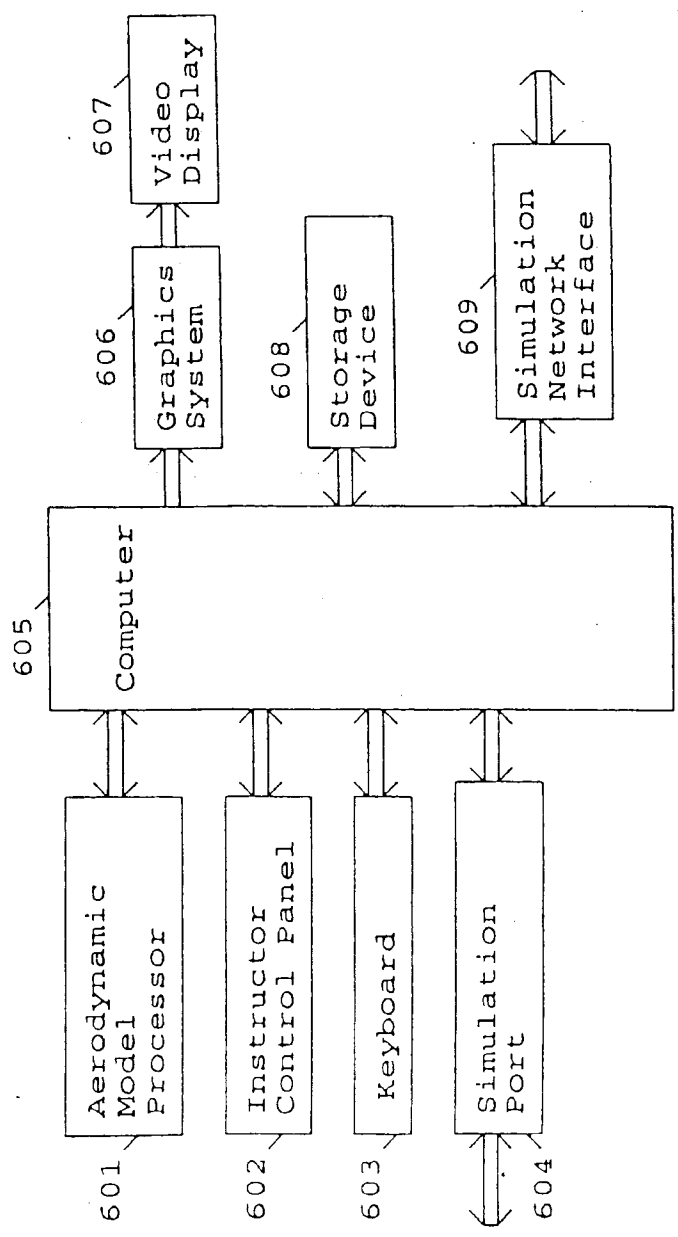

Fig. 6

01515

PRINT OF DRAWINGS
AS ORIGINALLY FILED

02/587731

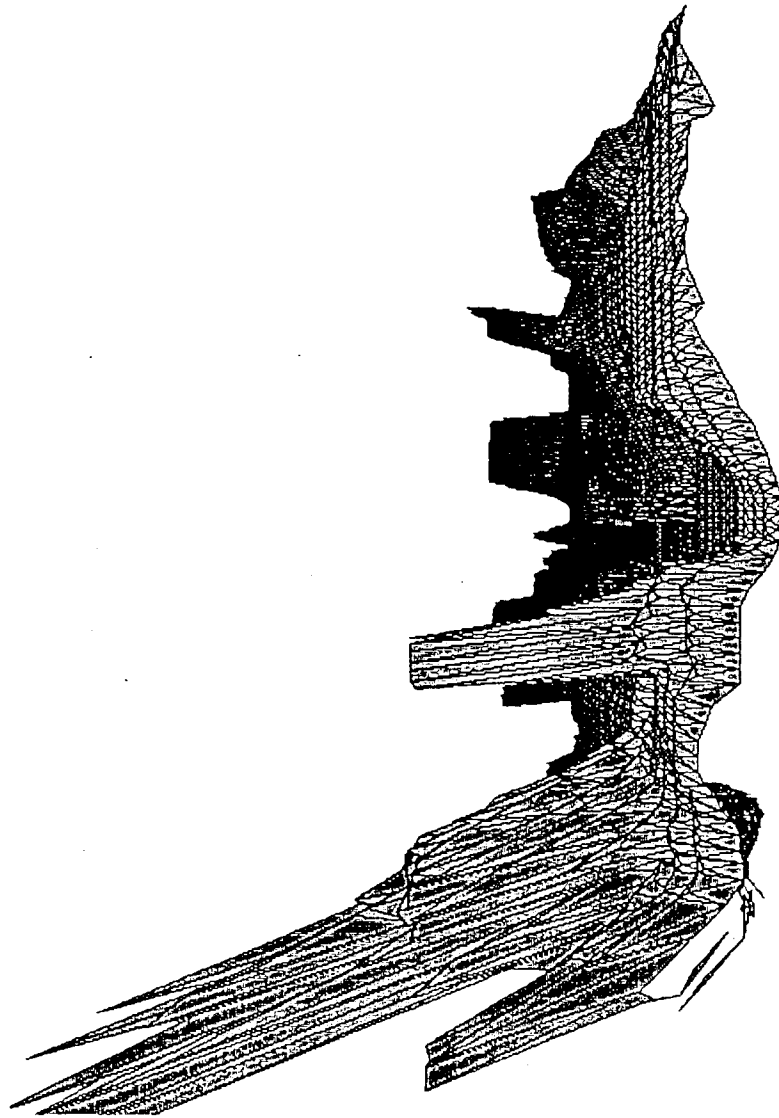

Figure 7

01516

PATENT APPLICATION FEE DETERMINATION RECORD
Effective October 1, 1995

Application or Docket Number

587731

CLAIMS AS FILED - PART I

FOR	(Column 1) NUMBER FILED	(Column 2) NUMBER EXTRA
BASIC FEE		
TOTAL CLAIMS	49 minus 20 =	29
INDEPENDENT CLAIMS	5 minus 3 =	2
MULTIPLE DEPENDENT CLAIM PRESENT		

* If the difference in column 1 is less than zero, enter "0" in column 2

SMALL ENTITY		OR	OTHER THAN SMALL ENTITY	
RATE	FEE		RATE	FEE
	375.00	OR		750.00
x\$11=	319	OR	x\$22=	
x39=	78	OR	x78=	
+125=		OR	+250=	
TOTAL	772	OR	TOTAL	

CLAIMS AS AMENDED - PART II

AMENDMENT A	(Column 1)	(Column 2)	(Column 3)	(Column 4)
	CLAIMS REMAINING AFTER AMENDMENT	HIGHEST NUMBER PREVIOUSLY PAID FOR	PRESENT EXTRA	
Total	38	49	=	11
Independent	4	5	=	1
FIRST PRESENTATION OF MULTIPLE DEPENDENT CLAIM				

SMALL ENTITY		OR	OTHER THAN SMALL ENTITY	
RATE	ADDITIONAL FEE		RATE	ADDITIONAL FEE
x\$11=		OR	x\$22=	
x39=		OR	x78=	
+125=		OR	+250=	
TOTAL ADDIT. FEE		OR	TOTAL ADDIT. FEE	

AMENDMENT B	(Column 1)	(Column 2)	(Column 3)	(Column 4)
	CLAIMS REMAINING AFTER AMENDMENT	HIGHEST NUMBER PREVIOUSLY PAID FOR	PRESENT EXTRA	
Total	38	49	=	11
Independent		5	=	5
FIRST PRESENTATION OF MULTIPLE DEPENDENT CLAIM				

SMALL ENTITY		OR	OTHER THAN SMALL ENTITY	
RATE	ADDITIONAL FEE		RATE	ADDITIONAL FEE
x\$11=		OR	x\$22=	
x39=		OR	x78=	
+125=		OR	+250=	
TOTAL ADDIT. FEE		OR	TOTAL ADDIT. FEE	

AMENDMENT C	(Column 1)	(Column 2)	(Column 3)	(Column 4)
	CLAIMS REMAINING AFTER AMENDMENT	HIGHEST NUMBER PREVIOUSLY PAID FOR	PRESENT EXTRA	
Total	12	20	=	8
Independent	2	3	=	1
FIRST PRESENTATION OF MULTIPLE DEPENDENT CLAIM				

SMALL ENTITY		OR	OTHER THAN SMALL ENTITY	
RATE	ADDITIONAL FEE		RATE	ADDITIONAL FEE
x\$11=		OR	x\$22=	
x39=		OR	x78=	
+125=		OR	+250=	
TOTAL ADDIT. FEE		OR	TOTAL ADDIT. FEE	

* If the entry in column 1 is less than the entry in column 2, write "0" in column 3.
 ** If the "Highest Number Previously Paid For" IN THIS SPACE is less than 20, enter "20."
 *** If the "Highest Number Previously Paid For" IN THIS SPACE is less than 3, enter "3."
 The "Highest Number Previously Paid For" (Total or Independent) is the highest number found in the appropriate box in column 1.

BAR CODE LABEL 		U.S. PATENT APPLICATION			
SERIAL NUMBER 08/587,731		FILING DATE 01/19/96	CLASS 364	GROUP ART UNIT 2304	
APPLICANT	JED MARGOLIN, SAN JOSE, CA. **CONTINUING DATA***** VERIFIED <hr/>				
	FOREIGN/PCT APPLICATIONS*** VERIFIED <hr/>				
***** SMALL ENTITY *****					
STATE OR COUNTRY CA	SHEETS DRAWING 7	TOTAL CLAIMS 49	INDEPENDENT CLAIMS 5	FILING FEE RECEIVED \$772.00	ATTORNEY DOCKET NO. 002055.P004
ADDRESS	BLAKELY SOKOLOFF TAYLOR AND ZAFMAN 12400 WILSHIRE BOULEVARD 7TH FLOOR LOS ANGELES CA 90025				
	TITLE METHOD AND APPARATUS FOR REMOTELY PILOTING AN AIRCRAFT				
This is to certify that annexed hereto is a true copy from the records of the United States Patent and Trademark Office of the application which is identified above. By authority of the COMMISSIONER OF PATENTS AND TRADEMARKS					
Date	Certifying Officer				01520

02/587731

Patent

Attorney's Docket No. 02055.P004

THE COMMISSIONER OF PATENTS AND TRADEMARKS
Washington, D.C. 20231

SIR: Transmitted herewith for filing is the **nonprovisional patent application** of

Inventor(s): Jed Margolin

For: A METHOD AND APPARATUS FOR REMOTELY PILOTING AN AIRCRAFT

(Title)

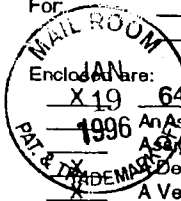

Enclosed are: X 19 64 sheet(s) of Drawings.

1996 An Assignment of the invention to
Assignment Cover Sheet Form PTO-1595.

X Declaration and Power of Attorney (XXX signed/ _____ unsigned).

X A Verified Statement to establish Small Entity Status under 37 C.F.R. §§ 1.9 and 1.27.

X Information Disclosure Statement and PTO Form 1449 with (16) references attached

The Filing Fee has been calculated as shown below:

	(Col. 1)		(Col. 2)		SMALL ENTITY		OTHER THAN A SMALL ENTITY	
For:	No. Filed		No. Extra		Rate	Fee	Rate	Fee
Basic Fee:						\$ 375		\$ 750
Total Claims:	49	- 20 *	29		x 11	\$ 319	x 22	\$
Indep. Claims:	5	- 3 *	2		x 39	\$ 78	x 78	\$
<input type="checkbox"/> Multiple Dependent Claim(s) Presented					+ 125	\$	+ 250	\$
					TOTAL	\$ 772	TOTAL	\$

* If the difference is less than zero, enter "0" in Col. 2.

- A check for \$ 772.00 for the filing fee is enclosed.
- A check for \$ 40.00 for recordation of the Assignment is enclosed.
- The Commissioner is hereby authorized to charge payment of the following fees associated with this communication, or credit any overpayment, to our Deposit Account No. 02-2666. **A duplicate copy of this sheet is enclosed.**
 - Any additional filing fees required under 37 C.F.R. § 1.16.
 - Any patent application processing fees under 37 C.F.R. § 1.17.
- The Commissioner is hereby authorized to charge payment of the following fees during the pendency of this application, or credit any overpayment, to our Deposit Account No. 02-2666. **A duplicate copy of this sheet is enclosed.**
 - Any processing fees under 37 C.F.R. § 1.17, including any extension fees.
 - Any filing fees under 37 C.F.R. § 1.16 for presentation of extra claims.
- Send all correspondence to the undersigned at BLAKELY, SOKOLOFF, TAYLOR & ZAFMAN, 12400 Wilshire Boulevard, Seventh Floor, Los Angeles, California 90025, and direct all telephone calls to the undersigned at (408) 720-8598.

Respectfully submitted,
BLAKELY SOKOLOFF TAYLOR & ZAFMAN

By [Signature]
Daniel M. De Vos

Reg. No.: 37,813

Date: 1/19/96

12400 Wilshire Boulevard
Seventh Floor
Los Angeles, California 90025
(408) 720-8598

(LJV/cak 10/02/95)

Express Mail mailing label number EM291965992US

Date of Deposit January 19, 1996

I hereby certify that this paper or fee is being deposited with the United States Postal Service "Express Mail Post Office to Addressee" service under 37 CFR 1.10 on the date indicated above and is addressed to the Commissioner of Patents and Trademarks, Washington, D.C. 20231.

Dukle G. Stinson

(Typed or printed name of person mailing paper or fee)

[Signature]

(Signature of person mailing paper or fee)

01521

08/587731

002055.P004

IN THE UNITED STATES PATENT AND TRADEMARK OFFICE



#2
DC
4/15/96

In re Application of:)	Examiner:	Not Yet Assigned
Jed Margolin)	Art Unit:	Not Yet Assigned
Serial No.: NOT ASSIGNED YET)		
Filed: Not Yet Assigned)		
For: A METHOD AND APPARATUS FOR REMOTELY PILOTING AN AIRCRAFT)		

INFORMATION DISCLOSURE STATEMENT

Honorable Commissioner of
Patents and Trademarks
Washington, D.C. 20231

Sir,

Applicant hereby requests consideration of the enclosed Information Disclosure Statement pursuant to 37 C.F.R. §1.97(b)(3). Attached hereto is PTO Form 1449 along with a copy of the cited reference. If any additional fee is required, please charge Deposit Account No. 02-2666. A duplicate of this Petition is enclosed for deposit account charging purposes.

Respectfully submitted,

BLAKELY, SOKOLOFF, TAYLOR & ZAFMAN

Daniel M. De Vos
Reg. No. 37,813

Dated: 1/19, 1996

12400 Wilshire Boulevard
Seventh Floor
Los Angeles, CA 90025-1026
(408) 720-8598

FIRST CLASS CERTIFICATE OF MAILING
(37 C.F.R. § 1.8(a))

I hereby certify that this correspondence is being deposited with the United States Postal Service as first class mail with sufficient postage in an envelope addressed to the Commissioner of Patents and Trademarks, Washington, D.C. 20231

on January 19, 1996.
Date of Deposit

Dulcie G. Stinson

Name of Person Mailing Correspondence

Dulcie G. Stinson
Signature

January 19, 1996
Date

0152Z

Form PTO-1449 (REV. 8-83) U.S. DEPARTMENT OF COMMERCE PATENT AND TRADEMARK OFFICE

ATTY. DOCKET NO. 002055.P004 SERIAL NO. 08/587,731 Not Yet Assigned

APPLICANT: Jed Margolin

FILING DATE: 01/19/96 GROUP: 2364 Not Yet Assigned



INFORMATION DISCLOSURE CITATION (Use several sheets if necessary)

U.S. PATENT DOCUMENTS

EXAMINER INITIAL	DOCUMENT NUMBER	DATE	NAME	CLASS	SUBCLASS	FILING DATE IF APPROPRIATE
TN	3795909	03-05-74	Vehrs, Jr.	343	7	10-12-71
TN	4467429	08-21-84	Kendig	343	433	01-13-82
TN	4739327	04-19-88	Konig et al.	342	26	03-24-86
TN	4760396	07-26-88	Barney et al.	342	65	07-11-86
TN	5086396	02-04-92	Waruszewski, Jr.	364	454	02-19-91
TN	5257347	10-26-93	Busbridge et al.	395	129	06-06-91
TN	5272639	12-21-93	McGuffin	364	449	01-14-92
TN	5335181	08-02-94	McGuffin	364	443	01-15-92
TN	5406286	04-11-95	Tran et al.	342	13	11-17-92
TN	5446666	08-29-95	Bauer	364	434	05-17-94
TN	4405943	11-20-83	Kanaly	358	133	08-19-81

FOREIGN PATENT DOCUMENTS

EXAMINER INITIAL	DOCUMENT NUMBER	DATE	COUNTRY	CLASS	SUBCLASS	TRANSLATION	
						YES	NO

OTHER DOCUMENTS (Including Author, Title, Date, Pertinent Pages, Etc.)

TN	Lyons, J.W., "Some Navigational Concepts for Remotely Piloted Vehicles", AGARD Conference Proceed. n.176, Med. Accur. Low Cost Navig. at Avignon, Panel Tec. Meeting, 5-1-5-15, (1976)
TN	"US GeoData Digital Line Graphs", U.S. Dept. of the Interior, U.S. Geolo. Surv. Earth Sci. Info Ctr. (Factsheet) (1993) June 1993.
TN	"US GeoData Digital Elevation Models", U.S. Dept. of the Interior, U.S. Geolo. Surv. Earth Sci. Info Ctr. (Factsheet) (1993) June 1993.

EXAMINER: Jan Nguyen DATE CONSIDERED: 07/15/1997

*EXAMINER: Initial if citation considered, whether or not citation is in conformance with MP&P 609; Draw line through citation if not in conformance and not considered. Include copy of this form with next communication to applicant.

①

Lyons -

00596166 E.I. Monthly No: EI7701002230 E.I. Yearly No: EI77029141
 Title: REPORT ON THE BOEING FLEET LOCATION AND INFORMATION REPORTING SYSTEM (FLAIR).
 Author: Lewis, R. W.; Lezniak, T. W.
 Corporate Source: Boeing Co, Wichita, Kans
 Source: Kentucky University, Office of Research and Engineering Services, Bulletin n 110 May 1976 Carnahan Conf on Crime Countermeas, Proc, Univ of Ky, Lexington, May 5-7 1976 p 73-85
 Publication Year: 1976
 CODEN: KUOBAJ ISSN: 0434-8566
 Language: ENGLISH

620 A072KE

00619069 E.I. Monthly No: EI7704021261 E.I. Yearly No: EI77003363
 Title: SOME NAVIGATIONAL CONCEPTS FOR REMOTELY PILOTED VEHICLES.
 Author: Lyons, J. W.; Bannister, J. D.; Brown, J. G.
 Corporate Source: Hawker Siddeley Aviat Ltd, Brough, North Humberside, Engl
 Source: AGARD Conference Proceedings n 176 Aug 1976 Medium Accuracy Low Cost Navig at Avionics Panel Tech Meet, Sandfjord, Norw, Sep 9-12 1975 Pap 15 p
 Publication Year: 1976
 CODEN: AGCPAY ISSN: 0549-7191
 Language: ENGLISH

629.13 A063AY

00617112 E.I. Monthly No: EI7704021735 E.I. Yearly No: EI77001913
 Title: OPTIMALLY INTEGRATED PROJECTED MAP NAVIGATION SYSTEM.
 Author: Reid, D. B.; Harman, R. K.; Frame, D. J.
 Corporate Source: Comput Devices Co, Ottawa, Ont
 Source: AGARD Conference Proceedings n 176 Aug 1976 Medium Accuracy Low Cost Navig at Avionics Panel Tech Meet, Sandfjord, Norw, Sep 8-12 1975 Pap 28, 31 p
 Publication Year: 1976
 CODEN: AGCPAY ISSN: 0549-7191
 Language: ENGLISH

629.13 A063AY

①
 *A
 call

54

SOME NAVIGATIONAL CONCEPTS FOR REMOTELY PILOTED VEHICLES

J. W. Lyons, J. D. Bannister, J. G. Brown.
Hawker Siddeley Aviation Ltd.
Brough,
North Humberside,
United Kingdom.

ABSTRACT

This paper discusses methods by which the navigation function for Remotely Piloted Vehicles (RPVs) can be achieved without the need for complex specialised navigation equipment. The objective is to make use of equipment normally carried for RPV operation to supplement a simple dead reckoning navigation system. In this way significant improvements in navigation capability can be achieved with little or no added complexity in the vehicle itself. The additional processing is carried out at the control centre where restrictions on equipment size and cost are not so prohibitive. Both a two-way data link and a forward looking electro-optical sensor are highly desirable RPV facilities and these are on-board equipments that can be adapted to provide additional information at the ground-based or airborne control station for vehicle position updating.

The paper discusses techniques varying from the use of the data link to provide range-bearing navigation to map matching using reconnaissance sensors or a forward looking sensor picture. Use can also be made of an on-board laser to provide range-to-terrain measurements which, when correlated with a computer stored map, enables the RPV position to be continuously updated. Results of simulation studies which have been carried out to validate the techniques and provide an estimate of the accuracies that may be achieved are presented.

NOMENCLATURE

ϵ_{RPV}	=	Position error of RPV
σ_R	=	Range error of DME system
σ_θ	=	Bearing error of Data Link
R	=	Range of RPV from relay aircraft
ϵ_A	=	Navigation error of control or relay vehicle
R_n	=	Range of RPV at the nth sample
θ_n	=	Azimuth angle of RPV at the nth sample
Δt	=	Time between data samples
V_2	=	Velocity of relay vehicle
ψ	=	Heading of RPV
R_c	=	Range of RPV from the bisector of the relay station base line
ψ_c	=	Bearing of RPV from the bisector of the relay station base line
D	=	Distance between the relay stations forming the base line
R_{ID}	=	Range from RPV to Identification Point
h	=	Height of RPV above Identification Point
θ_{ID}	=	Downlook angle from RPV to Identification Point
θ_L	=	Laser depression angle
β_1	=	Laser azimuth angle
R_{H1}	=	Horizontal range from RPV to laser/terrain intersection point
Δh_1	=	Height difference between terrain at RPV and at Laser/terrain intersection point
ϵ_1	=	Error in actual/predicted terrain height

1. INTRODUCTION

In recent years the ever increasing cost and complexity of manned aircraft for operation in a battlefield environment has led to a re-appraisal of the use of Remotely Piloted Vehicles (RPVs) for certain types of missions. For high attrition situations in which aircrew are at risk the use of expendable or limited life vehicles is advantageous. Provided the vehicle controllers are equipped with the necessary guidance and control information, the RPV can possess an operational flexibility comparable with that of a manned aircraft. The roles most suited to a battlefield RPV are:

- (i) Target Marking
- (ii) Reconnaissance
- (iii) ECM

The penetration of the RPV beyond the Forward Edge of the Battle Area (FEBA) necessitates the use of a relay station located such that its altitude is adequate to maintain radio contact with the RPV while

its position is such as to be out of range of SAMs. The relay may be either a stationary platform or a patrolling aircraft. In the latter case, the controller can be located in the aircraft. More usual is the use of a ground control station.

The RPV should be as small as possible compatible with the above mission tasks and this means restricting the complexity of the onboard avionics. Although equipment such as forward looking and reconnaissance sensors, a data link and possibly a laser are of necessity located on the vehicle, the navigation and guidance equipment can be largely accommodated on the relay vehicle or at the ground station. The sensors already on board the RPV can be used to provide a navigational facility which can supplement a simple modest accuracy system such as a compass/air data unit. The basic airborne system would provide sufficient information for general flying of the RPV, i.e. heading, velocity and a rough measure of position, while the additional sensors can be used to provide an accurate measure of present RPV position. This philosophy is adopted here and the paper presents a number of alternative techniques whereby, depending on the particular situation, one or more of the above items form part of the overall navigation system.

Firstly, the data link is required to maintain a constant or regular periodic contact with the RPV by means of a narrow beam - width microwave link, hence a tracking facility must already exist on the relay vehicle providing RPV bearing information. Range information can be provided by means of a responsive transponder similar to an IFF system utilizing the same vehicle antennas.

Secondly, update facilities can be provided by means of either a real time forward looking or vertical reconnaissance image used in conjunction with a moving map display.

A third possibility makes use of the ranging laser used for target marking purposes. En route to and from the target area, range-to-terrain measurements can be transmitted over the data link to the control station. This data can then be correlated with a computer stored map to determine the most likely RPV position.

The adoption of one or more of the above techniques leads to a significant improvement in navigational accuracy with little or no additional complexity in the vehicle itself.

2. RADIO NAVIGATION USING A DATA LINK

The data link forms the life line of communication between the RPV and the control station. It is the means by which guidance signals to the RPV are transmitted and video signals received. Because of the need for wideband transmissions of video signals (typically 5 MHz) and the desirability of narrow beam - width, low side-lobe antennas for good anti-jamming capability, microwave frequencies are generally employed. This limits RPV operation to line of sight communication and hence may necessitate the use of airborne relay stations. A possible operational situation is shown in Fig. 1. In practice there may well be more than one relay station and RPV. It is envisaged that the relay station will stand back from the FEM, out of direct range of ground-to-air weapons. This does not however prevent the enemy making use of either ground or airborne jammers to illuminate the relay vehicle, thereby reducing the effective signal-to-noise ratio of the signals received from the RPV. Two situations can be distinguished, one in which the relative relay - RPV geometry is such that the jamming signals are received by the relay antenna mainlobe, in which case the signal-to-noise ratio is low. The second situation relates more to large lateral separations of jammers and the RPV in which case jamming signals enter the relay antenna via the side-lobes. In such cases, the signal-to-noise ratio may not be significantly degraded and unimpaired operations can continue.

When the effects of enemy ECM can be neglected, i.e. the relay station remaining in contact with the RPV, angular information is directly available from the data link antenna and range can be derived using conventional DME techniques. Thus the position of the RPV relative to the relay station can be reasonably well defined. For absolute location of the RPV, clearly the position of the relay vehicle needs to be defined. In the case of tethered platforms this is no problem but for patrolling aircraft or hovering vehicles the error of the relay vehicle navigation system has also to be taken into account. An overall error can be estimated from the following equation.

$$\sigma_{RPV} = (\sigma_R^2 + \sigma_A^2 + R^2 \sigma_\psi^2)^{1/2} \quad (1)$$

Typical results are presented in Fig. 2.

Perhaps of more importance is the dynamic problem of guiding the RPV to a given position. For this case it is desirable to have a good knowledge of the RPV heading and velocity as well as its present position and best results are obtained by using both on-board and remote guidance equipment. For example, estimates of heading and velocity provided by the compass/air data system can be compared with time dependent range and bearing data derived from the data link to obtain improved estimates of RPV position, velocity and heading. Figure 3 shows the geometry relevant to a 3 point moving window tracking technique. The heading of the RPV can be written in functional form as

$$\theta = f(R_{n-1, n, n-1}, \psi_{n-1, n, n-1}, \Delta T, V_R) \quad (2)$$

This generally requires more processing effort than the determination of range or velocity. For tethered or hovering relay vehicles V_R is clearly zero in the above equation. Since the on-board and remote systems use independent data the results are best combined using a statistical filter. The simplest approach is to use a least squares technique (see Reference 1). Alternatively, an integrated filtering method as described in Reference 2 may be employed. This latter paper suggests a significant improvement in navigational accuracies by employing filtering techniques.

In ECM environments, range information to the RPV cannot be guaranteed though it is likely that bearing information can still be derived. To estimate the RPV position in such circumstances, use can be made of the possible multiplicity of relay stations. From known locations of the relay vehicles, cross bearing fixes on the RPV of interest can be achieved. This is a well known location technique, both for air and marine applications. A detailed analysis of the method is given in Reference 3. For the present

analysis a more useful expression for position accuracy is

$$\sigma_{pp}^2 = \sigma_{p0}^2 \left[\frac{Rc^2 + D^2}{R^2} \right] + \left[\frac{Rc^2 + D^2}{R^2} \right] - (RcD \sin \theta c)^2 \tag{3}$$

RD cos θ c

Results derived from equation 3 are plotted in Fig. 4. It can be shown from the above expression that the best accuracy is achieved when θ c = 0 and Rc/D = 0.3536. Thus for good accuracy using this technique, the separation between the relay stations should be large compared with the penetration of the RFV beyond the FEBA. To determine the overall RPV position, the additional effect of relay station position accuracy must also be taken into account.

3. MAP MATCHING

So far we have considered on-board dead reckoning and remote radio navigation techniques. The main problem with these techniques is that the position accuracy is either time or range dependent and so additional methods of updating vehicle positions are necessary. A number of techniques are available for an RFV. For reconnaissance vehicles having real time sensors, the problem is relatively straight-forward. The use of either Side Looking Radar (SLR) or Infra Red Line Scan (IRLS) systems means that effectively a map is generated while the sensor is operating. The resulting video signal transmitted to the control station thus provides a method whereby the RPV position can be readily located.

One system widely employed for displaying aircraft navigational information is the projected moving map display and a similar technique can be employed by the RPV control station. Current map systems have the additional facility of being able to combine an electronic display with the moving map and Reference 4 discusses some of the latest developments in this field. Making use of this principle, it may be possible to project the sensor image onto the map and determine the RPV position by matching the two images. Fig. 5 shows the principles of the combined map/sensor display projection system.

In practice it is envisaged that the RPV reconnaissance sensor image will be monitored on a TV display. The use of digital scan converters allows a number of alternative display presentations (see Reference 5). Perhaps the most convenient display mode for the present application is the rolling map or "massing scene" technique where a new line is added to the top of the display and the scene is shifted slowly downwards.

When likely update features are seen (e.g. rivers, crossroads, distinctive man made objects) the frame is frozen, a transfer button is initiated and the digitally stored frame is projected via the map system. The map is then moved laterally to align with the projected image. When the alignment is judged adequate an accept button is pressed and the present position co-ordinates of the RPV updated, taking into account the elapsed time for updating actions. A possible arrangement of operator console is shown in Fig. 6. Control of the image pictures and map matching facility is achieved through the use of a joystick control. Some simulated results of this update technique are shown in Fig. 7. These results make use of SLR imagery.

When the RPV has only real time forward-looking sensors, use can still be made of the transmitted image to provide a navigational update facility. However, in order to create the correct perspective map-like projection, appropriate transformation of the image is necessary. In photogrammetrical language this is termed rectification though the appropriate term in perspective art is anamorphic projection. The principle involved is shown in Fig. 8. The received forward looking image may be co-ordinate transformed either by optical techniques utilizing anamorphic lens systems or electronically by means of the scan converter or projection CRT sweep circuitry. Since the image already exists in electrical form, the electronic transformation techniques are probably most suitable. The map type image projected onto the display is now trapezoidal in shape because of the transformation. Major features on the map can again be aligned as described above. In practice several factors combine to make the task more difficult than for the vertical sensor case :-

- i) varying resolution, contrast and intensity across the display.
- ii) distortion due to undulation of the terrain.
- iii) the wildly exaggerated size of trees, hedges, buildings etc.

Hence an alternative simpler update technique is proposed for this situation.

With a forward looking sensor display it is possible to mark objects electronically with a joystick controlled marker symbol; this is standard HUD technology. The electronics can be arranged such that having frozen a suitable image and marked an identifiable point on it, a marker symbol appears on the projected map. Also the field-of-view of the sensor, as projected in the horizontal plane, is superimposed on the map as a "bright up" presentation so that the orientation of the sensor view is clearly seen. The same joystick is now used to align the map with the marker. To ensure correct alignment at least two identification points (IPs) are required on any given image, preferably three or four. In a conventional airborne situation the task of marking a target on a display is not easy and may take several seconds. For the situation described above, however, the problem is one of marking chosen objects on a frozen image in a shirt sleeve environment and hence this aspect of the navigation problem is not considered too difficult.

Fig. 9 shows some simulated results of the above update technique. The effect of the bright area is clearly seen in relation to the marked targets.

4. TERRAIN MAP CORRELATION

Reconnaissance or forward looking sensors provide a convenient method of updating the navigation system. However, these sensors require a large data link bandwidth to transmit the video pictures to the control centre and hence are vulnerable to ECM. Reduction of the video bandwidth reduces the effect of ECM but with a consequent degradation of picture resolution. Hence an alternative method of updating the navigation system is desirable. The method to be described uses ranging measurements made by the

Laser and compares these with corresponding ranges obtained from a representation of the terrain stored in a computer at the control centre. The data link bandwidth required to transmit the Laser ranges is very small and hence is correspondingly less susceptible to interference by ECM.

Basically the technique depends on an adequate representation of the terrain over which it is intended to fly the RPV. The terrain is stored as a series of height ordinates obtained from a map of the relevant area and these are used to construct a computer model of the terrain (Fig. 10). The initial effort in producing this data base from the map is considerable but for a given area it is a 'once-only' task. A simulation of the RPV flight path at the control centre then allows Laser range to be calculated for each RPV position and a comparison made with actual ranging measurements. A series of positions and headings around the expected values (and limited in deviation from these expected values by estimated navigation errors) are also tested against the actual measurements and the best position and heading for the RPV found.

For a 2-D simulation, where it is only necessary to determine the along-track position of the RPV, it has been found that a minimum of three measurements (2 laser - altimeter) are necessary to give a reliable indication of position, while for a 3-D simulation at least four measurements (3 laser - altimeter) are required. These conclusions are based on error-free simulations. However, when errors are taken into account it has been found necessary to considerably increase the number of measurements to effectively smooth out the errors. Apart from the errors involved in the actual Laser measurements the accuracy of terrain representation has a considerable influence on the feasibility of the method. In addition, the technique is ineffective over the sea or over flat, featureless terrain. Nevertheless, by combining this method with those described previously, an effective navigation system is offered without the necessity for specialised navigation equipment.

The method has been demonstrated using a computer simulation of both the Laser range measurement and range matching processes, bearing in mind that the latter should not simply be a reversal of the former as this would neglect the "real world" errors caused by imperfect representation of the terrain. The simulation of the matching process is precisely the process that is required to be carried out at the control centre, while the simulation of the Laser measurement is an attempt to predict the results of actual measurements made from the vehicle during flight. Hence careful representation of the terrain has been used for measurement simulation with terrain data points spaced 100m apart on a rectangular grid.

The range as seen by the laser is calculated by taking a section through the terrain in the direction in which the laser is pointing. Assuming a knowledge of the RPV height above the terrain h (from a radio altimeter) and the Laser beam depression angle β_0 , the horizontal range RH and incremental height ΔH of the laser/terrain intersection point Z , relative to the RPV position X , can be calculated (Fig. 11). The following data is then transmitted from the RPV to the control centre :-

- | | | |
|------|----------------------|--|
| i) | height differences | $\Delta H_1 \dots \Delta H_2 \dots \Delta H_n$ |
| ii) | horizontal ranges | $RH_1 \dots RH_2 \dots RH_n$ |
| iii) | Laser azimuth angles | $\beta_1 \dots \beta_2 \dots \beta_n$ |

From a knowledge of RPV velocity and heading and an estimate of likely navigation errors, the current RPV position can be predicted together with a circle of possible error (Fig. 12). A search can therefore be made within this circle to determine the most likely RPV position. For each position considered, the terrain height H is known from the model and at range RH_i and bearing β_i from that position the expected terrain height is given by $H = \Delta H_i$. This is compared with the actual terrain height at that point (as stored by the model) to give an error ϵ_i . By considering each RH_i and β_i ($i = 1$ to n) an RMS error is obtained for each position, and the position with minimum error gives the most likely RPV position.

5. NAVIGATION ACCURACIES

In this section of the paper an attempt will be made to compare the navigation accuracies attainable from the various techniques previously discussed.

For the basic on-board system comprising a magnetic compass and air data unit, the following accuracies are predicted based on currently available equipment :-

heading	1° standard deviation
velocity	2% standard deviation

This gives a position accuracy of approximately 2% distance gone. However, a major source of error will be due to wind; although a correction can be applied, an uncertainty in wind speed of the order of 5 m/s is not unreasonable. Assuming an RPV velocity 200 m/s this represents 2½% giving a resultant position accuracy of the order of 3½% distance gone.

Range-bearing techniques have been used for many years as exemplified by TACAN/DME navigation. When using ground beacons a major source of error is multipath propagation which gives rise to large errors in estimating the bearing to a station. However the modern systems which use airborne beacons overcome this problem. This is the situation which exists when considering RPVs.

Clearly target bearing estimation from the relay vehicle is a major contributor to RPV location accuracy. Since microwave frequencies, perhaps at X-band, coupled with monopulse determination techniques are employed in the relay vehicle, good angular estimates of the RPV bearing are available. Final figures are dependent on antenna size, frequency of operation and signal-to-noise ratio. It is considered that at least 1° standard deviation should be readily attainable in a practical system. From Fig. 2 it is seen that this gives a typical RPV position error better than 2 km standard deviation at 100 km range. The ultimate short range accuracy is clearly dependent on the accuracy of the relay vehicle navigation system.

When jamming environments are such that perhaps only bearing information is available to the relay vehicles, the cross bearing fix principle utilising multiple relay vehicles remains a possibility for RPV position fixing. Fig. 4 shows the accuracy function on a relative scale and clearly indicates the position dependent accuracy effect. To utilise this technique successfully in a practical situation, it is necessary to carefully select the patrol station positions for the relay vehicles relative to the battlefield.

Taking the 50% accuracy contour as a guide to the area of utility of the technique, this corresponds to a distance from the baseline bi-sector roughly equal to the relay station separation. If we therefore envisage RPV operations out to 100 km from the relay, the relay stations should be located 100 km from each other. At this separation, with a bearing accuracy estimation of 1° standard deviation the RPV can be located to a maximum accuracy of 1.5 km standard deviation. Combining this with a typical relay vehicle position accuracy of 0.5 km raises this figure by less than 0.1 km.

Navigation updating using a real time picture from a vertical reconnaissance sensor provides a very accurate means of position fixing. Fig. 7 shows some simulated results based on SL2 imagery. The picture quality of these radars is seen to be more than adequate to identify the main geographical terrain and man made features. In the example shown, the river bank provides a good map matching feature. Fig. 7a shows some degree of misalignment of the map and radar image. In Fig. 7b the two are aligned. Some errors are present due to the scale compression effect at ranges close to the RPV and this is reflected in map projection distortion. Even without further video processing to correct this effect, it is considered that a location accuracy of 0.2 km is attainable.

When using a forward looking sensor for map matching the useful range of the sensor is limited to ~ 3 km, hence the matching will be done over a small area and a larger scale map can be used (cf Figs. 7 and 9). This, together with the fact that considerable detail will be visible in the foreground of the display, makes the matching task easier allowing a match to within say 100 m. Unfortunately various system errors can produce incorrect transformation of the display and result in significant position errors. The sources of error and their effects are the same irrespective of whether a full display transformation technique is being used or only marked identification points.

Across track errors should be small since the only error is that due to marking the display in azimuth. Display marking should be possible to within ~ 2% full scale, allowing for both operator and marker system errors. For a 30° FOV sensor this corresponds to an angular error of 10 m rads. Display points of interest are expected to be at ranges between 1 and 2 km and for accurate across track matching a near and a far point should be chosen. This will give sensor heading to within 50 m rads and across track errors < 40 m, i.e. the matching is the biggest source of error.

Along track errors can be much greater. The range to an identification point is given by

$$R_{IP} = \frac{h}{\tan(\theta_{IP})}$$

where h is the height of the RPV above the IP
 θ_{IP} is the downlook angle from RPV to the IP

The most significant sources of error in determining R_{IP} , with typical values for standard deviation, are

- i) Uncertainty in RPV altitude ~ 3 m in 150 m i.e. 2% \pm
- ii) Undulating terrain. The effect of undulating terrain is exactly the same as variations in RPV altitude. Variations ~ 20 m are expected, i.e. 13% \pm .
- iii) Display marking. Errors in marking the display in elevation are again estimated at ~ 2% full scale. For a 20° vertical FOV this is 3 m rad.
- iv) Uncertainty in sensor attitude. The accuracy with which the sensor attitude is known in elevation is dependent on the equipment fit in the RPV. A value of 2 m rad is assumed. If the attitude is not known to this accuracy an estimate can probably be made from the position of the horizon.

For identification points at a nominal range of 1.5 km the above factors give the following independent errors

- | | | | | | | | |
|----|------|-----|-------|------|-------|-----|------|
| i) | 30 m | ii) | 200 m | iii) | 100 m | iv) | 25 m |
|----|------|-----|-------|------|-------|-----|------|

The combined effects of these errors and the basic matching error is 230 m.

As yet it has not been possible to quantify the navigation accuracy that could be achieved by the laser/terrain correlation system. It is a function of the terrain used and the accuracy of terrain representation. Preliminary results of the simulation described previously are available with the effects of errors in

- laser beam depression angle (2 m rad, 1 σ)
- laser range measurement (6 m, 1 σ)
- radio height measurement (5 m, 1 σ)
- terrain height representation (3 m, 1 σ)

represented. These results suggest that the technique is viable. Nevertheless the search technique used to obtain these results was very much simplified; for each navigation attempt the true vehicle position was presented to the system along with numerous points in the search area. In practice, the true position would not be available and some degradation in results would then be expected.

Further work is required to ascertain the relation between navigation accuracy and errors in terrain representation. However, since it appears that terrain representation is an important part of the concept, data taken directly from stereoscopic photographs should yield considerable improvement over data

taken from maps. Also careful consideration is required of the optimum search technique which should be used in practice.

5. CONCLUSIONS

A navigation concept has been presented whereby a good navigation accuracy (down to $\frac{1}{2}$ km) can be realised for an RPV with the minimum of on-board equipment. Table 1 summarises the accuracies of the various techniques available. It is proposed that several of these be incorporated into the overall RPV control and guidance system so that the controller can select the one most suitable for a given situation.

When a wide bandwidth data link can be maintained the map matching technique using JLR or YRLS offers the simplest and most accurate solution with the forward looking sensor as a good alternative. It does however, impose a large workload on the controller since, depending on the accuracy of the basic on-board system, the updating needs to be performed every few minutes. A separate navigator is therefore envisaged, keeping track of several RPVs. Electronic devices which are currently being developed to perform area correlation for automatic electro-optical tracking may lead to automation of the matching task in the future.

Where the data link is limited in bandwidth the laser/terrain correlation technique should give good accuracy and the process could be completely automated to provide a continuous indication of RPV position. Disadvantages of the system are the large amount of data storage and computation necessary at the control centre, the development work required to produce an operational system and the unsuitability of the system over featureless terrain.

Alternatively recourse can be made to a system based on measurements made from the relay stations. These are well established techniques offering good accuracy at short ranges and modest accuracy at long ranges. Again a completely automatic system is possible.

In the event of a total failure of the RPV control/guidance link, the on-board system would be adequate to allow the RPV to navigate itself back to a pre-defined recovery area.

7. ACKNOWLEDGEMENTS

The authors acknowledge the help given by E. G. Loftus and his colleagues during the preparation of the photographic material for this paper. Permission to publish the paper is by courtesy of Hawker Siddeley Aviation Limited. The opinions however are entirely those of the authors.

3. REFERENCES

1. Ramseyer K, 'Integrated Navigation by Least Square Adjustment', AGARD C.P. No. 54, September 1969, P. 18 - 1.
2. Bennett M.B., 'Optimal and Suboptimal Velocity - Aiding for VOR/DME Systems', IMAA Journal Vol. 10, No. 1, January 1972, P. 24.
3. Stansfield, E.J., 'Statistical Theory of D.F. Fixing', Proc. I.E.E. 94, Pt. III a, No. 15, 1947.
4. Aspin, W.M. 'Cosed - A Combined Display including a Full Electronic Facility and a Topographical Moving Map Display', AGARD C.P.P. No. 167, April 1975, P.30 - 1.
5. Slocus, G.K. 'Digital Scan Converters in Airborne Display Systems', AGARD C.P.P. No. 167, April 1975, P.23 - 1.

TABLE 1

Comparison of RPV Navigation Techniques

Technique	Accuracy-km (1 σ)	Comment
Compass/Air Data Basic On-board System	3.5 after 100 km	33% Distance gone Depends on wind estimates
Range-Bearing from Relay Station	1.8 at 100 km range	1 $^{\circ}$ Bearing accuracy
Cross Bearing Fix from Relay Stations	1.6 at 100 km range	1 $^{\circ}$ Bearing accuracy 100 km baseline
Laser Ranger-Terrain Map Correlation	0.5	Depends on the accuracy of the terrain representation
Map Matching with Rece Sensor	0.2	Accuracy limited by display system
Map Matching with Forward Looking Sensor	0.25	As above. Additional errors due to display matching etc. Altitude 150 m.

Continuous
Navigation

Update
Techniques

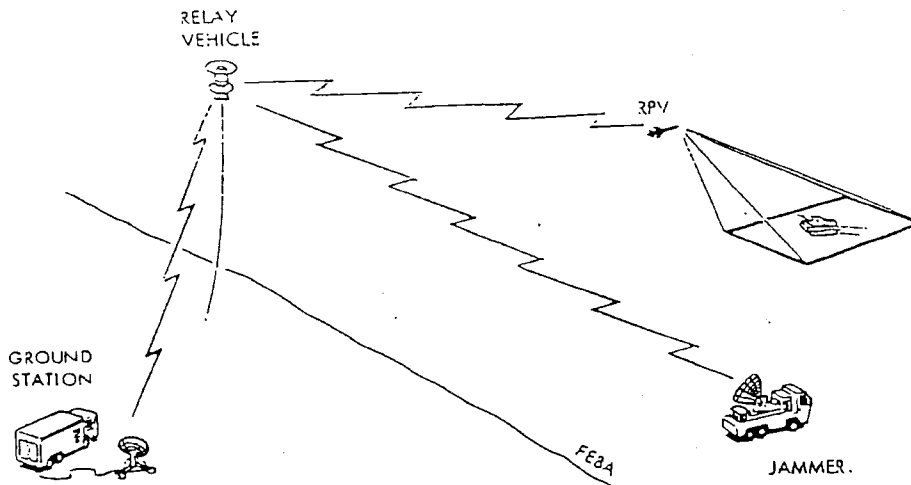

Fig. 1 RPV Operational Situation.

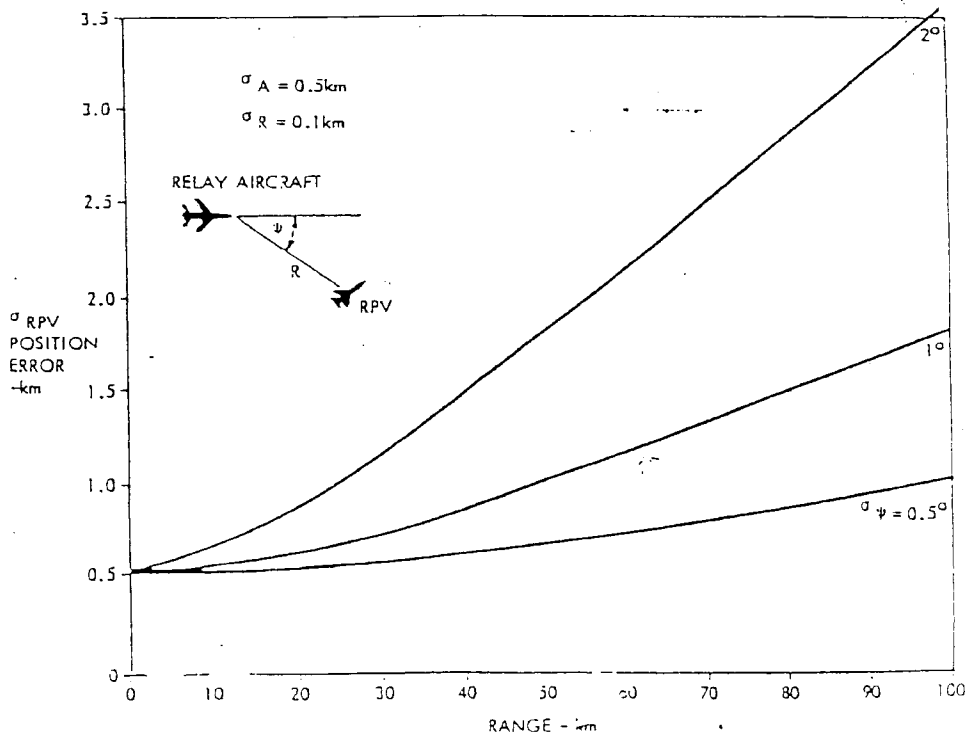

Fig. 2 Accuracy of DME System.

01587

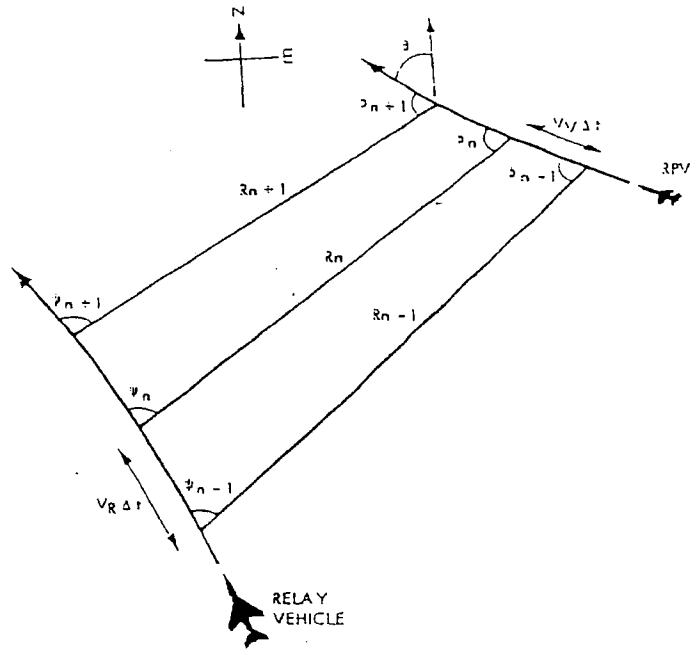
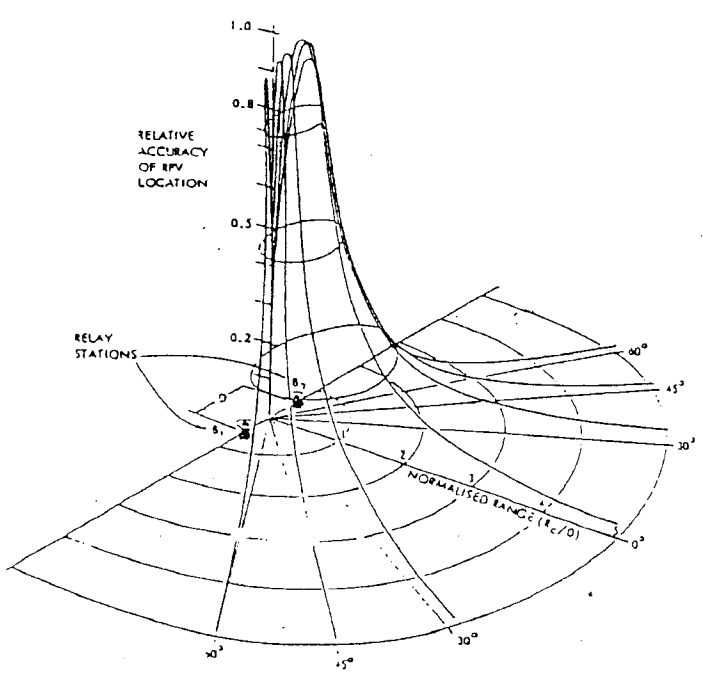

Fig. 5 Moving Window Tracking Technique



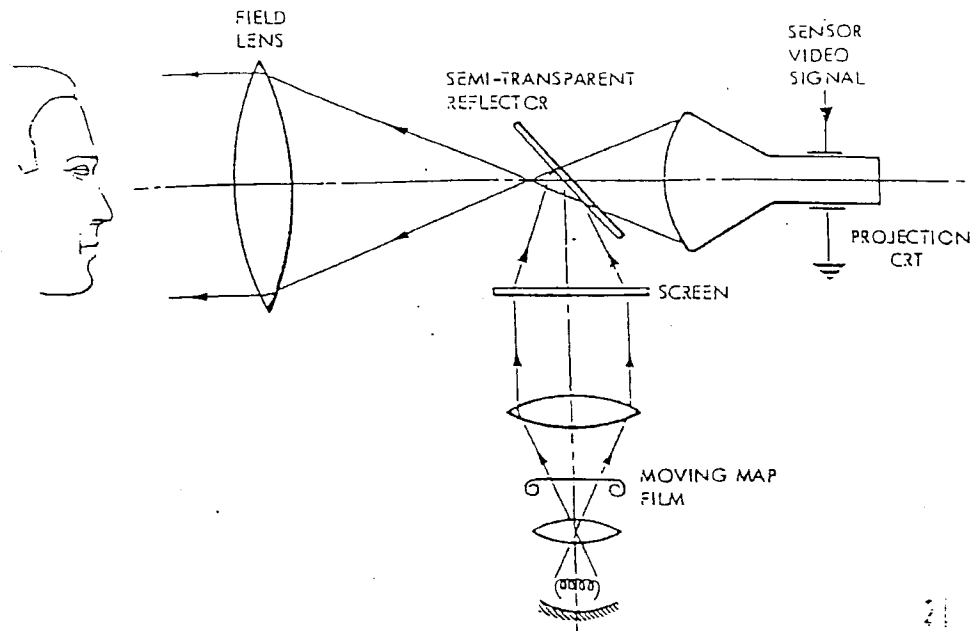

Fig. 5 Combined Moving Map/CRT Display.

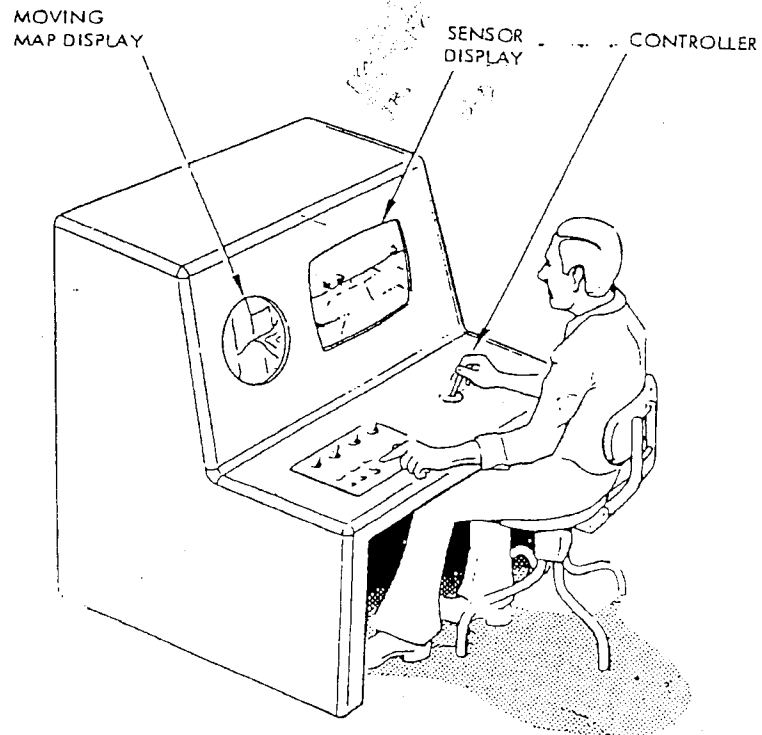
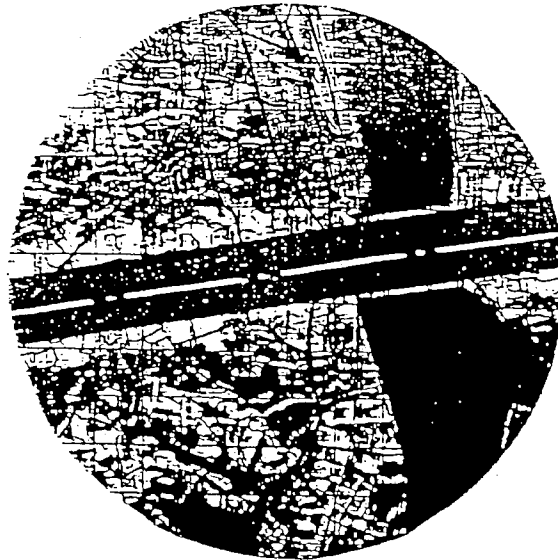

Fig. 6 RFV Controller's Console.

01533

*from aircraft
7/17*



B AIRCRAFT
FLIGHT
PATH

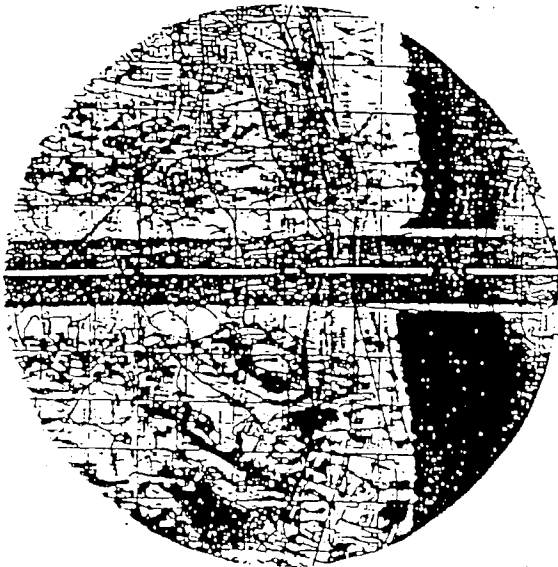

A AIRCRAFT
FLIGHT
PATH

Fig. 7 Simulated Silt/Map Update System.

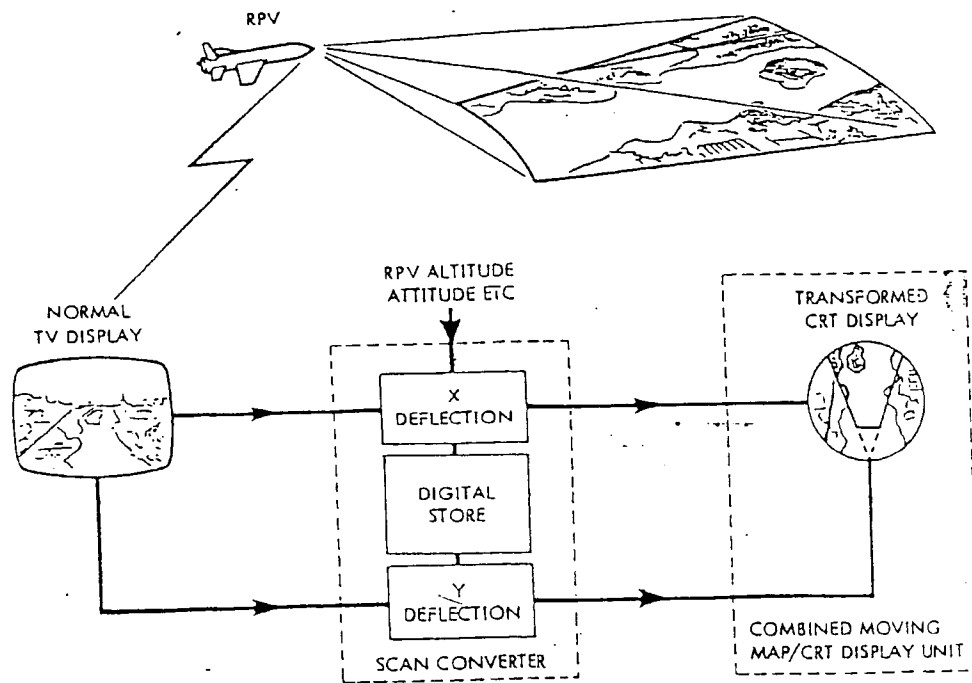

Fig. 8 Forward Looking Sensor Co-ordinate Transformation.

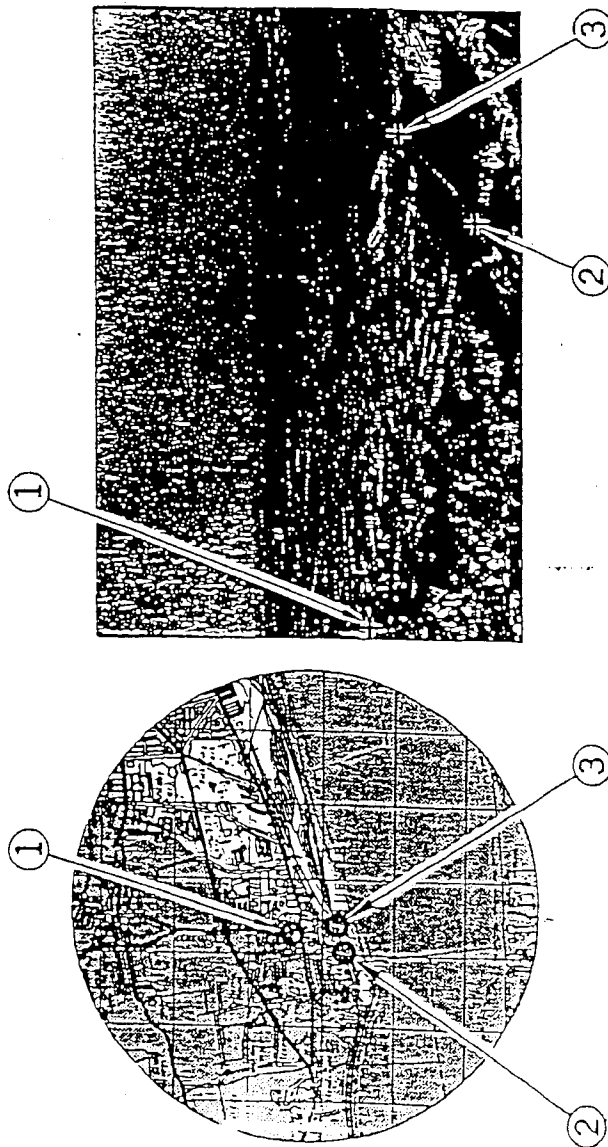

Fig. 9 Simulation of Marked Forward Looking Display/Map Update System.

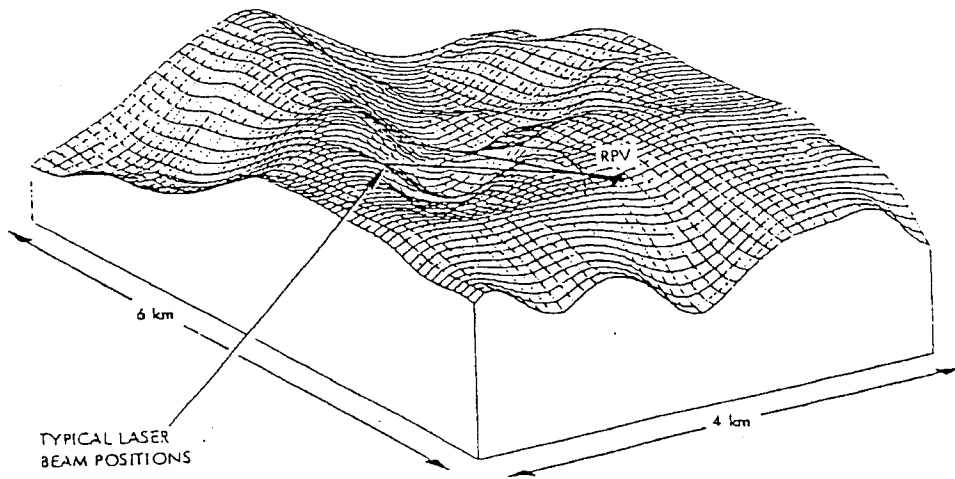

Fig. 10 Terrain Model.

- θ_L - LASER BEAM DEPRESSION ANGLE
- R - LASER RANGE
- RH - HORIZONTAL RANGE
- H - RADIO HEIGHT
- ΔH - HEIGHT DIFFERENCE

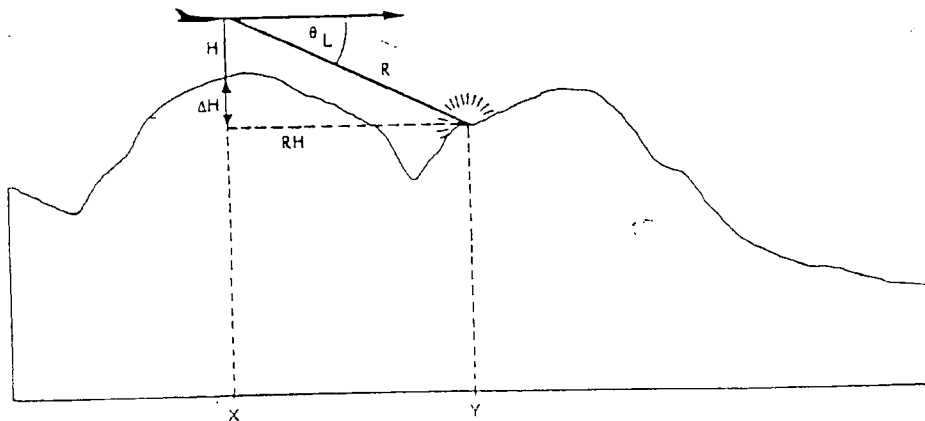

Fig. 11 Terrain Section.

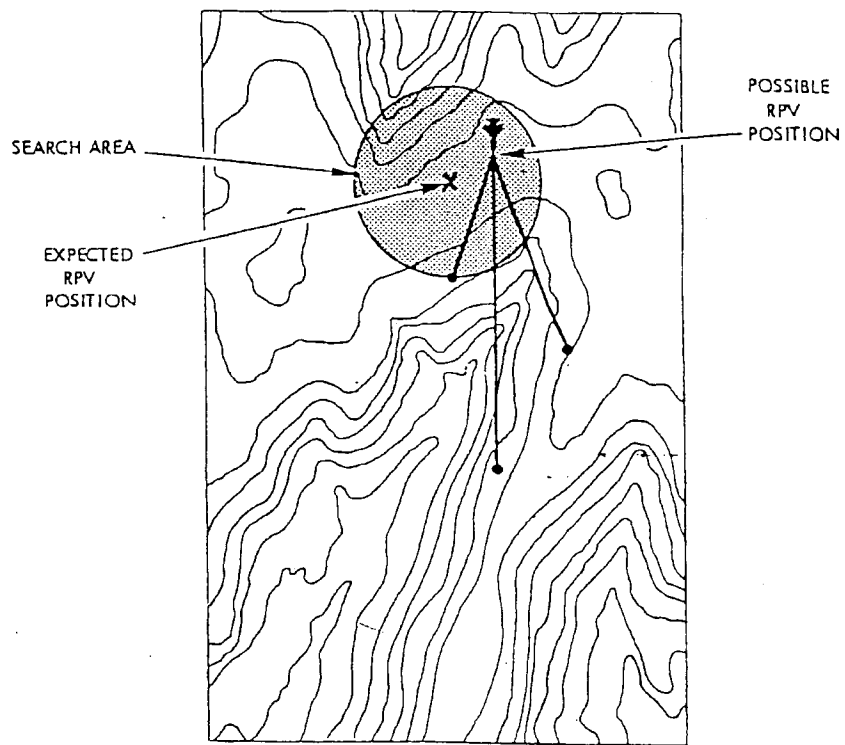

Fig. 12 Terrain Correlation Search.

DISCUSSION

D Halliwell, Decca Systems Study and Management Division, UK

Using the terrain map correlation method, are three ranges really able to give an unique position? There are probably many solutions in each case, only one of which is correct. After a false reset the true position may be outside the area of uncertainty for the next fix. Have your simulations shown any tendency to this effect?

J W Lyons, ESA, UK

For an error-free system three range measurements and radio height will in general be adequate to give an unique position within a limited area, though it is possible to conceive terrain configurations where this would not hold. The method will not work over flat featureless terrain. Also, in a real-world system, errors will be present and further range measurements will be necessary to smooth the effects of these. For convenience and to avoid a cluttered presentation only three measurements were illustrated in Fig. 12.

The area of uncertainty for the next fix depends on errors associated with the estimation of present position. However, when an update is attempted, a confidence level can be estimated based on how well the range measurements fit the stored terrain model. Only when a high confidence level is achieved is an update accepted.

C T J Jessop, Sperry Gyroscope Company, UK

To achieve the fix accuracies quoted what horizontal datum accuracy, in pitch and roll, is assumed for forward and sideways looking laser and radar sensors; and could these in fact approach inertial navigation system accuracy levels?

J D Bannister, ESA, UK

For the small laser beam depression angles assumed, the system is relatively insensitive to small changes in pitch and roll angles. The paper illustrates, in Fig. 11, that it is the horizontal range, RH , which is used for the correlation process. The error in RH will be small. However the question then arises as to the change in terrain height over the distance associated with the error in RH . This will depend very much on the nature of the terrain being overflown. The accuracy of the pitch and roll information thus determines the type of terrain over which the method provides a useful update facility. Also it should be borne in mind that the smoothing effect of taking a number of measurements is very powerful.

US GeoData Digital Elevation Models

Digital elevation models

Digital elevation model (DEM) data consist of an array of regularly spaced elevations. U.S. Geological Survey (USGS) DEM data are sold in 7.5-minute, 15-minute (Alaska only), and 1-degree units.

Data production

DEM data for 7.5-minute units are collected by four production methods: (1) the Gestalt Photo Mapper II (GPM2), an automated photogrammetric system designed to produce orthophotos, digital terrain data, and contours in subunits called patches; (2) manual profiling from photogrammetric stereomodels using stereoplotters equipped with three-axis electronic digital profile recording modules, by scanning stereomodels along successive terrain profiles; (3) interpolation of the elevations from stereomodel digitized contours, derived from stereoplotters equipped with three-axis digital recording modules used for compilation of 7.5-minute topographic quadrangle maps; and (4) interpolation from digital line graph (DLG) hypsographic and hydrographic data, collected using scanners, manual digitizers, and automated line followers.

DEM data for 15-minute units are derived from DLG hypsographic and hydrographic data.

DEM data for 1-degree units are collected from topographic map sources, ranging from the 7.5-minute map series to the 1- by 2-degree map series, or from photographic sources by using image correlation systems.

Unit size and file extent

DEM data for 7.5-minute units correspond to the USGS 7.5-minute topographic quadrangle map series for all of the United States and its territories except Alaska.

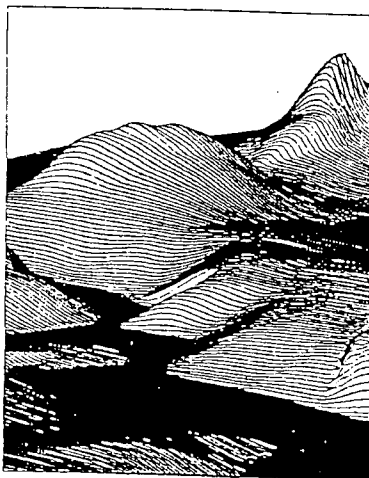

Portion of a 7.5-minute DEM plot of Tumwater, WA

DEM data for 15-minute units correspond to the USGS 15-minute topographic quadrangle map series in Alaska. The unit sizes in Alaska vary depending on the latitude. Units south of 59° N. cover 15- by 20-minute areas, those between 59° and 62° N. cover 15- by 22.5-minute areas, those between 62° and 68° N. cover 15- by 30-minute areas, and those north of 68° N. cover 15- by 36-minute areas. (All values are latitude-longitude, respectively.)

DEM data are produced by the Defense Mapping Agency in 1- by 1-degree units that correspond to the east or west half of USGS 1- by 2-degree topographic quadrangle map series (1:250,000 scale) for all of the United States and its territories. In Alaska these are west, central, and east files.

All nonstandard quadrangles with neat-lines that extend beyond the standard unit size to accommodate overedge boundaries are collected as multiples of the standard unit sizes. These data, therefore, are sold as two 7.5- by 7.5-minute units.

Data characteristics

All DEM data are similar in logical data structure and are ordered from south to north in profiles that are ordered from west to east. However, they differ in geographic reference systems and sampling intervals.

DEM data in 7.5-minute units consist of regular arrays of elevations arranged horizontally on the Universal Transverse Mercator (UTM) coordinate system of the North American Datum of 1927 (NAD 27). These data are stored as profiles with 30-meter spacing along and between each profile. The profiles do not always have the same number of elevations because of the variable angle between true north and grid north in the UTM system.

DEM data in 15-minute units consist of regular arrays of elevations arranged horizontally to the coordinate system of NAD 27. The spacing between elevations along profiles is 2 arc seconds of latitude by 3 arc seconds of longitude. Each profile has 451 elevations.

DEM data in 1-degree units consist of a regular array of elevations arranged horizontally using the coordinate system of the World Geodetic System 1972 Datum. A few units are also available using the World Geodetic System 1984 Datum. Spacing of the elevations along and between each profile is 3 arc seconds with 1,201 elevations per profile. The only exception is DEM data in Alaska, where the spacing and number of elevations per profile varies depending on the latitude. Latitudes between 50° and 70° N. have spacings at 6 arc seconds with 601 elevations per profile, and latitudes greater than 70° N. have spacings at 9 arc seconds with 401 elevations per profile.

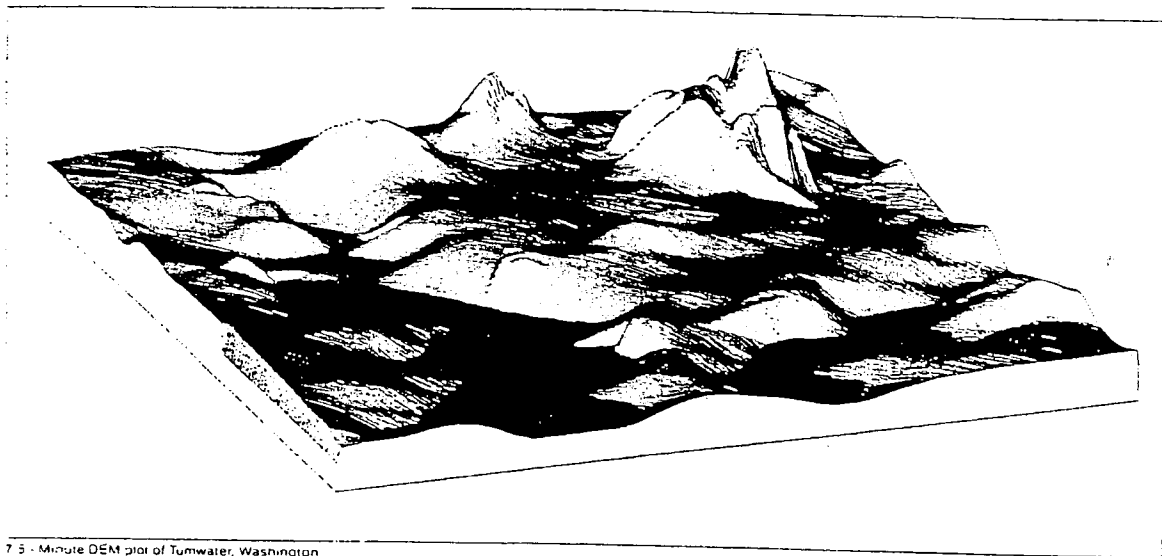

7.5 - Minute DEM plot of Tumwater, Washington

Data records

A DEM file is organized into three logical records, types A, B, and C. The type A record contains information defining the general characteristics of the DEM, including its name, boundaries, units of measurement, minimum and maximum elevations, number of type B records, and projection parameters. There is only one type A record per DEM file. The type B record contains profiles of elevation data and associated header information. There is a type B record for each profile. The type C record contains statistics on the accuracy of the data.

Data accuracy

The accuracy of DEM data depends on the source and resolution of the data samples. The accuracy of the 7.5-minute DEM data is derived by comparing linear interpolated elevations in the DEM with corresponding map location elevations and computing the statistical standard deviation or root-mean-square error (RMSE). The RMSE is used to describe the DEM accuracy. The vertical accuracy of 7.5-minute DEM's is 15 meters or better. The 15-minute DEM accuracy is one-half of a contour interval of the 15-minute topographic quadrangle map

or better. The 1-degree DEM data have an absolute accuracy of 130 meters horizontally and 30 meters vertically.

US GeoData Sampler

A US GeoData Sampler is available for a nominal charge. The sampler includes the 7.5-minute DEM and the 1:24,000-scale DLG for Tumwater, Washington; the 1:100,000-scale DLG for Tacoma, Washington; the 1:2,000,000-scale DLG for the northwestern States (WA, OR, and ID); 1- by 2-degree land use and land cover data for Seattle, Washington; the 1- by 1-degree DEM for Seattle, Washington East; and the Geographic Names Information System data for the State of Washington.

Ordering instructions

DEM data are written as ANSI-standard ASCII characters in fixed-block format on unlabeled or ANSI labeled 9-track magnetic tapes at a 1,600-bpi or 6,250-bpi density. The logical record length is 1,024 bytes with a physical record size of 4,096 bytes or four logical records. DEM data may be ordered by specifying the unit size, maximum block size, tape density, and tape label and by identifying the sales unit by topographic quadrangle name or

by the southeast latitude and longitude corner coordinates.

The US GeoData Sampler can be ordered in standard or optional ASCII DLG formats, on either one 6,250-bpi or three 1,600-bpi tapes.

The Earth Science Information Center can furnish indexes, price lists, and order forms. Data Users Guides are included with each order.

For further information, contact:

U.S. Geological Survey
Earth Science Information Center
507 National Center
Reston, Virginia 22092
1-800-USA-MAPS

01541

Structure of Digital Data

The Earth Science Information Centers (ESIC) distribute digital cartographic/geographic data files produced by the U.S. Geological Survey (USGS) as part of the National Mapping Program. The data files are grouped into four basic types. The first type, called a Digital Line Graph (DLG), is line map information in digital form. These data files include information on planimetric base categories, such as transportation, hydrography, and boundaries. The second type, called a Digital Elevation Model (DEM), consists of a sampled array of elevations for ground positions that are usually at regularly spaced intervals. The third type, Land Use and Land Cover digital data, provide information on nine major classes of land use such as urban, agricultural, or forest as well as associated map data such as political units and Federal land ownership. The fourth type, the Geographic Names Information System, provides primary information for known places, features, and areas in the United States identified by a proper name.

The digital cartographic data files from selected quadrangles currently available from ESIC include the following:

- Digital Elevation Models (DEM's)
 - 7.5-minute
 - 15-minute
 - 30-minute
 - 1-degree

- Digital Line Graphs (DLG's)
 - 1:24,000-scale
 - 1:62,500-scale
 - 1:63,360-scale
 - 1:100,000-scale
 - 1:2,000,000-scale

- Land Use and Land Cover digital data
 - 1:250,000- and 1:100,000-scale Land Use and Land Cover and associated maps
 - 1:250,000-scale Alaska Interim Land Cover

- Geographic Names Information System

The digital data are useful for the production of cartographic products such as plotting base maps and for various kinds of spatial analysis. A major use of these digital cartographic/geographic data is to combine them with other geographically referenced data, enabling scientists to conduct automated analyses in support of various decision making processes.

The information for the following pages on "Structure of Digital Data" was obtained from sections of the DATA USERS GUIDES listed:

DATA USERS GUIDES

- 1: Digital Line Graphs from 1:24,000-Scale Maps - \$2
- 2: Digital Line Graphs from 1:100,000-Scale Maps - \$1.50
- 3: Digital Line Graphs from 1:2,000,000-Scale Maps - \$1.50
- 4: Land Use and Land Cover from 1:2,000,000-Scale Maps - \$1
- 5: Digital Elevation Models - \$1
- 6: Geographic Names Information System - \$1
- 7: Alaska Interim Land Cover Mapping Program - \$1

Data Users Guides 1-7 replace Geological Survey Circular 895 B-G.

01542

DIGITAL ELEVATION MODELS

7.5-MINUTE DIGITAL ELEVATION MODELS

Characteristics

A 7.5-minute DEM has the following characteristics:

- The data consist of a regular array of elevations referenced horizontally in the UTM coordinate system. The reference datum may be North American Datum of 1927 (NAD 27), North American Datum of 1983 (NAD 83), Old Hawaiian Datum (OHD), or Puerto Rico Datum of 1940 (PRD).
- The unit of coverage is the 7.5-minute quadrangle. Overedge coverage is not provided.
- The data are ordered from south to north in profiles that are ordered from west to east.
- The data are stored as profiles in which the spacing of the elevations along and between each profile is 30 m.
- The profiles do not always have the same number of elevations because of the variable angle between the quadrangle's true north and the grid north of the UTM coordinate system.
- Elevations for the continental U.S. are either meters or feet referenced to the National Geodetic Vertical Datum of 1929 (NGVD 29). Elevations for Hawaii and Puerto Rico are either in meters or feet referenced to local mean sea level. DEM's of low-relief terrain or generated from contour maps with intervals of 10 ft (3 m) or less are generally recorded in feet. DEM's of moderate to high-relief terrain or generated from maps with terrain contour intervals greater than 10 ft are generally recorded in meters.

Profiles for 7.5-minute DEM's are generated by using a UTM cartesian coordinate system as a base. The profiles are clipped to the straight-line intercept between the four geographic corners of the quadrangle--an approximation of the geographic map boundary (neatline).

The resulting area of coverage for the DEM is a quadrilateral, the opposite sides of which are not parallel.

The UTM coordinates of the four corners (bounds) of the DEM's are listed in the type A record, as shown in table 1,* data element 11; the UTM coordinates of the starting points of each profile are listed in the type B record (profiles), table 2,* data element 3. These coordinates describe the shape of the quadrilateral and the variable x, y starting position of each profile. Because of the variable orientation of the quadrilateral in relation to the UTM coordinate system, profiles intersect the east and west neatlines as well as the north and south neatlines. In addition, DEM's have profile easting values that are continuous from one DEM to the adjoining DEM only if the adjoining DEM is contained within the same UTM zone.

* See Data Users Guide 5 - Digital Elevation Models

1-DEGREE DIGITAL ELEVATION MODELS

1-Degree DEM (3- x 3-arc-second data spacing). Provides coverage in 1- x 1-degree blocks. Two products (three in some regions of Alaska) provide the same coverage as a standard USGS 1- x 2-degree map series quadrangle. The basic elevation model is produced by or for the Defense Mapping Agency (DMA), but is distributed by USGS in the DEM data record format.

Characteristics

A 1-degree DEM has the following characteristics:

- The product consists of a regular array of elevations referenced horizontally on the geographic (latitude/longitude) coordinate system of the World Geodetic System 1972 Datum (WGS 72) or the World Geodetic System of 1984 (WGS 84).
- The unit of coverage is a 1- x 1-degree block. Elevation data on the integer degree lines (all four sides) correspond with the same profiles on the surrounding eight blocks.
- Elevations are in meters relative to NGVD 29 in the continental U.S. and local mean sea level in Hawaii and Puerto Rico.
- The data are ordered from south to north in profiles that are ordered from west to east.
- Spacing of the elevations along each profile is 3 arc-seconds. The first and last data points are at the integer degrees of latitude. A profile will therefore contain 1,201 elevations.
- Spacing between profiles varies by latitude; however, the first and last data points are at the integer degrees of longitude. North of 50° degrees N and south of 70° N, the spacing is 6 arc-seconds with 601 profiles per product. For the remainder of Alaska north of 70° N the spacing is 9 arc-seconds with 401 profiles per product.

For U.S. 1:250,000-scale 1 degree by 2 degree areas, you need to order TWO 1 degree by 1 degree DEM units: EAST HALF and WEST HALF. They are TWO separate DEM units with TWO separate costs: \$7 for each half for a total of \$14 for the entire area, if you are ordering six or more units.

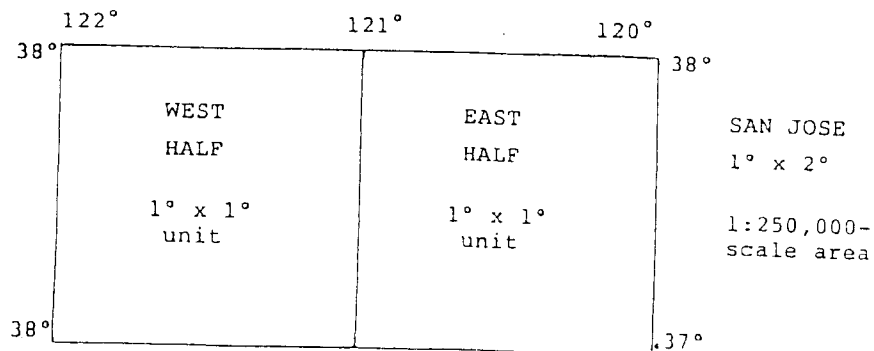

For ALASKA 1:250,000-scale DEMs, some areas require THREE units: EAST HALF, CENTRAL HALF and WEST HALF, if you want the entire

01544

ALASKA DIGITAL ELEVATION MODELS

- The product consists of a regular array of elevations referenced horizontally to the geographic (latitude/longitude) coordinate system of NAD 27 or NAD 83.
- Elevation data on the quadrangle neatlines (all four sides) share edge profiles with the surrounding eight quadrangles.
- Elevations are in meters or feet relative to NGVD 29.
- The data are ordered from south to north in profiles that are ordered from west to east.

Characteristics

7.5-MINUTE Alaska DEM's have the following characteristics:

- The unit of coverage corresponds to four basic quadrangle sizes for 1:24,000- and 1:25,000-scale graphics (depending on latitude):

Cell size limits

7.5 x 18 minutes	State of Alaska north of 68° N latitude
7.5 x 15 minutes	Between 62° N and 68° N latitude
7.5 x 11.25 minutes	Between 59° N and 62° N latitude
7.5 x 10 minutes	State of Alaska south of 59° N latitude

- The longitudinal limits of these cells are computed east and west of the -150 degree meridian. The north-south cell limits conform to even multiples of 7.5 minutes of latitude.
- The data are collected with a 1- x 2-arc-second spacing in latitude and longitude, respectively. The first and last data points along a profile are at the integer degrees of latitude. A profile will therefore contain 451 elevations.

Characteristics

15-MINUTE Alaska DEM's have the following characteristics:

- The unit of coverage corresponds to four basic quadrangle sizes for 1:63,360-scale graphics (depending on latitude):

Cell size limits

15 x 36 minutes	State of Alaska north of 68° N latitude
15 x 30 minutes	Between 62° N and 68° N latitude
15 x 22.5 minutes	Between 59° N and 62° N latitude
15 x 20 minutes	State of Alaska south of 59° N latitude

- The longitudinal limits of these cells are computed east and west of the -150 degree meridian. The north-south cell limits conform to even multiples of 15 minutes of latitude.
- The data are collected with a 2- x 3-arc-second spacing in latitude, and longitude, respectively. The first and last data points along a profile are at the integer degrees of latitude. A profile will therefore contain 451 elevations.

01545

US GeoData Digital Line Graphs

Digital line graph data

Digital line graph (DLG) data are digital representations of cartographic information. DLG's of map features are converted to digital form from maps and related sources. U.S. Geological Survey (USGS) DLG data are classified as large, intermediate, and small scale.

Data sources

Large-scale DLG data are derived from USGS 1:20,000-, 1:24,000-, and 1:25,000-scale 7.5-minute topographic quadrangle maps. If 7.5-minute maps are not available, sources are used in the following order of preference: (1) advance manuscripts for 7.5-minute maps; (2) published 15-minute quadrangles at 1:62,500 scale (1:63,360 scale for Alaska); and (3) archival compilation materials for 15-minute quadrangles such as 1:48,000-scale compilations.

Intermediate-scale DLG data are derived from USGS 1:100,000-scale 30- by 60-minute quadrangle maps. If these maps are not available, Bureau of Land Management planimetric maps at a scale of 1:100,000 are used, followed by archival compilation materials.

Small-scale DLG data are derived from such maps as the USGS 1:2,000,000-scale sectional maps of the National Atlas of the United States of America. Alaska hydrography data were collected at 1:1,000,000 scale from Landsat images from 1979. Other categories of data were revised from 1979-80 sources.

Unit size and file extent

Large-scale DLG data are produced in 7.5-minute units that correspond to USGS 1:20,000-, 1:24,000-, and 1:25,000-scale topographic quadrangle maps. However, some older units in the western United States cover 15-minute areas and correspond to maps at 1:62,500 scale. The unit sizes in Alaska vary depending on latitude. Units south of 59° N. cover

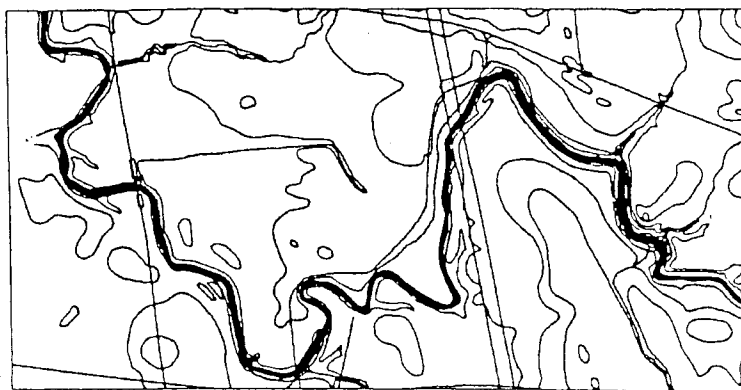

Plot of DLG data—northwest corner of Bombay, New York-Quebec Quadrangle, 1:24,000-scale showing hydrography, roads and trails, railroads, miscellaneous transportation, and hypsography.

15- by 20-minute areas; between 59° and 62° N., 15- by 22.5-minute areas; between 62° and 68° N., 15- by 30-minute areas; and north of 68° N., 15- by 36-minute areas (all values are latitude and longitude, respectively).

Intermediate-scale DLG data are sold in 30-minute units that correspond to the east or west half of USGS 30- by 60-minute 1:100,000-scale topographic quadrangle maps. Each 30-minute unit is produced and distributed as four 15- by 15-minute cells, except in high-density areas, where the 15-minute cells may be divided into four 7.5-minute cells.

Intermediate-scale hydrography and transportation DLG data are sold on compact disc-read only memory (CD-ROM). Each disc contains all the 15- by 15-minute cells within the 1:100,000-scale quadrangles that cover a State or States. Currently 3 areas within 14 planned sectional regions in the United States are available: Area 3—southeastern States of NC, SC, and GA; Area 4—FL; and Area 13—northwestern States of WA, OR, and ID.

Small-scale DLG data that correspond to USGS 1:2,000,000-scale sectional maps of the National Atlas are sold in 21 units. Fifteen sections cover the continental United States, five cover Alaska, and one

covers Hawaii. These sectional DLG's are usually sold in multi-State units. Some, however, may cover only one State or a portion of a State. All 21 units are available on a single CD-ROM.

All nonstandard quadrangles with neatlines that extend beyond the standard unit size to accommodate overedge boundaries are collected as multiples of the standard unit size. Data covering a 7.5- by 8.5-minute quadrangle area would, therefore, be sold as two 7.5-minute units.

Data content

Large-scale DLG data are available in nine categories: (1) hypsography, including contours and supplementary spot elevations; (2) hydrography, including flowing water, standing water, and wetlands; (3) vegetative surface cover, including woods, scrub, orchards, vineyards, and vegetative features associated with wetlands; (4) non-vegetative features, including lava, sand, and gravel; (5) boundaries, including State, county, city, and other national and State lands such as forests and parks; (6) survey control and markers, including horizontal and vertical positions (third order or better); (7) transportation, including roads and trails, railroads,

01546

Nh
1547

pipelines, and transmission lines; (8) manmade features, including cultural features not collected in other major data categories such as buildings; and (9) the Public Land Survey System, including township, range, and section line information.

Presently, intermediate-scale DLG's are sold in five categories: (1) Public Land Survey System; (2) boundaries; (3) transportation; (4) hydrography; and (5) hypsography.

Small-scale DLG data are sold in three categories: (1) boundaries, including political and administrative boundaries; (2) transportation, including roads and trails, railroads, and cultural features (airports and the Alaska pipeline); and (3) hydrography, including streams and water bodies, and hypsography (Continental Divide only). All of these categories are also included in the 1:2,000,000-scale CD-ROM.

Data structure

All DLG data distributed by the USGS are DLG - Level 3 (DLG-3), which means the data contain a full range of attribute codes, have full topological structuring, and have passed certain quality-control checks. The DLG-3 concept is based on graph theory in which a two-dimensional diagram is expressed as a direct graph composed of a set of nodes, lines, and areas that express logical relationships with minimal redundancy. Nodes define the end points of lines. A line is an ordered set of points that describe the position and shape of a linear feature of the map. An area is a continuous, unbroken region of the map bounded by lines. Applied to a map, this concept expresses spatial relationships between map elements that are obvious when the map is examined. The spatial relationships between features on a map include concepts such as location, adjacency, and connections. Data that maintain the spatial relationships inherent in the map are topologically structured.

Attribute codes

Attribute codes are used to describe the physical and cultural characteristics of DLG node, line, and area elements. Attribute codes are used to reduce redundant information, provide enough reference

information to support integration with larger data base, and describe the relationships between cartographic elements. Each DLG element has one or more attribute codes composed of a three-digit major code and a four-digit minor code. For example, with the 1:2,000,000-scale DLG data, the line attribute code 290 5001 has a major code (290), meaning road, with a minor code (5001) identifying the road as an interstate.

Data formats

Large- and intermediate-scale DLG's are available in standard and optional formats. The standard format has reduced storage requirements, 144-byte logical record length, an internal file coordinate system (thousandths of a map inch), and topological linkages contained only in the line elements. The optional format is easy to use with an 80-byte logical record length, a ground planimetric coordinate system (Universal Transverse Mercator), and topological linkages contained in node, line, and area elements.

Small-scale DLG's are available in standard, optional, and graphic formats. The standard format is the same as the large- and intermediate-scale DLG's. The optional format is also the same as the large and intermediate scales, except that it uses the ground planimetric coordinate system of the Albers Equal-Area Conic projection. The graphic format is compatible with Geological Survey Cartographic Automatic Mapping (GS-CAM) plotting software, with a 20-byte logical record length; a geographic (latitude-longitude) coordinate system expressed in degrees, minutes, and seconds; and no topological linkages. All three formats are available on the 1:2,000,000-scale CD-ROM.

Data records

The standard format data are organized into 9 record types and the optional format data into 11 record types. For descriptions of these record types, refer to Data Users Guide 1—Digital Line Graphs from 1:24,000-Scale Maps, Data Users Guide 2—Digital Line Graphs from 1:100,000-Scale Maps, and Data Users Guide 3—Digital Line Graphs from 1:2,000,000-Scale Maps.

The graphic format data are DLG line records organized by feature type and

reformatted into two record types: one line identifier record and multiple latitude-longitude records.

Data accuracy validation

DLG data do not carry quantified accuracy statements. However, the data files are checked and validated before they are released for distribution for file fidelity and completeness, attribute accuracy, and topological fidelity. For large- and intermediate-scale DLG's, additional data validation such as edge matching and quality control flagging is performed.

US GeoData Sampler

The US GeoData Sampler is available for a nominal charge. Data contents include the 7.5-minute digital elevation model (DEM) and the 1:24,000-scale DLG for Tumwater, Washington; the 1:100,000-scale DLG for Tacoma, Washington; the 1:2,000,000-scale DLG for the northwestern States (WA, OR, and ID); the 1- by 2-degree land use and land cover data for Seattle, Washington; the 1- by 1-degree DEM for Seattle, Washington East; and the Geographic Names Information System data for the State of Washington.

Ordering instructions

DLG data are written as ANSI-standard ASCII characters in fixed-block format on unlabeled or ANSI labeled nine-track magnetic tape at a 1,600-bpi or 6,250-bpi density. DLG's may be ordered by specifying the scale, format, maximum block size, tape density, tape label, and either the topographic quadrangle name or section, or the southeast latitude and longitude corner coordinates of the sales unit.

The US GeoData Sampler can be ordered by name and is offered in standard or optional ASCII DLG formats, on either one 6,250-bpi or three 1,600-bpi tapes.

To assist you in ordering, the Earth Science Information Center (ESIC) can furnish indexes, price lists, and order forms. Data Users Guides are included with each order.

For further information, contact the USGS, Earth Science Information Center, 507 National Center, Reston, VA 22092, or call 1-800-USA-MAPS.

DIGITAL LINE GRAPHS FROM 1:24,000-SCALE MAPS

This document describes the Digital Line Graphs (DLG's) prepared primarily from the 1:24,000 materials associated with the USGS Topographic Map Series. The series will eventually provide complete national coverage.

DATA CONTENT

The DLG data files derived from the 1:24,000-scale and other large-scale maps contain selected base categories of cartographic data in digital form; these data categories do not necessarily correspond to the traditional feature separates associated with the maps. The attribute coding scheme for these data has undergone several revisions since the start of the digital program. A major revision of these codes has been printed as Standards for Digital Line Graphs - Part 3, Attribute Coding, which is available for purchase from a USGS ESIC office (see the ordering information inside the front cover). Currently, DLG data entered in the National Digital Cartographic Data Base (NDCDB) are coded in accordance with the Standards for Digital Line Graphs. The implementation of the new coding standards will require the updating of existing files in the NDCDB in order to have a consistent product available for users. Software and procedures are being developed to convert existing data files to these codes during the next several years. Priority will be given to converting files retrieved in response to sales requests. In the meantime, a data base query will provide identification of the coding scheme used for any file in the NDCDB. This information will be supplied to customers when orders are submitted, and upon transmittal of data files. The following categories are included in current large-scale DLG files:

- Boundaries -- This category of data consists of (1) political boundaries that identify States, counties, cities, and other municipalities, and (2) administrative boundaries that identify areas such as National and State forests. Political and administrative boundaries are always collected as a single data set.
- Hydrography -- This category of data is currently being collected as combined hydrography consisting of all flowing water, standing water, and wetlands.

Prior to 1983, hydrographic data were differentiated into two components: streams and water bodies. Streams represent flowing water and were digitized as a network intended for hydrologic flow modeling. Streams included the banks of double-line rivers and centerline connectors placed through double-line rivers and lakes. Water bodies include standing water such as lakes and ponds. Wetlands and coastal hydrographic data were not collected.

- Public Land Survey System (PLSS) -- This category of data describes the rectangular system of land surveys that is administered by the U.S. Bureau of Land Management. PLSS data are only collected for areas falling solely, or in part, within the States that were formed from the public domain. The PLSS subdivides the public domain and represents property boundaries or references to property boundaries. These DLG data are not intended to be official or authoritative. They are presented as cartographic reference information. The only legal basis for determining land boundaries remains the original survey.

DIGITAL LINE GRAPHS FROM 1:24,000-SCALE MAPS

continued

- Transportation -- This category of data includes major transportation systems collected in three separate overlays labeled: (1) Roads and Trails, (2) Railroads, and (3) Pipelines, Transmission Lines, and Miscellaneous Transportation Features.

In the last quarter of 1985, new transportation attribute codes were implemented. The principal difference between the old and new coding schemes is that under the old transportation subcategory, certain miscellaneous transportation features were not collected and descriptive attribute codes were not used.

- Other Significant Manmade Structures -- This category of data includes miscellaneous cultural features not included in the other major data categories.

New attribute codes for Other Significant Manmade Structures were implemented in the last quarter of 1985. Very little data from this category currently reside in the NDCDB.

The attribute codes for the following base categories were newly defined in late 1985. Currently, there are very little data available in these categories.

- Hypsography -- This category of data consists of information on topographic relief (primarily contour data).
- Surface Cover -- This category of data consists of information about vegetative surface cover such as woods, scrub, orchards, and vineyards. Vegetative features associated with wetlands, such as marshes and swamps, are collected under Hydrography.
- Non-Vegetative Surface Features -- This category of data consists of information about the natural surface of the Earth as symbolized on the map such as lava, sand, and gravel features. This category is not all-inclusive, as other non-vegetative surface features are found in the category of Hydrography.
- Survey Control and Markers -- This category of data consists of information about the points of established position and third-order or better elevations that are used as fixed references in positioning and correlating map features.

01500

DIGITAL LINE GRAPHS FROM 1:2,000,000-SCALE MAPS

DATA CONTENT

The DLG data files derived from the 1:2,000,000-scale maps contain selected base categories of cartographic data in digital form. The data files are derived from the sectional maps of the 1970 National Atlas of the United States of America. The following categories are included in current 1:2,000,000-scale DLG files:

- Boundaries -- This category of data includes boundary information collected in two separate subcategories: (1) Political Boundaries and (2) Administrative Boundaries.
- Hydrography -- This category of data includes features collected in three separate subcategories: (1) Streams, (2) Water Bodies, and (3) Hypsography (Continental Divide only).
- Transportation -- This category of data includes major transportation systems collected in three separate subcategories: (1) Roads and Trails, (2) Railroads, and (3) Cultural Features (airports and Alaska pipeline).

DISTRIBUTION FORMATS

The 1:2,000,000-scale DLG data are available in three distribution formats: (1) standard, (2) optional, and (3) graphic.

The Standard distribution format was designed to minimize storage requirements. Explicit topological linkages are contained only in the line elements.

The Optional distribution format was designed for data interchange. These files are typically larger than those in the standard format but, for certain applications, can simplify processing requirements. Topological linkages are explicitly encoded between all line and node elements, and all line and area elements. This structure allows a polygon data structure to be easily created.

The Graphic distribution format was designed to be compatible with the GS-CAM (Geological Survey - Cartographic Automatic Mapping) software. This software provides for plotting line and point information using a variety of map projections, scales, and graphic symbologies.

The files in the graphic distribution format are derived from the topologically structured DLG data described above, and contain a subset of the line and attribute code information in the DLG files. No node or area information is stored in these files. These files are not topologically structured.

The small-scale (1:2,000,000-scale) DLG sectional U.S. coverage data is available on a CD-ROM for \$32.

DIGITAL LINE GRAPHS FROM 1:100,000-SCALE MAPS

DATA CONTENT

The DLG data files derived from the 1:100,000-scale maps contain selected base categories of cartographic data in digital form; these data categories do not necessarily correspond to the traditional feature separates associated with the maps. The following categories are included in current 1:100,000 DLG files:

- Hydrography -- This category of data describes combined hydrography consisting of all flowing water, standing water, and wetlands.
- Transportation -- This category of data includes major transportation systems collected in three separate subcategories labeled: (1) roads and trails, (2) railroads, and (3) pipelines, transmission lines, and miscellaneous transportation.
- Hypsography -- This category of data consists of information on topographic relief (primarily contour data), and supplementary spot elevations.
- Boundaries -- This category of data consists of (1) political boundaries that identify States, counties, cities, and other municipalities, and (2) administrative boundaries that identify areas such as National and State forests. Political and administrative boundaries are always collected as a single data set.
- Public Land Survey System (PLSS) -- This category of data describes the rectangular system of land surveys that is administered by the U.S. Bureau of Land Management. PLSS data are only collected for areas falling solely, or in part, within the States that were formed from the public domain. The PLSS subdivides the public domain and represents property boundaries or references to property boundaries. These DLG data are not intended to be official or authoritative. They are presented as cartographic reference information. The only legal basis for determining land boundaries remains the original survey.

The hypsography, boundary, and PLSS categories were authorized for production in late 1987. Currently there is very little data available in these categories.

The remaining categories: manmade features, survey control, vegetative surface cover, and nonvegetative features are projected to enter the production phase in 1990.

01552

DIGITAL LINE GRAPHS

DISTRIBUTION FORMATS

The 1:24,000-scale and other large-scale DLG data are available in two distribution formats: (1) standard and (2) optional.

The **Standard** distribution format is intended to minimize storage requirements. Explicit topological linkages are contained only in the line elements (starting node, ending node, area to the left of direction of travel, area to the right of direction of travel).

The **Optional** distribution format was designed to facilitate data usage. The topological relationships explicitly encoded include starting node, ending node, area to the left of direction of travel and area to the right of direction of travel for line elements, bounding lines for area elements, and bounding lines for node elements. These files are typically larger than those in the standard format but, for certain applications, can simplify processing requirements. For example, topological linkages are explicitly encoded for all line, node, and area elements, allowing a polygon data structure to be easily created. These linkages facilitate GIS applications of DLG data as well as generation of graphic products.

The characteristics of the standard and optional DLG formats are

Standard and optional DLG format

	Standard	Optional
Character set	8-bit ASCII	8-bit ASCII
Logical record length	144 bytes	80 bytes
Physical record length (blocksize)	Variable in multiples of 144 bytes.	Variable in multiples of 80 bytes.
Coordinate system	Internal file (thousandths of a map inch).	Ground planimetric (UTM).
Topological linkages	Contained only in line elements.	Contained in node, area, and line elements.

01553

DIGITAL LINE GRAPHS FROM 1:2,000,000-SCALE MAPS --continued

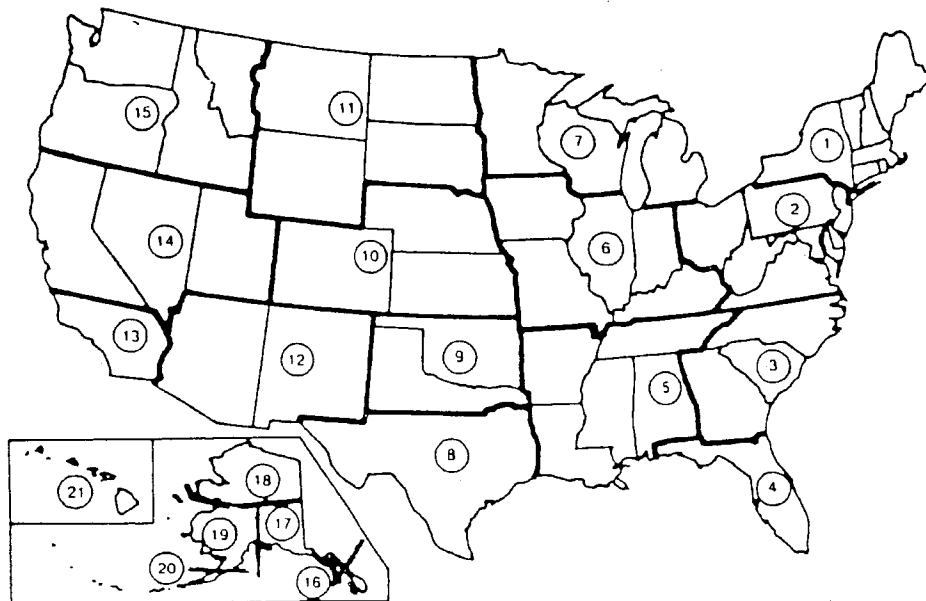

Multistate cells used for Digital Line Graphs from 1:2,000,000-scale maps.

INDEX MAP

- 1 NORTHEASTERN STATES
- 2 MIDDLE ATLANTIC STATES
- 3 SOUTHEASTERN STATES
- 4 FLORIDA
- 5 SOUTHERN MISSISSIPPI VALLEY STATES
- 6 CENTRAL MISSISSIPPI VALLEY STATES
- 7 NORTHERN GREAT LAKES STATES
- 8 SOUTHERN TEXAS
- 9 SOUTHERN PLAINS STATES
- 10 CENTRAL PLAINS STATES
- 11 NORTHERN PLAINS STATES
- 12 ARIZONA AND NEW MEXICO
- 13 SOUTHERN CALIFORNIA
- 14 CENTRAL PACIFIC STATES
- 15 NORTHWESTERN STATES
- 16 SOUTHEASTERN ALASKA
- 17 CENTRAL ALASKA
- 18 NORTHERN ALASKA
- 19 SOUTHWESTERN ALASKA
- 20 ALEUTIAN ISLANDS
- 21 HAWAIIAN ISLANDS

APPENDIX --Sample DLG Data File (Standard Distribution Format)
 (Each 144-character record is shown as two consecutive 72-character lines)

GLEN ELLEN 1968 24000

3 1 10 -0.122033045000000D 09 0.380180450000000D 08 0.0
 0.0 0.0 0.0

0.0 0.0 0.0
 0.0 0.0 0.0
 0.0 2 0.610000000000000D 00 0 4
 -0.122625000000000D 03 0.382500000000000D 02 -0.122625000000000D 03
 0.383750000000000D 02 -0.122500000000000D 03 0.383750000000000D 02
 -0.122500000000000D 03 0.382500000000000D 02

0.609594407590000D 00 -0.288178569420000D-02 0.538248793410000D 06
 0.424037445560000D 07 4

SW -8971-11376NW -8955 11375NE 8955 11376SE 8971-11376

1

BOUNDARIES (24425) 795 16 795 7 530 20

N 1 -8971-11376 0 0
 N 2 -8955 11375 0 0
 N 3 8955 11376 0 0
 N 4 8971-11376 0 0
 N 5 -8966 3203 0 0
 N 6 2101 11374 0 0
 N 7 5832 11376 0 0
 N 8 7513 11376 0 0
 N 9 8956 7494 0 0
 N 10 8961 2884 0 0
 N 11 3469 10371 0 0
 N 12 5530 9112 0 0
 N 13 -3115-10127 0 0
 N 14 7520 11175 1 0

90 1

01555

APPENDIX --Standard DLG Distribution Format (Record Contents)

In the standard DLG distribution format, the topological linkages are contained only in the line elements. The files are physically comprised of standard 8-bit ASCII characters organized into fixed-length logical records of 144 characters. Nine distinct record types are defined.

<u>Logical record type</u>	<u>Content</u>
A	Header record containing DLG identification information.
B	Header record containing projection information and registration points.
C	Header record identifying data categories contained in this DLG and indicating the number of nodes, areas, and lines in each category.
D.1	A node or an area record.
D.2	A line record.
E	Record containing x,y coordinate string.
F	Record containing attribute codes.
G	Record containing text string (not currently used).
H	Accuracy estimate (not currently used).

The actual sequence of records in a standard distribution DLG file is as follows:

1. Header records
 - Type A (one record)
 - Type B (one record)
 - Type C (one record)
2. Data records

<ul style="list-style-type: none"> Node records Node description (D.1) Attribute codes (F) Text string (G) 	}	<ul style="list-style-type: none"> Repeated for each node within a data category 	}	<ul style="list-style-type: none"> Repeated for each area within a data category
<ul style="list-style-type: none"> Area records Area description (D.1) Attribute codes (F) Text string (G) 	}	<ul style="list-style-type: none"> Repeated for each area within a data category 	}	<ul style="list-style-type: none"> Repeated for each data category
<ul style="list-style-type: none"> Line records Line description (D.2) x,y coordinates (E) Attribute codes (F) Text string (G) 	}	<ul style="list-style-type: none"> Repeated for each line within a data category 	}	
3. Accuracy estimate
 - Type H (one record) (not currently used)

APPENDIX --Sample DLG Data File (Optional Distribution Format)
 (Each 80-character record is shown as a single line.)

USGS-NHD DLG DATA - CHARACTER FORMAT - 09-29-82 VERSION
 GLEN ELLEN 1968 24000

```

      3      1      10      2 0.61000000000D+00      4      0      4      1
-0.122033045000000D+09  0.380180450000000D+08  0.0
0.0 0.0 0.0 0.0
0.0 0.0 0.0 0.0
0.0 0.0 0.0 0.0
0.10000000000D+01 0.0 0.0 0.0
SW 38.250000 -122.625000 532812.91 4233413.86
NW 38.375000 -122.625000 532757.10 4247282.79
NE 38.375000 -122.500000 543674.93 4247335.01
SE 38.250000 -122.500000 543750.25 4233465.56
BOUNDARIES (24425) 0 16 16 010 7 7 010 20 20 1
N 1 532812.91 4233413.86 2 0 0
1 -10
N 2 532757.10 4247282.79 2 0 0
-2 3
N 3 543674.93 4247335.01 2 0 0
-6 7
N 4 543750.25 4233465.56 2 0 0
-9 10
N 5 532773.94 4242301.15 3 0 0
-1 2 12
N 6 539496.77 4247314.04 3 0 0
-3 4 17
N 7 541771.16 4247326.01 3 0 0
-4 5 -19
N 8 542795.89 4247330.85 3 0 0
-5 6 -14
N 9 543686.72 4244968.57 3 0 0
-7 8 -15
N 10 543703.06 4242158.35 3 0 0
-8 9 -20
N 11 540333.59 4246706.56 3 0 0
-16 -17 18
N 12 541593.59 4245945.02 3 0 0
-18 19 20
N 13 536379.09 4234192.12 2 0 0
11 -11
N 14 542800.74 4247208.34 2 1 0
14 15
90 1
N 15 537351.64 4243171.97 2 1 0
-12 13
90 1
N 16 538780.02 4243415.25 2 1 0
-13 16
90 1
    
```

01557

APPENDIX --Optional DLG Distribution Format (Record Contents)

In the optional DLG distribution format, topological linkages are explicitly encoded for node and area elements as well as for line elements. The files are physically comprised of 8-bit ASCII characters organized into fixed-length logical records of 80 characters (bytes). Bytes 1-72 of each record may contain DLG data, and bytes 73-80 may contain a record sequence number.

The 11 distinct record types used in the optional DLG distribution format may be categorized as header and data records.

Four types of records are considered header records:

- File identification and description records
- Accuracy records (not currently used)
- Control-point identification records
- Data-category identification records

Seven types of records are considered data records:

- Node and area identification records
- Node-to-line linkage records
- Area-to-line linkage records
- Line identification records (also contains line-to-node and line-to-area linkages)
- Coordinate string records
- Attribute code records
- Text records (not currently used)

The actual sequence of records in an optional distribution format DLG file is as follows:

1. Header records

Ten file identification and description records
Accuracy records (not currently used)
Control point identification records
(one per control-point)
Data category identification records
(one per data category in the file)

2. Data records

Node identification record	} Repeated for each node within a data category	} Repeated for each data category
Node-to-line linkage record(s)		
Attribute code record(s)		
Text record(s)		
Area identification record	} Repeated for each area within a data category	
Area-to-line linkage record(s)		
Attribute code record(s)		
Text record(s)		
Line identification records	} Repeated for each line within a data category	
Coordinate string record(s)		
Attribute code record(s)		
Text record(s)		

01558

08/587,731



UNITED STATES DEPARTMENT OF COMMERCE
Patent and Trademark Office

Address: COMMISSIONER OF PATENTS AND TRADEMARKS
Washington, D.C. 20231

APPLICATION NUMBER	FILING DATE	FIRST NAMED APPLICANT	ATTORNEY DOCKET NO.
08/587,731	01/19/96	MARGOLIN	J 002055.P004

B3M1/0723
BLAKELY SOKOLOFF TAYLOR AND ZAFMAN
12400 WILSHIRE BOULEVARD
7TH FLOOR
LOS ANGELES CA 90025

EXAMINER

NGUYEN, T

ART UNIT PAPER NUMBER

2304

3

DATE MAILED: 07/23/97

This is a communication from the examiner in charge of your application.
COMMISSIONER OF PATENTS AND TRADEMARKS

OFFICE ACTION SUMMARY

Responsive to communication(s) filed on January 19, 1996

This action is FINAL.

Since this application is in condition for allowance except for formal matters, prosecution as to the merits is closed in accordance with the practice under *Ex parte Quayle*, 1935 D.C. 11; 453 O.G. 213.

A shortened statutory period for response to this action is set to expire -3- month(s), or thirty days, whichever is longer, from the mailing date of this communication. Failure to respond within the period for response will cause the application to become abandoned. (35 U.S.C. § 133). Extensions of time may be obtained under the provisions of 37 CFR 1.136(a).

Disposition of Claims

Claim(s) 1-49 is/are pending in the application.

Of the above, claim(s) _____ is/are withdrawn from consideration.

Claim(s) _____ is/are allowed.

Claim(s) 1-49 is/are rejected.

Claim(s) _____ is/are objected to.

Claims _____ are subject to restriction or election requirement.

Application Papers

See the attached Notice of Draftsperson's Patent Drawing Review, PTO-948.

The drawing(s) filed on _____ is/are objected to by the Examiner.

The proposed drawing correction, filed on _____ is approved disapproved.

The specification is objected to by the Examiner.

The oath or declaration is objected to by the Examiner.

Priority under 35 U.S.C. § 119

Acknowledgement is made of a claim for foreign priority under 35 U.S.C. § 119(a)-(d).

All Some* None of the CERTIFIED copies of the priority documents have been

received.

received in Application No. (Series Code/Serial Number) _____

received in this national stage application from the international Bureau (PCT Rule 17.2(a)).

*Certified copies not received: _____

Acknowledgement is made of a claim for domestic priority under 35 U.S.C. § 119(e).

Attachment(s)

Notice of Reference Cited, PTO-892

Information Disclosure Statement(s), PTO-1449, Paper No. 2

Interview Summary, PTO-413

Notice of Draftsperson's Patent Drawing Review, PTO-948

Notice of Informal Patent Application, PTO-152

01550

- SEE OFFICE ACTION ON THE FOLLOWING PAGES -

Serial No.: 08/587,731
Art Unit: 2304

2

DETAILED ACTION

Notice to Applicant(s)

1. This application has been examined. Claims 1-49 are pending.
2. The prior art submitted on January 19, 1996 has been considered.

Drawings

3. The drawings are objected to under 37 CFR § 1.84 for the reasons set forth by the draftsman. See attached PTO-948 form for details. Correction is required.
However, correction of the noted defect can be deferred until the application is allowed by the examiner.

Claim Rejections - 35 USC § 102

4. The following is a quotation of the appropriate paragraphs of 35 U.S.C. § 102 that form the basis for the rejections under this section made in this Office action:

A person shall be entitled to a patent unless --
(b) the invention was patented or described in a printed publication in this or a foreign country or in public use or on sale in this country, more than one year prior to the date of application for patent in the United States.

01500

Serial No.: 08/587,731
Art Unit: 2304

3

5. Claims 1-9, 14-18, 23-32, and 34-45 rejected under 35 U.S.C. § 102(b) as being anticipated by Lyons et al. (an article entitled "Some Navigation Concepts For Remotely Piloted Vehicles", AGUARD Conference Proceedings No. 176 on Medium Accuracy Low Cost Navigation, September 1975, pages 5-1 to 5-15).

a. With respect to claims 1, 14, and 39, Lyons et al. disclose the invention as claimed (see at least the abstract) including a remotely piloted aircraft (see figure 8, RPV), a communications system for communicating flight data between a computer and said remotely piloted aircraft, said flight data including said remotely piloted aircraft's position and orientation, said flight data also including flight control information for controlling said remotely piloted aircraft (see page 5-2, section Radio Navigation Using a Data Link, and figure 6 and the related text), a digital database comprising terrain data (see pages 5-3 and 5-4, section Terrain Map Correlation; and figure 8). Lyons et al. further disclose that the computer accesses said terrain data according to said remotely piloted aircraft's position and to transform said terrain data to provide three dimensional projected image data according to said remotely piloted aircraft's orientation; a display for displaying said three dimensional projected image data (see page 5-4, third paragraph, and figure 8), and a remote flight control coupled to said computer for inputting said flight control information (see figure 6).

Therefore, all of the limitations of claim 1 are met by Lyons et al.

01551

Serial No.: 08/587,731
Art Unit: 2304

4

b. With respect to claim 2, Lyons also disclose that remotely piloted aircraft including a position determining system for locating said remotely piloted aircraft's position in three dimensions and an orientation determining system for determining said remotely piloted aircraft's orientation in three dimensional space (see pages 5-4 and 5-5, section Navigation Accuracy).

c. With respect to claim 3, Lyons et al. disclose that the flight data communicated between said remotely piloted aircraft and said computer is secured (see page 5-2, first paragraph of the Radio Navigation Using Data Link section).

d. With respect to claims 4, 5, 7, and 15, Lyons et al. disclose that said remotely piloted aircraft further comprises a infra red sensor image (video camera) and means for communicating and displaying video data representing images captured by the sensor image (see page 5-3, section Map Matching, and figure 8).

e. With respect to claims 6 and 16, Lyons et al. disclose that the video data is transmitted on a different communication link (wideband transmission of video signals) than said flight data (see page 5-2, first paragraph of section Radio Navigation Using a Data Link).

f. With respect to claims 8, 17, and 44, Lyons et al. disclose that the display is a head mounted display (see figures 5 and 6).

g. With respect to claims 9, 18, and 45, Lyons et al. also disclose that the

01562

Serial No.: 08/587,731
Art Unit: 2304

5

remote flight control is responsive to manual manipulations (see figure 6).

h. With respect to claim 23, Lyons et al. disclose that the communications unit includes at least one of a communications transceiver and a simulation port (see page 5-4 and figure 6).

i. With respect to claim 24, Lyons et al. further disclose that the database representing terrain using polygons (see figure 10).

j. With respect to claims 25-28 and 30-31, the limitations of these claims have been noted in the rejection above. They are therefore considered rejected as set forth above.

k. With respect to claim 29, wherein said video data is transmitted real-time (see page 5-3, first paragraph of the section Map Matching).

l. Claims 32 and 34-38 are method claims corresponding to apparatus claims 24-31. Therefore, claims 32 and 34-38 are rejected for the same rationales set forth for claims 24-31.

m. With respect to claim 40-42, Lyons et al. disclose that the simulation unit includes a network interface configured to communicate battlefield simulation information with a simulation network, said communications system also configured to communicate said battlefield simulation information between said simulation unit and said computer, said computer also configured to display one or more other simulated

01563

Serial No.: 08/587,731
Art Unit: 2304

6

entities described by said battlefield simulation information (see the Introduction, Terrain Map Correlation sections, and figures 7, 9).

n. With respect to claim 43, Lyons et al. disclose that the simulation unit further comprises an aerodynamic model processor for aiding in simulating said remotely piloted aircraft (see page 5-4, second paragraph).

Claim Rejections - 35 USC § 103

6. The following is a quotation of 35 U.S.C. 103(a) which forms the basis for all obviousness rejections set forth in this Office action:

(a) A patent may not be obtained though the invention is not identically disclosed or described as set forth in section 102 of this title, if the differences between the subject matter sought to be patented and the prior art are such that the subject matter as a whole would have been obvious at the time the invention was made to a person having ordinary skill in the art to which said subject matter pertains. Patentability shall not be negated by the manner in which the invention was made.

7. Claims 10, 11, 19, 20, 33, 46, and 47 are rejected under 35 U.S.C. 103(a) as

01564

Serial No.: 08/587,731
Art Unit: 2304

7

being unpatentable over Lyons et al. as applied to claims 1-9, 14-18, 23-32, and 34-45, and further in view of Kanaly (4,405,943).

Lyons et al. disclose the claimed invention as discussed above except for the determination of a delay time for communicating said flight data between said computer and said remotely piloted aircraft, and adjusting the sensitivity of said set of one or more remote flight controls based on said delay time. However, Kanaly does suggest delay time for communicating between the ground station and the remote airborne into account of controlling the remote airborne (see at least column 3, lines 15-24, and column 8, line 54 to column 9, line 6). It would have been obvious to incorporate the teaching of Kanaly into the system of Lyons et al. in order to improve the system with the enhanced capability of providing more accurate the remote flight controls to the remoted vehicle and receiving the accurate position and heading data of the vehicle from the remoted vehicle.

8. Claims 12-13, 21-22, and 48-49, rejected under 35 U.S.C. 103(a) as being unpatentable over Lyons et al. as applied to claims 1-9, 14-18, 23-32, and 34-45 above, and further in view of Thornberg et al. (5,552,983).

Lyons et al. disclose the claimed invention as discussed above except that the remote flight controls allows for inputting absolute pitch and roll angles. However,

01565

Serial No.: 08/587,731
Art Unit: 2304

8

such feature is well known in the art at the time the invention was made. For example, Thornberg et al. suggest a variable referenced control system for remotely operated vehicles which includes means for inputting absolute pitch and roll angles for remotely control the unmanned aerial vehicle (see at least figures 5 and 6). It would have been obvious to one of ordinary skill in the art at the time the invention was made to incorporate the teaching of Thornberg et al. into the system of Lyons et al. in order to input the pitch and roll control signals as the flight control signals for remotely control the vehicle.

Conclusion

9. All claims are rejected.
10. The following references are cited as being of general interest: Diamantides (3,742,495), Brocard et al. (4,218,702), Narendra et al. (4,855,822), Loard (5,015,187), Fitzpatrick et al. (5,072,396), Rahim (5,155,683), Eiband et al. (5,240,207), Steinitz et al. (5,266,799), and Khvilivitsky.
11. Any inquiry concerning this communication or earlier communications from the examiner should be directed to examiner Tan Nguyen, whose telephone number is (703) 305-9755. The examiner can normally be reached on Monday-Thursday from

01566

Serial No.: 08/587,731
Art Unit: 2304

9

7:30 AM-5:00 PM. The examiner can also be reached on alternate Fridays.

If attempts to reach the examiner by telephone are unsuccessful, the examiner's supervisor, Kevin J. Teska, can be reached on (703) 305-9704.

Any inquiry of a general nature or relating to the status of this application should be directed to the Group receptionist whose telephone number is (703) 305-3800.

Any response to this action should be mailed to:

Commissioner of Patents and Trademarks
Washington, D.C. 20231

or faxed to:

(703) 308-9051, (for formal communications intended for entry)

Or:

(703) 308-5357 (for informal or draft communications, please label "PROPOSED" or "DRAFT")

Hand-delivered responses should be brought to Crystal Park II, 2121 Crystal Drive, Arlington, VA., Sixth Floor (Receptionist).

/tqn
July 18, 1997

Tan Nguyen

TAN Q. NGUYEN
PATENT EXAMINER
GROUP 2300

01567

Notice of References Cited

Application No. **08/587,731** Applicant(s) **MARGOLIN**
 Examiner **TAN NGUYEN** Group Art Unit **23024** Page **1** of **1**

U.S. PATENT DOCUMENTS

*	DOCUMENT NO.	DATE	NAME	CLASS	SUBCLASS
A	3,742,495	06/1973	DIAMANTIDES	342	64
B	4,218,702	08/1980	BROCARD ET AL.	348	144
C	4,855,822	08/1989	NAREIRA ET AL.	364	423.099
D	5,015,187	05/1991	LORD	364	462
E	5,072,396	12/1991	FITZPATRICK ET AL.	364	450
F	5,155,683	10/1992	RAHIM	364	424.029
G	5,240,207	08/1993	EIBAND ET AL.	364	423.099
H	5,266,799	11/1993	STEINTZ ET AL.	324	330
I	5,552,983	09/1996	THORNBERG ET AL.	364	424.027
J	5,581,250	12/1996	KHIVILIVKY	340	961
K					
L					
M					

FOREIGN PATENT DOCUMENTS

*	DOCUMENT NO.	DATE	COUNTRY	NAME	CLASS	SUBCLASS
N						
O						
P						
Q						
R						
S						
T						

NON-PATENT DOCUMENTS

*	DOCUMENT (Including Author, Title, Source, and Pertinent Pages)	DATE
U		
V		
W		
X		

* A copy of this reference is not being furnished with this Office action.
 (See Manual of Patent Examining Procedure, Section 707.05(a).)

Notice of References Cited

Application No. 88/587,731 Applicant(s) MARGOLIN
 Examiner TAN NGUYEN Group Art Unit 2763 Page 1 of 1

U.S. PATENT DOCUMENTS

*	DOCUMENT NO.	DATE	NAME	CLASS	SUBCLASS
A	<u>4,660,157</u>	<u>04/1987</u>	<u>BECKWITH ET AL.</u>	<u>345</u>	<u>421</u>
B	<u>4,835,532</u>	<u>05/1989</u>	<u>FANT</u>	<u>382</u>	<u>284</u>
C	<u>5,381,338</u>	<u>01/1995</u>	<u>WYSOCKI ET AL.</u>	<u>348</u>	<u>116</u>
D					
E					
F					
G					
H					
I					
J					
K					
L					
M					

FOREIGN PATENT DOCUMENTS

*	DOCUMENT NO.	DATE	COUNTRY	NAME	CLASS	SUBCLASS
N						
O						
P						
Q						
R						
S						
T						

NON-PATENT DOCUMENTS

*	DOCUMENT (Including Author, Title, Source, and Pertinent Pages)	DATE
U		
V		
W		
X		

01569

8

* A copy of this reference is not being furnished with this Office action.
 (See Manual of Patent Examining Procedure, Section 707.05(a).)

NOTICE OF DRAFTSPERSON'S PATENT DRAWING REVIEW

PTO Draftspersons review all originally filed drawings regardless of whether they are designated as formal or informal. Additionally, patent filers must review the drawings for compliance with the regulations. Direct telephone inquiries concerning the results to the Drawing Review Branch, 703-305-8401.

The drawings filed (formal/informal) 1/19/96 are informal

1 not objected to by the Draftsperson under 37 CFR 1.84 or 1.152.

0 objected to by the Draftsperson under 37 CFR 1.84 or 1.152 as indicated below. The examiner will require submission of new, corrected drawings when necessary. Corrected drawings must be submitted according to the instructions on the back of this notice.

- DRAWINGS, 37 CFR 1.84(a):** Acceptable categories of drawings:
 - Black ink. Color: _____
 - Not blue ink solid lines. Fig(s) _____
 - Color drawings are not acceptable until position is granted. Fig(s) _____
- PHOTOGRAPHS, 37 CFR 1.84(b):**
 - Photographs are not acceptable until position is granted. Fig(s) _____
 - Photographs not properly mounted (must use crystal board or photographic double-weight paper). Fig(s) _____
 - Poor quality (half tone). Fig(s) _____
- GRAPHIC FORMS, 37 CFR 1.81 (d):**
 - Chemical or mathematical formula not labeled as separate figure. Fig(s) _____
 - Group of waveforms not presented as a single figure, using common vertical axis with time extending along horizontal axis. Fig(s) _____
 - Individuals waveform not identified with a separate letter designation adjacent to the vertical axis. Fig(s) _____
- TYPE OF PAPER, 37 CFR 1.84(c):**
 - Paper not flexible, strong, white, smooth, nonshiny, and durable. Sheet(s) _____
 - Erasures, alterations, overwritings, interferences, cracks, creases, and folds copy machine marks not accepted. Fig(s) _____
 - Mylar, vellum paper is not acceptable (too thin). Fig(s) _____
- SIZE OF PAPER, 37 CFR 1.84(f):** Acceptable sizes:
 - 21.6 cm. by 35.6 cm. (8 1/2 by 14 inches)
 - 21.6 cm. by 33.1 cm. (8 1/2 by 13 inches)
 - 21.6 cm. by 27.9 cm. (8 1/2 by 11 inches)
 - 21.0 cm. by 29.7 cm. (DIN size A4)
 - All drawing sheets not the same size. Sheet(s) _____
 - Drawing sheet not an acceptable size. Sheet(s) _____
- MARGINS, 37 CFR 1.84(g):** Acceptable margins:

Paper size			
21.6 cm. X 35.6 cm. (8 1/2 X 14 inches)	21.6 cm. X 33.1 cm. (8 1/2 X 13 inches)	21.6 cm. X 27.9 cm. (8 1/2 X 11 inches)	21.0 cm. X 29.7 cm. (DIN Size A4)
T 5.1 cm. (2")	2.5 cm. (1")	2.5 cm. (1")	2.5 cm.
L .64 cm. (1/4")	.64 cm. (1/4")	.64 cm. (1/4")	2.5 cm.
R .64 cm. (1/4")	.64 cm. (1/4")	.64 cm. (1/4")	1.5 cm.
B .64 cm. (1/4")	.64 cm. (1/4")	.64 cm. (1/4")	1.0 cm.

 - Margins do not conform to chart above. Sheet(s) _____
 - Top (T) _____ Left (L) _____ Right (R) _____ Bottom (B) _____
- VIEWS, 37 CFR 1.84(h):**
 - REMINDER: Specification may require revision to correspond to drawing changes.
 - All views not grouped together. Fig(s) _____
 - Views connected by projection lines or lead lines. Fig(s) _____
 - Partial views. 37 CFR 1.84(h) 2 _____
 - View and enlarged view not labeled separately or properly. Fig(s) _____
 - Sectional views. 37 CFR 1.84 (h) 3 _____
 - Hatching not indicated for a critical portions of an object. Fig(s) _____
 - Cross section not drawn same as view (both parts in cross section with regularly spaced parallel oblique strokes). Fig(s) _____
- ARRANGEMENT OF VIEWS, 37 CFR 1.84(i):**
 - Views do not appear on a horizontal, left-to-right fashion when page is either upright or turned so that the top becomes the right side, except for graphs. Fig(s) _____
- SCALE, 37 CFR 1.84(k):**
 - Scale not large enough to show mechanism with crowding when drawing is reduced in size to two-thirds in reproduction. Fig(s) _____
 - Indication such as "actual size" or scale 1/2" not permitted. Fig(s) _____
- CHARACTER OF LINES, NUMBERS, & LETTERS, 37 CFR 1.84(l):**
 - Lines, numbers & letters not uniformly thick and well defined, clean, durable, and black (except for color drawings). Fig(s) _____
- SHADING, 37 CFR 1.84(m):**
 - Solid black shading areas not permitted. Fig(s) _____
 - Shade lines, pale, rough and blurred. Fig(s) _____
- NUMBERS, LETTERS, & REFERENCE CHARACTERS, 37 CFR 1.84(p):**
 - Numbers and reference characters not plain and legible. 37 CFR 1.84(p)(1) Fig(s) _____
 - Numbers and reference characters not oriented in same direction as the view. 37 CFR 1.84(p)(1) Fig(s) _____
 - English alphabet not used. 37 CFR 1.84(p)(2) Fig(s) _____
 - Numbers, letters, and reference characters do not measure at least .32 cm. (1/8 inch) in height. 37 CFR(p)(3) Fig(s) _____
- LEAD LINES, 37 CFR 1.84(q):**
 - Lead lines cross each other. Fig(s) _____
 - Lead lines missing. Fig(s) _____
- NUMBERING OF SHEETS OF DRAWINGS, 37 CFR 1.84(t):**
 - Sheets not numbered consecutively, and in Arabic numerals, beginning with number 1. Sheet(s) _____
- NUMBER OF VIEWS, 37 CFR 1.84(u):**
 - Views not numbered consecutively, and in Arabic numerals, beginning with number 1. Fig(s) _____
 - View numbers not preceded by the abbreviation Fig. Fig(s) _____
- CORRECTIONS, 37 CFR 1.84(w):**
 - Corrections not made from prior PTO-948. Fig(s) _____
- DESIGN DRAWING, 37 CFR 1.152:**
 - Surface shading shown not appropriate. Fig(s) _____
 - Solid black shading not used for color contrast. Fig(s) _____

COMMENTS:

ATTACHMENT TO PAPER NO. 3

REVIEWER acc

DATE 3/3/96

PTO Copy

01570

08/587,731



UNITED STATES DEPARTMENT OF COMMERCE
Patent and Trademark Office

Address: COMMISSIONER OF PATENTS AND TRADEMARKS
Washington, D.C. 20231

SERIAL NUMBER	FILING DATE	FIRST NAMED APPLICANT	ATTORNEY DOCKET NO.
08/587,731	01/19/96	MARGOLIN	J 002055.F004

BGM1/0912
BLAKELY SOKOLOFF TAYLOR AND ZAFMAN
12400 WILSHIRE BOULEVARD
7TH FLOOR
LOS ANGELES CA 90025

EXAMINER	
APPROVED, T	PAPER NUMBER
	A

DATE MAILED:

EXAMINER INTERVIEW SUMMARY RECORD

All participants (applicant, applicant's representative, PTO personnel):

09/12/97

- (1) DANIEL DE VOS (3) _____
 (2) TAN NGUYEN (4) _____

Date of interview 09/11/97

Type: Telephonic Personal (copy is given to applicant applicant's representative).

Exhibit shown or demonstration conducted: Yes No. If yes, brief description: _____

Agreement was reached with respect to some or all of the claims in question. was not reached.

Claims discussed: 1-49+

Identification of prior art discussed: Lyons et al. (an article entitled "Some Navigational Concepts For Remotely Piloted Vehicles")

Description of the general nature of what was agreed to if an agreement was reached, or any other comments: The reference has been discussed. Examiner agreed to reconsider the application in light of the ~~argo~~ discussion and the formal amendment

(A fuller description, if necessary, and a copy of the amendments, if available, which the examiner agreed would render the claims allowable must be attached. Also, where no copy of the amendments which would render the claims allowable is available, a summary thereof must be attached.)

Unless the paragraphs below have been checked to indicate to the contrary, A FORMAL WRITTEN RESPONSE TO THE LAST OFFICE ACTION IS NOT WAIVED AND MUST INCLUDE THE SUBSTANCE OF THE INTERVIEW (e.g., items 1-7 on the reverse side of this form). If a response to the last Office action has already been filed, then applicant is given one month from this interview date to provide a statement of the substance of the interview.

It is not necessary for applicant to provide a separate record of the substance of the interview.

Since the examiner's interview summary above (including any attachments) reflects a complete response to each of the objections, rejections and requirements that may be present in the last Office action, and since the claims are now allowable, this completed form is considered to fulfill the response requirements of the last Office action.

Tan Nguyen
Examiner's Signature

01571

002055.P004

Patent

S/A
gmm
10-5-97

IN THE UNITED STATES PATENT AND TRADEMARK OFFICE

<p>In re Application of: Jed Margolin</p> <p>Serial No. 08/587,731</p> <p>Filed: January 19, 1996</p> <p>For: A Method and Apparatus for Remotely Piloting an Aircraft</p>
--

Examiner: T. Nguyen

Art Unit: 2304

Assistant Commissioner for Patents
Washington, D.C. 20231

AMENDMENT AND REMARK

Sir:

Responsive to the Office Action mailed on July 23, 1997, the Applicant respectfully requests the Examiner to enter the following amendment and to consider the following remark:

AMENDMENT

In the Claims:

Please cancel Claims 39-49, without prejudice.

I hereby certify that this correspondence is being transmitted by facsimile to the United States Patent and Trademark Office in accordance with 37 CFR § 1.6(d), on the date shown below.

Name: Constance Van Dalen

Signature: Constance Van Dale

Date: September 11, 1997

01577

Attorney's Docket No.: 002055.P004 Patent
 In re the Application of: Jed Margolin (Inventor(s))
 Application No.: 08/587,731
 Filed: January 19, 1996
 For: A Method and Apparatus for Remotely Piloting an Aircraft
 (title)

ASSISTANT COMMISSIONER FOR PATENTS
 Washington, D.C. 20231

SIR: Transmitted herewith is an Amendment for the above application.

Small entity status of this application under 37 C.F.R. §§ 1.9 and 1.27 has been established by a verified statement previously submitted.
 A verified statement to establish small entity status under 37 C.F.R. §§ 1.9 and 1.27 is enclosed.
 No additional fee is required.

The fee has been calculated as shown below:

		(Col. 1)	(Col. 2)	(Col. 3)	SMALL ENTITY		OTHER THAN A SMALL ENTITY	
		Claims Remaining After Amd.	Highest No. Previously Paid For	Present Extra	Rate	Additional Fee	Rate	Additional Fee
Total Claims	*	38	** 49	0	x11	\$	x22	\$ 0
Indep. Claims	*	4	*** 5	0	x40	\$	x80	\$ 0
<input type="checkbox"/> First Presentation of Multiple Dependent Claim(s)					+130	\$	+260	\$
* If the entry in Col. 1 is less than the entry in Col. 2, write "0" in Col. 3. ** If the "Highest No. Previously Paid For" IN THIS SPACE is less than 20, write "20" in this space. *** If the "Highest No. Previously Paid For" IN THIS SPACE is less than 3, write "3" in this space. The "Highest No. Previously Paid For" (Total or Independent) is the highest number found from the equivalent box in Col. 1 of a prior amendment or the number of claims originally filed.					Total Add. Fee	\$	Total Add. Fee	\$ 0

I hereby certify that this correspondence is being transmitted by facsimile to the United States Patent and Trademark Office in accordance with 37 CFR § 1.6(d), on the date shown below.

Name: Constance Van Dalen
 Signature: *Constance Van Dalen*
 Date: September 11, 1997

01512

_____ A check in the amount of \$ _____ is attached for presentation of additional claim(s).
Applicant(s) hereby Petition(s) for an Extension of Time of _____ month(s) pursuant to
37 C.F.R. § 1.136(a).

_____ A check for \$ _____ is attached for processing fees under 37 C.F.R. § 1.17.

_____ Please charge my Deposit Account No. ~~02-2666~~ the amount of \$ _____.
A duplicate copy of this sheet is enclosed.

The Commissioner of Patents and Trademarks is hereby authorized to charge payment of the
following fees associated with this communication or credit any overpayment to Deposit
Account No. ~~02-2666~~ (a duplicate copy of this sheet is enclosed):

Any additional filing fees required under 37 C.F.R. § 1.16 for presentation of
extra claims.

Any extension or petition fees under 37 C.F.R. § 1.17.

Date: 9/4, 1997

12400 Wilshire Boulevard
Seventh Floor
Los Angeles, California 90025
(408) 720-8598

BLAKELY SOKOLOFF TAYLOR & ZAFMAN LLP

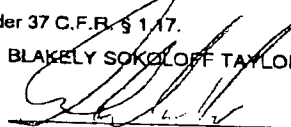
Daniel M. De Vos

Reg. No. 37,813

01573

Attorney's Docket No.: 002055.P004 Patent
 In re the Application of: Jed Margolin (inventor(s))
 Application No.: 08/587,731
 Filed: January 19, 1996
 For: A Method and Apparatus for Remotely Piloting an Aircraft
(title)

ASSISTANT COMMISSIONER FOR PATENTS
 Washington, D.C. 20231

SIR: Transmitted herewith is an Amendment for the above application.

- Small entity status of this application under 37 C.F.R. §§ 1.9 and 1.27 has been established by a verified statement previously submitted.
 A verified statement to establish small entity status under 37 C.F.R. §§ 1.9 and 1.27 is enclosed.
 No additional fee is required.

The fee has been calculated as shown below:

		(Col. 1)			(Col. 2)	(Col. 3)	SMALL ENTITY		OTHER THAN A SMALL ENTITY	
		Claims Remaining After Amd.	Minus	Highest No. Previously Paid For	Minus	Present Extra	Rate	Additional Fee	Rate	Additional Fee
Total Claims	*	38		49	**	0	x11	\$	x22	\$ 0
Indep. Claims	*	4		5	***	0	x40	\$	x80	\$ 0
<input type="checkbox"/> First Presentation of Multiple Dependent Claim(s)							+130	\$	+260	\$
							Total Add. Fee	\$	Total Add. Fee	\$ 0

- * If the entry in Col. 1 is less than the entry in Col. 2, write "0" in Col. 3.
- ** If the "Highest No. Previously Paid For" IN THIS SPACE is less than 20, write "20" in this space.
- *** If the "Highest No. Previously Paid For" IN THIS SPACE is less than 3, write "3" in this space. The "Highest No. Previously Paid For" (Total or Independent) is the highest number found from the equivalent box in Col. 1 of a prior amendment or the number of claims originally filed.

I hereby certify that this correspondence is being transmitted by facsimile to the United States Patent and Trademark Office in accordance with 37 CFR § 1.6(d), on the date shown below.

Name: Constance Van Dalen
 Signature: *Constance Van Dalen*
 Date: September 11, 1997

01574

_____ A check in the amount of \$ _____ is attached for presentation of additional claim(s).
_____ Applicant(s) hereby Petition(s) for an Extension of Time of _____ month(s) pursuant to 37 C.F.R. § 1.136(a).

_____ A check for \$ _____ is attached for processing fees under 37 C.F.R. § 1.17.

_____ Please charge my Deposit Account No. 02-2666 the amount of \$ _____.
A duplicate copy of this sheet is enclosed.

The Commissioner of Patents and Trademarks is hereby authorized to charge payment of the following fees associated with this communication or credit any overpayment to Deposit Account No. 02-2666 (a duplicate copy of this sheet is enclosed):

Any additional filing fees required under 37 C.F.R. § 1.16 for presentation of extra claims.

Any extension or petition fees under 37 C.F.R. § 1.17.

BLAKELY SOKOLOFF TAYLOR & ZAFMAN LLP

ORIGINAL SIGNED BY

Daniel M. De Vos

D.M.D.

Reg. No. 37,813

Date: 9/11, 1997

12400 Wilshire Boulevard
Seventh Floor
Los Angeles, California 90025
(408) 720-8598

01575

09/11/97 THU 18:00 FAX 4087209397

B S T & Z

001

BLAKELY 1279 Oak Road Parkway
SOKOLOFF Sunnyvale, California 94086
TAYLOR & (408) 720-8598 Telephone
ZAFMAN (408) 720-9397 Facsimile

A Limited Liability
Partnership Including
Law Corporations

OFFICIAL Facsimile Transmittal Sheet

Date: 9/11/97

URGENT

Deliver to Examiner: Tan Nguyen

Fax No. (703) 308-9051

FROM BSTZ:

Attorney: Daniel De Vos
Reg. No.: 37,813
Phone No. (408) 720-8598
Operator: Conny Van Dalen
Page 1 of 14

U.S. PATENT & TRADEMARK OFFICE

Art Unit: 2304
Serial No.: 08/587,731
Filing Date: 01-19-96

Message:

FAX RECEIVED
SEP 30 1997
GROUP 2600

CONFIDENTIALITY NOTE

The documents accompanying this facsimile transmission contain information from the law firm of Blakely Sokoloff Taylor & Zafman which is confidential or privileged. The information is intended to be for the use of the individual or entity named on this transmission sheet. If you are not the intended recipient, be aware that any disclosure, copying, distribution or use of the contents of this facsimile information is prohibited. If you have received this facsimile in error, please notify us by telephone immediately so that we can arrange for the retrieval of the original documents at no cost to you.

IF YOU EXPERIENCE ANY DIFFICULTY IN RECEIVING THE ABOVE PAGES, PLEASE CALL (408) 720-8598 AND ASK FOR THE OPERATOR NAMED ABOVE.

Certificate of Facsimile Transmission

I hereby certify that this correspondence is being transmitted by facsimile to the Patent and Trademarks Office in accordance with 37 CFR § 1.6(d), on 9/11/97

Constance Van Dalen 9-11-97
Signature Date

01576



**UNITED STATES DEPARTMENT OF COMMERCE
Patent and Trademark Office**

Address: COMMISSIONER OF PATENTS AND TRADEMARKS
Washington, D.C. 20231

APPLICATION NO.	FILING DATE	FIRST NAMED INVENTOR	ATTORNEY DOCKET NO.
08/25/97, 731	01/19/96	MARGOLIN	002055.P004

B3M1/1014
BLAKELY SOKOLOFF TAYLOR AND ZAFMAN
12400 WILSHIRE BOULEVARD
7TH FLOOR
LOS ANGELES CA 90025

EXAMINER
NGUYEN, T

ART UNIT PAPER NUMBER
2304 6

DATE MAILED: 10/14/97

Please find below and/or attached an Office communication concerning this application or proceeding.

Commissioner of Patents and Trademarks

01577



UNITED STATES DEPARTMENT OF COMMERCE
Patent and Trademark Office
ASSISTANT SECRETARY AND COMMISSIONER OF PATENTS AND
TRADEMARKS
Washington, D.C. 20231

SERIAL NUMBER	FILING DATE	FIRST NAME APPLICANT	ATTORNEY DOCKET NO.
08/587,731	01/19/96	MARGOLIN	002055.P004

BLAKELY SOKOLOFF TAYLOR AND ZAFMAN
1240 WILSHIRE BOULEVARD
7TH FLOOR
LOS ANGELES, CA 90025

EXAMINER	
TAN Q. NGUYEN	
ART UNIT	PAPER NUMBER
2304	6

DATE MAILED:

Please find below a communication from the Examiner in charge of this application.

Commissioner of Patents and Trademarks.

The communication filed on October 05, 1997 is non-responsive because it fails to include a complete or accurate record of the substance of the September 11, 1997 interview. There is no argument or discussion about the difference between claimed invention and the references cited in the amendment (the amendment contain only the request for canceling claims 39-49).

Applicant is given a **ONE MONTH TIME LIMIT** from the date of this letter, or until the expiration of the period for response set in the last office action, whichever is longer, to complete the response. **NO EXTENSION OF THIS TIME LIMIT MAY BE GRANTED UNDER EITHER 37 CFR 1.136(a) OR (b).**

01578

Any inquiry concerning this communication or earlier communications from the examiner should be directed to examiner Tan Nguyen, whose telephone number is (703) 305-9755. The examiner can normally be reached on Monday-Thursday from 7:30 AM-6:00 PM.

If attempts to reach the examiner by telephone are unsuccessful, the examiner's supervisor, Kevin J. Teska, can be reached on (703) 305-9704.

Any inquiry of a general nature or relating to the status of this application should be directed to the Group receptionist whose telephone number is (703) 305-3900.

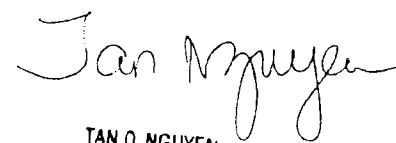

TAN Q. NGUYEN
PATENT EXAMINER
GROUP 2300

TAN NGUYEN
October 10, 1997

01573

10/21/97 TUE 15:01 FAX 4087209387

BST&Z

006

Patent

RECEIVED
OCT 21 1997
GROUP 2300

IN THE UNITED STATES PATENT AND TRADEMARK OFFICE

In re Application of:
Jed Margolin
Serial No. 08/587,731
Filed: January 19, 1996
For: A Method and Apparatus for
Remotely Piloting an Aircraft

Examiner: T. Nguyen
Art Unit: 2304

7/10
feh
10-23

RECEIVED
OCT 21 1997
GROUP 2300

Assistant Commissioner for Patents
Washington, D.C. 20231

AMENDMENT AND REMARK

Sir:

Responsive to the Office Action mailed on July 23, 1997, the Applicant respectfully requests the Examiner to enter the following amendment and to consider the following remark:

AMENDMENT

In the Claims:

Please cancel Claims 39-49, without prejudice.

I hereby certify that this correspondence is being deposited with the United States Postal Service as first class mail with sufficient postage in an envelope addressed to the Commissioner of Patents and Trademarks, Washington, D.C. 20231

on 10/21/97
Date of Deposit

Dawn Roberts
Name of Person Mailing Correspondence

Dawn Roberts
Signature

10/21/97
Date

01580

REMARK

Applicant respectfully requests reconsideration of this application as amended.

35 U.S.C. §102 rejection

The Examiner has rejected claims 1-9, 14-18, 23-32, and 34-45 under 35 U.S.C. §102(b) as being anticipated by Lyons, et al., "Some Navigation Concepts for Remotely Piloted Vehicles."

1. Summary of Lyons

Applicant would like to thank the Examiner for taking the time during the telephone interview to discuss the Lyons reference. Lyons contemplates a remotely piloted vehicle (RPV) transmitting information to a control center (Figure 1), used by the pilot to fly the RPV. To display the position of the RPV to the pilot, the control center provides a "moving map display." As contemplated by Lyons, "the most convenient display mode for the present application is the rolling map or 'passing scene' technique where a new line is added to the top of the display and the scene is shifted slowly downwards" (page 5-3, end of first full paragraph). In particular, Lyons contemplates using film to generate the moving map (Figure 5). The moving map is moved based on dead reckoned positions of the RPV.

As is well known in the art, dead reckoned positions have accumulating error. To correct for this error, Lyons describes two basic concepts: 1) "map matching" (Section 3); and 2) "terrain map correlation" (Section 4). The map matching concept requires that the RPV transmit some kind of image data to the control center. Thus, in addition to the moving map display, the control center shown in Figure 6 has a sensor display (i.e., a display generated from the image data transmitted by the RPV). Lyons contemplates the transmission of two kinds of image data generated by: 1) side looking radar (SLR)

images; and 2) real time forward-looking sensors. When using the SLR system, the SLR generated image data received by the control center allows it to make a downward-looking image. The pilot watches the sensor display (i.e., the display generated based on the transmitted image data) for "likely update features"—landmarks. When the pilot sees a landmark in the sensor display, the pilot presses a transfer button which causes the control center to superimpose the sensor display over the moving map (Figure 5). The pilot then adjusts the moving map so that it matches the overlaid sensor display image and presses an accept button. By adjusting the moving map in this manner, the dead reckoned position of the RPV is updated in an attempt to remove the error associated with the calculation of dead reckoned positions (Page 5-3, second, third, and fourth full paragraphs). The simulated SLR/map update system is illustrated in Figures 7A and 7B.

Having described the SLR-based map matching technique, the real time forward-looking sensor systems will now be described. Lyons describes basically two systems for updating dead reckoned RPV positions on a moving map using only real time forward-looking sensors: 1) an anamorphic projection system (page 5-3, fifth full paragraph; figure 8); and 2) a HUD based system (page 5-3, sixth full paragraph; figure 9). Similar to the SLR based system, the anamorphic projection system requires the pilot to watch the sensor display (i.e., the image generated from the transmitted data) for landmarks, press a button which superimposes the transmitted image on the moving map, adjust the moving map, and press an accept button. As described in Lyons, in order to superimpose the forward-looking transmitted image on the two-dimensional/top-down moving map image, the forward-looking image is transformed using anamorphic projection. Lyons goes on to describe various problems with the anamorphic projection technique, and then describes the HUD based system.

In the HUD based system, the pilot is presented with two images: 1) the moving map display (see left-hand image of Figure 9); and 2) the sensor display generated from the image data transmitted from the real time forward-looking sensor on the RPV. The HUD technology is used to allow the pilot to mark landmarks on the forward-looking sensor based image. These HUD markings are then superimposed on the moving map, and the pilot makes the necessary adjustments to the moving map (page 5-3, sixth full paragraph).

In summary, the map matching techniques use the following: 1) the transmission of image data from the RPV to the control center; 2) a display at the control center which shows an image based on the real time image data received from the RPV; 3) a moving map display that is moved based on the dead reckoned position of the RPV; and 4) some manner of superimposing the sensor image onto the moving map to allow the pilot to update the moving map in an effort to correct the error associated with the dead reckoned positions. Neither the sensor display's image nor the moving map can be equated to the generation of "a three-dimensional projected image" generated based upon "a digital databasc" stored in the control center. The sensor display's image is based on image data transmitted from the RPV, while the moving map contemplated by Lyons is a two-dimensional, top-down view displayed using film (see Figures 5 and 7).

Having described the map matching techniques from Lyons, Applicant will now describe the terrain map correlation technique of Lyons. The terrain map correlation technique described in Lyons is also used for correcting the error in dead reckoned positions shown to the pilot by a two-dimensional moving map. In particular, Lyons states at page 5-3, last paragraph:

Reconisance or forward-looking sensors provide a convenient method of updating the navigation system. However, these sensors required large datalink bandwidth to transmit the video picture to the control center and

hence are vulnerable to ECM... Hence, an alternative method of updating the navigation system is desirable. (emphasis added)

The phrase "updating the navigation system" is used throughout Lyons to refer to the adjustment of a two-dimensional moving map in an effort to correct for error due to dead reckoning.

Rather than requiring the user to actively update the moving map display (i.e., push a button which causes the images to be superimposed, adjusting the moving map, and pushing an accept button), the terrain map correlation technique attempts to adjust the moving map (i.e., correct for the dead reckoned error) without pilot intervention using a laser range measurements and a digital elevation database. In operation, the RPV transmits to the control center a set of laser range measurements (including an altimeter reading). The control center uses dead reckoned positions to both adjust the two-dimensional moving map and to estimate the location of the RPV over a digital database map of elevation points stored in the control center (Figure 10). Based on a calculation of the possible error associated with the dead reckoned positions, a search area is identified in the digital database (Figure 12). A search is then performed within this search area to identify the position that most closely matches the transmitted laser range data. The RPV's position is then updated to the location that best matches the transmitted laser ranges in an attempt to correct the error associated with the dead reckoned positions. The moving map is then automatically adjusted (without pilot intervention) to reflect the updated RPV position.

Thus, the digital database of Lyons (conceptually illustrated in Figure 10) is not used to generate a three-dimensional projected image, but is used to update the two-dimensional moving map in an effort to correct for the error in the dead reckoned positions. In addition to the description in Lyons, further support for the fact that the digital database of Lyons is not used to generate a three-dimensional projected image is

that the image of Figure 10 is generated using square polygons. Square polygons are not plainer, and therefore, typically are not used for generating images. In contrast, triangular polygons are plainer and are typically used for displaying three-dimensional projected images.

2. Lyons Does Not Teach or Make Obvious the Claimed Inventions

In contrast to the teachings of Lyons, claim 1 requires the use of a digital database stored in the control center, and a computer that transforms the database "to provide three-dimensional projected" images based on the position and orientation data received from the RPV. Thus, the digital database of claim 1 is used to generate a three-dimensional projected image for the pilot, whereas: 1) the moving map of Lyons is a two-dimensional image generated using film; and 2) the digital database of Lyons is used for updating the two-dimensional moving map to correct for error associated with the dead reckoned positions, not for display.

Similarly, independent claim 14 requires a database comprising terrain data and a computer "configured to access said terrain data according to "information identifying the remotely piloted craft's position and orientation in three-dimensional space" and configured to transform said terrain data to provide three-dimensional projected image data representing said remotely piloted aircraft's environment." Furthermore, claim 14 requires a display to display the three-dimensional image data.

Independent claim 24 covers a remotely piloted aircraft having a communication system for transmitting the remotely piloted aircraft's position and orientation to a pilot station "for transformation into a three-dimensional projected image of said remotely piloted aircraft's environment according to a database representing real terrestrial terrain using polygons."

Finally, independent method claim 32 requires: 1) "communicating said current position and orientation from said remotely piloted craft to a pilot station;" 2) "accessing a database comprising terrain data that represents real terrestrial terrain as a set of polygons;" 3) "transforming said terrain data into image data representing a simulated three-dimensional view according to the current position and orientation of said remotely piloted aircraft;" and 4) "displaying said three-dimensional view using said image data."

The remaining pending claims are each dependent on one of the allowable base claims 1, 14, 24, and 32. For at least these reasons, Applicant respectfully submits that this rejection has been overcome.

35 U.S.C. §103 rejection, over Lyons, et al. in view of Kanaly (US Patent 4,405,943)

The Examiner has rejected Claims 10, 11, 19, 20, 33, 46-47 under 35 U.S.C. §103 as being obvious over Lyons, et al. ("Lyons") in view of Kanaly (US Patent 4,405,943). Claims 10, 11, 19, 20 and 33 are each dependent on one of the allowable base claims 1, 14, 24, and 32. Claims 46 and 47 have been canceled (without prejudice). For at least this reason, Applicant respectfully submits that this rejection has been overcome with respect to claims 10, 11, 19, 20 and 33.

35 U.S.C. §103 rejection, over Lyons, et al. in view of Thornberg, et al. (US Patent 5,552,983)

The Examiner has rejected Claims 12-13, 21-22, and 48-49 under 35 U.S.C. §103 as being obvious over Lyons, et al. ("Lyons") in view of Thornberg, et al. (US Patent 5,552,983). Claims 12, 13, 21-22 are each dependent on one of the allowable base claims 1 and 14. Claims 48 and 49 have been canceled (without prejudice). For at least this

10/21/97 TUE 15:03 FAX 4087209387

BST&Z

013

reason, Applicant respectfully submits that this rejection has been overcome with respect to claims 12, 13, 21, and 22.

Conclusion

Applicant respectfully submits that the rejections have been overcome by the amendments and remarks, and that the Claims are now in condition for allowance. Accordingly, Applicant respectfully requests the rejections be withdrawn and the Claims as amended be allowed.

Drawing Corrections

The drawings have been objected to by the draftsman. The Applicant will file amended drawings at the time of allowance of the present application.

01587

002055.P004
Serial No. 08/587,731

Patent
Art Unit: 2304

10/21/97 TUE 15:03 FAX 4087208387

BST&Z

014

Invitation for a telephone interview

The Examiner is invited to call the undersigned at 408-720-8598 if there remains any issue with allowance of this case.

Charge our Deposit Account

Please charge any shortage to our Deposit Account No. 02-2666.

Respectfully submitted,

BLAKELY, SOKOLOFF, TAYLOR & ZAFMAN LLP

Date: 10/21, 1997

Daniel M. De Vos
Reg. No. 37,813

12400 Wilshire Boulevard
Seventh Floor
Los Angeles, California 90025-1026
(408) 720-8598

01588

10/21/97 TUE 15:00 FAX 4087209397

BST&Z

001

**BLAKELY SOKOLOFF
TAYLOR &
ZAFMAN**
A Limited Liability
Partnership Including
Law Corporations

1279 Oakmead Pa y
Sunnyvale, California 94086
(408) 720-8598 Telephone
(408) 720-9397 Facsimile

Facsimile Transmittal Sheet

RECEIVED
Date: 10/21/97
OCT 21 1997
GROUP 2300

URGENT

Deliver to: Tan Nguyen

Fax No. (703) 308-5358

<p>FROM BSTZ:</p> <p>From: Daniel De Vos Operator: Dawn Roberts Page 1 of <u>14</u></p>	<p>To Firm: U.S. PATENT AND TRADEMARK OFFICE</p> <p>Phone:</p> <p>Your Ref: Applic. No.: 08/587,731</p> <p>Our Ref: 002055.P004</p> <p>Title: A METHOD AND APPARATUS FOR REMOTELY PILOTING AN AIRCRAFT</p>
--	---

Message:

As agreed, Applicant is resubmitting the response previously faxed on September 11, 1997. To complete the record, following is a brief summary of the reasons (as understood by the Applicant) for resubmitting the response:

On September 11, 1997 applicant faxed 14 pages to the Patent and Trademark Office. These 14 pages included a fax cover page, two copies of a two page Transmittal letter, and a nine page response. In response, Applicant received a paper mailed on September 12, 1997 indicating that applicant's response was non-responsive. In a telephone discussion, it was determined that only one page of applicant's nine page response was actually received.

Sincerely,
Daniel M. De Vos

CONFIDENTIALITY NOTE

The documents accompanying this facsimile transmission contain information from the law firm of Blakely Sokoloff Taylor & Zafman which is confidential or privileged. The information is intended to be for the use of the individual or entity named on this transmission sheet. If you are not the intended recipient, be aware that any disclosure, copying, distribution or use of the contents of this faxed information is prohibited. If you have received this facsimile in error, please notify us by telephone immediately so that we can arrange for the retrieval of the original documents at no cost to you.

IF YOU EXPERIENCE ANY DIFFICULTY IN RECEIVING THE ABOVE PAGES, PLEASE CALL (408) 720-8598 AND ASK FOR THE OPERATOR NAMED ABOVE.

01589

RECEIVED
 OCT 21 1997
 GROUP 2300

Attorney's Docket No.: 002055.P004 Patent
 In re the Application of: Jed Margolin
 Application No.: 08/587,731 (inventor(s))
 Filed: January 19, 1996
 For: A Method and Apparatus for Remotely Piloting an Aircraft
 (title)

ASSISTANT COMMISSIONER FOR PATENTS
 Washington, D.C. 20231

SIR: Transmitted herewith is an Amendment for the above application.

Small entity status of this application under 37 C.F.R. §§ 1.9 and 1.27 has been established by a verified statement previously submitted.

A verified statement to establish small entity status under 37 C.F.R. §§ 1.9 and 1.27 is enclosed. No additional fee is required.

The fee has been calculated as shown below:

	(Col. 1) Claims Remaining After Amd.		(Col. 2) Highest No. Previously Paid For	(Col. 3) Present Extra	SMALL ENTITY		OTHER THAN A SMALL ENTITY	
					Rate	Additional Fee	Rate	Additional Fee
Total Claims	* 38	Minus	** 49	0	x11	\$	x22	\$ 0
Indep. Claims	* 4	Minus	*** 5	0	x40	\$	x80	\$ 0
First Presentation of Multiple Dependent Claim(s)					+130	\$	+260	\$
					Total Add. Fee	\$	Total Add. Fee	\$ 0

- * If the entry in Col. 1 is less than the entry in Col. 2, write "0" in Col. 3.
- ** If the "Highest No. Previously Paid For" IN THIS SPACE is less than 20, write "20" in this space.
- *** If the "Highest No. Previously Paid For" IN THIS SPACE is less than 3, write "3" in this space. The "Highest No. Previously Paid For" (Total or Independent) is the highest number found from the equivalent box in Col. 1 of a prior amendment or the number of claims originally filed.

I hereby certify that this correspondence is being transmitted by facsimile to the United States Patent and Trademark Office in accordance with 37 CFR § 1.6(d), on the date shown below.

Name: Dawn Roberts
 Signature: Dawn Roberts
 Date: 10/21/97

01590

_____ A check in the amount of \$ _____ is attached for presentation of additional claim(s).
_____ Applicant(s) hereby Petition(s) for an Extension of Time of _____ month(s) pursuant to
37 C.F.R. § 1.136(a).

_____ A check for \$ _____ is attached for processing fees under 37 C.F.R. § 1.17.
_____ Please charge my Deposit Account No. ~~02-2666~~ the amount of \$ _____.

A duplicate copy of this sheet is enclosed.

The Commissioner of Patents and Trademarks is hereby authorized to charge payment of the
following fees associated with this communication or credit any overpayment to Deposit Account
No. ~~02-2666~~ (a duplicate copy of this sheet is enclosed):

Any additional filing fees required under 37 C.F.R. § 1.16 for presentation of
extra claims.

Any extension or petition fees under 37 C.F.R. § 1.17.

Date: _____ 10/21, 1997

12400 Wilshire Boulevard
Seventh Floor
Los Angeles, California 90025
(408) 720-8598

BLAKELY SOKOLOFF TAYLOR & ZAFMAN LLP

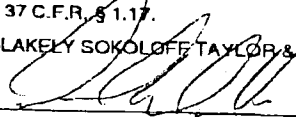
Daniel M. De Vos

Reg. No. 37,813

01591

RECEIVED
OCT 21 1997
GROUP 2300
Patent

Attorney's Docket No.: 002055.P004
 In re the Application of: Jed Margolin (Inventor(s))
 Application No.: 08/587,731
 Filed: January 18, 1996
 For: A Method and Apparatus for Remotely Piloting an Aircraft

 _____ (title)

ASSISTANT COMMISSIONER FOR PATENTS
 Washington, D.C. 20231

SIR: Transmitted herewith is an Amendment for the above application.

Small entity status of this application under 37 C.F.R. §§ 1.9 and 1.27 has been established by a verified statement previously submitted.
 A verified statement to establish small entity status under 37 C.F.R. §§ 1.9 and 1.27 is enclosed.
 No additional fee is required.

The fee has been calculated as shown below:

	(Col. 1) Claims Remaining After Amd.		(Col. 2) Highest No. Previously Paid For	(Col. 3) Present Extra
Total Claims	* 38	Minus **	49	0
Indep. Claims	* 4	Minus ***	5	0
<input type="checkbox"/> First Presentation of Multiple Dependent Claim(s)				

SMALL ENTITY	
Rate	Additional Fee
x11	\$
x40	\$
+130	\$
Total Add. Fee	\$

OTHER THAN A SMALL ENTITY	
Rate	Additional Fee
x22	\$ 0
x80	\$ 0
+260	\$
Total Add. Fee	\$ 0

- * If the entry in Col. 1 is less than the entry in Col. 2, write "0" in Col. 3.
- ** If the "Highest No. Previously Paid For" IN THIS SPACE is less than 20, write "20" in this space.
- *** If the "Highest No. Previously Paid For" IN THIS SPACE is less than 3, write "3" in this space. The "Highest No. Previously Paid For" (Total or Independent) is the highest number found from the equivalent box in Col. 1 of a prior amendment or the number of claims originally filed.

I hereby certify that this correspondence is being transmitted by facsimile to the United States Patent and Trademark Office in accordance with 37 CFR § 1.6(d), on the date shown below.

Name: Dana Roberts
 Signature: Dana Roberts
 Date: 10/21/97

01592

- A check in the amount of \$ _____ is attached for presentation of additional claim(s).
- Applicant(s) hereby Petition(s) for an Extension of Time of _____ month(s) pursuant to 37 C.F.R. § 1.136(a).
- A check for \$ _____ is attached for processing fees under 37 C.F.R. § 1.17.
- Please charge my Deposit Account No. 02-2666 the amount of \$ _____.
- A duplicate copy of this sheet is enclosed.
- The Commissioner of Patents and Trademarks is hereby authorized to charge payment of the following fees associated with this communication or credit any overpayment to Deposit Account No. 02-2666 (a duplicate copy of this sheet is enclosed):
 - Any additional filing fees required under 37 C.F.R. § 1.16 for presentation of extra claims.
 - Any extension or petition fees under 37 C.F.R. § 1.17.

Date: 10/21, 1997

12400 Wilshire Boulevard
Seventh Floor
Los Angeles, California 90025
(408) 720-8598

BLAKE, BOGGS, GLENN, GRAY & ZAFMAN LLP

ORIGINAL SIGNED BY

[Signature]

Daniel M. De Vos

Reg. No. 37,813

01593

08/587,731



**UNITED STATES DEPARTMENT OF COMMERCE
Patent and Trademark Office**

Address: COMMISSIONER OF PATENTS AND TRADEMARKS
Washington, D.C. 20231

APPLICATION NUMBER	FILING DATE	FIRST NAMED APPLICANT	ATTORNEY DOCKET NO.
--------------------	-------------	-----------------------	---------------------

08/587,731	01/19/96	MARGOLIN	J 002055.P004
------------	----------	----------	---------------

LM21/1128
BLAKELY SOKOLOFF TAYLOR AND ZAFMAN
12400 WILSHIRE BOULEVARD
7TH FLOOR
LOS ANGELES CA 90025

EXAMINER

ART UNIT	PAPER NUMBER
----------	--------------

2763

8

DATE MAILED: 11/28/97

This is a communication from the examiner in charge of your application.
COMMISSIONER OF PATENTS AND TRADEMARKS

OFFICE ACTION SUMMARY

Responsive to communication(s) filed on 10/21/1997

- This action is FINAL.
- Since this application is in condition for allowance except for formal matters, prosecution as to the merits is closed in accordance with the practice under *Ex parte Quayle*, 1935 D.C. 11; 453 O.G. 213.

A shortened statutory period for response to this action is set to expire 3 month(s), or thirty days, whichever is longer, from the mailing date of this communication. Failure to respond within the period for response will cause the application to become abandoned. (35 U.S.C. § 133). Extensions of time may be obtained under the provisions of 37 CFR 1.136(a).

Disposition of Claims

- Claim(s) 1-38 are pending in the application.
- Of the above, claim(s) _____ is/are withdrawn from consideration.
- Claim(s) _____ is/are allowed.
- Claim(s) 1-38 is/are rejected.
- Claim(s) _____ is/are objected to.
- Claims _____ are subject to restriction or election requirement.

Application Papers

- See the attached Notice of Draftsperson's Patent Drawing Review, PTO-948.
- The drawing(s) filed on _____ is/are objected to by the Examiner.
- The proposed drawing correction, filed on _____ is approved disapproved.
- The specification is objected to by the Examiner.
- The oath or declaration is objected to by the Examiner.

Priority under 35 U.S.C. § 119

- Acknowledgement is made of a claim for foreign priority under 35 U.S.C. § 119(a)-(d).
- All Some* None of the CERTIFIED copies of the priority documents have been received.
- received in Application No. (Series Code/Serial Number) _____
- received in this national stage application from the International Bureau (PCT Rule 17.2(a)).

*Certified copies not received: _____

- Acknowledgement is made of a claim for domestic priority under 35 U.S.C. § 119(e).

Attachment(s)

- Notice of Reference Cited, PTO-892
- Information Disclosure Statement(s), PTO-1449, Paper No(s) _____
- Interview Summary, PTO-413
- Notice of Draftsperson's Patent Drawing Review, PTO-948
- Notice of Informal Patent Application, PTO-152

01594

-- SEE OFFICE ACTION ON THE FOLLOWING PAGES --

Serial No.: 08/587,731
Art Unit: 2304

2

DETAILED ACTION

Notice to Applicant(s)

1. This office action is responsive to the amendment filed on October 21, 1997. As per request, claims 39-49 have been canceled. Thus, claims 1-38 are pending.

Drawings

2. The drawings are objected to under 37 CFR § 1.84 for the reasons set forth by the draftsman. See attached PTO-948 form for details. Correction is required. However, correction of the noted defect can be deferred until the application is allowed by the examiner.

Claim Rejections - 35 USC § 103

3. The following is a quotation of 35 U.S.C. 103(a) which forms the basis for all obviousness rejections set forth in this Office action:
 - (a) A patent may not be obtained though the invention is not identically disclosed or described as set forth in section 102 of this title, if the differences between the subject matter sought to be patented and the prior art are such that the subject matter as a whole would have been obvious at the time the invention was made

01595

Serial No.: 08/587,731
Art Unit: 2304

3

to a person having ordinary skill in the art to which said subject matter pertains.

Patentability shall not be negated by the manner in which the invention was made.

4. Claims 1-9, 14-18, 23-32, and 34-38 rejected under 35 U.S.C. § 103(a) as being unpatentable over Lyons et al. (an article entitled "Some Navigation Concepts For Remotely Piloted Vehicles", AGUARD Conference Proceedings No. 176 on Medium Accuracy Low Cost Navigation, September 1975, pages 5-1 to 5-15) in view of Wysocki et al. (5,381,338) or Fant (4,835,532) or Beckwith et al. (4,660,157).

a. With respect to claims 1, 2, and 14, Lyons et al. disclose the invention as claimed (see at least the abstract) including a remotely piloted aircraft (see figure 8, RPV), a communications system for communicating flight data between a computer and said remotely piloted aircraft, said flight data including said remotely piloted aircraft's position and orientation, said flight data also including flight control information for controlling said remotely piloted aircraft (see page 5-2, section Radio Navigation Using a Data Link, and figure 6 and the related text), a digital database comprising terrain data (see pages 5-3 and 5-4, section Terrain Map Correlation; and figure 8). Lyons et al. further disclose that the computer accesses said terrain data according to said remotely piloted aircraft's position and to transform said terrain data to provide a projected image data according to said remotely piloted aircraft's orientation; a display

01596

Serial No.: 08/587,731
Art Unit: 2304

4

for displaying said projected image data (see page 5-4, third paragraph, and figure 8), and a remote flight control coupled to said computer for inputting said flight control information (see figure 6).

Lyon et al. do not explicitly disclose that the computer produce a three dimensional image data from the digital database and the navigation information. However such feature is well known at the time the invention was made (for examples, see figure 1 and the related text in Wysocki et al.; see figures 1, 3 and the related text in Fant; or see figures 1, 4 and the related text in Beckwith et al.). It would have been obvious to one of ordinary skill in the art at the time the invention was made to incorporate the teaching of either Wysocki et al., Fant, or Beckwith et al. into the system of Lyon et al. in order to improve the system with the enhanced capability of displaying three-dimensional image of the remoted aircraft over the terrain data.

b. With respect to claim 3, Lyons et al. disclose that the flight data communicated between said remotely piloted aircraft and said computer is secured (see page 5-2, first paragraph of the Radio Navigation Using Data Link section).

c. With respect to claims 4, 5, 7, and 15, Lyons et al. disclose that said remotely piloted aircraft further comprises a infra red sensor image (video camera) and means for communicating and displaying video data representing images captured by the sensor image (see page 5-3, section Map Matching, and figure 8).

01597

Serial No.: 08/587,731
Art Unit: 2304

6

24-31. Therefore, claims 32 and 34-38 are rejected for the same rationales set forth for claims 24-31.

5. Claims 10, 11, 19, 20, and 33 are rejected under 35 U.S.C. 103(a) as being unpatentable over Lyons et al., Wysocki et al. or Fant or Beckwith et al. as applied to claims 1-9, 14-18, 23-32, and 34-38, and further in view of Kanaly (4,405,943).

Lyons et al. disclose the claimed invention as discussed above except for the determination of a delay time for communicating said flight data between said computer and said remotely piloted aircraft, and adjusting the sensitivity of said set of one or more remote flight controls based on said delay time. However, Kanaly does suggest delay time for communicating between the ground station and the remote airborne into account of controlling the remote airborne (see at least column 3, lines 15-24, and column 8, line 54 to column 9, line 6). It would have been obvious to incorporate the teaching of Kanaly into the system of Lyons et al. in order to improve the system with the enhanced capability of providing more accurate the remote flight controls to the remoted vehicle and receiving the accurate position and heading data of the vehicle from the remoted vehicle.

6. Claims 12-13, and 21-22 are rejected under 35 U.S.C. 103(a) as being

01598

Serial No.: 08/587,731
Art Unit: 2304

7

unpatentable over Lyons et al., Wysocki et al. or Fant or Beckwith et al. as applied to claims 1-9, 14-18, 23-32, and 34-38 above, and further in view of Thornberg et al. (5,552,983).

Lyons et al. disclose the claimed invention as discussed above except that the remote flight controls allows for inputting absolute pitch and roll angles. However, such feature is well known in the art at the time the invention was made. For example, Thornberg et al. suggest a variable referenced control system for remotely operated vehicles which includes means for inputting absolute pitch and roll angles for remotely control the unmanned aerial vehicle (see at least figures 5 and 6). It would have been obvious to one of ordinary skill in the art at the time the invention was made to incorporate the teaching of Thornberg et al. into the system of Lyons et al. in order to input the pitch and roll control signals as the flight control signals for remotely control the vehicle.

7. All claims are rejected.

Remarks

8. Applicant's arguments filed on October 27, 1997 have been fully considered and they are deemed to be persuasive. However, upon the updated search, the new ground of rejections has been set forth as above.

01509

Serial No.: 08/587,731
Art Unit: 2304

8

9. Any inquiry concerning this communication or earlier communications from the examiner should be directed to examiner Tan Nguyen, whose telephone number is (703) 305-9755. The examiner can normally be reached on Monday-Thursday from 7:30 AM-5:00 PM. The examiner can also be reached on alternate Fridays.

If attempts to reach the examiner by telephone are unsuccessful, the examiner's supervisor, Kevin J. Teska, can be reached on (703) 305-9704.

Any inquiry of a general nature or relating to the status of this application should be directed to the Group receptionist whose telephone number is (703) 305-3900.

Any response to this action should be mailed to:

Commissioner of Patents and Trademarks
Washington, D.C. 20231

or faxed to:

(703) 308-9051, (for formal communications intended for entry)

Or:

(703) 308-5357 (for informal or draft communications, please label "PROPOSED" or "DRAFT")

Hand-delivered responses should be brought to Crystal Park II, 2121 Crystal Drive, Arlington, VA., Sixth Floor (Receptionist).

/tqn
November 20, 1997

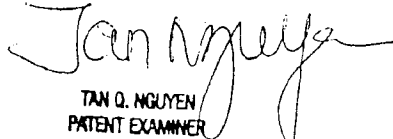
TAN Q. NGUYEN
PATENT EXAMINER

01600

Attorney's Docket No. 2055.P004

PATENT

IN THE UNITED STATES PATENT AND TRADEMARK OFFICE



In re Application of:
Jed Margolin
Application No. 08/587,731
Filed: January 19, 1996
For: A Method and Apparatus for Remotely Piloting an Aircraft

Examiner: T. Nguyen
Art Unit: 3614

#9/IDS
4/1/98

Assistant Commissioner for Patents
Washington, D.C. 20231

RECEIVED
MAR 20 PM 5:42
COMM-F 2050

INFORMATION DISCLOSURE STATEMENT

Sir:

Enclosed is a copy of Information Disclosure Citation Form PTO-1449 together with copies of the documents cited on that form. It is respectfully requested that the cited documents be considered and that the enclosed copy of Information Disclosure Citation Form PTO-1449 be initialed by the Examiner to indicate such consideration and a copy thereof returned to applicant(s).

Pursuant to 37 C.F.R. § 1.97, the submission of this Information Disclosure Statement is not to be construed as a representation that a search has been made and is not to be construed as an admission that the information cited in this statement is material to patentability.

Pursuant to 37 C.F.R. § 1.97, this Information Disclosure Statement is being submitted under one of the following (as indicated by an "X" to the left of

FIRST CLASS CERTIFICATE OF MAILING

I hereby certify that this correspondence is being deposited with the United States Postal Service as first class mail with sufficient postage in an envelope addressed to the Assistant Commissioner for Patents, Washington, D.C. 20231 on February 27, 1998
(Date of Deposit)

Conny Van Dalen
Name of Person Mailing Correspondence

Conny VanDalen
Signature

2-27-98
Date

01601

the appropriate paragraph):

- 37 C.F.R. §1.97(b).
- 37 C.F.R. §1.97(c). If so, then enclosed with this Information Disclosure Statement is one of the following:
- A certification pursuant to 37 C.F.R. §1.97(e) or
- A check for \$240.00 for the fee under 37 C.F.R. § 1.17(p).
- 37 C.F.R. §1.97(d). If so, then enclosed with this Information Disclosure Statement are the following:
- (1) A certification pursuant to 37 C.F.R. §1.97(e);
 - (2) A petition requesting consideration of the Information Disclosure Statement; and
 - (3) A check for \$_____ for the fee under 37 C.F.R. §1.17(i) for submission of the Information Disclosure Statement.

If there are any additional charges, please charge Deposit Account No. 02-2666.

Respectfully submitted,

BLAKELY, SOKOLOFF, TAYLOR & ZAFMAN LLP

Dated: 2/27, 1998

ORIGINAL SIGNED BY

DmD
Daniel M. De Vos
Reg. No. 37,813

12400 Wilshire Blvd.
Seventh Floor
Los Angeles, CA 90025-1026
(408) 720-8598

GRIPEN LIKELY TO FLY AGAIN SOON

CAROLE A. SHIFRIN/LONDON

A preliminary report on the crash of the Swedish JAS 39 Gripen fighter earlier this month has put blame on the flight control system's high amplification of stick commands combined with the pilot's "large, rapid stick movements."

"This led to the stability margin being exceeded and the aircraft entering a stall," Sweden's accident investigation board said. The panel said a contributing factor was the late display of the aircraft's "STYRSAK" flight attitude warning, which gave the pilot too little time to react.

The board said action should be taken to eliminate the risk of pilot-induced oscillation in the aircraft's envelope. After this has been implemented and verified, the board said it saw no safety reason why flights should not be resumed.

The preliminary report of the Aug. 8 accident ruled out a system or design deficiency in the Gripen's advanced flight control system, which had caused the crash of the first prototype in February, 1989. A finding of a serious design fault would have caused a major reevaluation of the multirole Gripen (AW&ST Aug. 16, p. 78).

The problem will be relatively easy to correct and the aircraft should be flying again within the next three to five weeks,

Swedish air force officials said.

The preliminary report on the crash, which occurred during an air display over central Stockholm, said that Saab Military Aircraft test pilot Lars Radstrom had entered a low-speed turn at a 280-meters (919-ft.) altitude with lit afterburner and a speed of 285 km./hr. (154 kt.). During the left turn, the aircraft's angle of bank was about 65 deg., loading about 2g and angle of attack about 21 deg.

When leaving the turn, the pilot applied an almost maximum movement of the control stick to the right as he was pushing it forward to assume level flight. The large stick movement caused the aircraft to roll over to the right while the angle of attack decreased. Attempting to level quickly, Radstrom then applied a large movement of the stick to the left while continuing to push forward to lower the nose.

The elevons moved with maximum speed, changing the aircraft's flying characteristics and reducing its stability margin. This is when the control system sent a signal to the aircraft's STYRSAK warning system that the maximum rate of elevon deflection had been reached. The aircraft responded to the pilot's command with a roll to the left combined with a nose-up movement.

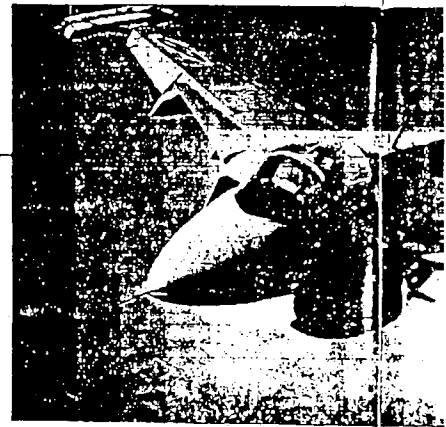

To correct these movements, Radstrom moved the stick almost all the way to the right and somewhat forward. The aircraft then rolled to the right with an angle of bank of about 35 deg. in combination with a nose-down movement to -7 deg. angle of pitch. Radstrom then moved the stick rapidly backwards and to the left to lift the nose at the same time that the aircraft's stabilizing functions attempted to lift the nose.

"This caused the nose-up movement to be amplified so much that the stabilizing effect of the elevons was insufficient, whereupon the aircraft went into a superstall and became uncontrollable," the preliminary report said.

The STYRSAK warning to the pilot that

TAIWAN INDUSTRY SEEKS MAJOR GROWTH

MICHAEL MECHAM, TAIPEI, TAIWAN

Taiwan aerospace companies, which now have annual military and civil aerospace programs valued at some \$1 billion, want to grow six times as large by the end of the decade through joint-venture work with foreign partners.

That theme was stressed last week at the Taipei Aerospace Technology Exhibition, which attracted 230 exhibitors from 15 nations—60% more than in its first outing two years ago. The exhibition is proving such a draw that organizers are considering the inclusion of flying displays for 1995.

THE REPUBLIC OF CHINA'S IDF fighter was shown only in a full-scale mockup version inside the exhibition hall. But two of the first production models—single- and twin-seat versions—were publicly

displayed for the first time at the nearby Shun-Shan air base. They appeared alongside the AT-3 advanced jet trainer, shown in a single-seat light fighter configuration and as a twin-seat trainer. Taiwan Aerospace hopes to compete the AT-3 in the U. S. Joint Primary Aircraft Training System competition.

By government estimate, Taiwan's annual aerospace growth rate will be 20% through 1996. Achieving \$6 billion in annual maintenance and production work by 2000 would be even more spectacular. But David R. C. Chu, director of the Committee for Aviation and Space Industry Development (CASID), said it should be possible, using the pending British Aerospace/Taiwan Aerospace agreement to jointly produce the RJ re-

gional commuter jet and the pending F-16 and Mirage 2000-5 fighter acquisitions as springboards.

CASID, the government agency charged with promoting Taiwan aerospace development, has strong backing from President Lee Teng-hui. In an address prepared for the exhibition, Lee emphasized that of the eight key industrial technologies identified in his national economic stimulus package, seven are applicable to aerospace.

CHU DESCRIBED TAIWAN'S goal as being an Asian aerospace "hub" in league with foreign partners rather than any grander scheme of acquiring technology now in hopes of setting off later on an independent course.

"Our goal is to be the best partner of the best companies," he said.

Neither Dassault nor ROC Defense Ministry officials will discuss details of the pending sale of Mirage 2000-5s. Of particular interest is what type of offset agreement might be achieved for the fighter.



First JAS 39 delivered to the Swedish air force crashed during a flight display in Stockholm.

he was beginning to saturate the control system was displayed 1 sec. after the rapid stick movement. Just 6.2 sec. elapsed from the time the pilot gave the command to leave the turn until he ejected.

The delay in display of the STYRSÅK warning meant the pilot did not have a chance to react, the report said. The low altitude did not give him the opportunity to take action to regain control of the aircraft, and his decision to eject was correct, it concluded.

Officials said the problem that caused the accident had been identified during the development program. But the risk of the situation occurring in flight was considered "negligible."

The model is most likely to be the agreement now being implemented with Lockheed for the F-16. It calls for offsets worth 10% of the \$6-billion contract for 150 aircraft.

LOCKHEED OFFICIALS are expected to begin canvassing 49 Taiwan factories this week to select candidates for offset work.

Chu said Taiwan does not have priorities for the offsets. Maintenance and re-supply are expected to be the major elements, although original parts supply could be an element in later block deliveries, he said.

Most important is to hear Lockheed's analysis of the local industry, he said. "We have little experience, so we have to rely on Lockheed's expertise," he said.

Taiwan's metallurgy industries are expected to provide the core for the offsets, which means air frame and perhaps some engine parts will be produced. That is because Taiwan should be able to achieve certification in airframe parts faster than in military electronics, Chu said.



BREITLING

1884

INSTRUMENTS FOR PROFESSIONALS



CHRONO LONGITUDE
Designed for globe-trotting travellers, this mechanical auto-winding chronograph permanently displays a second time zone by an auxiliary hour hand, distinct from the local-time hand, under which it can be retracted. Pronounced legibility in the dark. Screw-locked crown. Water-resistant to 50 m. Rotating bezel with wind rose.

BREITLING WORLD CUP OF AEROBATICS 1993

- BREITLING MASTERS OF FRANCE, Paris Air Show, June 11-13
- EUROPEAN AEROBATICS CHAMPIONSHIPS, Grosseto, Italy, June 16-27
- EAA FLY-IN CONVENTION, Oshkosh USA, August 2-3
- BREITLING MASTERS OF SWITZERLAND, Bex, August 26-29
- BREITLING MASTERS OF GERMANY, Berlin, September 2-5
- BREITLING MASTERS OF USA, Pompano Beach, November 18-21

BREITLING MONTRES SA
P.O. Box 1132
SWITZERLAND - 2540 GRENCHEN

Tel.: 65/51 11 31
Fax: 65/53 10 09

BREITLING USA INC.
P.O. Box 110215
STAMFORD, CT 06911-0215

Tel.: 203/327 1411
Fax: 203/327 2537

Circle 73 on Reader Card

01605

002055.P004

Patent

IN THE UNITED STATES PATENT AND TRADEMARK OFFICE

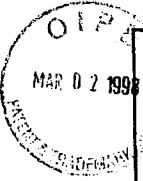

In re Application of:
 Jed Margolin
 Serial No. 08/587,731
 Filed: January 19, 1996
 For: A Method and Apparatus for
 Remotely Piloting an Aircraft

Examiner: T. Nguyen
Art Unit: 2304

#10/B
4/1/98

RECEIVED
MAR 20 PM 5:42
COMM-FBI

Assistant Commissioner for Patents
Washington, D.C. 20231

AMENDMENT AND REMARK

Sir:

Responsive to the Office Action mailed on November 28, 1997, the Applicant respectfully requests the Examiner to enter the following amendment and to consider the following remark:

AMENDMENT

In the Specification:

On page 3, line 22, please replace "many" with --may--.

On page 3, line 23, please replace "cameras" with --camera--.

In the Claims:

Please cancel claims 10, 11, 19 and 20, without prejudice.

Please amend the claims as follows:

FIRST CLASS CERTIFICATE OF MAILING

I hereby certify that this correspondence is being deposited with the United States Postal Service as first class mail with sufficient postage in an envelope addressed to the Assistant Commissioner for Patents, Washington, D.C. 20231 on February 27, 1998

(Date of Deposit)

Conny Van Dalen

Name of Person Mailing Correspondence

Conny Van Dalen

Signature

2-27-98

Date

01605

B/

1 1. (Once Amended) A system comprising:
2 a remotely piloted aircraft including,
3 a position determining system to locate said remotely piloted aircraft's
4 position in three dimensions; and
5 an orientation determining system for determining said remotely piloted
6 aircraft's orientation in three dimensional space;
7 a communications system for communicating flight data between a computer and
8 said remotely piloted aircraft, said flight data including said remotely piloted aircraft's
9 position and orientation, said flight data also including flight control information for
10 controlling said remotely piloted aircraft;
11 a digital database comprising terrain data;
12 said computer to access said terrain data according to said remotely piloted
13 aircraft's position and to transform said terrain data to provide three dimensional
14 projected image data according to said remotely piloted aircraft's orientation;
15 a display for displaying said three dimensional projected image data; and
16 a set of one or more remote flight controls coupled to said computer for inputting
17 said flight control information, wherein said computer is also for determining a delay
18 time for communicating said flight data between said computer and said remotely piloted
19 aircraft, and wherein said computer adjusts the sensitivity of said set of one or more
20 remote flight controls based on said delay time.

1 2. (Once Amended) The system of claim 1, wherein:
2 said remotely piloted aircraft [including:] includes a device for capturing image
3 data; and
4 said system operates in at least a first mode in which said image data is not
5 transmitted from said remotely piloted aircraft to said computer at a sufficient data rate to
6 allow for real time piloting of the remotely piloted aircraft

B1

7 [a position determining system for locating said remotely piloted aircraft's
8 position in three dimensions; and
9 an orientation determining system for determining said remotely piloted
10 aircraft's orientation in three dimensional space].

B2

1 ~~13~~ (Once Amended) A station for flying a remotely piloted aircraft that is real or
2 simulated comprising:
3 a database comprising terrain data;
4 a set of remote flight controls for inputting flight control information;
5 a computer having a communications unit configured to receive status
6 information identifying said remotely piloted aircraft's position and orientation in three
7 dimensional space, said computer configured to access said terrain data according to said
8 status information and configured to transform said terrain data to provide three
9 dimensional projected image data representing said remotely piloted aircraft's
10 environment, said computer coupled to said set of remote flight controls and said
11 communications unit for transmitting said flight control information to control said
12 remotely piloted aircraft, said computer also to determine a delay time for
13 communicating said flight control information between said computer and said remotely
14 piloted aircraft, and said computer to adjust the sensitivity of said set of remote flight
15 controls based on said delay time; and
16 a display configured to display said three dimensional projected image data.

B3

~~1 24 (Once Amended) A remotely piloted aircraft comprising:
2 a position determining system to locate said remotely piloted aircraft's position in
3 three dimensions;
4 an orientation determining system to determine said remotely piloted aircraft's
5 orientation in three dimensional space;~~

01608

6 ~~a communications system for transmitting status information, including said~~
7 ~~remotely piloted aircraft's position and orientation, to a pilot station for transformation~~
8 ~~into a three dimensional projected image of said remotely piloted aircraft's environment~~
9 ~~according to a database representing real terrestrial terrain using polygons, said~~
10 ~~communications system also for receiving from said pilot station flight control~~
11 ~~information; and~~
12 ~~a control system for adjusting said remotely piloted aircraft's flight in response to~~
13 ~~said flight control information.~~

Please add the following new claims:

1 ~~10~~ 50. (New) The system of claim 1, wherein:
2 said remotely piloted aircraft includes a device for capturing image data; and
3 said system operates in at least a first mode in which said image data is not transmitted
4 from said remotely piloted craft to said computer but stored in said remotely piloted
5 aircraft.

1 ~~51.~~ (New) The remotely piloted aircraft of claim 24 further comprising:
2 a device for capturing image data, wherein said remotely piloted aircraft operates
3 in at least a first mode in which said image data is not transmitted from said remotely
4 piloted aircraft to said computer at a sufficient data rate to allow for real time piloting of
5 the remotely piloted aircraft.

1 52. (New) The method of claim 32 further comprising the step of:
2 generating said flight control information responsive to said simulated three
3 dimensional view and without any image transmitted from said remotely piloted aircraft.

BM
1 53. ~~(New) The method of claim 34, wherein said step of generating said flight control~~
2 ~~information in response to manual manipulations of the set of manual flight controls on~~
3 ~~said pilot station includes the step of:~~
4 ~~receiving input representing a current position of a directional control; and~~
5 ~~interpreting said current position relative to the horizon, rather than a rate of~~
6 ~~rotation.~~

REMARK

Applicant respectfully requests reconsideration of this application as amended.

35 U.S.C. §103 rejection, over Lyons in view of Wysoki or Fant or Beckwith

The Examiner has rejected Claims 1-9, 14-18, 23-32, and 34-38 under 35 U.S.C. §103 as being obvious over Lyons in view of Wysoki or Fant or Beckwith.

According to M.P.E.P. § 2142, "[t]o establish a primary facia case of obviousness, ... the prior art reference (or references when combined) must teach or suggest all the claim limitations. The teaching or suggestion to make the claim combination and the reasonable expectation of success must both be found in the prior art, and not based on applicant's disclosure." (emphasis added).

CLAIMS 1 and 14

Claim 1 has been amended to include the limitations of claims 2, 10 and 11. Similarly Claim 14 has been amended to include the limitations of claims 19 and 20. Thus, Claims 1 and 14 are discussed under the next rejection directed to claims 10, 11, 19, and 20.

CLAIMS 24 AND 32

1. The Office Action Misdescribes Lyons

The office action agrees that Lyons does not teach the generation of "three dimensional image data from the digital database and the navigation information." However, Lyons fails to teach more than just the generation of the 3D image.

Lyons teaches a pilot station that uses dead reckoning to estimate the location of the RPV. As is well known in the art, dead reckoned positions have accumulating error. To correct for this error, the RPV transmits some information to the pilot station. The information transmitted depends on the approach of which Lyons describes two:

- 1) The transmission of video or radar image data from the RPV to the pilot station. For the video and radar image data (Section 3, including Figure 8), the pilot station provides a two dimensional moving map on which the pilot station indicates the dead reckoned position. At various intervals, the pilot must use the video or radar image to correct the dead reckoned position (This is what Figure 8 shows).
- 2) The transmission of laser measurements from the RPV to the pilot station. For the laser measurements (Section 4, Figure 10-12), the pilot station includes a database. The pilot station identifies a search area in the database based on the dead reckoned position - where the current dead reckoned position is the center of the search area ("expected RPV position" in Figure 12) and the search area represents the locations the RPV could be due to the accumulating error in the current dead reckoned position. The pilot station then compares the laser measurement for various position in the search area in an effort to locate the correct position of the RPV. Once the database has been used to locate the correct position of the RPV, the pilot station indicates the RPVs actual position on the 2D moving map (this map is not generated based on the database).

01611

One advantage of the laser system being that the error in the dead reckoned position is automatically corrected using the laser and database, whereas the video and radar image data system requires user intervention to update. Another advantage of the laser system is that the laser data requires less bandwidth than the video or radar image data. For a further description of Lyons, see footnote ¹.

In summary, the Lyons reference teaches various techniques for updating the dead reckoned position of remotely piloted aircraft on a two dimensional moving map display available to the pilot. In particular, Lyons contemplates a RPV transmitting information to a control center (Figure 1). The control center is used by the pilot to fly the RPV. To display the position of the RPV to the pilot, the control center provides a "moving map display." As contemplated by Lyons, "the most convenient display mode for the present application is the rolling map or 'passing scene' technique where a new line is added to the top of the display and the scene is shifted slowly downwards" (page 5-3, end of first full paragraph). In particular, Lyons contemplates using film to generate the moving map (Figure 5). The moving map is moved based on the dead reckoned positions of the RPV.

As is well known in the art, dead reckoned positions have accumulating error. To adjust for this error, Lyons describes two basic concepts: 1) map matching (Section 3); and 2) terrain map correlation (Section 4). The map matching concept requires that the RPV transmit some kind of image data to the control center. In Figure 6, the control center is shown having the moving map display and the sensor display (i.e., a display generated from the image data transmitted by the RPV). Lyons contemplates the transmission of two kinds of image data: 1) side looking radar (SLR); and 2) real time forward-looking sensors. When using the SLR system, the SLR generated image data received by the control center allows it to make a downward-looking image. The pilot watches the sensor display (i.e., the display generated based on the transmitted image data) for "likely update features"—landmarks. When the pilot sees a landmark in the sensor display, the pilot presses a transfer button which causes the control center to superimpose the sensor display over the moving map (Figure 5). The pilot then adjusts the moving map so that it matches the overlaid sensor display image and presses an accept button. By adjusting the moving map in this manner, the dead reckoned position of the RPV is updated in an attempt to remove the error associated with the calculation of dead reckoned positions (Page 5-3, second, third, and fourth full paragraphs). The simulated SLR/map update system is illustrated in Figures 7A and 7B.

Having described the SLR-based map matching technique, the real time forward-looking sensor technique will now be described. Lyons describes basically two techniques of updating dead reckoned RPV positions on a moving map using only real time forward-looking sensors: 1) an anamorphic projection technique (page 5-3, fifth full paragraph; figure 8); and 2) a HUD based technique (page 5-3, sixth full paragraph; figure 9). Similar to the SLR based technique, the anamorphic projection technique requires the pilot to watch the sensor display (i.e., the image generated from the transmitted data) for landmarks, press a button which superimposes the transmitted image on the moving map, adjust the moving map, and press an accept button. As described in Lyons, in order to superimpose the forward-looking transmitted image on the moving map, the forward-looking image is transformed using anamorphic projection. Lyons goes on to describe various problems with the anamorphic projection technique, and then describes the HUD based technique.

In the HUD based technique, the pilot is presented with two images: 1) the moving map display (see left-hand image of Figure 9); and 2) the sensor display generated from the image data transmitted from the real time forward-looking sensor on the RPV. The HUD technology is used to allow the pilot to mark landmarks on the forward-looking sensor based image. These HUD markings are then superimposed on the moving map, and the pilot makes the necessary adjustments to the moving map (page 5-3, sixth full paragraph).

In summary, the map matching techniques use the following: 1) the transmission of image data from the RPV to the control center; 2) a display at the control center which shows an image based on the real time image data received from the RPV; 3) a moving map display that is moved based on the dead reckoned position of the RPV; and 4) some manner of superimposing the sensor image onto the moving map to allow the pilot to update the moving map in an effort to correct the error associated with the dead reckoned positions. Neither the sensor display's image nor the moving map can be equated to the generation of "a three-dimensional projected image" generated based upon "a digital database" stored in the control center. The sensor display's image is based on image data transmitted from the RPV, while the moving map contemplated by Lyons is a two-dimensional, top down view displayed using film (see Figures 5 and 7).

Having described the map matching techniques from Lyons, Applicant will now describe the terrain map correlation technique of Lyons. The terrain map correlation technique described in Lyons is also used for correcting the error in dead reckoned positions shown to the pilot by a two-dimensional moving map. In particular, Lyons states at page 5-3, last paragraph:

The office action states that Lyons teaches a remotely piloted aircraft that transmits its position and orientation. However, Lyons actually teaches the remotely piloted aircraft transmitting either: 1) video or radar image data; or 2) laser measurements (see above and footnote). Neither the video/radar image or the laser measurements are the RPV's position, but are data used to either manually or automatically update the dead reckoned position of the Lyons system. Thus, Lyons does not teach the claimed transmission of the remotely piloted aircraft's position and orientation in three dimensional space (see claims 24 and 32).

In addition, the office action cites pages 5-4, third paragraph, and Figure 8 as disclosing a single system that accesses a database based on the remotely piloted aircraft's transmitted position and orientation and transforms the terrain data into a projected image. However, Figure 8 is for a first system in which the RPV uses a "forward looking sensor" to transmit a video image and the pilot station uses anamorphic projection to overlay that image on a 2D moving map, which is not generated by transforming a database of polygons (see page 5-3, paragraph 6), while pages 5-4, third

Reconnaissance or forward-looking sensors provide a convenient method of updating the navigation system. However, these sensors required large datalink bandwidth to transmit the video picture to the control center and hence are vulnerable to ECM... Hence, an alternative method of updating the navigation system is desirable. (emphasis added)

The phrase "updating the navigation system" is used throughout Lyons to refer to the adjustment of a two-dimensional moving map in an effort to correct for error due to dead reckoning.

Rather than requiring the user to actively update the moving map display (i.e., push a button which causes the images to be superimposed, adjusting the moving map, and pushing an accept button), the terrain map correlation technique attempts to adjust the moving map (i.e., correct for the dead reckoned error) without pilot intervention using a laser range measurements and a digital elevation database. In operation, the RPV transmits to the control center a set of laser range measurements (including an altimeter reading). The control center uses dead reckoned positions to both adjust the two-dimensional moving map and to estimate the location of the RPV over a digital database map of elevation points stored in the control center (Figure 10). Based on a calculation of the possible error associated with the dead reckoned positions, a search area is identified in the digital database (Figure 12). A search is then performed within this search area to identify the position that most closely matches the transmitted laser range data. The RPV's position is then updated to the location that best matches the transmitted laser ranges in an attempt to correct the error associated with the dead reckoned positions. The moving map is then automatically adjusted (without pilot intervention) to reflect the updated RPV position.

Thus, the digital database of Lyons (conceptually illustrated in Figure 10) is not used to generate a three-dimensional projected image, but is used to update the two-dimensional moving map in an effort to correct for the error in the dead reckoned positions. In addition to the description in Lyons, further support for the fact that the digital database of Lyons is not used to generate a three-dimensional projected image is that the image of Figure 10 is generated using square polygons. Square polygons are not guaranteed to be planar, and therefore, typically are not used for generating images. In contrast, triangular polygons are guaranteed to be planar and are typically used for displaying images.

paragraph describe a second system in which the RPV transmits laser measurements in lieu of a video stream - Lyons describes the advantages of using one over the other.

With reference to the laser system, the database is simply used to correct for the accumulating error in the dead reckoned position. Once the actual location of the RPV is corrected using the database and laser measurements, the database is no longer used or transformed. In contrast, the image generated by Lyon's pilot station is the 2D moving map with an indication of the corrected RPV location (see footnote 1 for support). Thus, Lyons does not teach the claimed transformation of the terrain data in the database to generate a projected image based on the position and orientation transmitted by the RPV.

2. The Combination of Lyons and Wysoki or Fant or Beckwith

The office action cites Wysoki or Fant or Beckwith as teaching the generation of three dimensional image data from a digital database. However, the claimed invention requires that the database represent the terrain using polygons (see Applicant's claim 24, lines 9 - 10 and claim 32, lines 10-11). None of Lyons, Wysoki, Fant or Beckwith generate a projected image using polygons². Furthermore, none of Wysoki, Fant or Beckwith teach the limitations of the claims discussed above with reference to Lyons. Therefore, the combination does not teach the transmission by the RPV of its position and orientation in three dimensional space, and the pilot station using the received position and orientation to transform a database representing real terrestrial terrain using polygons into a three dimensional projected image of the remotely piloted aircraft's environment.

¹ As described above, the data in the database of Lyons is not used to generate an image, but simply to update the dead reckoned position.

With respect to Beckwith, the digital elevation data in the database is points with a constant north up position, not polygons (see col. 6, lines 52-61; col. 7, lines 30-36).

Fant describes the use of two databases: 1) the object library database which contains real-world images; and 2) the gaming area database which provides the information necessary for the placement of the contents of the object library, surfaces, and special effect on a grid or gaming area (see col. 6, line 38 - col. 7, line 10). In particular, the Fant patent is for a high performance computer graphics system that combines Computer Generated Imagery (CGI) with Computer Synthesized Imagers (CSI) to form Computer Generated Synthesized Imagery (CGSI) (see col. 2, line 53 - col. 3, line 12).

Wysoki describes a database of digital orthophotographs (see col. 4, lines 43-51). Digital orthophotographs are computerized images generated by making geometric corrections to scanned aerial photographs. In particular, an aerial photograph contains some degree of distortion. In contrast, maps maintain a constant scale, but lack the detail of an aerial photograph. Orthophotography combines the features of maps and aerial photographs. The aerial photographs are unwrapped (to remove the distortion) and fitted to a particular map projection to create an image map that has uniform scale and known accuracy.

01614

As a result, in certain embodiments of the invention, the remote pilot can fly the RPV without any image data being transmitted by the RPV, but based on the 3D projected image generated by transforming the database, with respect to the RPV position and orientation received by the pilot station from the RPV, into a 3D image. In other words, the pilot in the claimed system need not rely on image data transmitted from the RPV to fly the RPV. For at least this reason, it is respectfully submitted that these claims are allowable over the cited prior art.

35 U.S.C. §103 rejection, over Lyons in view of Wysoki or Fant or Beckwith, and further in view of Kanaly

The Examiner has rejected Claims 10, 11, 19, 20, and 33 under 35 U.S.C. §103 as being obvious over Lyons in view of Wysoki or Fant or Beckwith, and further in view of Kanaly.

As stated above, claim 1 has been amended to include the limitations of claims 2, 10 and 11. Similarly Claim 14 has been amended to include the limitations of claims 19 and 20. Thus, Claims 1 and 14 are discussed under this rejection.

Similar to the limitations of Claims 24 and 32, Claims 1 and 14 require that the RPV transmit its position and orientation in three dimensional space to the pilot station and that the pilot station transform the terrain data with respect to the position and orientation to generate a three dimensional projected image. As previously stated, the combination of reference does not teach these limitations.

In addition, Claims 1, 14 (as amended) and claim 33 include the limitations of determining the delay time for communication between the pilot station and RPV, as well as adjusting the sensitivity of the flight controls based on the determined delay time.

Kanally does not teach or suggest these limitations. In contrast, Kanaly deals with a system in which a remote operator wears a helmet (on which an oculometer is mounted) that determines where the remote operator is looking. Signals indicating where

01615

the remote operator is looking are sent to the RPV. The RPV includes a camera. The prior art system over which Kanaly distinguishes is one in which the camera on the RPV provides high resolution data in the center and low resolution data on the periphery. As a result, the prior art system must move the camera in response to the remote operators movements. This camera movement introduces a delay in the image provided to the remote operator.

To reduce or remove this delay (not measure it or adjust flight controls) due to movement of the camera, Kanaly teaches having the camera store high resolution data over the whole scene in a memory on board the RPV. The RPV transmits the high resolution imagery corresponding to the center of where the remote operator is looking and low resolution imagery (based on the stored high resolution data) corresponding to the remote operator's peripheral vision. As a result, movement of the remote operator's head merely requires the RPV adjust from where in the memory the high and low resolution data is accessed - the camera need not be moved. "Because the high resolution data is obtained from memory and not from the camera equipment directly, as in the prior art, the scheme in accordance with the present invention permits the camera to be effectively decoupled from the data link." (see col. 2, line 56 - col. 3, line 24; col. 8, line 54 - col. 9, line 6).

Thus, Kanaly does not teach the measurement of a communication delay in order to adjust the sensitivity of flight controls based on that delay (see claims 1, 14, and 33). For at least this reason, it is respectfully submitted that these claims are allowable.

35 U.S.C. §103 rejection, over Lyons in view of Wysoki or Fant or Beckwith, and further in view of Thornberg

The Examiner has rejected Claims 12-13 and 21-22 under 35 U.S.C. §103 as being obvious over Lyons in view of Wysoki or Fant or Beckwith, and further in view of Thornberg.

Claims 12-13 and 21-22 are each dependent on one of the allowable base claims 1 and 14. For at least this reason, Applicant respectfully submits that claims 12-13 and 21-22 are allowable.

New claims 50 -53

Claims 50 - 52 each require that the remotely piloted aircraft include some device for capturing image data but that the system operate in at least a first mode in which that image data is not transmitted and/or not used to pilot the aircraft. In other words, the pilot in the claimed system cannot rely on image data transmitted from the RPV (as in certain systems of Lyons - radar and video data) to fly the RPV. In certain embodiments of the invention, the remote pilot can fly the RPV based on the 3D projected image generated by transforming the database with respect to the RPV position and orientation received by the pilot station from the RPV. Of course, additional information that is not image data could also be transmitted.

Claim 53 specifies the manner in which the flight controls used to pilot the aircraft are operated. In particular, certain joystick controls on aircraft operate to indicate a rate of rotation (e.g., pushing a joystick to the right means the aircraft should start turning right at the speed indicated by the orientation of the joystick - if the position is held, the plane will roll). However, the claimed manner of operation requires the joystick position indicate the orientation of the aircraft with respect to the horizon (e.g., joystick centered causes the aircraft to fly straight; joystick pushed to the right causes the aircraft to bank to the right at the angle indicated by the joystick - not roll; etc.).

Conclusion

Applicant respectfully submits that the rejections have been overcome by the amendments and remarks, and that the Claims are now in condition for allowance.

Accordingly, Applicant respectfully requests the rejections be withdrawn and the Claims as amended be allowed.

Drawing Corrections

The drawings have been objected to by the draftsman. The Applicant will file amended drawings at the time of allowance of the present application.

Invitation for a telephone interview

The Examiner is invited to call the undersigned at 408-720-8598 if there remains any issue with allowance of this case.

Charge our Deposit Account

Please charge any shortage to our Deposit Account No. 02-2666.

Respectfully submitted,

BLAKELY, SOKOLOFF, TAYLOR & ZAFMAN LLP

Date: 2/27, 1998

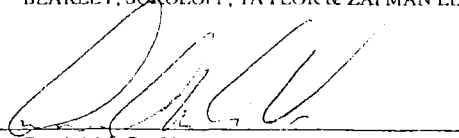
Daniel M. De Vos
Reg. No. 37,813

12400 Wilshire Boulevard
Seventh Floor
Los Angeles, California 90025-1026
(408) 720-8598



GP 3614

Attorney's Docket No.: 002055.P004 Patent
 In re the Application of: Jed Margolin (inventor(s))
 Application No.: 08/587,731
 Filed: January 19, 1996
 For: A Method and Apparatus for Remotely Piloting an Aircraft
 (title)

RECEIVED
 95 MAR 20 PM 5:42
 0101 0200

ASSISTANT COMMISSIONER FOR PATENTS
 Washington, D.C. 20231

SIR: Transmitted herewith is an Amendment for the above application.

Small entity status of this application under 37 C.F.R. §§ 1.9 and 1.27 has been established by a verified statement previously submitted.
 A verified statement to establish small entity status under 37 C.F.R. §§ 1.9 and 1.27 is enclosed.
 No additional fee is required.

The fee has been calculated as shown below:

(Col. 1)		(Col. 2)		(Col. 3)	SMALL ENTITY		OTHER THAN A SMALL ENTITY	
	Claims Remaining After Amd.	Minus	Highest No. Previously Paid For	Present Extra	Rate	Additional Fee	Rate	Additional Fee
Total Claims	* 38	Minus	** 49	0	x11	\$ 0	x22	\$
Indep. Claims	* 3	Minus	*** 5	0	x41	\$ 0	x82	\$
<input type="checkbox"/> First Presentation of Multiple Dependent Claim(s)					+135	\$ 0	+270	\$
* If the entry in Col. 1 is less than the entry in Col. 2, write "0" in Col. 3. ** If the "Highest No. Previously Paid For" IN THIS SPACE is less than 20, write "20" in this space. *** If the "Highest No. Previously Paid For" IN THIS SPACE is less than 3, write "3" in this space. The "Highest No. Previously Paid For" (Total or Independent) is the highest number found from the equivalent box in Col. 1 of a prior amendment or the number of claims originally filed.					Total Add. Fee	\$ 0	Total Add. Fee	\$ 0

I hereby certify that this correspondence is being deposited with the United States Postal Service as first class mail with sufficient postage in an envelope addressed to the Assistant Commissioner for Patents, Washington, D.C. 20231

on February 27, 1998
 Date of Deposit

Conny Van Dalen
 Name of Person Mailing Correspondence

Conny Van Dalen 2-27-98
 Signature Date

01619

_____ A check in the amount of \$ _____ is attached for presentation of additional claim(s).
_____ Applicant(s) hereby Petition(s) for an Extension of Time of _____ month(s) pursuant to
37 C.F.R. § 1.136(a).

_____ A check for \$ _____ is attached for processing fees under 37 C.F.R. § 1.17.
_____ Please charge my Deposit Account No. 02-2666 the amount of \$ _____.

A duplicate copy of this sheet is enclosed.

The Commissioner of Patents and Trademarks is hereby authorized to charge payment of the
following fees associated with this communication or credit any overpayment to Deposit Account
No. 02-2666 (a duplicate copy of this sheet is enclosed):

Any additional filing fees required under 37 C.F.R. § 1.16 for presentation of
extra claims.

Any extension or petition fees under 37 C.F.R. § 1.17.

BLAKELY SOKOLOFF TAYLOR & ZAFMAN LLP

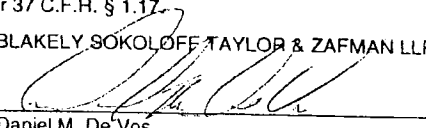

Daniel M. De Vos

Reg. No. 37,813

Date: 2/27, 1998

12400 Wilshire Boulevard
Seventh Floor
Los Angeles, California 90025
(408) 720-8598

01620

08/587,731



**UNITED STATES DEPARTMENT OF COMMERCE
Patent and Trademark Office**

Address: COMMISSIONER OF PATENTS AND TRADEMARKS
Washington, DC 20231

APPLICATION NO.	FILING DATE	FIRST NAMED INVENTOR	ATTORNEY DOCKET NO.
08/587,731	01/19/96	MARGOLIN	J 002055.P004

PM21/0504
 BLAKELY SOKOLOFF TAYLOR AND ZAFMAN
 12400 WILSHIRE BOULEVARD
 7TH FLOOR
 LOS ANGELES CA 90025

EXAMINER

NGUYEN, T

ART UNIT	PAPER NUMBER
3614	11

DATE MAILED: 05/04/98

Please find below and/or attached an Office communication concerning this application or proceeding.

Commissioner of Patents and Trademarks

Tan Nguyen
 TAN Q. NGUYEN
 PATENT EXAMINER

01621

Office Action Summary

Application No. 08/587,731	Applicant(s) MARGOLIN
Examiner TAN Q. NGUYEN	Group Art Unit 3614

Responsive to communication(s) filed on 3/2/98

This action is **FINAL**.

Since this application is in condition for allowance except for formal matters, prosecution as to the merits is closed in accordance with the practice under *Ex parte Quayle*, 1935 C.D. 11; 453 O.G. 213.

A shortened statutory period for response to this action is set to expire THREE month(s), or thirty days, whichever is longer, from the mailing date of this communication. Failure to respond within the period for response will cause the application to become abandoned. (35 U.S.C. § 133). Extensions of time may be obtained under the provisions of 37 CFR 1.136(a).

Disposition of Claims

- Claim(s) 1-9, 12-18, 21-38, and 50-53 is/are pending in the application.
- Of the above, claim(s) _____ is/are withdrawn from consideration.
- Claim(s) _____ is/are allowed.
- Claim(s) 1-9, 12-18, 21-38, and 50-53 is/are rejected.
- Claim(s) _____ is/are objected to.
- Claims _____ are subject to restriction or election requirement.

Application Papers

- See the attached Notice of Draftsperson's Patent Drawing Review, PTO-948.
- The drawing(s) filed on _____ is/are objected to by the Examiner.
- The proposed drawing correction, filed on _____ is approved disapproved.
- The specification is objected to by the Examiner.
- The oath or declaration is objected to by the Examiner.

Priority under 35 U.S.C. § 119

- Acknowledgement is made of a claim for foreign priority under 35 U.S.C. § 119(a)-(d).
- All Some* None of the CERTIFIED copies of the priority documents have been
- received.
- received in Application No. (Series Code/Serial Number) _____.
- received in this national stage application from the International Bureau (PCT Rule 17.2(a)).
- *Certified copies not received: _____
- Acknowledgement is made of a claim for domestic priority under 35 U.S.C. § 119(e).

Attachment(s)

- Notice of References Cited, PTO-892
- Information Disclosure Statement(s), PTO-1449, Paper No(s). 9
- Interview Summary, PTO-413
- Notice of Draftsperson's Patent Drawing Review, PTO-948
- Notice of Informal Patent Application, PTO-152

--- SEE OFFICE ACTION ON THE FOLLOWING PAGES ---

01622

Serial No.: 08/587,731
Art Unit: 3614

2

DETAILED ACTION

Notice to Applicant(s)

1. This office action is responsive to the amendment filed on March 02, 1998. As per request, claims 10, 11, 19 and 20 have been canceled. Thus, claims 1, 2, 14, and 24 are amended. Claims 50-53 have been added. Thus claims 1-9, 12-18, 21-38 and 50-53 are pending.
2. The prior art submitted on March 02 has been considered.

Drawings

3. The drawings are objected to under 37 CFR § 1.84 for the reasons set forth by the draftsman. See attached PTO-948 form for details. Correction is required. However, correction of the noted defect can be deferred until the application is allowed by the examiner.

Claim Rejections - 35 USC § 103

4. The following is a quotation of 35 U.S.C. 103(a) which forms the basis for all obviousness rejections set forth in this Office action:

01623

Serial No.: 08/587,731
Art Unit: 3614

3

(a) A patent may not be obtained though the invention is not identically disclosed or described as set forth in section 102 of this title, if the differences between the subject matter sought to be patented and the prior art are such that the subject matter as a whole would have been obvious at the time the invention was made to a person having ordinary skill in the art to which said subject matter pertains. Patentability shall not be negated by the manner in which the invention was made.

5. Claims 1-9, 14-18, 23-38, and 50-53 are rejected under 35 U.S.C. § 103(a) as being unpatentable over Lyons et al. (an article entitled "Some Navigation Concepts For Remotely Piloted Vehicles", AGUARD Conference Proceedings No. 176 on Medium Accuracy Low Cost Navigation, September 1975, pages 5-1 to 5-15) in view of Wysocki et al. (5,381,338) or Fant (4,835,532) or Beckwith et al. (4,660,157), and further in view of Kanaly (4,405,843).

a. With respect to claims 1 and 14, Lyons et al. disclose the invention as claimed (see at least the abstract) including a remotely piloted aircraft (see figure 8, RPV), a communications system for communicating flight data between a computer and said remotely piloted aircraft, said flight data including said remotely piloted aircraft's position and orientation, said flight data also including flight control information for controlling said remotely piloted aircraft (see page 5-2, section Radio Navigation Using

01624

Serial No.: 08/587,731
Art Unit: 3614

4

a Data Link, and figure 6 and the related text), a digital database comprising terrain data (see pages 5-3 and 5-4, section Terrain Map Correlation; and figure 8). Lyons et al. further disclose that the computer accesses said terrain data according to said remotely piloted aircraft's position and to transform said terrain data to provide a projected image data according to said remotely piloted aircraft's orientation; a display for displaying said projected image data (see page 5-4, third paragraph, and figure 8), and a remote flight control coupled to said computer for inputting said flight control information (see figure 6).

Lyon et al. do not explicitly disclose that the computer produce a three dimensional image data from the digital database and the navigation information. However such feature is well known at the time the invention was made (for examples, see columns 6, 8; figure 1 and the related text in Wysocki et al.; see figures 1, 3 and the related text in Fant; or see figures 1, 4 and the related text in Beckwith et al.). It would have been obvious to one of ordinary skill in the art at the time the invention was made to incorporate the teaching of either Wysocki et al., Fant, or Beckwith et al. into the system of Lyon et al. in order to improve the system with the enhanced capability of displaying three-dimensional image of the remoted aircraft over the terrain data.

Lyons et al. disclose the claimed invention as discussed above except for the determination of a delay time for communicating said flight data between said

01625

Serial No.: 08/587,731
Art Unit: 3614

5

computer and said remotely piloted aircraft, and adjusting the sensitivity of said set of one or more remote flight controls based on said delay time. However, Kanaly does suggest delay time for communicating between the ground station and the remote airborne into account of controlling the remote airborne (see at least column 3, lines 15-24, and column 8, line 54 to column 9, line 6). It would have been obvious to incorporate the teaching of Kanaly into the system of Lyons et al. in order to improve the system with the enhanced capability of providing more accurate the remote flight controls to the remoted vehicle and receiving the accurate position and heading data of the vehicle from the remoted vehicle.

Thus, because of the motivation set forth above, it would have been obvious to a person of ordinary skill in the art at the time the invention was made to combine the teachings of Lyon, Kanaly, with either Wysocki et al., Fant, or Beckwith et al.

b. With respect to claims 2, 50, and 51, Kanaly discloses that the remotely piloted aircraft includes a device for capture image data (see figure 3, item 74) and the image data is stored in the memory (see figure 3, item 21 and the related text).

c. With respect to claim 3, Lyons et al. disclose that the flight data communicated between said remotely piloted aircraft and said computer is secured (see page 5-2, first paragraph of the Radio Navigation Using Data Link section).

d. With respect to claims 4, 5, 7, and 15, Lyons et al. disclose that said

01626

Serial No.: 08/587,731
Art Unit: 3614

6

remotely piloted aircraft further comprises a infra red sensor image (video camera) and means for communicating and displaying video data representing images captured by the sensor image (see page 5-3, section Map Matching, and figure 8).

e. With respect to claims 6 and 16, Lyons et al. disclose that the video data is transmitted on a different communication link (wideband transmission of video signals) than said flight data (see page 5-2, first paragraph of section Radio Navigation Using a Data Link).

f. With respect to claims 8 and 17, Lyons et al. disclose that the display is a head mounted display (see figures 5 and 6).

g. With respect to claims 9 and 18, Lyons et al. also disclose that the remote flight control is responsive to manual manipulations (see figure 6).

h. With respect to claim 23, Lyons et al. disclose that the communications unit includes at least one of a communications transceiver and a simulation port (see page 5-4 and figure 6).

i. With respect to claim 24, Lyons et al. further disclose that the database representing terrain using polygons (see figure 10).

j. With respect to claims 25-28 and 30-31, the limitations of these claims have been noted in the rejection above. They are therefore considered rejected as set forth above.

01627

Serial No.: 08/587,731
Art Unit: 3614

8

Thornberg et al. suggest a variable referenced control system for remotely operated vehicles which includes means for inputting absolute pitch and roll angles for remotely control the unmanned aerial vehicle (see at least figures 5 and 6). It would have been obvious to one of ordinary skill in the art at the time the invention was made to incorporate the teaching of Thornberg et al. into the system of Lyons et al. in order to input the pitch and roll control signals as the flight control signals for remotely control the vehicle.

7. All claims are rejected.

Remarks

8. Applicant's arguments filed on October 27, 1997 have been fully considered but they are not deemed to be persuasive. Upon amended claims, the newly added claims, and the updated search, the new ground of rejections has been set forth as above.

9. In the amendment, applicants essentially argue that the Lyon reference "fails to teach more than just the generation of the 3D image". However, upon examination of the claims, the references cited clearly cover the subject matter AS CLAIMED by the applicants. Therefore, the rejection under 35 U.S.C. § 103 is considered to be proper.

01629

Serial No.: 08/587,731
Art Unit: 3614

9

10. Applicants also argue that none of Lyons, Wysocki, Fant or Beckwith generate a projected image using polygons. Applicant's attention is directed to figure 10 of the Lyon reference in which it discloses that the terrain model includes a plurality of polygons and in figure 1, 3, 5, and column 5, lines 42-49 of the Fant reference do suggest such feature.

11. Applicants further argue that the references cited do not disclose the determining of the delay time for communication. Applicant's attention is directed to column 8, line 54 to column 9 line 35 in which it disclose such feature. Therefore, the new rejection made is considered to be proper.

12. Applicant's amendment necessitated the new ground(s) of rejection presented in this Office action. Accordingly, **THIS ACTION IS MADE FINAL**. See MPEP § 706.07(a). Applicant is reminded of the extension of time policy as set forth in 37 CFR 1.136(a).

A shortened statutory period for reply to this final action is set to expire **THREE MONTHS** from the mailing date of this action. In the event a first reply is filed within **TWO MONTHS** of the mailing date of this final action and the advisory action is not mailed until after the end of the **THREE-MONTH** shortened statutory period, then the shortened statutory period will expire on the date the advisory action is mailed, and any extension fee pursuant to 37 CFR 1.136(a) will be calculated from the mailing date of

01630

Serial No.: 08/587,731
Art Unit: 3614

10

the advisory action. In no event, however, will the statutory period for reply expire later than SIX MONTHS from the date of this final action.

13. Any inquiry concerning this communication or earlier communications from the examiner should be directed to examiner Tan Nguyen, whose telephone number is (703) 305-9755. The examiner can normally be reached on Monday-Thursday from 7:30 AM-5:00 PM. The examiner can also be reached on alternate Fridays.

If attempts to reach the examiner by telephone are unsuccessful, the examiner's supervisor, William Cucilinski, can be reached on (703) 308-3873.

Any response to this action should be mailed to:

Box AF

Commissioner of Patents and Trademarks
Washington, D.C. 20231

or faxed to:

(703) 305-7687, (for formal communications, please mark "EXPEDITED PROCEDURE"; for informal or draft communications, please label "PROPOSED" or "DRAFT")

Hand-delivered responses should be brought to Crystal Park II, 2121 Crystal Drive, Arlington, VA., Sixth Floor (Receptionist).

/tqn
May 01, 1998

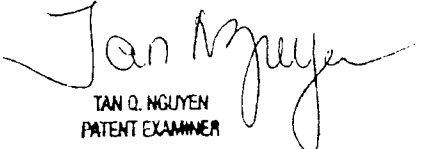
TAN Q. NGUYEN
PATENT EXAMINER

Art Unit 3614

01631

002055.P004

Patent



IN THE UNITED STATES PATENT AND TRADEMARK OFFICE

#12/Reg bar
Recon

Late Application of:
 Jed Margolin
 Serial No. 08/587,731
 Filed: January 19, 1996
 For: A Method and Apparatus for
 Remotely Piloting an Aircraft

Examiner: T. Nguyen

Art Unit: 3614

98 JUL 13 AM 9:31
 RECEIVED
 TECHNOLOGY CENTER 3000

RESPONSE UNDER 37 C.F.R. § 1.116
 -- EXPEDITED PROCEDURE --
 EXAMINING GROUP 3614

Assistant Commissioner for Patents
 Washington, D.C. 20231

RESPONSE UNDER 37 C.F.R. § 1.116
EXPEDITED PROCEDURE -- EXAMINING GROUP 3614

Sir:

Responsive to the Office Action mailed on May 4, 1998, the Applicant respectfully requests reconsideration of this application in view of the following remark:

35 U.S.C. §103 rejection, over Lyons in view of Wysoki or Fant or Beckwith, and further in view of Kanaly

The Examiner has rejected Claims 1-9, 14-18, 23-38, and 50-53 under 35 U.S.C. §103 as being obvious over Lyons in view of Wysoki or Fant or Beckwith, and further in view of Kanaly.

FIRST CLASS CERTIFICATE OF MAILING

I hereby certify that this correspondence is being deposited with the United States Postal Service as first class mail with sufficient postage in an envelope addressed to the Assistant Commissioner for Patents, Washington, D.C. 20231 on July 6, 1998

(Date of Deposit)

Conny Van Dalen

Name of Person Mailing Correspondence

Conny Van Dalen

Signature

7-6-98

Date

01632

As described in more detail below, the Office Action: 1) either clearly misdescribes Kanaly or clearly asserts an improper rejection regarding Kanaly; and 2) clearly misdescribes Lyons in stating that Lyons describes an RPV that communicates "flight data ... including said remotely piloted aircraft's position" (see Office Action page 3). In addition, Applicant submits that Lyons in view of Wysoki or Fant or Beckwith, and further in view of Kanaly does not teach the claimed invention

In order to address the numerous references used to support this rejection, Applicant discusses Kanaly; then Lyons; then the combination of Lyons and Kanaly and Wysoki or Fant or Beckwith; and finally why Applicant's claimed invention is not obvious over the asserted combination.

1) The Office Action either Misdescribes Kanaly or Asserts an Improper Rejection Regarding Kanaly

The Office Action states that Lyons does not disclose "the determination of a delay time for communicating said flight data between said remotely piloted aircraft, and adjusting the sensitivity of said set of one or more one or more flight controls based on said delay time." (see Office Action page 5) Then, the Office Action states that Kanaly "does suggest delay time for communicating between the ground station and the remote airborne into account of controlling the remote airborne." *Id.* Either, the Office Action is: 1) incorrectly asserting that Kanaly teaches that the computer monitors the time delay and adjusts the sensitivity of the controls; or 2) asserting an improper rejection because "the prior art reference (or references when combined)" do not "teach or suggest all the claim limitations," but rather teach away.

a) Assuming the Office Action is Asserting that Kanaly Describes Monitoring the Time Delay for Communication and Adjusting the Sensitivity of the Controls Based on the Measured Time Delay

01633

Kanally basically teaches the inclusion of a buffer in a remotely piloted vehicle to store high resolution image data to mask the time delay for slewing a camera.¹ However, Kanally does not describe that the pilot station computer determine the time delay for communication and adjust the sensitivity of the controls accordingly. In particular, the Office Action cites the following two sections of Kanally to support the rejection:

It also substantially increases the speed of operation of the system. Namely, a considerably shorter period of time is required to simply fetch data from memory, as compared to having to slew the camera, as in the prior art system described above. The savings in time in fetching the data from the memory permits the use of more time for digitizing, formatting, processing, etc. without delaying the image so much as to be noticeable by the console operator. (col. 3, lines 15 - 24). (emphasis added)

The above quote deals with the delay resulting from having to slew the camera, not from the communications delay.

At the ground station the incoming signals are down converted and demodulated from transceiver 54 and modem 51 equipment to obtain display control signals. The display control signals are used to control the scanning of the image pixels of the display 31, so as to generate high resolution data only at the portion corresponding to point of observation of the operator 10 and equated with that particular portion of the overall scene data stored in memory 21 aboard the remotely piloted vehicle. It has been found that the time delay from a step change in look angle by the

¹ Kanally deals with a system in which a remote operator wears a helmet (on which an oculometer is mounted) that determines where the remote operator is looking. Signals indicating where the remote operator is looking are sent to the RPV. The RPV includes a camera. The prior art system over which Kanally distinguishes is one in which the camera on the RPV provides high resolution data in the center and low resolution data on the periphery. As a result, the prior art system must move the camera in response to the remote operator's movements. This camera movement introduces a delay in the image provided to the remote operator.

To reduce or remove this delay (not measure it or adjust flight controls) due to movement of the camera, Kanally teaches having the camera store high resolution data over the whole scene in a memory on board the RPV. The RPV transmits the high resolution imagery corresponding to the center of where the remote operator is looking and low resolution imagery (based on the stored high resolution data) corresponding to the remote operator's peripheral vision. As a result, movement of the remote operator's head merely requires the RPV adjust from where in the memory the high and low resolution data is accessed - the camera need not be moved. "Because the high resolution data is obtained from memory and not from the camera equipment directly, as in the prior art, the scheme in accordance with the present invention permits the camera to be effectively decoupled from the data link." (see col. 2, line 56 - col. 3, line 24; col. 8, line 54 - col. 9, line 6).

operator 10 to a look angle correction by the oculometer 33 and changes to a new location in memory 21 from which new high resolution data is to be read out and its subsequent transmission and appearance on the display device 31 as high resolution imagery data may be less than 0.2 seconds using present day modulation and transmission rates. This minimum time delay is substantially less than the approximate 0.5 seconds required normally by the human eye before the operator becomes aware of the high resolution data that he is viewing. (col. 8, line 54 to col. 9, line 6).

The above quote merely indicates that it takes 0.2 seconds to perform the following: "a look angle correction by the oculometer 33," "changes to a new location in memory 21 from which new high resolution data is to be read out," "its subsequent transmission," and "its appearance on the display." Thus, Kanaly is discussing the delay of the overall system and how it has been improved, not the specific time delay required for communication from the RPV to the pilot station. In addition, Kanaly just recognizes that there is delay and that the delay is not perceptible to the human eye (In fact, Kanaly states that the required "0.2 seconds" is "substantially less" "than the approximate 0.5 seconds required normally by the human eye"). Since Kanally's delay is not perceptible to the human eye, it is not at all surprising that no where in Kanaly is the idea of having the computer in the pilot station measure the delay and adjust the sensitivity of the controls. As such, Kanaly teaches away from the claimed invention by teaching that the delay is not perceptible to the human eye.

b) Assuming the Office Action is Improperly basing the Rejection on the Mere Fact that Kanaly indicates that there Exist Delay in His System, and that Part of that Delay is Due to Transmission of Data

The second quote from Kanaly reproduced above clearly indicates that Kanaly has determined that the delay associated with "a look angle correction by the oculometer 33," "changes to a new location in memory 21 from which new high resolution data is to be read out," "its subsequent transmission," and "its appearance on the display" is less than 0.2 seconds. This provides no support for the rejection.

01635

According to M.P.E.P. § 2142:

[t]o establish a primary facie case of obviousness, ... the prior art reference (or references when combined) must teach or suggest all the claim limitations. The teaching or suggestion to make the claim combination and the reasonable expectation of success must both be found in the prior art, and not based on applicant's disclosure." (emphasis added).

The determination by Kanaly that the delay time for his overall system is imperceptible by the human eye does not even come close to teaching or suggesting the claimed limitation of having the computer in the pilot station measure the time delay, much less doing anything about that time delay (e.g., adjusting the sensitivity of the controls). In fact, Kanaly indicates that the delay is imperceptible (0.2 is "substantially less" than 0.5 seconds), and thereby indicates no need to do anything about the delay. Thus, if the Office Action is asserting that the mere fact that Kanaly has determined a static time of 0.2 seconds for his system and that this time is imperceptible to the human eye as teaching or suggesting the claimed limitations, the rejection is improper because claim limitations that are not taught or suggested by Kanaly are being ignored. In fact, Kanaly teaches away from the claimed invention by teaching that the delay is not perceptible to the human eye.

2) The Office Action Misdescribes Lyons

Although Lyons has been extensively described in Applicant's prior responses and discussed at length in an interview, the Office Action continues to assert that Lyons describes the transmission of flight data from the aircraft, where that flight data includes the aircraft's position. This is clearly not the case.

Lyons teaches the use of dead reckoning.² Dead reckoning is the determination of an estimated or dead reckoned position that is based on various elements (including

² In summary, the Lyons reference teaches various techniques for updating the dead reckoned position of remotely piloted aircraft on a two dimensional moving map display available to the pilot. In particular, Lyons contemplates a RPV transmitting information to a control center (Figure 1). The control center is used by the pilot to fly the RPV. To display the position of the RPV to the pilot, the control center provides a "moving map display." As contemplated by Lyons, "the most convenient display mode for the present application is the rolling map or "passing

scene' technique where a new line is added to the top of the display and the scene is shifted slowly downwards" (page 5-3, end of first full paragraph). In particular, Lyons contemplates using film to generate the moving map (Figure 5). The moving map is moved based on the dead reckoned positions of the RPV.

As is well known in the art, dead reckoned positions have accumulating error. To adjust for this error, Lyons describes two basic concepts: 1) map matching (Section 3); and 2) terrain map correlation (Section 4). The map matching concept requires that the RPV transmit some kind of image data to the control center. In Figure 6, the control center is shown having the moving map display and the sensor display (i.e., a display generated from the image data transmitted by the RPV). Lyons contemplates the transmission of two kinds of image data: 1) side looking radar (SLR); and 2) real time forward-looking sensors. When using the SLR system, the SLR generated image data received by the control center allows it to make a downward-looking image. The pilot watches the sensor display (i.e., the display generated based on the transmitted image data) for "likely update features"—landmarks. When the pilot sees a landmark in the sensor display, the pilot presses a transfer button which causes the control center to superimpose the sensor display over the moving map (Figure 5). The pilot then adjusts the moving map so that it matches the overlaid sensor display image and presses an accept button. By adjusting the moving map in this manner, the dead reckoned position of the RPV is updated in an attempt to remove the error associated with the calculation of dead reckoned positions (Page 5-3, second, third, and fourth full paragraphs). The simulated SLR/map update system is illustrated in Figures 7A and 7B.

Having described the SLR-based map matching technique, the real time forward-looking sensor technique will now be described. Lyons describes basically two techniques of updating dead reckoned RPV positions on a moving map using only real time forward-looking sensors: 1) an anamorphic projection technique (page 5-3, fifth full paragraph; Figure 8); and 2) a HUD based technique (page 5-3, sixth full paragraph; Figure 9). Similar to the SLR based technique, the anamorphic projection technique requires the pilot to watch the sensor display (i.e., the image generated from the transmitted data) for landmarks, press a button which superimposes the transmitted image on the moving map, adjust the moving map, and press an accept button. As described in Lyons, in order to superimpose the forward-looking transmitted image on the moving map, the forward-looking image is transformed using anamorphic projection. Lyons goes on to describe various problems with the anamorphic projection technique, and then describes the HUD based technique.

In the HUD based technique, the pilot is presented with two images: 1) the moving map display (see left-hand image of Figure 9); and 2) the sensor display generated from the image data transmitted from the real time forward-looking sensor on the RPV. The HUD technology is used to allow the pilot to mark landmarks on the forward-looking sensor based image. These HUD markings are then superimposed on the moving map, and the pilot makes the necessary adjustments to the moving map (page 5-3, sixth full paragraph).

In summary, the map matching techniques use the following: 1) the transmission of image data from the RPV to the control center; 2) a display at the control center which shows an image based on the real time image data received from the RPV; 3) a moving map display that is moved based on the dead reckoned position of the RPV; and 4) some manner of superimposing the sensor image onto the moving map to allow the pilot to update the moving map in an effort to correct the error associated with the dead reckoned positions. The sensor display's image is based on image data transmitted from the RPV, while the moving map contemplated by Lyons is a two-dimensional, top down view displayed using film (see Figures 5 and 7).

Having described the map matching techniques from Lyons, Applicant will now describe the terrain map correlation technique of Lyons. The terrain map correlation technique described in Lyons is also used for correcting the error in dead reckoned positions shown to the pilot by a two-dimensional moving map. In particular, Lyons states at page 5-3, last paragraph:

Reconnaissance or forward-looking sensors provide a convenient method of updating the navigation system. However, these sensors required large datalink bandwidth to transmit the video picture to the control center and hence are vulnerable to ECM... Hence, an alternative method of updating the navigation system is desirable. (emphasis added)

The phrase "updating the navigation system" is used throughout Lyons to refer to the adjustment of a two-dimensional moving map in an effort to correct for error due to dead reckoning.

Rather than requiring the user to actively update the moving map display (i.e., push a button which causes the images to be superimposed, adjusting the moving map, and pushing an accept button), the terrain map correlation technique attempts to adjust the moving map (i.e., correct for the dead reckoned error) without pilot intervention using a laser range measurements and a digital elevation database. In operation, the RPV transmits to the control center a set of laser range measurements (including an altimeter reading). The control center uses dead reckoned positions to both adjust the two-dimensional moving map and to estimate the location of the RPV over a digital database map of elevation points stored in the control center (Figure 10). Based on a calculation of the possible error associated with the dead reckoned positions, a search area is identified in the digital database (Figure 12). A search is then performed within this search area to identify the position that most closely matches the transmitted laser range data. The RPV's position is then updated to the location that best matches the transmitted laser ranges in an attempt to correct the error associated with the dead reckoned positions. The moving map is then automatically adjusted (without pilot intervention) to reflect the updated RPV position.

speed, direction, etc), that has accumulating error, and that must be corrected before generating any image. As such, the Lyons paper discusses techniques for correcting or updating the dead reckoned positions. In particular, Lyons states "The objective is to make use of equipment normally carried for RPV operation to supplement a simple dead reckoning navigation system." (abstract).

In particular, Lyons describes transmitting laser measurements for updating the dead reckoned position. The pilot station determines error associated with dead reckoning; identifies a search area in the digital ELEVATION database based on the dead reckoned position - where the current dead reckoned position is the center of the search area ("expected RPV position" in Figure 12) and the search area represents the locations the RPV could be due to the accumulating error in the current dead reckoned position; compares the transmitted laser measurements for various positions in the search area in an effort to locate a corrected dead reckoned position of the RPV.³

In fact, Lyons states the following:

This paper discusses methods by which the navigation function for a Remotely Piloted Vehicles (RPVs) can be achieved without the need for complex specialized navigation equipment. The objective is to make use of equipment normally carried for RPV operation to supplement a simple dead reckoning navigation system. In this way significant improvements in navigation capability can be achieved with little or no added complexity in the vehicle itself. The additional processing is carried out at the control centre where restrictions on equipment size and cost are not so prohibitive. (Abstract)

Thus, the digital database of Lyons (conceptually illustrated in Figure 10) is used to update the two-dimensional moving map in an effort to correct for the error in the dead reckoned positions.

³ In addition, the office action cites pages 5-4, third paragraph, and Figure 8 as disclosing a single system that accesses a database based on the remotely piloted aircraft's transmitted position and orientation and transforms the terrain data into a projected image. However, Figure 8 is for a first system in which the RPV uses a "forward looking sensor" to transmit a video image and the pilot station uses anamorphic projection to overlay that image on a 2D moving map, which is not generated by transforming a database of polygons (see page 5-3, paragraph 6), while pages 5-4, third paragraph describe a second system in which the RPV transmits laser measurements in lieu of a video stream - Lyons describes the advantages of using one over the other.

01633

Again, none of the data transmitted by the RPV (whether it be flight data for dead reckoning, the dead reckoned position, nor the laser measurements) is the position of the aircraft; everything transmitted by Lyon's RPV is data used by the pilot station to determine a corrected dead reckoned position of the aircraft through complicated processing, which corrected dead reckoned position is used for display.

Now that Applicant has put forth a more correct reading of Lyons, Applicant will address what results from combining Lyons with Wysoki or Fant or Beckwith.

3) The combination of Lyons and Wysoki or Fant or Beckwith, in further view of Kanaly

Lyons describes that the remote pilot station displays to the remote pilot a two-dimensional moving map (which is not based at all on the digital elevation database) on which the position of the remote aircraft is indicated. In particular, Lyons uses the digital elevation database in the remote pilot station in conjunction with the laser measurements for automatically updating the dead reckoned position indicated on the two-dimensional moving map.

The Office Action asserts that the combination of Lyons and Wysoki or Fant or Beckwith would result in a system that produces "a three dimensional image data from the digital database and the navigation information." First, the claims are not that the image is generated from the digital database and some vague notion of "navigation information," but require that the transmitted position and orientation be used to generate the three dimension image (as stated above, Lyons describes a very different system in which the transmitted data is not used for image generation, but that the transmitted data goes through complicated processing to generate a corrected dead reckoned position and that it is the corrected dead reckoned position that is used for image generation). Thus, the Office Action's language is improperly disregarding limitations in the claims.

01639

Second, the combination of Lyons Kanaly and Wysoki or Fant or Beckwith would result in a system according to the following table, where the addition of Kanaly for the purposes asserted by the Office Action would merely result in making a determination of the time delay of the entire system to illustrate that the combination is better than the prior art and/or fast enough not to be perceptible by the human eye.

Lyons in view of Wysoki or Fant or Beckwith, and further in view of Kanaly	Applicant's Invention
Aircraft transmits dead reckoning information	Aircraft determines its own position and orientation, and then transmits its own position and orientation
Aircraft transmits laser measurements for automatic dead reckoned position update	
Pilot station determines error associated with dead reckoning; identifies a search area in the digital database based on the dead reckoned position - where the current dead reckoned position is the center of the search area ("expected RPV position" in Figure 12) and the search area represents the locations the RPV could be due to the accumulating error in the current dead reckoned position; compares the transmitted laser measurements for various position in the search area in an effort to locate a corrected position of the RPV.	

01640

As modified by Wysoki, Fant or Beckwith, the pilot station would then <u>also</u> transform the <u>digital database</u> relative to the corrected dead reckoned position to generate a three dimensional image.	The pilot station transforms the digital database relative to the position and orientation transmitted from the aircraft to generate a three dimensional image.
Knowing the time delay and that it is imperceptible to the human eye	The pilot station computer measuring the time delay to communicate with the aircraft (see claims 1 & 14)
	The pilot station computer adjusting the sensitivity of the controls based on the measured time delay (see claims 1 & 14)

Thus, the asserted combination would result in forgoing Lyon's two-dimensional map, and instead using Lyons digital database to generate a three-dimensional image (through some technique in Wysoki, Fant or Beckwith) relative to a corrected dead reckoned position. The above table is a fair read of the combination of Lyons and Wysoki or Fant or Beckwith because none of Wysoki or Fant or Beckwith describe a manner of piloting of a remotely piloted aircraft; in contrast Wysoki and Fant and Beckwith describe how to generate three dimensional images from various databases (none of which store the terrain as a set of polygons).

4) The Claimed Invention is Not Obvious in view of the combination of Lyons and Wysoki or Fant or Beckwith, and further in view of Kanaly

Clearly, the above table illustrates that the combination of Lyons and Wysoki, Fant or Beckwith does not describe Applicant's claimed invention. In particular, the combination of Lyons, Kanaly, and Wysoki or Fant or Beckwith results in a system that uses transmission of dead reckoning information by the aircraft, some mechanism in the

01641

pilot station to correct the dead reckoned positions, and some scheme to generate images based on the corrected dead reckoned position.⁴

The laser measurement system of Lyons⁵ relied on by the Office Action requires the use of "terrain-referenced navigation" - that is, Lyons describes searching an elevation database in a search area (based on the estimated error in the dead reckoned position) for a match to a set of elevation based laser measurements. Terrain-referenced navigation suffers from a number of disadvantages, including an inability to function over non-unique terrain (e.g., flat terrain such as deserts, water, etc.). For example, assume that Lyons RPV is flying over water. The three or more laser measurements taken by the RPV will all indicate that the terrain over which the RPV is flying is a relatively constant elevation. According to Lyons, the three or more laser measurements would be compared to locations in an estimated error region that is a relatively constant elevation because it maps a body of water. As such, the laser measurements can no longer be used to correct the dead reckoned position. In fact, Lyons states:

Apart from the errors involved in the actual laser measurements the accuracy of terrain representation has a considerable influence on the feasibility of the method. In addition, the technique is ineffective over the sea or over flat, featureless terrain. (section 4). (emphasis added).

⁴ Lyons states the following:

This paper discusses methods by which the navigation function for a Remotely Piloted Vehicles (RPVs) can be achieved without the need for complex specialized navigation equipment. The objective is to make use of equipment normally carried for RPV operation to supplement a simple dead reckoning navigation system. In this way significant improvements in navigation capability can be achieved with little or no added complexity in the vehicle itself. The additional processing is carried out at the control centre where restrictions on equipment size and cost are not so prohibitive. ... Use can also be made of an on-board laser to provide range-to-terrain measurements which, when correlated with a computer stored map, enables the RPV position to be continuously updated. (Abstract)

⁵ Lyons describes basically two systems: 1) a higher bandwidth system that uses dead reckoning and transmits images from the RPV to the pilot station for updating the dead reckoned positions; and 2) a lower bandwidth system that also uses dead reckoning, but uses laser measurements for updating the dead reckoned positions. Unlike the former, Applicant's claimed system does not require the transmission of images to fly the aircraft and to correct dead reckoned positions, but has the remotely piloted aircraft determine and transmit its position and generates three-dimensional images from the database in the pilot station from that transmitted position. As described in the text, unlike the later, Applicant's claimed system does not use terrain-referenced navigation.

01642

Where the data link is limited in bandwidth the laser/terrain correlation technique should give good accuracy and the process could be completely automated to provide a continuous indication of RPV position. Disadvantages of the system are the large amount of data storage and computation necessary at the control centre, the development work required to produce an operational system and the unsuitability of the system over featureless terrain. (section 5). (emphasis added)

Applicant's claimed invention does not use Lyons dead reckoned positions that must be corrected in the pilot station using terrain-referenced navigation, but rather Applicant's claimed invention requires the remotely piloted aircraft determines and transmits its own position to the pilot station and that it is this transmitted position and orientation that is used to generate the three dimensional images (not an untransmitted corrected dead reckoned position). Again, the asserted combination results in a system in which the digital database in the pilot station is accessed based on the error associated with the dead reckoned position, and then the digital database is accessed using the correct dead reckoned position to generate the three dimensional image (in other words, the asserted combination does not generate the three-dimensional image using the position and orientation transmitted from the RPV; in contrast the asserted combination uses a corrected dead reckoned position that was not transmitted by the RPV). Thus, none of the data transmitted by the RPV (whether it be flight data for dead reckoning, the dead reckoned position, image data, or the laser measurements) is the position of the aircraft; rather, everything transmitted by Lyon's RPV is data used by the pilot station to determine a corrected dead reckoned position of the aircraft through complicated processing, which corrected dead reckoned position is used for display. Thus, Lyons teaches away from Applicant's claimed invention in that Lyon's "objective" is to put the onus of determining the position of the RPV on the pilot station to "supplement a simple dead reckoning navigation system," whereas Applicant's claimed invention puts the onus

01643

of determining position on the remotely piloted vehicle and uses the transmitted position to generate the three dimensional image.

In particular, Applicant's claim 32 requires "determining the current position of said remotely piloted aircraft in three dimensions; ... communicating said current position .. from said remotely piloted aircraft to a pilot station; transforming said terrain data into image data representing a simulated three dimensional view according to the current position; displaying said simulated three dimensional view using said image data." Thus, Applicant's claim 32 requires that the three-dimensional image be produced from the TRANSMITTED position, not one that is corrected or updated using some laser measurement dead reckoning scheme. Since Applicant's claimed invention requires the remotely piloted aircraft to determine and transmit its own position to the pilot station and that it is this transmitted position and orientation that is used to generate the three dimensional images, Applicant's system provides an advantage over Lyons in that Applicant's system does not have difficulty over featureless terrain.

Furthermore, Claims 1 and 14 have additional limitations that the Office Action improperly asserts are found in Kanaly. The determination by Kanaly that the delay time for his overall system is imperceptible by the human eye does not even come close to teaching or suggesting the claimed limitation of having the computer in the pilot station measure the time delay, much less doing anything about it (e.g., adjusting the sensitivity of the controls). In fact, Kanaly indicates that the delay is imperceptible (0.2 is "substantially less" than 0.5 seconds), and thereby indicates no need to do anything about the delay. Thus, Kanaly teaches away from the claimed invention by teaching that the delay is not perceptible to the human eye. In contrast, the language of claims 1 and 14 requires that the computer in the pilot station determine the delay and adjust the sensitivity of the controls. If there was a static time delay in transmission and/or the delay was imperceptible, the sensitivity of the flight controls of Applicant's system could be permanently set. However, Applicant claim language requires that the computer in the

01644

pilot station determine the time delay of the communication and adjust the sensitivity of the controls, thereby requiring at least one real time measurement of the delay and some adjustment.

Furthermore, Applicant's claims 24 and 32 require that the database store the terrain data as polygons. As previously described, none of art used in the rejection make use of a database that stores the terrain data as a set of polygons. In particular, Lyons describes the use of an Elevation Database in which each point represents an elevation. Although Figure 10 from Lyons shows (for illustrative purposes only because Lyons does not display an image from the database) lines connecting the elevation points, the points in an elevation database are not stored as polygons. While the images generated by Wysoki or Beckwith of Fant may look like one or more polygons, the terrain is not stored in their databases as polygons.⁶ In contrast, Applicant's claim 24 requires the transmitted "position and orientation" be transformed "into a three dimensional projected image of said remotely piloted aircraft's environment according to a database representing real terrestrial terrain using polygons." Similarly, Applicant's claim 32 requires "accessing a database comprising terrain data that represents real terrestrial terrain as a set of polygons." Thus, claims 24 and 32 require that the database stores the terrain as polygons.

⁶ As described above, the data in the database of Lyons is not used to generate an image, but simply to update the dead reckoned position.

With respect to Beckwith, the digital elevation data in the database is points with a constant north up position, not polygons (see col. 6, lines 52-61; col. 7, lines 30-36).

Fant describes the use of two databases: 1) the object library database which contains real-world images; and 2) the gaming area database which provides the information necessary for the placement of the contents of the object library, surfaces, and special effect on a grid or gaming area (see col. 6, line 38 - col. 7, line 10). In particular, the Fant patent is for a high performance computer graphics system that combines Computer Generated Imagery (CGI) with Computer Synthesized Imagers (CSI) to form Computer Generated Synthesized Imagery (CGSI) (see col. 2, line 53 - col. 3, line 12).

Wysoki describes a database of digital orthophotographs (see col. 4, lines 43-51). Digital orthophotographs are computerized images generated by making geometric corrections to scanned aerial photographs. In particular, an aerial photograph contains some degree of distortion. In contrast, maps maintain a constant scale, but lack the detail of an aerial photograph. Orthophotography combines the features of maps and aerial photographs. The aerial photographs are unwrapped (to remove the distortion) and fitted to a particular map projection to create an image map that has uniform scale and known accuracy.

The remaining rejected claims are each dependent on one of the allowable base claims. For at least these reasons, Applicant respectfully request this rejection be withdrawn.

35 U.S.C. §103 rejection, over Lyons in view of Wysoki or Fant or Beckwith, and further in view of Thornberg

The Examiner has rejected Claims 12-13 and 21-22 under 35 U.S.C. §103 as being obvious over Lyons in view of Wysoki or Fant or Beckwith, and further in view of Thornberg.

Claims 12-13 and 21-22 are each dependent on one of the allowable base claims 1 and 14. For at least this reason, Applicant respectfully submits that claims 12-13 and 21-22 are allowable.

Conclusion

Applicant respectfully submits that the rejections have been overcome by the amendments and remarks, and that the Claims are now in condition for allowance. Accordingly, Applicant respectfully requests the rejections be withdrawn and the Claims as amended be allowed.

Drawing Corrections

The drawings have been objected to by the draftsman. The Applicant will file amended drawings at the time of allowance of the present application.

01646

Invitation for a telephone interview

The Examiner is invited to call the undersigned at 408-720-8598 if there remains any issue with allowance of this case.

Charge our Deposit Account

Please charge any shortage to our Deposit Account No. 02-2666.

Respectfully submitted,

BLAKELY, SOKOLOFF, TAYLOR & ZAFMAN LLP

Date: 7/6, 1998

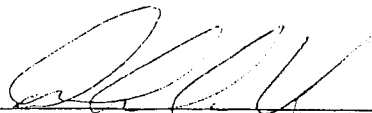

Daniel M. De Vos
Reg. No. 37,813

12400 Wilshire Boulevard
Seventh Floor
Los Angeles, California 90025-1026
(408) 720-8598

01647



Corros. and Mail
BOX AF

AF/cak 3614

Attorney's Docket No.: 002055.P004

Patent

In re the Application of: Jed Margolin
(inventor(s))

**AMENDMENT UNDER
37 C.F.R. § 1.116
EXPEDITED PROCEDURE**

Application No.: 08/587,731

EXAMINING GROUP 3614

Filed: January 19, 1996

For: A Method and Apparatus for Remotely Piloting an Aircraft

(title)

ASSISTANT COMMISSIONER FOR PATENTS
Washington, D.C. 20231
Box AF

RECEIVED
TECHNICAL CENTER
98 JUL 13 AM 9:00

SIR: Transmitted herewith is an **Amendment After Final Action** for the above application.

- Small entity status of this application under 37 C.F.R. §§ 1.9 and 1.27 has been established by a verified statement previously submitted.
- A verified statement to establish small entity status under 37 C.F.R. §§ 1.9 and 1.27 is enclosed.
- No additional fee is required.
- A Notice of Appeal is enclosed.**

The fee has been calculated as shown below:

		(Col. 1)			(Col. 2)	(Col. 3)	SMALL ENTITY		OTHER THAN A SMALL ENTITY	
		Claims Remaining After Amd.	Minus	Highest No. Previously Paid For	Present Extra	Rate	Additional Fee	Rate	Additional Fee	
Total Claims	*	38		** 49	0	x11	\$ 0	x22	\$	
Indep. Claims	*	3	Minus	*** 5	0	x41	\$ 0	x82	\$	
First Presentation of Multiple Dependent Claim(s)							+135	\$ 0	+270	\$
* If the entry in Col. 1 is less than the entry in Col. 2, write "0" in Col. 3.							Total Add. Fee	\$ 0	Total Add. Fee	\$
** If the "Highest No. Previously Paid For" IN THIS SPACE is less than 20, write "20" in this space.										
*** If the "Highest No. Previously Paid For" IN THIS SPACE is less than 3, write "3" in this space. The "Highest No. Previously Paid For" (Total or Independent) is the highest number found from the equivalent box in Col. 1 of a prior amendment or the number of claims originally filed.										

I hereby certify that this correspondence is being deposited with the United States Postal Service as first class mail with sufficient postage in an envelope addressed to the Assistant Commissioner for Patents, Washington, D.C. 20231

on July 6, 1998
Date of Deposit

Conny Van Dalen
Name of Person Mailing Correspondence

Conny Van Dalen
Signature

7-6-98
Date

01648

_____ A check in the amount of \$ _____ is attached for presentation of additional claim(s).
_____ Applicant(s) hereby Petition(s) for an Extension of Time of _____ month(s) pursuant to
37 C.F.R. § 1.136(a).

_____ A check for \$ _____ is attached for processing fees under 37 C.F.R. § 1.17.

_____ Please charge my Deposit Account No. 02-2666 the amount of \$ _____.

_____ **A duplicate copy of this sheet is enclosed.**

The Commissioner of Patents and Trademarks is hereby authorized to charge payment of the
following fees associated with this communication or credit any overpayment to Deposit Account
No. 02-2666 (a duplicate copy of this sheet is enclosed):

Any additional filing fees required under 37 C.F.R. § 1.16 for presentation of
extra claims.

Any extension or petition fees under 37 C.F.R. § 1.17.

BLAKELY SOKOLOFF TAYLOR & ZAFMAN LLP



Daniel M. De Vos

Reg. No. 37,813

Date: 7/6, 1998

12400 Wilshire Boulevard
Seventh Floor
Los Angeles, California 90025
(408) 720-8598

08/587,731



**UNITED STATES DEPARTMENT OF COMMERCE
Patent and Trademark Office**

Address: COMMISSIONER OF PATENTS AND TRADEMARKS
Washington, D.C. 20231

APPLICATION NO.	FILING DATE	FIRST NAMED INVENTOR	ATTORNEY DOCKET NO.
08/587,731	01/19/96	MARGOLIN	J 002055.P004

PM21/0724
 BLAKELY SOKOLOFF TAYLOR AND ZAFMAN
 12400 WILSHIRE BOULEVARD
 7TH FLOOR
 LOS ANGELES CA 90025

EXAMINER

NGUYEN, T

ART UNIT	PAPER NUMBER
3614	13

DATE MAILED: 07/24/98

Please find below and/or attached an Office communication concerning this application or proceeding.

Commissioner of Patents and Trademarks

Tan Q. Nguyen
 TAN Q. NGUYEN
 PATENT EXAMINER

01650

Advisory Action

Application No. 08/587,731	Applicant(s) MARGOLIN
Examiner TAN Q. NGUYEN	Group Art Unit 3614



THE PERIOD FOR RESPONSE: [check only a) or b)]

- a) expires THREE months from the mailing date of the final rejection.
- b) expires either three months from the mailing date of the final rejection, or on the mailing date of this Advisory Action, whichever is later. In no event, however, will the statutory period for the response expire later than six months from the date of the final rejection.

Any extension of time must be obtained by filing a petition under 37 CFR 1.136(a), the proposed response and the appropriate fee. The date on which the response, the petition, and the fee have been filed is the date of the response and also the date for the purposes of determining the period of extension and the corresponding amount of the fee. Any extension fee pursuant to 37 CFR 1.17 will be calculated from the date of the originally set shortened statutory period for response or as set forth in b) above.

- Appellant's Brief is due two months from the date of the Notice of Appeal filed on _____ (or within any period for response set forth above, whichever is later). See 37 CFR 1.191(d) and 37 CFR 1.192(a).

Applicant's response to the final rejection, filed on 7/9/98 has been considered with the following effect, but is NOT deemed to place the application in condition for allowance:

- The proposed amendment(s):
 - will be entered upon filing of a Notice of Appeal and an Appeal Brief.
 - will not be entered because:
 - they raise new issues that would require further consideration and/or search. (See note below).
 - they raise the issue of new matter. (See note below).
 - they are not deemed to place the application in better form for appeal by materially reducing or simplifying the issues for appeal.
 - they present additional claims without cancelling a corresponding number of finally rejected claims.

NOTE: _____

- Applicant's response has overcome the following rejection(s):

- Newly proposed or amended claims 1-9, 12-18, 21-23, and 50 would be allowable if submitted in a separate, timely filed amendment cancelling the non-allowable claims.

- The affidavit, exhibit or request for reconsideration has been considered but does NOT place the application in condition for allowance because:
Upon the response filed on July 19, 1998, the arguments are partial deemed to be persuasive. Therefore, claims 1-9, 12-18, 21-23, and 50. However, the references cited do read on claims 24-38, and 51-52.

- The affidavit or exhibit will NOT be considered because it is not directed SOLELY to issues which were newly raised by the Examiner in the final rejection.

- For purposes of Appeal, the status of the claims is as follows (see attached written explanation, if any):

Claims allowed: 1-9, 12-18, 21-23, and 50

Claims objected to: NONE

Claims rejected: 24-38, 51, and 52

- The proposed drawing correction filed on _____ has has not been approved by the Examiner.

- Note the attached Information Disclosure Statement(s), PTO-1449, Paper No(s) _____.

- Other

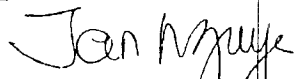
TAN Q. NGUYEN
PRIMARY EXAMINER
ART UNIT 3614

002055.P004

IN THE UNITED STATES PATENT AND TRADEMARK OFFICE



In re Application of:
Jed Margolin
Serial No. 08/587,731
Filed: January 19, 1996
For: A Method and Apparatus for Remotely Piloting an Aircraft

Examiner: T. Nguyen
Art Unit: 3614

Patent
M. E. ...
8-12-98
14/C
[Signature]
[Signature]

PLEASE
ENTER
08/12/98
TN

RESPONSE UNDER 37 C.F.R. § 1.116
- EXPEDITED PROCEDURE -
EXAMINING GROUP 3614

Assistant Commissioner for Patents
Washington, D.C. 20231

RESPONSE UNDER 37 C.F.R. § 1.116
EXPEDITED PROCEDURE -- EXAMINING GROUP 3614

Sir:
Responsive to the Advisory Action mailed on July 24, 1998, the Applicant respectfully requests the Examiner to enter the following amendment and to consider the following remark:

AMENDMENT

In the Claims:
Please cancel Claims 24-38, 51 and 52 without prejudice.

and 53

TN
8/12/98

RECEIVED
TECHNICAL SERVICES CENTER 3600
53 AUG 11 PM 2:41

REMARK

The Advisory Action has indicated that claims 1-9, 12-18, 21-23, and 50 are allowable and that claims 24-38, 51 and 52 remain rejected. Although Applicant disagrees

FIRST CLASS CERTIFICATE OF MAILING

I hereby certify that this correspondence is being deposited with the United States Postal Service as first class mail with sufficient postage in an envelope addressed to the Assistant Commissioner for Patents, Washington, D.C. 20231 on

August 4, 1998
(Date of Deposit)

Conny Van Dalen
Name of Person Mailing Correspondence

Conny Van Dalen
Signature

8-4-98
Date

01652

with the rejection, Applicant has canceled claims 24-38, 51 and 52 to place the application in condition for allowance. Applicant currently plans on filing a continuation to further pursue the rejected claims.

Invitation for a telephone interview

The Examiner is invited to call the undersigned at 408-720-8598 if there remains any issue with allowance of this case.

Charge our Deposit Account

Please charge any shortage to our Deposit Account No. 02-2666.

Respectfully submitted,

BLAKELY, SOKOLOFF, TAYLOR & ZAFMAN LLP

Date: 8/4, 1998

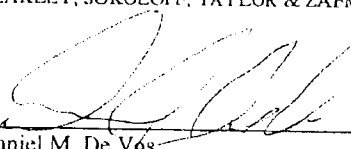
Daniel M. De Vés
Reg. No. 37,813

12400 Wilshire Boulevard
Seventh Floor
Los Angeles, California 90025-1026
(408) 720-8598

01653



Corres. and Mail
BOX AF

AF/3614

Attorney's Docket No.: 002055.P004 Patent

In re the Application of: Jed Margolin AMENDMENT UNDER
(inventor(s)) 37 C.F.R. § 1.116

Application No.: 08/587,731 EXPEDITED PROCEDURE

Filed: January 19, 1996 EXAMINING GROUP 3614

For: A Method and Apparatus for Remotely Piloting an Aircraft

(title)

ASSISTANT COMMISSIONER FOR PATENTS
Washington, D.C. 20231
Box AF

SIR: Transmitted herewith is an **Amendment After Final Action** for the above application.

- Small entity status of this application under 37 C.F.R. §§ 1.9 and 1.27 has been established by a verified statement previously submitted.
- A verified statement to establish small entity status under 37 C.F.R. §§ 1.9 and 1.27 is enclosed. No additional fee is required.
- A Notice of Appeal is enclosed.**

The fee has been calculated as shown below:

	(Col. 1)		(Col. 2)		(Col. 3)	SMALL ENTITY		OTHER THAN A SMALL ENTITY	
	Claims Remaining After Amd.		Highest No. Previously Paid For		Present Extra	Rate	Additional Fee	Rate	Additional Fee
Total Claims	* 21	Minus	** 49		0	x11	\$ 0	x22	\$
Indep. Claims	* 2	Minus	*** 5		0	x41	\$ 0	x82	\$
First Presentation of Multiple Dependent Claim(s)						+135	\$ 0	+270	\$
<ul style="list-style-type: none"> * If the entry in Col. 1 is less than the entry in Col. 2, write "0" in Col. 3. ** If the "Highest No. Previously Paid For" IN THIS SPACE is less than 20, write "20" in this space. *** If the "Highest No. Previously Paid For" IN THIS SPACE is less than 3, write "3" in this space. The "Highest No. Previously Paid For" (Total or Independent) is the highest number found from the equivalent box in Col. 1 of a prior amendment or the number of claims originally filed. 						Total Add. Fee	\$ 0	Total Add. Fee	\$

I hereby certify that this correspondence is being deposited with the United States Postal Service as first class mail with sufficient postage in an envelope addressed to the Assistant Commissioner for Patents, Washington, D.C. 20231

on August 4, 1998
Date of Deposit

Conny Van Dalen
Name of Person Mailing Correspondence

Conny Van Dalen Signature 8-4-98 Date

RECEIVED
 AUG 11 11 24 AM '98
 58 AUG 11

_____ A check in the amount of \$ _____ is attached for presentation of additional claim(s).
_____ Applicant(s) hereby Petition(s) for an Extension of Time of _____ month(s) pursuant to
37 C.F.R. § 1.136(a).

_____ A check for \$ _____ is attached for processing fees under 37 C.F.R. § 1.17.

_____ Please charge my Deposit Account No. 02-2666 the amount of \$ _____.

A duplicate copy of this sheet is enclosed.

The Commissioner of Patents and Trademarks is hereby authorized to charge payment of the
following fees associated with this communication or credit any overpayment to Deposit Account
No. 02-2666 (a duplicate copy of this sheet is enclosed):

Any additional filing fees required under 37 C.F.R. § 1.16 for presentation of
extra claims.

Any extension or petition fees under 37 C.F.R. § 1.17.

BLAKELY SOKOLOFF TAYLOR & ZAFMAN LLP

Date: 3/4 1998

12400 Wilshire Boulevard
Seventh Floor
Los Angeles, California 90025
(408) 720-8598



Daniel M. De Vos

Reg. No. 37,813

01655

**ACCESS ACKNOWLEDGMENT
and
SECURITY ORDER RECOMMENDATION BY DEFENSE AGENCY**

Application Serial No.: 08/587,731

Defense Agency: Navy

Filing Date: 01/19/96

Date Referred: 03/18/96

I hereby acknowledge as indicated by my signature on this form that I have inspected this application in administration of 35 USC 181 on behalf of the Agency/Command specified below. I promise not to divulge any information from this application for any purpose other than administration of 35 USC 181.

Recommendation

(e.g., 'Security Not Recommended (SNR)')

Reviewer(s) Signature/Date/Command

<i>SNR</i>	<i>Ana Cluff 5/23/96 NAVY</i>
------------	-------------------------------

Instructions to Reviewers:

1. All individuals reviewing this application are required under 35 USC 181 to sign and date this form regardless of whether they are making a security order recommendation.
2. The attached copy of the application, any copies made therefrom and this form must be returned to the PTO once a recommendation not to impose secrecy has been made or a security order has been rescinded.

Time for Completion of Review:

Pursuant to 35 U.S.C. 184, the subject matter of this application may be filed in a foreign country for the purpose of filing a patent application without a license any time after the expiration of 6 months from filing date unless the application becomes the subject of a security order.



01656

*cl
5/23/96*

**ACCESS ACKNOWLEDGMENT
and
SECURITY ORDER RECOMMENDATION BY DEFENSE AGENCY**

Application Serial No.: 08/587,731

Defense Agency: AirForce

Filing Date: 01/19/96

Date Referred: 03/18/96

I hereby acknowledge as indicated by my signature on this form that I have inspected this application in administration of 35 USC 181 on behalf of the Agency/Command specified below. I promise not to divulge any information from this application for any purpose other than administration of 35 USC 181.

Recommendation

(e.g., 'Security Not Recommended (SNR)')

Reviewer(s) Signature/Date/Command

<i>No security Recommended</i>	<i>M. Jordan, AUSA/TK-AP, 26 March 96</i>
------------------------------------	---

Instructions to Reviewers:

1. All individuals reviewing this application are required under 35 USC 181 to sign and date this form regardless of whether they are making a security order recommendation.
2. The attached copy of the application, any copies made therefrom and this form must be returned to the PTO once a recommendation not to impose secrecy has been made or a security order has been rescinded.

Time for Completion of Review:

Pursuant to 35 U.S.C. 184, the subject matter of this application may be filed in a foreign country for the purpose of filing a patent application without a license any time after the expiration of 6 months from filing date unless the application becomes the subject of a security order.



4/3/96 JCB

01657

Interview Summary

Application No. 08/587,731	Applicant(s) MARGOLIN
Examiner TAN Q. NGUYEN	Group Art Unit 3614

All participants (applicant, applicant's representative, PTO personnel):

- (1) TAN Q. NGUYEN (3) _____
(2) DANIEL M DE VOS (4) _____

Date of Interview 8/20/98

Type: Telephonic Personal (copy is given to applicant applicant's representative).

Exhibit shown or demonstration conducted: Yes No. If yes, brief description:

Agreement was reached. was not reached.

Claim(s) discussed: 53

Identification of prior art discussed:
NONE

Description of the general nature of what was agreed to if an agreement was reached, or any other comments:
CLAIM 53 IS REQUESTED TO BE CANCELED SINCE IT DEPENDS ON CLAIM 34 WHICH WAS CANCELED. THE AGREEMENT WAS REACHED.

(A fuller description, if necessary, and a copy of the amendments, if available, which the examiner agreed would render the claims allowable must be attached. Also, where no copy of the amendments which would render the claims allowable is available, a summary thereof must be attached.)

1. It is not necessary for applicant to provide a separate record of the substance of the interview.

Unless the paragraph above has been checked to indicate to the contrary, A FORMAL WRITTEN RESPONSE TO THE LAST OFFICE ACTION IS NOT WAIVED AND MUST INCLUDE THE SUBSTANCE OF THE INTERVIEW. (See MPEP Section 713.04). If a response to the last Office action has already been filed, APPLICANT IS GIVEN ONE MONTH FROM THIS INTERVIEW DATE TO FILE A STATEMENT OF THE SUBSTANCE OF THE INTERVIEW.

2. Since the Examiner's interview summary above (including any attachments) reflects a complete response to each of the objections, rejections and requirements that may be present in the last Office action, and since the claims are now allowable, this completed form is considered to fulfill the response requirements of the last Office action. Applicant is not relieved from providing a separate record of the interview unless box 1 above is also checked.

Examiner Note: You must sign and stamp this form unless it is an attachment to a signed Office action.

08/587,731



**UNITED STATES DEPARTMENT OF COMMERCE
Patent and Trademark Office**

Address: COMMISSIONER OF PATENTS AND TRADEMARKS
Washington, D.C. 20231

APPLICATION NO.	FILING DATE	FIRST NAMED INVENTOR	ATTORNEY DOCKET NO.
08/587,731	01/19/96	MARGOLIN	J 002055.P004

PM21/0824
 BLAKELY SOKOLOFF TAYLOR AND ZAFMAN
 12400 WILSHIRE BOULEVARD
 7TH FLOOR
 LOS ANGELES CA 90025

EXAMINER

NGUYEN, T

ART UNIT	PAPER NUMBER
3614	16

DATE MAILED:

08/24/98

Please find below and/or attached an Office communication concerning this application or proceeding.

Commissioner of Patents and Trademarks

Tan Q. Nguyen
 TAN Q. NGUYEN
 PATENT EXAMINER

01659

Notice of Allowability

Application No. 08/587,731	Applicant(s) MARGOLIN
Examiner TAN Q. NGUYEN	Group Art Unit 3614



All claims being allowable, PROSECUTION ON THE MERITS IS (OR REMAINS) CLOSED in this application. If not included herewith (or previously mailed), a Notice of Allowance and Issue Fee Due or other appropriate communication will be mailed in due course.

- This communication is responsive to 08/07/98 and 08/20/98
- The allowed claim(s) is/are 1-9, 10-17, 21-23, and 50 (now renumbered as 1-20)
- The drawings filed on _____ are acceptable.
- Acknowledgement is made of a claim for foreign priority under 35 U.S.C. § 119(a)-(d).
- All Some* None of the CERTIFIED copies of the priority documents have been
- received.
- received in Application No. (Series Code/Serial Number) _____
- received in this national stage application from the International Bureau (PCT Rule 17.2(a)).
- *Certified copies not received: _____
- Acknowledgement is made of a claim for domestic priority under 35 U.S.C. § 119(e).

A SHORTENED STATUTORY PERIOD FOR RESPONSE to comply with the requirements noted below is set to EXPIRE THREE MONTHS FROM THE "DATE MAILED" of this Office action. Failure to timely comply will result in ABANDONMENT of this application. Extensions of time may be obtained under the provisions of 37 CFR 1.136(a).

- Note the attached EXAMINER'S AMENDMENT or NOTICE OF INFORMAL APPLICATION, PTO-152, which discloses that the oath or declaration is deficient. A SUBSTITUTE OATH OR DECLARATION IS REQUIRED.
- Applicant MUST submit NEW FORMAL DRAWINGS
- because the originally filed drawings were declared by applicant to be informal.
- including changes required by the Notice of Draftsperson's Patent Drawing Review, PTO-948, attached hereto or to Paper No. 3.
- including changes required by the proposed drawing correction filed on _____, which has been approved by the examiner.
- including changes required by the attached Examiner's Amendment/Comment.

Identifying indicia such as the application number (see 37 CFR 1.84(c)) should be written on the reverse side of the drawings. The drawings should be filed as a separate paper with a transmittal letter addressed to the Official Draftsperson.

- Note the attached Examiner's comment regarding REQUIREMENT FOR THE DEPOSIT OF BIOLOGICAL MATERIAL.

Any response to this letter should include, in the upper right hand corner, the APPLICATION NUMBER (SERIES CODE/SERIAL NUMBER). If applicant has received a Notice of Allowance and Issue Fee Due, the ISSUE BATCH NUMBER and DATE of the NOTICE OF ALLOWANCE should also be included.

Attachment(s)

- Notice of References Cited, PTO-892
- Information Disclosure Statement(s), PTO-1449, Paper No(s) _____
- Notice of Draftsperson's Patent Drawing Review, PTO-948
- Notice of Informal Patent Application, PTO-152
- Interview Summary, PTO-413
- Examiner's Amendment/Comment
- Examiner's Comment Regarding Requirement for Deposit of Biological Material
- Examiner's Statement of Reasons for Allowance

TAN Q. NGUYEN
PRIMARY EXAMINER
ART UNIT 3614



UNITED STATES DEPARTMENT OF COMMERCE
Patent and Trademark Office

NOTICE OF ALLOWANCE AND ISSUE FEE DUE

PTOL/9804
CLARIFY DUALITY DATE OR AND TERMED
1980-81 CLASS. EXAMINED
PTO FLOOR
1001 WASHINGTON BLVD

APPLICATION NO.	FILING DATE	TOTAL CLAIMS	EXAMINER AND GROUP ART UNIT	DATE MAILED
001257-001	01/11/88	004	ROBERT J. ...	02/14/88
First Named Applicant: MARCEL ...				

TITLE OF INVENTION
METHOD AND APPARATUS FOR RECEIVING SIGNALS BY AIRCRAFT

ATTY'S DOCKET NO.	CLASS-SUBCLASS	BATCH NO.	APPLN. TYPE	SMALL ENTITY	FEE DUE	DATE DUE
001257-001	01/11/88	004	UTILITY	YES	\$250.00	04/14/88

THE APPLICATION IDENTIFIED ABOVE HAS BEEN EXAMINED AND IS ALLOWED FOR ISSUANCE AS A PATENT. PROSECUTION ON THE MERITS IS CLOSED.

THE ISSUE FEE MUST BE PAID WITHIN THREE MONTHS FROM THE MAILING DATE OF THIS NOTICE OR THIS APPLICATION SHALL BE REGARDED AS ABANDONED. THIS STATUTORY PERIOD CANNOT BE EXTENDED.

HOW TO RESPOND TO THIS NOTICE:

- I. Review the SMALL ENTITY status shown above.
 - If the SMALL ENTITY is shown as YES, verify your current SMALL ENTITY status:
 - A. If the status is changed, pay twice the amount of the FEE DUE shown above and notify the Patent and Trademark Office of the change in status, or
 - B. If the status is the same, pay the FEE DUE shown above.
 - If the SMALL ENTITY is shown as NO:
 - A. Pay FEE DUE shown above, or
 - B. File verified statement of Small Entity Status before, or with, payment of 1/2 the FEE DUE shown above.
- II. Part B-Issue Fee Transmittal should be completed and returned to the Patent and Trademark Office (PTO) with your ISSUE FEE. Even if the ISSUE FEE has already been paid by charge to deposit account, Part B Issue Fee Transmittal should be completed and returned. If you are charging the ISSUE FEE to your deposit account, section "4b" of Part B-Issue Fee Transmittal should be completed and an extra copy of the form should be submitted.
- III. All communications regarding this application must give application number and batch number. Please direct all communications prior to issuance to Box ISSUE FEE unless advised to the contrary.

IMPORTANT REMINDER: Utility patents issuing on applications filed on or after Dec. 12, 1980 may require payment of maintenance fees. It is patentee's responsibility to ensure timely payment of maintenance fees when due.

PATENT AND TRADEMARK OFFICE COPY

28/587,731



**UNITED STATES DEPARTMENT OF COMMERCE
Patent and Trademark Office**

Address: COMMISSIONER OF PATENTS AND TRADEMARKS
Washington, D.C. 20231

APPLICATION NO.	FILING DATE	FIRST NAMED INVENTOR	ATTORNEY DOCKET NO.
087587-731	01/19/96	MARGOLIN	882055-100

PM52/1201
 BLAKELY SOKOLOFF TAYLOR AND ZAFMAN
 12400 WILSHIRE BOULEVARD
 7TH FLOOR
 LOS ANGELES CA 90025

EXAMINER NGUYEN, T

ART UNIT 3614	PAPER NUMBER
------------------	--------------

DATE MAILED: 12/07/98

Please find below and/or attached an Office communication concerning this application or proceeding.

Commissioner of Patents and Trademarks

Tan Q. Nguyen
 TAN Q. NGUYEN
 PATENT EXAMINER

01662

Supplemental
Notice of Allowability

Application No. 08/587,731	Applicant(s) MARGOLIN
Examiner TAN Q. NGUYEN	Group Art Unit 3661



All claims being allowable, PROSECUTION ON THE MERITS IS (OR REMAINS) CLOSED in this application. If not included herewith (or previously mailed), a Notice of Allowance and Issue Fee Due or other appropriate communication will be mailed in due course.

- This communication is responsive to 09/03/98
- The allowed claim(s) is/are 1-9, 10-17, 21-23, and 50 (now renumbered as 1-20)
- The drawings filed on 1/19/96 are acceptable.
- Acknowledgement is made of a claim for foreign priority under 35 U.S.C. § 119(a)-(d).
 - All Some* None of the CERTIFIED copies of the priority documents have been
 - received.
 - received in Application No. (Series Code/Serial Number) _____
 - received in this national stage application from the International Bureau (PCT Rule 17.2(a)).
- *Certified copies not received: _____
- Acknowledgement is made of a claim for domestic priority under 35 U.S.C. § 119(a).

A SHORTENED STATUTORY PERIOD FOR RESPONSE to comply with the requirements noted below is set to EXPIRE THREE MONTHS FROM THE "DATE MAILED" of this Office action. Failure to timely comply will result in ABANDONMENT of this application. Extensions of time may be obtained under the provisions of 37 CFR 1.136(a).

- Note the attached EXAMINER'S AMENDMENT or NOTICE OF INFORMAL APPLICATION, PTO-152, which discloses that the oath or declaration is deficient. A SUBSTITUTE OATH OR DECLARATION IS REQUIRED.
- Applicant MUST submit NEW FORMAL DRAWINGS
 - because the originally filed drawings were declared by applicant to be informal.
 - including changes required by the Notice of Draftsperson's Patent Drawing Review, PTO-948, attached hereto or to Paper No. _____
 - including changes required by the proposed drawing correction filed on _____, which has been approved by the examiner.
 - including changes required by the attached Examiner's Amendment/Comment.

Identifying indicia such as the application number (see 37 CFR 1.84(c)) should be written on the reverse side of the drawings. The drawings should be filed as a separate paper with a transmittal letter addressed to the Official Draftsperson.

- Note the attached Examiner's comment regarding REQUIREMENT FOR THE DEPOSIT OF BIOLOGICAL MATERIAL.

Any response to this letter should include, in the upper right hand corner, the APPLICATION NUMBER (SERIES CODE/SERIAL NUMBER). If applicant has received a Notice of Allowance and Issue Fee Due, the ISSUE BATCH NUMBER and DATE of the NOTICE OF ALLOWANCE should also be included.

Attachment(s)

- Notice of References Cited, PTO-892
- Information Disclosure Statement(s), PTO-1449, Paper No(s). _____
- Notice of Draftsperson's Patent Drawing Review, PTO-948
- Notice of Informal Patent Application, PTO-152
- Interview Summary, PTO-413
- Examiner's Amendment/Comment
- Examiner's Comment Regarding Requirement for Deposit of Biological Material
- Examiner's Statement of Reasons for Allowance

Tan Nguyen
TAN Q. NGUYEN
PRIMARY EXAMINER
ART UNIT 3661

NOTICE OF DRAFTSPERSON'S PATENT DRAWING REVIEW

The drawing(s) filed (insert date) 11/19/96 are:

- A. approved by the Draftsperson under 37 CFR 1.84 or 1.152.
- B. objected to by the Draftsperson under 37 CFR 1.84 or 1.152 for the reasons indicated below. The Examiner will require submission of new, corrected drawings when necessary. Corrected drawing must be submitted according to the instructions on the back of this notice.

<p>1. DRAWINGS. 37 CFR 1.84(a): Acceptable categories of drawings: Black ink. Color. <input type="checkbox"/> Color drawings are not acceptable until petition is granted. Fig(s) _____ <input type="checkbox"/> Pencil and non black ink not permitted. Fig(s) _____</p> <p>2. PHOTOGRAPHS. 37 CFR 1.84 (b) <input type="checkbox"/> 1 full-tone set is required. Fig(s) _____ <input type="checkbox"/> Photographs not properly mounted (must use bristol board or photographic double-weight paper). Fig(s) _____ <input type="checkbox"/> Four quality (half-tone). Fig(s) _____</p> <p>3. TYPE OF PAPER. 37 CFR 1.84(e) <input type="checkbox"/> Paper not flexible, strong, white, and durable. Fig(s) _____ <input type="checkbox"/> Erasures, alterations, overwritings, interlineations, folds, copy machine marks not accepted. Fig(s) _____ <input type="checkbox"/> Mylar, velum paper is not acceptable (too thin). Fig(s) _____</p> <p>4. SIZE OF PAPER. 37 CFR 1.84(f): Acceptable sizes: <input type="checkbox"/> 21.0 cm by 29.7 cm (DIN size A4) <input type="checkbox"/> 21.6 cm by 27.9 cm (8 1/2 x 11 inches) <input type="checkbox"/> All drawing sheets not the same size. <input type="checkbox"/> Sheet(s) _____ <input type="checkbox"/> Drawings sheets not an acceptable size. Fig(s) _____</p> <p>5. MARGINS. 37 CFR 1.84(g): Acceptable margins: Top 2.5 cm Left 2.5cm Right 1.5 cm Bottom 1.0 cm SIZE: A4 Size Top 2.5 cm Left 2.5 cm Right 1.5 cm Bottom 1.0 cm SIZE: 8 1/2 x 11 Margins not acceptable. Fig(s) _____ <input type="checkbox"/> Top (T) _____ Left (L) _____ <input type="checkbox"/> Right (R) _____ Bottom (B) _____</p> <p>6. VIEWS. 37 CFR 1.84(h) REMINDER: Specification may require revision to correspond to drawing changes. Partial views. 37 CFR 1.84(h)(2) <input type="checkbox"/> Brackets needed to show figure as one entity. Fig(s) _____ <input type="checkbox"/> Views not labeled separately or properly. Fig(s) _____ <input type="checkbox"/> Enlarged view not labeled separately or properly. Fig(s) _____</p> <p>7. SECTIONAL VIEWS. 37 CFR 1.84 (h)(3) <input type="checkbox"/> Hatching not indicated for sectional portions of an object. Fig(s) _____ <input type="checkbox"/> Sectional designation should be noted with Arabic or Roman numbers. Fig(s) _____</p>	<p>8. ARRANGEMENT OF VIEWS. 37 CFR 1.84(i) <input type="checkbox"/> Words do not appear on a horizontal, left-to-right fashion when page is either upright or turned so that the top becomes the right side, except for graphs. Fig(s) _____</p> <p>9. SCALE. 37 CFR 1.84(k) <input type="checkbox"/> Scale not large enough to show mechanism without crowding when drawing is reduced in size to two-thirds in reproduction. Fig(s) _____</p> <p>10. CHARACTER OF LINES, NUMBERS, & LETTERS. 37 CFR 1.84(j) <input type="checkbox"/> Lines, numbers & letters not uniformly thick and well defined, clean, durable, and black (poor line quality). Fig(s) _____</p> <p>11. SHADING. 37 CFR 1.84(m) <input type="checkbox"/> Solid black areas pale. Fig(s) _____ <input type="checkbox"/> Solid black shading not permitted. Fig(s) _____ <input type="checkbox"/> Shade lines, pale, rough and blurred. Fig(s) _____</p> <p>12. NUMBERS, LETTERS, & REFERENCE CHARACTERS. 37 CFR 1.84(p) <input type="checkbox"/> Numbers and reference characters not plain and legible. Fig(s) _____ <input type="checkbox"/> Figure legends are poor. Fig(s) _____ <input type="checkbox"/> Numbers and reference characters not oriented in the same direction as the view. 37 CFR 1.84(p)(1) Fig(s) _____ <input type="checkbox"/> English alphabet not used. 37 CFR 1.84(p)(2) Fig(s) _____ <input type="checkbox"/> Numbers, letters and reference characters must be at least .32 cm (1/8 inch) in height. 37 CFR 1.84(p)(3) Fig(s) _____</p> <p>13. LEAD LINES. 37 CFR 1.84(q) <input type="checkbox"/> Lead lines cross each other. Fig(s) _____ <input type="checkbox"/> Lead lines missing. Fig(s) _____</p> <p>14. NUMBERING OF SHEETS OF DRAWINGS. 37 CFR 1.84(l) <input type="checkbox"/> Sheets not numbered consecutively, and in Arabic numerals beginning with number 1. Sheet(s) _____</p> <p>15. NUMBERING OF VIEWS. 37 CFR 1.84(u) <input type="checkbox"/> Views not numbered consecutively, and in Arabic numerals, beginning with number 1. Fig(s) _____</p> <p>16. CORRECTIONS. 37 CFR 1.84(w) <input type="checkbox"/> Corrections not made from prior PTO-948 dated _____</p> <p>17. DESIGN DRAWINGS. 37 CFR 1.152 <input type="checkbox"/> Surface shading shown not appropriate. Fig(s) _____ <input type="checkbox"/> Solid black shading not used for color contrast. Fig(s) _____</p>
<p>COMMENTS</p>	

REVIEWER A D. DATE 11/23/98 TELEPHONE NO. _____

ATTACHMENT TO PAPER NO. 17

PART B—ISSUE FEE TRANSMITTAL

242 - 605
301 - 30

Complete and mail this form, together with applicable fees, to: **Box ISSUE FEE Assistant Commissioner for Patents Washington, D.C. 20231**

MAILING INSTRUCTIONS: This form should be used for transmitting the ISSUE FEE. Blocks 1 through 4 should be completed where appropriate. All further correspondence including the Issue Fee Receipt, the Patent, advance orders and notification of maintenance fees will be mailed to the current correspondence address as indicated unless corrected below or directed otherwise in Block 1, by (a) specifying a new correspondence address; and/or (b) indicating a separate "FEE ADDRESS" for maintenance fee notifications.

Note: The certificate of mailing below can only be used for domestic mailings of the Issue Fee Transmittal. This certificate cannot be used for any other accompanying papers. Each additional paper, such as an assignment or formal drawing, must have its own certificate of mailing.

Certificate of Mailing

I hereby certify that this Issue Fee Transmittal is being deposited with the United States Postal Service with sufficient postage for first class mail in an envelope addressed to the Box Issue Fee address above on the date indicated below.

CURRENT CORRESPONDENCE ADDRESS (Note: Legibly mark-up with any corrections or use Block 1)

PM21/0824
BLAKELY SOKOLOFF TAYLOR AND ZAFMAN
12400 WILSHIRE BOULEVARD
7TH FLOOR
LOS ANGELES CA 90025

RECEIVED
Publishing Division
DEC 3 - 1998

Conny Van Dalen (Depositor's name)
Conny Van Dalen (Signature)

11-24-98 (Date)

APPLICATION NO.	FILING DATE	TOTAL CLAIMS	EXAMINER AND GROUP ART UNIT	DATE MAILED
05/587,701	01/19/96	16		06/24/98

TITLE OF INVENTION
MARCOLIN, JED
METHOD AND APPARATUS FOR REMOTELY PILOTING AN AIRCRAFT

ATTY'S DOCKET NO.	CLASS-SUBCLASS	BATCH NO.	APPLN. TYPE	SMALL ENTITY	FEE DUE	DATE DUE
000055, P004	701-120, 000	116	UTILITY	YES	\$660.00	11/24/98

1. Change of correspondence address or indication of "Fee Address" (37 CFR 1.363). Use of PTO form(s) and Customer Number are recommended, but not required.

- Change of correspondence address (or Change of Correspondence Address form PTO/SB/122) attached.
- "Fee Address" indication (or "Fee Address" indication form PTO/SB/47) attached.

2. For printing on the patent front page, list (1) the names of up to 3 registered patent attorneys or agents OR, alternatively, (2) the name of a single firm (having as a member a registered attorney or agent) and the names of up to 2 registered patent attorneys or agents. If no name is listed, no name will be printed.

1 Blakely, Sokoloff,
2 Taylor and Zafman LLP

3. ASSIGNEE NAME AND RESIDENCE DATA TO BE PRINTED ON THE PATENT (print or type)
PLEASE NOTE: Unless an assignee is identified below, no assignee data will appear on the patent. Inclusion of assignee data is only appropriate when an assignment has been previously submitted to the PTO or is being submitted under separate cover. Completion of this form is NOT a substitute for filing an assignment.

(A) NAME OF ASSIGNEE
(B) RESIDENCE: (CITY & STATE OR COUNTRY)

Please check the appropriate assignee category indicated below (will not be printed on the patent)
 Individual corporation or other private group entity government

4a. The following fees are enclosed (make check payable to Commissioner of Patents and Trademarks):

- Issue Fee
- Advance Order - # of Copies ten (10)

4b. The following fees or deficiency in these fees should be charged to:

DEPOSIT ACCOUNT NUMBER 02-2666
(ENCLOSE AN EXTRA COPY OF THIS FORM)
 Issue Fee
 Advance Order - # of Copies ten (10)

The COMMISSIONER OF PATENTS AND TRADEMARKS is requested to apply the Issue Fee to the application identified above.
(Authorized Signatory) Edwin H. Taylor, Reg. # 25,129 (Date) 11/24/98

NOTE: The Issue Fee will not be accepted from anyone other than the applicant; a registered attorney or agent; or the assignee or other party in interest as shown by the records of the Patent and Trademark Offices.

Burden Hour Statement: This form is estimated to take 0.2 hours to complete. Time will vary depending on the needs of the individual case. Any comments on the amount of time required to complete this form should be sent to the Chief Information Officer, Patent and Trademark Office, Washington, D.C. 20231. DO NOT SEND FEES OR COMPLETED FORMS TO THIS ADDRESS. SEND FEES AND THIS FORM TO: Box Issue Fee, Assistant Commissioner for Patents, Washington D.C. 20231

Under the Paperwork Reduction Act of 1995, no persons are required to respond to a collection of information unless it displays a valid OMB control number.

12/22/1998 RTBE:BYE 00000150 08587731

01 FC:242
02 FC:361
605.00 DP
30.00 DP

01665

TRANSMIT THIS FORM WITH FEE

PART B—ISSUE FEE TRANSMITTAL

Complete and mail this form, together with application fees, to: **Box ISSUE FEE
Assistant Commissioner for Patents
Washington, D.C. 20231**

MAILING INSTRUCTIONS: This form should be used for transmitting the ISSUE FEE. Blocks 1 through 4 should be completed where appropriate. All further correspondence including the Issue Fee Receipt, the Patent, advance orders and notification of maintenance fees will be mailed to the current correspondence address as indicated unless corrected below or directed otherwise in Block 1, by (a) specifying a new correspondence address; and/or (b) indicating a separate "FEE ADDRESS" for maintenance fee notifications.

CURRENT CORRESPONDENCE ADDRESS (Note: Legibly mark-up with any corrections or use Block 1)

PM21/0824

BLAKELY SOKOLOFF TAYLOR AND ZAFMAN
12400 WILSHIRE BOULEVARD
7TH FLOOR
LOS ANGELES CA 90025

Note: The certificate of mailing below can only be used for domestic mailings of the Issue Fee Transmittal. This certificate cannot be used for any other accompanying papers. Each additional paper, such as an assignment or formal drawing, must have its own certificate of mailing.

Certificate of Mailing

I hereby certify that this Issue Fee Transmittal is being deposited with the United States Postal Service with sufficient postage for first class mail in an envelope addressed to the Box Issue Fee address above on the date indicated below.

Conny Van Dalen (Depositor's name)

Conny Van Dalen (Signature)

11-24-98 (Date)

APPLICATION NO.	FILING DATE	TOTAL CLAIMS	EXAMINER AND GROUP ART UNIT	DATE MAILED
08/587,731	01/19/96	020	NGUYEN, T 3614	08/24/98
First Named Applicant: MARCOLEIN JED				

TITLE OF INVENTION
METHOD AND APPARATUS FOR REMOTELY PILOTING AN AIRCRAFT

ATTY'S DOCKET NO.	CLASS-SUBCLASS	BATCH NO.	APPLN. TYPE	SMALL ENTITY	FEE DUE	DATE DUE
002055, P004	741-120,000	116	UTILITY	YES	\$500.00	11/24/98

- Change of correspondence address or indication of "Fee Address" (37 CFR 1.363). Use of PTO form(s) and Customer Number are recommended, but not required.
 - Change of correspondence address (or Change of Correspondence Address form PTO/SB/122) attached.
 - "Fee Address" indication (or "Fee Address" indication form PTO/SB/47) attached.
- For printing on the patent front page, list (1) the names of up to 3 registered patent attorneys or agents OR, alternatively, (2) the name of a single firm (having as a member a registered attorney or agent) and the names of up to 2 registered patent attorneys or agents. If no name is listed, no name will be printed.

1. Blakely, Sokoloff,
2. Taylor and Zafman LLP
3.

- ASSIGNEE NAME AND RESIDENCE DATA TO BE PRINTED ON THE PATENT (print or type)

PLEASE NOTE: Unless an assignee is identified below, no assignee data will appear on the patent. Inclusion of assignee data is only appropriate when an assignment has been previously submitted to the PTO or is being submitted under separate cover. Completion of this form is NOT a substitute for filing an assignment.

(A) NAME OF ASSIGNEE

(B) RESIDENCE (CITY & STATE OR COUNTRY)

Please check the appropriate assignee category indicated below (will not be printed on the patent)

individual corporation or other private group entity government

- The following fees are enclosed (make check payable to Commissioner of Patents and Trademarks):
 - Issue Fee
 - Advance Order - # of Copies ten (10)

- The following fees or deficiency in these fees should be charged to:

DEPOSIT ACCOUNT NUMBER 02-2666
(ENCLOSE AN EXTRA COPY OF THIS FORM)

 - Issue Fee
 - Advance Order - # of Copies ten (10)

The COMMISSIONER OF PATENTS AND TRADEMARKS IS requested to apply the Issue Fee to the application identified above.

(Authorized Signature) *Edwin H. Taylor*, Reg. #25,129 (Date) 11/24/98

NOTE: The Issue Fee will not be accepted from anyone other than the applicant, a registered attorney or agent, or the assignee or other party in interest as shown by the records of the Patent and Trademark Office.

Burden Hour Statement: This form is estimated to take 0.2 hours to complete. Time will vary depending on the needs of the individual case. Any comments on the amount of time required to complete this form should be sent to the Chief Information Officer, Patent and Trademark Office, Washington, D.C. 20231. DO NOT SEND FEES OR COMPLETED FORMS TO THIS ADDRESS. SEND FEES AND THIS FORM TO: Box Issue Fee, Assistant Commissioner for Patents, Washington D.C. 20231

Under the Paperwork Reduction Act of 1995, no persons are required to respond to a collection of information unless it displays a valid OMB control number.

ORIGINAL SIGNED BY

01666

TRANSMIT THIS FORM WITH FEE



UNITED STATES DEPARTMENT OF COMMERCE
Patent and Trademark Office

ASSISTANT SECRETARY AND COMMISSIONER
OF PATENTS AND TRADEMARKS
Washington, D.C. 20231

CHANGE OF ADDRESS/POWER OF ATTORNEY

FILE LOCATION 9200 SERIAL NUMBER 08587731 PATENT NUMBER 5904724

THE CORRESPONDENCE ADDRESS HAS BEEN CHANGED TO CUSTOMER # 23497

THE FEE ADDRESS HAS BEEN CHANGED TO CUSTOMER # 23497

ON 08/11/00 THE ADDRESS OF RECORD FOR CUSTOMER NUMBER 23497 IS:

JED MARGOLIN
3570 PLEASANT ECHO DRIVE
SAN JOSE CA 95148-1916

PTO INSTRUCTIONS: PLEASE TAKE THE FOLLOWING ACTION WHEN THE
CORRESPONDENCE ADDRESS HAS BEEN CHANGED TO CUSTOMER NUMBER:
RECORD, ON THE NEXT AVAILABLE CONTENTS LINE OF THE FILE JACKET,
'ADDRESS CHANGE TO CUSTOMER NUMBER'. LINE THROUGH THE OLD
ADDRESS ON THE FILE JACKET LABEL AND ENTER ONLY THE 'CUSTOMER
NUMBER' AS THE NEW ADDRESS. FILE THIS LETTER IN THE FILE JACKET.
WHEN ABOVE CHANGES ARE ONLY TO FEE ADDRESS AND/OR PRACTITIONERS
OF RECORD, FILE LETTER IN THE FILE JACKET.
THIS FILE IS ASSIGNED TO GAU 3614.

01667



UNITED STATES DEPARTMENT OF COMMERCE
Patent and Trademark Office
Address: COMMISSIONER OF PATENT AND TRADEMARKS
Washington, D.C. 20231

APPLICATION NUMBER	FILING DATE	FIRST NAMED APPLICANT	ATTY. DOCKET NO./TITLE
08/587,731	01/19/1996	JED MARGOLIN	002055.P004

23497
JED MARGOLIN
3570 PLEASANT ECHO DRIVE
SAN JOSE, CA 951481916

5904724

Date Mailed: 08/03/2000

NOTICE REGARDING POWER OF ATTORNEY

This is in response to the Power of Attorney filed 07/02/2000.

The Power of Attorney in this application is accepted. Correspondence in this application will be mailed to the above address as provided by 37 CFR 1.33.

Customer Service Center
Initial Patent Examination Division (703) 308-1202

OFFICE COPY



3661

5.904.754

Please type a plus sign (+) inside this box →

PTO/SB/82 (11-96)

Approved for use through 6/30/99. OMB 0651-0035
Patent and Trademark Office, U.S. DEPARTMENT OF COMMERCE

Under the Paperwork Reduction Act of 1995, no persons are required to respond to a collection of information unless it displays a valid OMB control number.

REVOCAION OF POWER OF ATTORNEY OR AUTHORIZATION OF AGENT	Application Number	08/587,731
	Filing Date	01-19-1996
	First Named Inventor	Jed Margolin
	Group Art Unit	3614
	Examiner Name	NGUYEN, TAN QUAN
	Attorney Docket Number	

I hereby revoke all previous powers of attorney or authorizations of agent given in the above-identified application:

A Power of Attorney or Authorization of Agent is submitted herewith.

OR

Please change the correspondence address for the above-identified application to:

Customer Number →

OR

Firm or Individual Name

Address

Address

City

Country State ZIP

Telephone Fax

I am the:

Applicant.

Assignee of record of the entire interest
Certificate under 37 CFR 3.73(b) is enclosed

SIGNATURE of Applicant or Assignee of Record

Name	Jed Margolin
Signature	<i>Jed Margolin</i>
Date	<i>6-30-00</i>

Business Hour Statement: This form is estimated to take 0.2 hours to complete. Time will vary depending upon the needs of the individual case. Any comments on the amount of time you are required to complete this form should be sent to the Chief Information Officer, Patent and Trademark Office, Washington, DC 20231. DO NOT SEND FEES OR COMPLETED FORMS TO THIS ADDRESS. SEND TO: Assistant Commissioner for Patents, Washington, DC 20231.

01669

J. Margolin
3570 Pleasant Echo Dr.
San Jose, CA 95148-1916



Assistant Commissioner for Patents
Washington, D.C. 20231

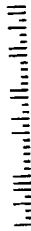

002
26 JUN 2000
SAN JOSE, CA

01670

002055.P004

4100
9.28-98

Patent

IN THE UNITED STATES PATENT AND TRADEMARK OFFICE

<p>In re Application of: Jed Margolin</p> <p>Application No. 08/587,731</p> <p>Filed: January 19, 1996</p> <p>For: A Method and Apparatus for Remotely Piloting an Aircraft</p>

Examiner: T. Nguyen

Art Unit: 3614

Issue Batch No.: I16

Notice of Allowance: 8/24/98

RECEIVED
Publication Division
SEP 03 1998

07

SUBMISSION OF FORMAL DRAWINGS

Official Draftsman
Washington, DC 20231

Dear Sir:

Applicant respectfully requests that the objection to the shading in Figure 7 be withdrawn because: 1) the shading aids in understanding the invention; and 2) the inventor has no other way of generating the figures. According to 37 C.F.R. 1.84(m) "the use of shading in views is encouraged if it aids in the understanding of the invention... Flat parts may also be lightly shaded. Such shading is preferred in the case of parts shown in perspective..." Figure 7 illustrates the projections that can be produced from the database in accordance with the invention. The shading is used for depth cueing, and therefore aids in the understanding of the invention by augmenting the perspective views provided.

Respectfully submitted,
BLAKELY, SOKOLOFF, TAYLOR & ZAFMAN LLP

Date: 8/31 1998

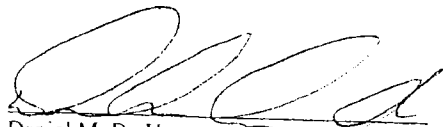
Daniel M. De Vos
Registration No. 37.813

12400 Wilshire Blvd.
Seventh Floor
Los Angeles, CA 90025-1026
(408) 720-8598

I hereby certify that this correspondence is being deposited with the United States Postal Service as first class mail with sufficient postage in an envelope addressed to the Assistant Commissioner for Patents, Washington, D.C. 20231

On August 31, 1998
 Date of Deposit
Conny Van Dalen
 Name of Person Mailing Correspondence
Conny Van Dalen 8-31-98
 Signature Date

01671

APPROVED	O.G. FIG. 3, 4	
BY	CLASS	SUBCLASS
DRAFTSMAN	701	120

5904724

DR/587731

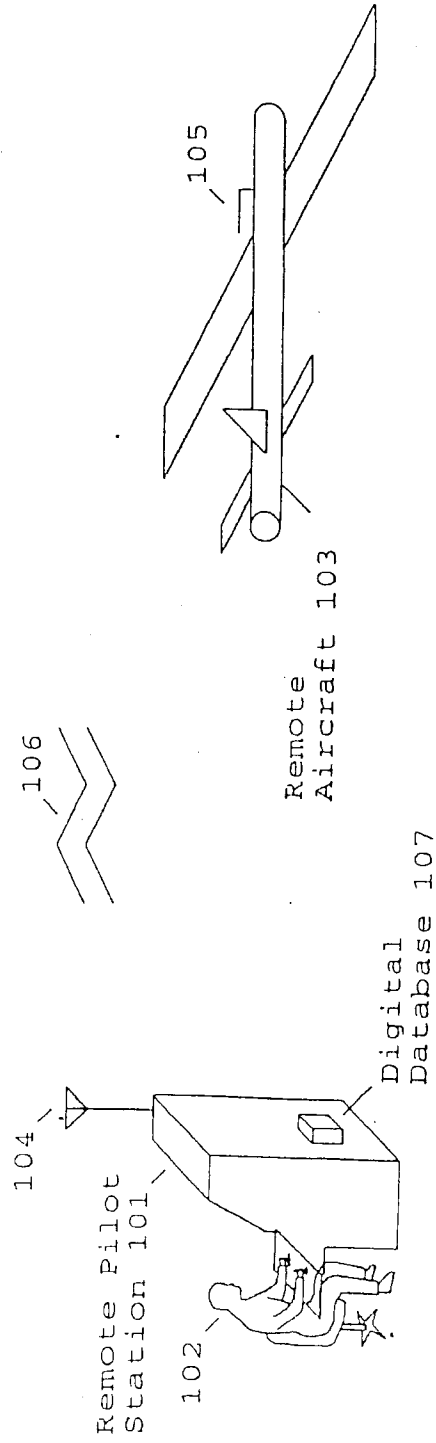

Fig. 1

APPROVED	O.G. FIG.	
BY	CLASS	SUBCLASS
DRAFTSMAN		

DR/587731

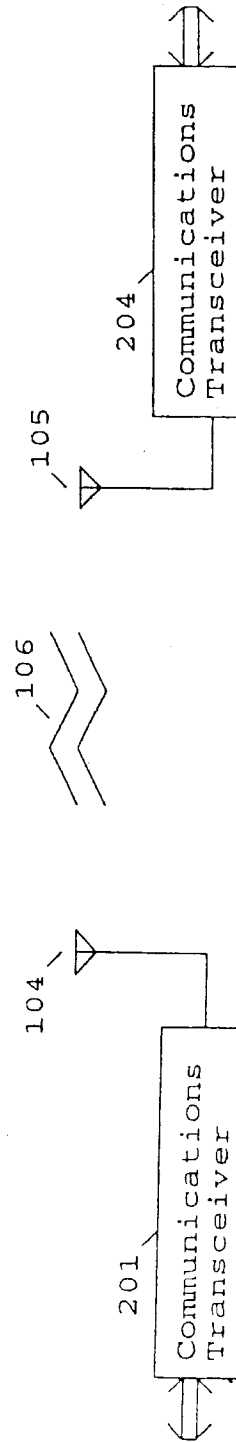

Fig. 2

APPROVED	O.G. FIGs. 3,4	
BY	CLASS	SUBCLASS
DRAFTSMAN	701	120

DR/587731

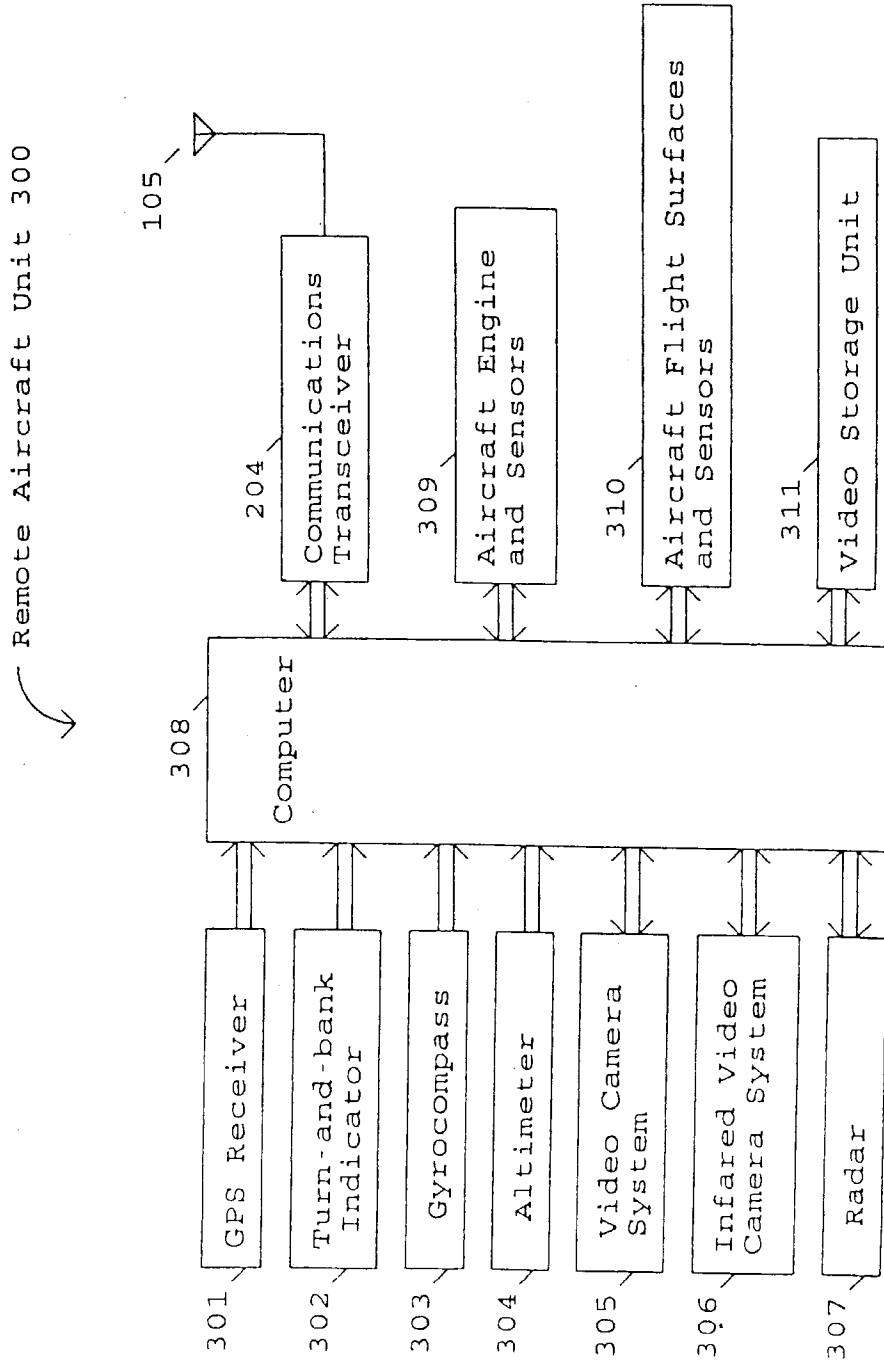

Fig. 3

APPROVED	O.G. FIG. 3,4	
BY	CLASS	SUBCLASS
DRAFTSMAN	701	120

08/587731

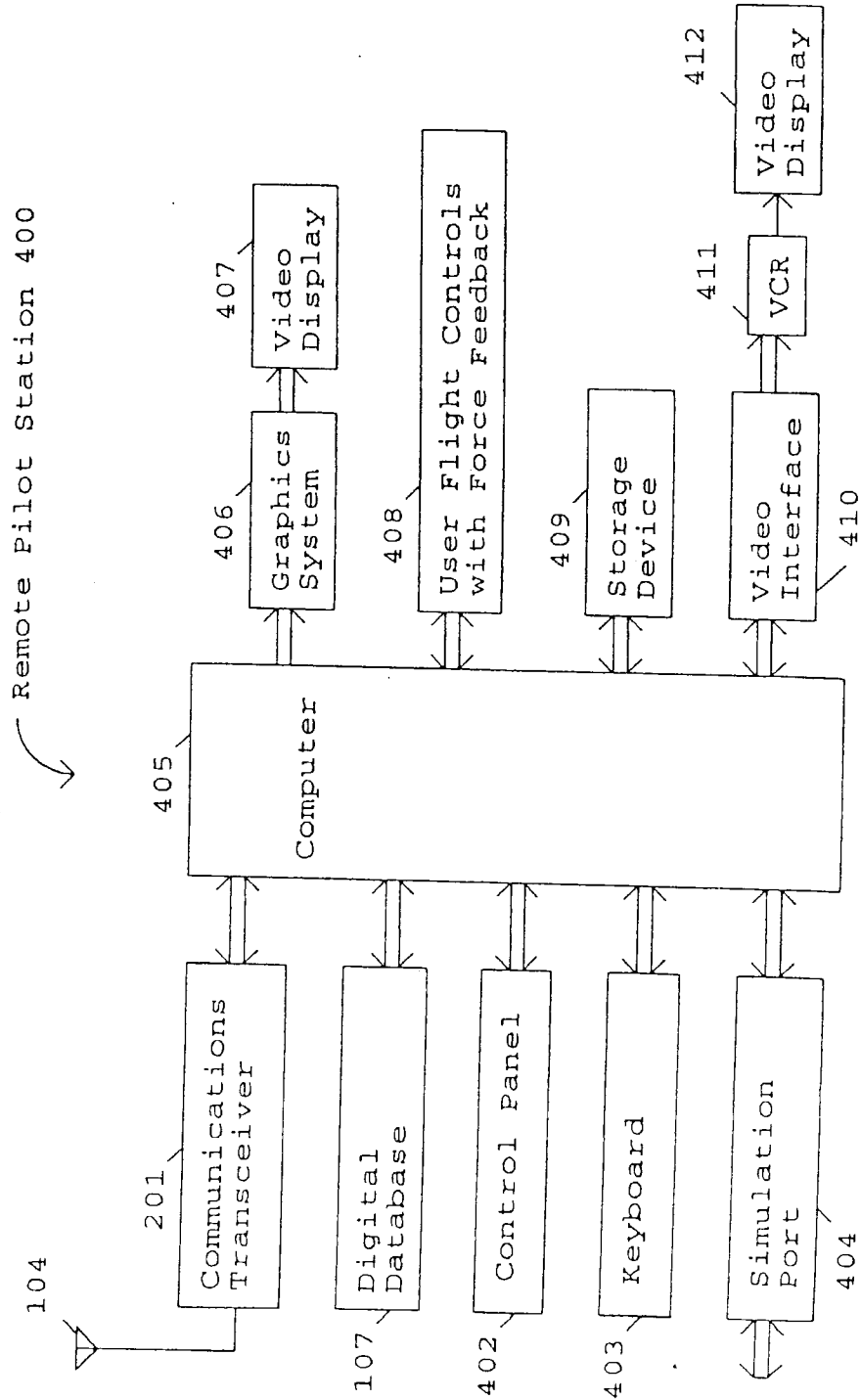

Fig. 4

01675

F

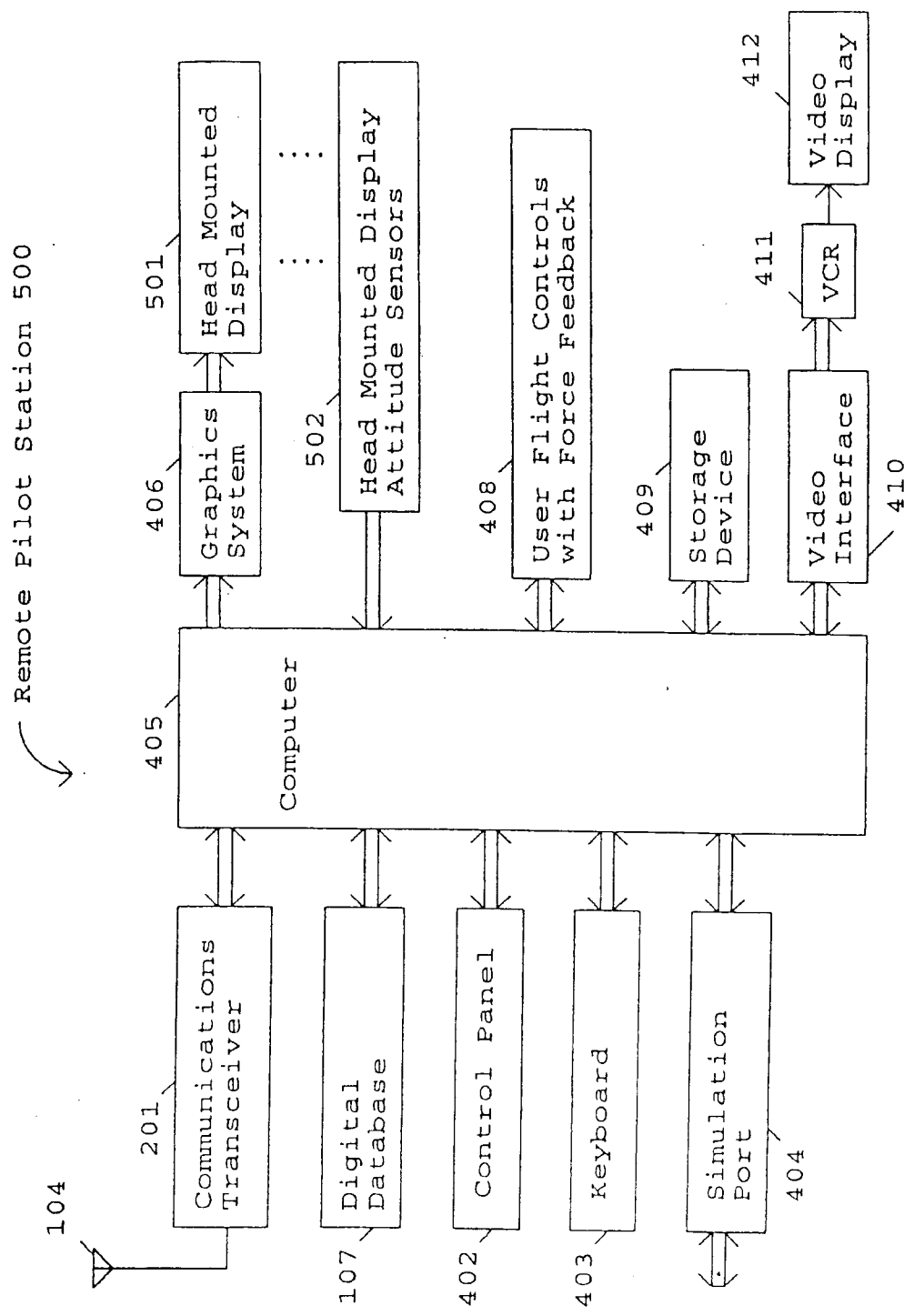

Fig. 5

APPROVED	O.G. FIG.	
BY	CLASS	SUBCLASS
DRAFTSMAN		

DR/587731

Remote Aircraft Simulator 600

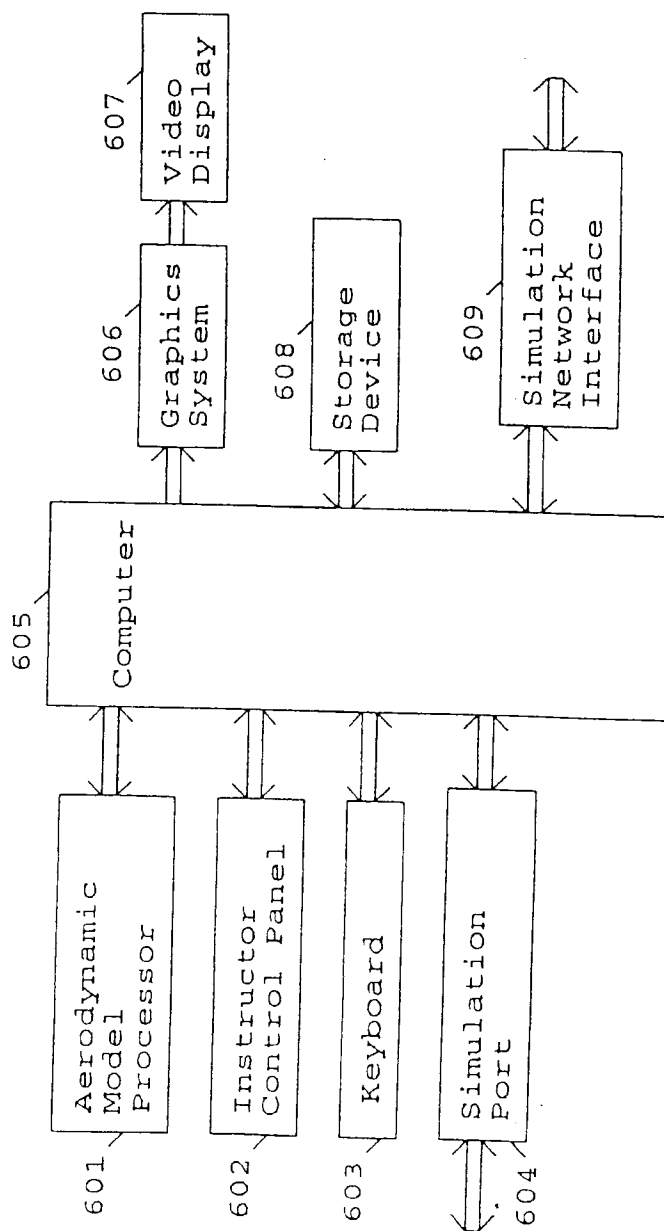

Fig. 6

01677

APPROVED	O.G. FIG.	
BY	CLASS	SUBCLASS
DRAFTSMAN		

02/587731

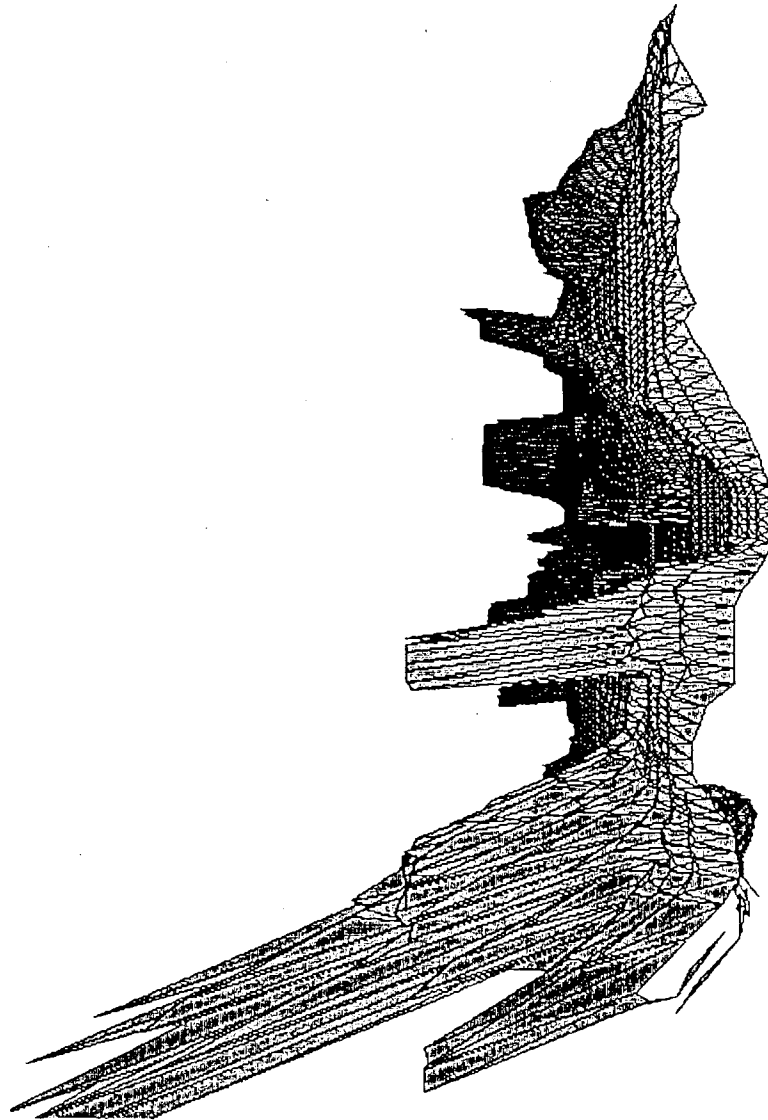

Figure 7

01673

PTO UTILITY GRANT

Paper Number 18

The
United
States
of
America



The Commissioner of Patents and Trademarks

Has received an application for a patent for a new and useful invention. The title and description of the invention are enclosed. The requirements of law have been complied with, and it has been determined that a patent on the invention shall be granted under the law.

Therefore, this

United States Patent

Grants to the person(s) having title to this patent the right to exclude others from making, using, offering for sale, or selling the invention throughout the United States of America or importing the invention into the United States of America for the term set forth below, subject to the payment of maintenance fees as provided by law.

If this application was filed prior to June 8, 1995, the term of this patent is the longer of seventeen years from the date of grant of this patent or twenty years from the earliest effective U.S. filing date of the application, subject to any statutory extension.

If this application was filed on or after June 8, 1995, the term of this patent is twenty years from the U.S. filing date, subject to a statutory extension. If the application contains a specific reference to an earlier filed application or applications under 35 U.S.C. 120, 121 or 365(c), the term of the patent is twenty years from the date on which the earliest application was filed, subject to any statutory extension.

Bence Lehman
Commissioner of Patents and Trademarks

Attest
Mary H. Green

Form PTD-1584 (Rev. 2/97)

01679