

04-22-05

2141  
ERW



1  
2  
3  
4  
5 **IN THE UNITED STATES PATENT AND TRADEMARK OFFICE**  
6

7  
8 In re Application of Jed Margolin

9 Serial No.: 09/947,801

Examiner: Chirag R. Patel

10 Filed: 09/06/2001

Art Unit: 2141

11 For: DISTRIBUTED COMPUTING SYSTEM  
12

13 Mail Stop Amendment  
14 Commissioner for Patents  
15 P.O. Box 1450  
16 Alexandria, VA 22313-1450  
17

18 **RESPONSE**  
19

20 Dear Sir:  
21

22 In response to the Office Action mailed January 26, 2005, please consider the  
23 following remarks.  
24

25 **Section 1. General Summary**

26 Claims 1 - 5 were rejected solely under 35 U.S.C. §102(e) as being anticipated by Ellis  
27 (US 6,167,428). Applicant will show that the elements "server" and "network server" used  
28 by Ellis are distinctly different from the term "home network server" used by Applicant and  
29 this difference makes Applicant's invention distinctly different from Ellis's. Applicant will  
30 show:

- 31 1. The definition of *Server* as would have been commonly understood at the time  
32 Ellis's invention was made.  
33 2. Ellis uses the terms *Server* and *Network Server* to mean the same thing.

- 1 3. Ellis makes a clear distinction between the *PC User* and the *Network Provider* (also  
2 called *Internet Service Provider*).
- 3 4. Ellis's financial arrangement requires that the *PC User* and the *Network Provider* be  
4 different entities.
- 5 5. Ellis's *Server* is part of the *Network Provider*, not the *PC User*.
- 6 6. Ellis has drawn a distinction between the *Network Provider* and the *Internet*. The  
7 Applicant has not drawn such a distinction.
- 8 7. Applicant acted as his own lexicographer to define *Home Network Server*.
- 9 8. Applicant's *Home Network Server* is distinctly different from Ellis's *Server (Network*  
10 *Server)*.
- 11 9. Ellis's preference for a network architecture that physically clusters PCs together  
12 teaches away from Applicant's invention which teaches the value of having Home  
13 Network Servers located in widely different geographic areas in order to distribute  
14 the load on electric utility companies.
- 15
- 16

1 **Section 2 - Detailed Response**

2  
3 ***Claims 1-5 are rejected under 35 U.S.C. 102(e) as being anticipated by Ellis***  
4 ***(US 6,167,428).***

5  
6 ***As per claims 1 and 3, Ellis discloses a distributed computing system***  
7 ***comprising:***  
8

---

9  
10 ***(a) a home network server in a subscriber's home; (Col 7 lines 66-67, Col 8***  
11 ***lines 1-14 and 23-28)***

12  
13 **Summary of Applicant's Response:**

- 14
- 15 • The server taught by Ellis is part of the Network Provider's equipment.
  - 16 • Ellis draws a sharp dividing line between network providers such as internet service  
17 providers (ISPs) and PC users.
  - 18 • Ellis's financial arrangement requires that the PC User and the Network Provider be  
19 different entities.
  - 20 • Ellis's network server's computing resources are not the resources being traded by  
21 the PC User for something of value such as Internet access. Instead, it is the  
22 resources of PC User which are being traded.
  - 23 • Applicant's Home Network Server is part of the subscriber's system and is located  
24 on the Subscriber's premises. It is the resources of the Home Network Server that  
25 are being traded for something of value, like subsidized or free Internet access.

26 **Response - Part 1. The definition of Server as would have been commonly**  
27 **understood at the time Ellis's invention was made.**

28  
29 Since Ellis has not served as his own lexicographer, the term must be defined as it was  
30 commonly used at the time Ellis's invention was made.

31  
32 A good, commonly used, current definition of server can be found at Wikipedia  
33 (<http://en.wikipedia.org/wiki/Server>):  
34

1 In computing, a **server** is:

- 2 • A computer software application that carries out some task on behalf of users. This is  
3 usually divided into file serving, allowing users to store and access files on a common  
4 computer; and application serving, where the software runs a computer program to carry out  
5 some task for the users. This is the original meaning of the term. Web, mail, and database  
6 servers are what most people access when using the internet.  
7
- 8 • The term is now also used to mean the physical computer on which the software runs.  
9 Originally server software would be located on a mainframe computer or  
10 minicomputer. These have largely been replaced by computers built using a more  
11 robust version of the microprocessor technology than is used in personal computers,  
12 and the term "server" was adopted to describe microprocessor-based machines  
13 designed for this purpose. In a general sense, server machines have high-capacity (and  
14 sometimes redundant) power supplies, a motherboard built for durability in 24x7  
15 operations, large quantities of ECC RAM, and fast I/O subsystem employing  
16 technologies such as SCSI, RAID, and PCI-X or PCI-Express.  
17 .  
18 .  
19 .

20 **Usage**

21 Sometimes this dual usage can lead to confusion, for example in the case of a web  
22 server. This term could refer to the machine which stores and operates the websites, and  
23 it is used in this sense by companies offering commercial hosting facilities.  
24 Alternatively, *web server* could refer to the software, such as the Apache HTTP server,  
25 which runs on such a machine and manages the delivery of web page components in  
26 response to requests from web browser clients.  
27

28 Although Ellis traces its parentage to at least U.S. Application No. 08/980,058 filed Nov.  
29 26, 1997, and possibly even further to provisional application 60/031855, filed Nov. 29,  
30 1996, Applicant believes the Wikipedia definition correctly represents the term as it would  
31 have been commonly understood at that time. The full Wikipedia entry for *Server* is  
32 reproduced in Appendix A.  
33

34  
35  
36  
37 **Response - Part 2. Ellis uses the terms *Server***  
38 **and *Network Server* to mean the same thing.**

39  
40  
41  
42  
43 In Column 12 lines 26-33, Ellis refers to Reference  
44 Number 2 as *server 2*.  
45

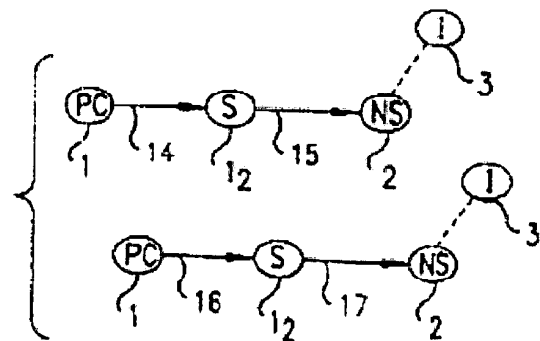

46  
47  
48  
49  
FIG.5

1 Such shared processing can continue until the device 12 detects the an application being  
 2 opened 16 in the first PC (or at first use of keyboard, for quicker response, in a  
 3 multitasking environment), when the device 12 would signal 17 the network computer  
 4 such as a *server 2* that the PC is no longer available to the network, as shown in FIG.  
 5 5B, so the network would then terminate its use of the first PC.  
 6

8 In Column 17 lines 32-41, Ellis refers to Reference Number 2 as *network 2*.

10 Preferably, wireless connections 100 would be extensively used in  
 12 home or business network systems, including use of a master remote  
 14 controller 31 without (or with) microprocessing capability, with  
 16 preferably broad bandwidth connections such as fiber optic cable  
 18 connecting directly to at least one component such as a PC 1, shown  
 20 in a slave configuration, of the home or business personal network  
 22 system; that preferred connection would link the home system to the  
 24 *network 2* such as the Internet 3, as shown in FIG. 10I.  
 26  
 28

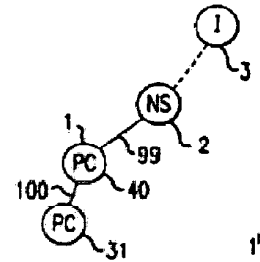

FIG. 10I

30 Moreover, in the Abstract, Ellis refers to *network servers (2)* in a list of items that are  
 31 clearly being referred to by the reference numbers used in the drawings.  
 32

### Abstract

33 This invention relates to computer networks having computers like personal computers  
 34 (1) or *network servers (2)* with microprocessors linked (5) by transmission means (4,  
 35 14) and having hardware, and other means such that at least one parallel processing  
 36 operation occurs that involve at least two computers in the network. This invention also  
 37 relates to large networks composed of smaller networks, like the Internet (3), wherein  
 38 more than one separate parallel processing operation involving more than one set of  
 39 computers occurs simultaneously and wherein ongoing processing linkages can be  
 40 established between microprocessors of separate computers connected to the network.  
 41 This invention further relates to business arrangements enabling the shared used of  
 42 network microprocessors for parallel and other processing wherein personal computer  
 43 owners provide microprocessor processing power to a network, in exchange for linkage  
 44 to other computers including linkage to other microprocessors; the basis of the  
 45 exchange between owners and providers being whatever terms to which the parties  
 46 agree.  
 47  
 48  
 49  
 50  
 51  
 52

53 Indeed, Ellis's choice of labels used in the drawings showing Reference Number 2 is  
 54 **NS**, which would be an entirely reasonable abbreviation for **Network Server**.  
 55  
 56

1 **Response - Part 3. Ellis makes a clear distinction between the PC User and the**  
2 **Network Provider (also called Internet Service Provider).**

3  
4 Ellis draws a sharp dividing line between network providers such as internet service  
5 providers (ISPs) and PC users. From Column 7 lines 37-47:

6  
7 Unlike existing one way functional relationships between *network providers such as*  
8 *internet service providers* (often currently utilizing telecommunications networks for  
9 connectivity) and *PC users*, wherein the *network provider* provides access to a network  
10 like the Internet for a fee (much like cable TV services), this new relationship would  
11 recognize that the *PC user* is also providing the *network* access to the *user's PC* for  
12 parallel computing use, which has a similar value. The PC thus both provides and uses  
13 services on the network, alternatively or potentially even virtually simultaneously, in a  
14 multitasking mode.

15  
16  
17 Column 7 Line 66 – Column 8 line 28:

18 For this new network and its structural relationships, *a network provider* is defined in  
19 the broadest possible way as any entity (corporation or other business, government, not-  
20 for-profit, cooperative, consortium, committee, association, community, or other  
21 organization or individual) that provides personal computer users (very broadly defined  
22 below) with initial and continuing connection hardware and/or software and/or  
23 firmware and/or other components and/or services to any network, such as the Internet  
24 and Internet II or WWW or their present or future equivalents, coexistors or successors,  
25 like the MetaInternet, *including any of the current types of Internet access providers*  
26 *(ISP's)* including telecommunication companies, television cable or broadcast  
27 companies, electrical power companies, satellite communications companies, or their  
28 present or future equivalents, coexistors or successors. The connection means used in  
29 the networks of the network providers, including between personal computers or  
30 equivalents or successors, would preferably be very broad bandwidth, by such means as  
31 fiber optic cable or wireless for example, but not excluding any other means, including  
32 television coaxial cable and telephone twisted pair, as well as associated gateways,  
33 bridges, routers, and switches with all associated hardware and/or software and/or  
34 firmware and/or other components and their present or future equivalents or successors.  
35 *The computers used by the providers include any computers, including* mainframes,  
36 minicomputers, *servers*, and personal computers, and associated their associated  
37 hardware and/or software and/or firmware and/or other components, and their present or  
38 future equivalents or successors.  
39  
40

2 Column 12 lines 34-46:

4 In a preferred embodiment, as shown in FIG. 6, there  
6 would be a (hardware and/or software and/or  
8 firmware and/or other component) signaling device 18  
10 for the *PC 1* to indicate or signal 15 to the network the  
12 *user PC's* availability 14 for network use (and  
14 whether full use or multitasking only) as well as its  
16 specific hardware/software/firmware/other  
18 components) configuration 20 (from a status 19  
20 provided by the PC) in sufficient detail for the

21 *network or network computer such as a server 2* to utilize its capability effectively. In  
22 one embodiment, the transponder device would be resident in the user PC and broadcast  
23 its idle state or other status (upon change or periodically, for example) or respond to a  
24 query signal from a network device.  
25

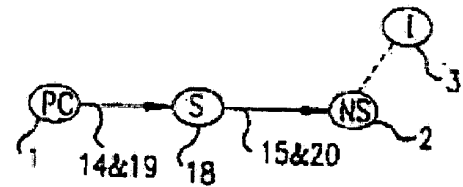

FIG. 6

26 Ellis's financial arrangement is between the PC User and the Network Provider.

27 Column 10 lines 1-6:

28 The *financial basis* of the shared use *between owners/lesers and providers* would be  
29 whatever terms to which the *parties* agree, subject to governing laws, regulations, or  
30 rules, including payment from *either party* to the other based on periodic measurement  
31 of net use or provision of processing power.  
32

33 If the PC User and the Network Provider were the same entity, Ellis's financial  
34 arrangement would be only with himself. As a result, Ellis's invention would not be  
35 useful, thereby failing to meet the requirements of 35 U.S.C. 101, rendering the Ellis  
36 patent invalid.

### 37 35 U.S.C. 101 Inventions patentable.

38 Whoever invents or discovers any new and *useful* process, machine, manufacture, or  
39 composition of matter, or any new and useful improvement thereof, may obtain a patent  
40 therefor, subject to the conditions and requirements of this title.

41 However, since issued U.S. patents are presumed valid under 35 U.S.C. 282, Ellis's  
42 PC User and Network Provider must be understood as being separate entities.

### 43 35 U.S.C. 282 Presumption of validity; defenses. - Patent Laws (First Paragraph):

44 A patent shall be presumed valid. Each claim of a patent (whether in independent,  
45 dependent, or multiple dependent form) shall be presumed valid independently of the  
46 validity of other claims; dependent or multiple dependent claims shall be presumed valid  
47 even though dependent upon an invalid claim. Notwithstanding the preceding sentence, if a  
48 claim to a composition of matter is held invalid and that claim was the basis of a  
49 determination of nonobviousness under section 103(b)(1), the process shall no longer be

1 considered nonobvious solely on the basis of section 103(b)(1). The burden of establishing  
 2 invalidity of a patent or any claim thereof shall rest on the party asserting such invalidity.  
 3

4  
 5 **Response - Part 4. Ellis's Server 2 is part of the Network Provider, not the PC User.**

6 The Servers (also referred to in Ellis as Network Servers) are on the ISP side of the line.

7 Column 6 lines 5-9:

8  
 9 FIG. 1 is a simplified diagram of a section of a computer network, such as the Internet,  
 10 showing an embodiment of a meter means which measures flow of computing during a  
 11 shared operation such as parallel processing *between a typical PC user and a network*  
 12 *provider*.  
 13

14 Column 10 lines 7-14:

15  
 16 In one embodiment, as shown in FIG. 1, in order for this network structure to function  
 17 effectively, there would be a meter device 5 (comprised of hardware and/or software  
 18 and/or firmware and/or other component) to measure the flow of computing power  
 19 *between PC 1 user and network 2 provider*, which might provide connection to the  
 20 Internet and/or World Wide Web and/or Internet II and/or any present or future  
 21 equivalent or successor 3, like the MetaInternet.  
 22

23 In the second reproduction of Ellis Figure 1 (below) a line has been added to  
 24 emphasize Ellis's division between Meter 5 and Network Server 2. Network Server 2  
 25 is not in the subscriber's home.

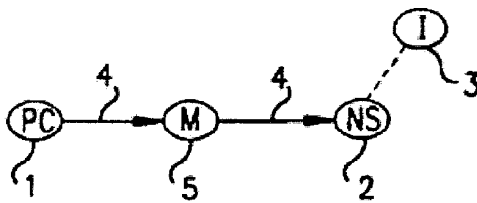

FIG. 1

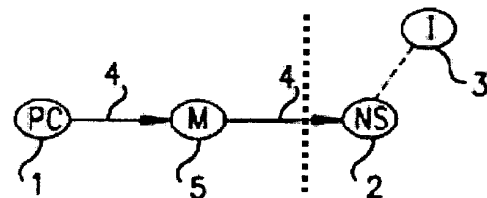

FIG. 1



1 **Response - Part 5. Ellis has drawn a distinction between the Network Provider and**  
 2 **the Internet. The Applicant has not drawn such a distinction.**

8 Ellis Figure 1 shows Network Provider 2 as  
 10 separate from Internet 3.

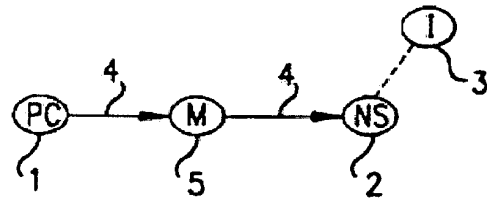

FIG. 1

16 In Applicant's Figure 1, Modem 103 is shown as connecting to the Internet. There is no  
 17 distinction made between the Internet Service Provider and the Internet. Applicant states,  
 18 in Paragraph 0002 of the present Application:

19 [0002] This invention relates to a distributed computing system. For the purposes of  
 20 this application the term "distributed computing" includes "distributed storage." **The**  
 21 **term "Internet" refers to the current world wide packet data communication**  
 22 **network and whatever system may replace it regardless of what name it may be**  
 23 **given or what communications protocol it may use. It also includes on-line services**  
 24 **which, although they may not consider themselves the "Internet", provide a**  
 25 **gateway for their subscribers to the Internet.**

27 Most people consider their Internet connection to start at the point where they connect to  
 28 their Internet Service Provider, which is probably why it's called an ***Internet Service***  
 29 ***Provider***. Applicant has followed this convention, Ellis has not.

32 **Response - Part 6. Applicant acted as his own lexicographer to define Home**  
 33 **Network Server.**

35 From the application of the present Applicant:

36 **SUMMARY OF THE INVENTION**

37 [0014] A Home Network Server is used in a home to network various clients such as  
 38 PCs, sensors, actuators, and other devices. It also provides the Internet connection to the  
 39 various client devices in the Home Network. The Home Network Server also provides a  
 40 firewall to prevent unauthorized access to the Home Network from the Internet. The use  
 41 of a Home Network Server, as opposed to the use of peer-to-peer networking, allows a

1 robust operating system to be used. It also allows the users on the Home Network to add  
2 additional applications to their PCs without fear of jeopardizing the proper functioning  
3 of their Internet security program (firewall) or the distributed computing software.  
4 (Although a firewall is not strictly necessary, prudence dictates its use.)  
5

6 **Response - Part 7. Applicant's Home Network Server is distinctly different from**  
7 **Ellis's Server (Network Server).**

8  
9 As has been shown, Ellis's **server 2** is part of his Network Provider's equipment. As such,  
10 its computing resources are not the resources being traded by the PC User for something  
11 of value such as Internet access. Instead, it is the resources of **PC 1** which are being  
12 traded.  
13

14 In the Applicant's invention, **Home Network Server 101** is part of the subscriber's system  
15 and is located on the Subscriber's premises. It is the resources of **Home Network Server**  
16 **101** that are being traded for something of value, like subsidized or free Internet access.  
17

18 **Home Network Server 101** has a number of other, important functions, in addition to  
19 acting as a proxy server for the Subscriber's Internet access. It provides the computing  
20 resources to operate the systems in the Subscriber's home. See Applicant's Application  
21 Paragraph 0026:

22 [0026] Router, Switch, or Hub 102 connects to one or more clients such as PC<sub>1</sub> 104  
23 or Sensor/Actuator<sub>1</sub> 106. More than one client PC may be used, such as PC<sub>n</sub> 105,  
24 and more than one Sensor/Actuator may be used, such as Sensor/Actuator<sub>n</sub> 107.  
25 ***Sensor/Actuators are used to control and/or monitor the home's systems such as***  
26 ***HVAC and Security and appliances such as refrigerators, washers, and dryers.***  
27

28 Another of the advantages of Applicant's **Home Network Server 101** is that it can run a  
29 robust, stable operating system without requiring the Subscriber to replace his software.  
30 At the time Ellis's invention was made, as well as the time the invention of the present  
31 Applicant was made, the vast majority of PCs used some version of the Microsoft Windows  
32 Operating System, and most PC Applications were available only for such systems. Thus,  
33 one advantage of Applicant's uses of **Home Network Server 101** is that the Subscriber  
34 can continue to use Microsoft Windows on his PCs without jeopardizing the safety of his  
35 home's systems.

1 In Ellis's response to the First Office Action for his application 09/320,660 he made clear  
2 the importance of being able to run applications on his *PC 1* which were not available to  
3 the operating systems typically used by servers. (The First Office Action was mailed  
4 October 14, 1999, Ellis's Response is dated April 14, 2000, and the application was  
5 eventually issued as U.S. Patent 6,167,428 .)

6  
7 From Ellis's Response, Page 24 Second Paragraph:  
8

9       The Examiner appears to have rejected claims 27-41 because of a belief that UNIX  
10 and NT servers can be run on personal computers and can be made to function  
11 temporarily as a master personal computer or as a slave personal computer, as similarly  
12 recited in claims 27-41. However, a UNIX or an NT server functions as a server, not as  
13 a master personal computer or as a slave personal computer, which require applications  
14 not found in UNIX or NT operating systems. Therefore, Applicant submits that neither  
15 Seti@home nor a UNIX or an NT server running on personal computers discloses,  
16 teaches or suggests: .....

17  
18 Ellis then discusses how this relates to his claims. However, the importance of being able  
19 to run standard PC applications on Ellis's *PC 1* has been established.

20  
21 In contrast, the value of Applicant's *Home Network Server 101* is precisely its ability to  
22 use a stable, reliable Operating System. As was previously noted, at the time Ellis's  
23 invention was made, as well as the time the invention of the present Applicant was made,  
24 the vast majority of PCs used some version of the Microsoft Windows Operating System,  
25 and most PC Applications were available only for such systems. Hence the value of having  
26 *Home Network Server 101* being able to run a stable, reliable Operating System.

27  
28 Thus, Ellis's clarification of his invention made in his Response teaches away from the  
29 invention of the present Applicant and further shows how Applicant's *Home Network*  
30 *Server 101* is distinctly different from Ellis's *Server (Network Server) 2* as well as Ellis's  
31 *PC 1* personal computer.  
32

(b) one or more home network client devices; (Col 13 lines 8-29, Figure 9)

The PCs shown in Ellis Figure 9 are not home network client devices. They are networked PCs participating in parallel processing. According to Ellis Column 6 lines 49-53:

FIG. 9 is a simplified diagram of a section of a computer network, such as the Internet, showing an embodiment of a system architecture for conducting a request initiated by a PC for a search using parallel processing means that utilizes a number of networked PC's.

(Presumably, Ellis meant "a request *initiated* by a PC" and not "a request *imitated* by a PC.")

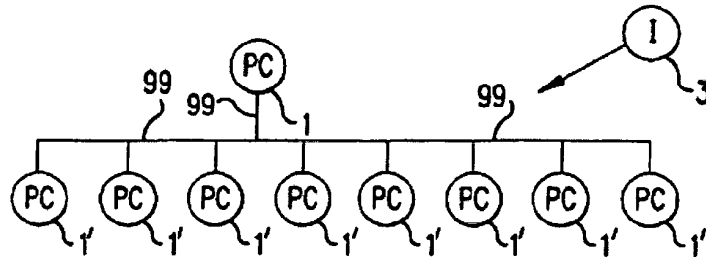

FIG. 9

Applicant's invention does not use the resources of the Home Network clients for its distributed computing agreement. It uses the unused resources of *Home Network Server 101*.

(c) an Internet connection; (Col 8 lines 7-10, Col 13 lines 4-7, Figure 1 item 3)

Ellis Figure 1  
Item 3

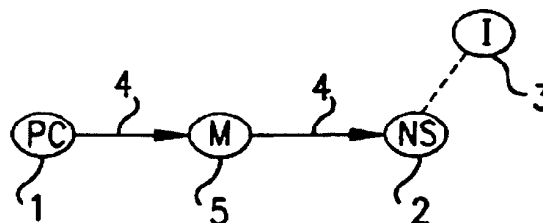

FIG. 1

1  
2  
3 Both Ellis and present Applicant use the Internet. However, as detailed in Response - Part  
4 5, Ellis's **Network Server 2** is part of the Network Provider, not Subscriber's **PC 1**. In  
5 addition, most people consider their Internet connection to start at the point where they  
6 connect to their Internet Service Provider, which is probably why it's called an **Internet**  
7 **Service Provider**. Applicant has followed this convention, Ellis has not.

---

8  
9  
10 ***whereby the subscriber receives something of value in return for access to***  
11 ***the resources of said home network server that would otherwise be unused. (Col 7***  
12 ***lines 38-48, Col 10 lines 1-6)***  
13  
14

15 Both Ellis and present Applicant receive something of value for the use of otherwise-  
16 unused computing resources. However, Ellis's computing resources are provided by the  
17 Subscriber's **PC 1** while present Applicant provides the otherwise-unused computing  
18 resources of Subscriber's Home **Network Server 101**, which Ellis lacks. The advantage of  
19 Applicant's system has been discussed in Response - Part 7 above.

---

20  
21  
22 To summarize Applicant's response to Examiner's rejection of Claims 1 and 3:

- 23  
24 **1.** Ellis does not show a Home Network Server. Ellis's **server 2** is part of the Internet  
25 Service Provider's equipment and is not in the Subscriber's home.
- 26 **2.** As such, its computing resources are not the resources being traded by the PC User for  
27 something of value such as Internet access. Instead, it is the resources of **PC 1** which are  
28 being traded.
- 29 **3.** Ellis's financial arrangement requires that the PC User and the Network Provider be  
30 different entities.
- 31 **4.** The PCs shown in Ellis Figure 9 are not home network client devices. They are  
32 networked PCs participating in parallel processing. Applicant's invention does not use the  
33 resources of the Home Network clients for its distributed computing agreement. It uses the  
34 resources of **Home Network Server 101**.

1  
2       **As per claims 2 and 4, Ellis discloses a distributed computing system further**  
3 **comprising:**

4  
5       **(a) a first firewall between said Internet connection and said home network**  
6 **server; Ellis teaches the concept of supporting the structure of inserting a firewall**  
7 **between the internet and home network server to provide security for the host PC**  
8 **against instruction by outside hackers. (Col 19 lines 25-32)**  
9

10       **(b) a second firewall to prevent unwanted interactions between said access to**  
11 **the resources of said home network server that would otherwise be unused and**  
12 **said home network server. (Col 16 lines 33-42, Col 19 lines 19-25)**  
13

14 While both Ellis and Applicant recognize the value of firewalls, Ellis does not use a home  
15 network server. Column 19 lines 25-32, Column 16 lines 33-42, and Column 19 lines 25-32  
16 refer to Ellis Figure 10A – Figure 10I, all of which show **Server 2** and **Internet 3**, which as  
17 has been previously discussed, is part of the Network Provider, not Subscriber's **PC 1**.

18  
19 Furthermore, Claim 2 is dependent on Claim 1 and Claim 4 is dependent on Claim 3.

20 Applicant believes Examiner's rejection of Claim 1 and Claim 3 has been traversed, so that  
21 Examiner's rejection of Claim 2 and Claim 4 has likewise been traversed.

22

1 Applicant wishes to note the following:  
2

3 **Part 8. Ellis's preference for a network architecture that physically clusters PCs**  
4 **together teaches away from Applicant's invention which teaches the value of having**  
5 **Home Network Servers located in widely different geographic areas in order to**  
6 **distribute the load on electric utility companies.**

7  
8 Column 20 line 50 to Column 21 line 18:

9 The individual user PC's can be connected to the Internet (via an Intranet)/Internet  
10 II/WWW or successor, like the MetaInternet (or other) network by any electromagnetic  
11 means, with the speed of fiber optic cable being preferred, but hybrid systems using  
12 fiber optic cable for trunk lines and coaxial cable to individual users may be more cost  
13 effective initially, but much less preferred unless cable can be made (through hardware  
14 and/or software and/or firmware and/or other component means) to provide sufficiently  
15 broad bandwidth connections to provide unrestricted throughput by connected  
16 microprocessors. Given the speed and bandwidth of transmission of fiber optic or  
17 equivalent connections, conventional network architecture and structures should be  
18 acceptable for good system performance, making possible a virtual complete  
19 interconnection network between users.  
20

21 ***However, the best speed for any parallel processing operation should be obtained, all***  
22 ***other things being equal, by utilizing the available microprocessors that are physically***  
23 ***the closest together.*** Consequently, as shown previously in FIG. 8, the network needs  
24 have the means (through hardware and/or software and/or firmware and/or other  
25 component) to provide on a continually ongoing basis the capability for each PC to  
26 know the addresses of the nearest available PC's, perhaps sequentially, from closest to  
27 farthest, for the area or cell immediately proximate to that PC and then those cells of  
28 adjacent areas.  
29

30 ***Network architecture that clusters PC's together should therefore be preferred and***  
31 ***can be constructed by wired means.*** However, as shown in FIG. 11, it would probably  
32 be optimal to construct local network clusters 101 (or cells) of personal computers 1' by  
33 wireless 100 means, since physical proximity of any PC 1 to its closest other PC 1'  
34 should be easier to access directly that way, as discussed further below. Besides, it is  
35 economically preferable for at least several network providers to serve any given  
36 geographic area to provide competitive service and prices.  
37  
38

39 Column 22 lines 38-51:

40 ***The FIG. 14 approach to establishing local PC clusters 101 for parallel or other***  
41 ***shared processing has major advantage in that it avoids using network computers***  
42 ***such as servers*** (and, if wireless, other network components including even connection  
43 means), ***so that the entire local system of PC's within a cluster 101 would operate***  
44 ***independently of network servers, routers, etc.*** Moreover, particularly if connected by  
45 wireless means, ***the size of the cluster 101 could be quite large***, being limited generally

1 by PC transmission power, PC reception sensitivity, and local conditions. Additionally,  
2 one cluster 101 could communicate by wireless 100 means with an adjacent or other  
3 clusters 101, as shown in FIG. 14B, which could include those beyond its direct  
4 transmission range.  
5

6 According to the article listed by Applicant on the Information Disclosure Statement filed  
7 with the Application, entitled "**Internet data gain is a major power drain on local**  
8 **utilities**", Tuesday, September 5, 2000 By John Cook. Seattle Post-Intelligencer  
9 Reporter, the demand for electric power by large server farms was already beginning to be  
10 a problem for electric utilities.  
11

12 Power-hungry server farms were mentioned in the article *U.S. Power Grid Faces Grim*  
13 *Summer* by James Jelter, Reuters, March 30, 2001 (The complete article can be found at  
14 <http://www.bluefish.org/facegrim.htm> and is reproduced in **Appendix B.**)

15 In California, severe energy shortages have dragged the state's 34 million residents  
16 through four days of rolling blackouts so far this year, and state officials warn there are  
17 more to come. ....

18 But that growth rate is much higher in the West, South and parts of the Northeast, the  
19 regions experiencing the fastest population growth and hosting the strongest local  
20 economies.

21 Supporting those economies are a fleet of corporate and home computers and "server  
22 farms" — vast warehouses crammed with the computers that run the Internet.

23 The biggest of these farms use a whopping 120 megawatts around the clock, equal to  
24 the energy use of 120,000 homes and enough to merit a new mid-sized plant to serve  
25 each facility.

26 As noted by Applicant in Paragraph 17 in the present Application:  
27

28 **[0017]** Since Home Network Servers may be located in widely different geographic  
29 areas, the use of Home Network Servers for distributed computing also distributes the  
30 load on electric utility companies.  
31

32 Thus, Ellis's preference for a network architecture that physically clusters PCs together  
33 teaches away from Applicant's invention which teaches the value of having Home Network  
34 Servers located in widely different geographic areas in order to distribute the load on  
35 electric utility companies.



1 Furthermore, Ellis emphasizes the use of his distributed processing system for  
2 performing parallel processing, especially for computational tasks and for performing  
3 searches.

4  
5 Column 9 lines 22-25:

6 Parallel processing is defined as one form of shared processing as involving two or more  
7 microprocessors involved in solving the same computational problem or other task.  
8

9 Column 13 lines 4-10

10 One of the primary capabilities of the Internet (or Internet II or successor, like the  
11 MetaInternet) or WWW network computer would be to facilitate searches by the PC user  
12 or other user. As shown in FIG. 9, searches are particularly suitable to multiple processing,  
13 since, for example, a typical search would be to find a specific Internet or WWW site with  
14 specific information.  
15

16 In paragraph 0002 of the present Application, Applicant includes distributed storage as  
17 a function of distributed computing.

18 [0002] This invention relates to a distributed computing system. For the purposes of this  
19 application the term "distributed computing" includes "distributed storage."  
20

21 In paragraph 0018 of the present Application, Applicant further includes the use of  
22 distributed computing as a distributed server system, making large server farms  
23 unnecessary.  
24

25 [0018] In addition, as CPUs become faster and storage devices such as hard drives and  
26 optical storage devices become larger, and fast Internet connections become more  
27 widespread, the distributed computing system can also be used as a distributed server  
28 system, making large server farms (with their attendant demands on electric utilities)  
29 unnecessary.  
30

31  
32 Both of these applications, taught by Applicant and not by Ellis, reduce the demands  
33 on electric utilities made by larger server farms and further distinguish Applicant's  
34 invention from Ellis's, and show that Ellis teaches away from Applicant's invention.  
35  
36  
37

1

2

---

***As per claim 5, Ellis discloses A method for providing a distributed computing system comprising the steps of:***

5

6

***(a) providing a home network server in a subscriber's home; (Col 7 lines 66-67, Col 8 lines 1-14 and 23-28)***

8

9

**Summary of Applicant's Response:**

10

- The server taught by Ellis is part of the Network Provider's equipment.
- Ellis draws a sharp dividing line between network providers such as internet service providers (ISPs) and PC users.
- Ellis's financial arrangement requires that the PC User and the Network Provider be different entities.
- Ellis's network server's computing resources are not the resources being traded by the PC User for something of value such as Internet access. Instead, it is the resources of PC User which are being traded.

11

12

13

14

15

16

17

18

19

20

21

22

Applicant's Home Network Server is part of the subscriber's system and is located on the Subscriber's premises. It is the resources of the Home Network Server that are being traded for something of value, like subsidized or free Internet access.

23

**Response - Part 1. The definition of Server as would have been commonly understood at the time Ellis's invention was made.**

24

25

26

27

Since Ellis has not served as his own lexicographer, the term must be defined as it was commonly used at the time Ellis's invention was made.

28

29

A good, commonly used, current definition of server can be found at Wikipedia

30

(<http://en.wikipedia.org/wiki/Server>):

31

In computing, a **server** is:

32

33

34

35

36

37

- A computer software application that carries out some task on behalf of users. This is usually divided into file serving, allowing users to store and access files on a common computer; and application serving, where the software runs a computer program to carry out some task for the users. This is the original meaning of the term. Web, mail, and database servers are what most people access when using the internet.

- 1 • The term is now also used to mean the physical computer on which the software runs.  
 2 Originally server software would be located on a mainframe computer or  
 3 minicomputer. These have largely been replaced by computers built using a more  
 4 robust version of the microprocessor technology than is used in personal computers,  
 5 and the term "server" was adopted to describe microprocessor-based machines  
 6 designed for this purpose. In a general sense, server machines have high-capacity (and  
 7 sometimes redundant) power supplies, a motherboard built for durability in 24x7  
 8 operations, large quantities of ECC RAM, and fast I/O subsystem employing  
 9 technologies such as SCSI, RAID, and PCI-X or PCI-Express.

10 .  
 11 .  
 12 .

13 **Usage**

14 Sometimes this dual usage can lead to confusion, for example in the case of a web  
 15 server. This term could refer to the machine which stores and operates the websites, and  
 16 it is used in this sense by companies offering commercial hosting facilities.  
 17 Alternatively, *web server* could refer to the software, such as the Apache HTTP server,  
 18 which runs on such a machine and manages the delivery of web page components in  
 19 response to requests from web browser clients.  
 20

21 Although Ellis traces its parentage to at least U.S. Application No. 08/980,058 filed Nov.  
 22 26, 1997, and possibly even further to provisional application 60/031855, filed Nov. 29,  
 23 1996, Applicant believes the Wikipedia definition correctly represents the term as it would  
 24 have been commonly understood at that time. The full Wikipedia entry for *Server* is  
 25 reproduced in Appendix A.

26

27 **Response - Part 2. Ellis uses the terms Server and Network Server to mean the same**  
 28 **thing.**

29

30 In Column 12 lines 26-33, Ellis refers to Reference Number 2 as **server 2**.

31

32

33

34

35

36

37

38

39

40

41

42

43

44

45

46

47

48

49

Such shared processing can continue until the device 12 detects the an application being opened 16 in the first PC (or at first use of keyboard, for quicker response, in a multitasking environment), when the device 12 would signal 17 the network computer such as a *server 2* that the PC is no longer available to the network, as shown in FIG. 5B, so the network would then terminate its use of the first PC.

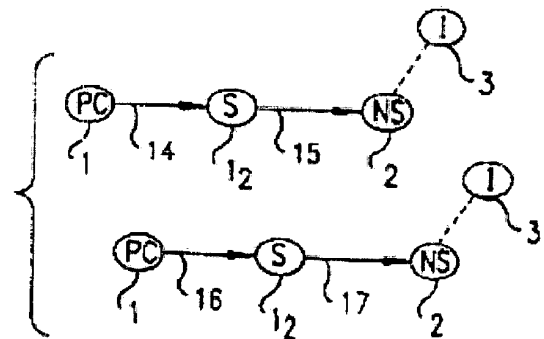

FIG.5

1

3 In Column 17 lines 32-41, Ellis refers to Reference Number 2 as **network 2**.

5

7 Preferably, wireless connections 100 would be extensively used in  
9 home or business network systems, including use of a master remote  
11 controller 31 without (or with) microprocessing capability, with  
13 preferably broad bandwidth connections such as fiber optic cable  
15 connecting directly to at least one component such as a PC 1, shown in  
17 a slave configuration, of the home or business personal network  
19 system; that preferred connection would link the home system to the  
21 **network 2** such as the Internet 3, as shown in FIG. 10I.

23

25

26 Moreover, in the Abstract, Ellis refers to **network servers (2)** in a list of items that are  
27 clearly being referred to by the reference numbers used in the drawings.

28

29

30

31

### Abstract

32

33

34

35

36

37

38

39

40

41

42

43

44

45

46

47

48

49

50

51

52

53

54

55

56

57

58

59

60

61

62

63

64

65

66

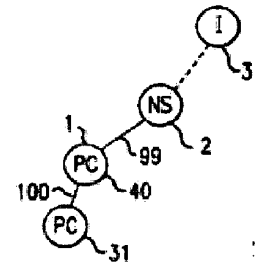

FIG. 10I

Indeed, Ellis's choice of labels used in the drawings showing Reference Number 2 is **NS**, which would be an entirely reasonable abbreviation for **Network Server**.

1 **Response - Part 3. Ellis makes a clear distinction between the PC User and the**  
2 **Network Provider (also called Internet Service Provider).**

3  
4 Ellis draws a sharp dividing line between network providers such as internet service  
5 providers (ISPs) and PC users. From Column 7 lines 37-47:

6  
7 Unlike existing one way functional relationships between *network providers such as*  
8 *internet service providers* (often currently utilizing telecommunications networks for  
9 connectivity) and *PC users*, wherein the *network provider* provides access to a network  
10 like the Internet for a fee (much like cable TV services), this new relationship would  
11 recognize that the *PC user* is also providing the *network* access to the *user's PC* for  
12 parallel computing use, which has a similar value. The PC thus both provides and uses  
13 services on the network, alternatively or potentially even virtually simultaneously, in a  
14 multitasking mode.

15  
16  
17 Column 7 Line 66 – Column 8 line 28:

18 For this new network and its structural relationships, *a network provider* is defined in  
19 the broadest possible way as any entity (corporation or other business, government, not-  
20 for-profit, cooperative, consortium, committee, association, community, or other  
21 organization or individual) that provides personal computer users (very broadly defined  
22 below) with initial and continuing connection hardware and/or software and/or  
23 firmware and/or other components and/or services to any network, such as the Internet  
24 and Internet II or WWW or their present or future equivalents, coexistors or successors,  
25 like the MetaInternet, *including any of the current types of Internet access providers*  
26 *(ISP's)* including telecommunication companies, television cable or broadcast  
27 companies, electrical power companies, satellite communications companies, or their  
28 present or future equivalents, coexistors or successors. The connection means used in  
29 the networks of the network providers, including between personal computers or  
30 equivalents or successors, would preferably be very broad bandwidth, by such means as  
31 fiber optic cable or wireless for example, but not excluding any other means, including  
32 television coaxial cable and telephone twisted pair, as well as associated gateways,  
33 bridges, routers, and switches with all associated hardware and/or software and/or  
34 firmware and/or other components and their present or future equivalents or successors.  
35 *The computers used by the providers include any computers, including* mainframes,  
36 minicomputers, *servers*, and personal computers, and associated their associated  
37 hardware and/or software and/or firmware and/or other components, and their present or  
38 future equivalents or successors.  
39

2 Column 12 lines 34-46:

4 In a preferred embodiment, as shown in FIG. 6, there  
 6 would be a (hardware and/or software and/or  
 8 firmware and/or other component) signaling device 18  
 10 for the *PC 1* to indicate or signal 15 to the network the  
 12 *user PC's* availability 14 for network use (and  
 14 whether full use or multitasking only) as well as its  
 16 specific hardware/software/firmware/other  
 18 components) configuration 20 (from a status 19  
 20 provided by the PC) in sufficient detail for the  
 21 *network or network computer such as a server 2* to utilize its capability effectively. In  
 22 one embodiment, the transponder device would be resident in the user PC and broadcast  
 23 its idle state or other status (upon change or periodically, for example) or respond to a  
 24 query signal from a network device.  
 25  
 26

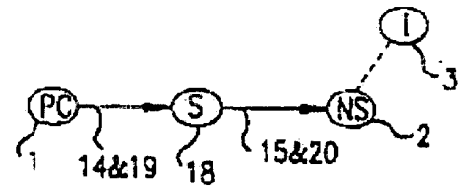

FIG. 6

27 Ellis's financial arrangement is between the PC User and the Network Provider.

28 Column 10 lines 1-6:

29 The *financial basis* of the shared use *between owners/lesers and providers* would be  
 30 whatever terms to which the *parties* agree, subject to governing laws, regulations, or  
 31 rules, including payment from *either party* to the other based on periodic measurement  
 32 of net use or provision of processing power.  
 33

34 If the PC User and the Network Provider were the same entity, Ellis's financial  
 35 arrangement would be only with himself. As a result, Ellis's invention would not be  
 36 useful, thereby failing to meet the requirements of 35 U.S.C. 101, rendering the Ellis  
 37 patent invalid.

38 **35 U.S.C. 101 Inventions patentable.**

39 Whoever invents or discovers any new and *useful* process, machine, manufacture, or  
 40 composition of matter, or any new and useful improvement thereof, may obtain a patent  
 41 therefor, subject to the conditions and requirements of this title.

42 However, since issued U.S. patents are presumed valid under 35 U.S.C. 282, Ellis's  
 43 PC User and Network Provider must be understood as being separate entities.

44 **35 U.S.C. 282 Presumption of validity; defenses. - Patent Laws (First Paragraph):**

45 A patent shall be presumed valid. Each claim of a patent (whether in independent,  
 46 dependent, or multiple dependent form) shall be presumed valid independently of the  
 47 validity of other claims; dependent or multiple dependent claims shall be presumed valid  
 48 even though dependent upon an invalid claim. Notwithstanding the preceding sentence, if a

1 claim to a composition of matter is held invalid and that claim was the basis of a  
 2 determination of nonobviousness under section 103(b)(1), the process shall no longer be  
 3 considered nonobvious solely on the basis of section 103(b)(1). The burden of establishing  
 4 invalidity of a patent or any claim thereof shall rest on the party asserting such invalidity.  
 5  
 6

7 **Response - Part 4. Ellis's Server 2 is part of the Network Provider, not the PC User.**

8 The Servers (also referred to in Ellis as Network Servers) are on the ISP side of the line.

9 Column 6 lines 5-9:

10  
 11 FIG. 1 is a simplified diagram of a section of a computer network, such as the Internet,  
 12 showing an embodiment of a meter means which measures flow of computing during a  
 13 shared operation such as parallel processing *between a typical PC user and a network*  
 14 *provider.*  
 15

16 Column 10 lines 7-14:

17  
 18 In one embodiment, as shown in FIG. 1, in order for this network structure to function  
 19 effectively, there would be a meter device 5 (comprised of hardware and/or software  
 20 and/or firmware and/or other component) to measure the flow of computing power  
 21 *between PC 1 user and network 2 provider*, which might provide connection to the  
 22 Internet and/or World Wide Web and/or Internet II and/or any present or future  
 23 equivalent or successor 3, like the MetaInternet.  
 24

25 In the second reproduction of Ellis Figure 1 (below) a line has been added to

26 emphasize Ellis's division between Meter 5 and Network Server 2. Network Server 2

27 is not in the subscriber's home.

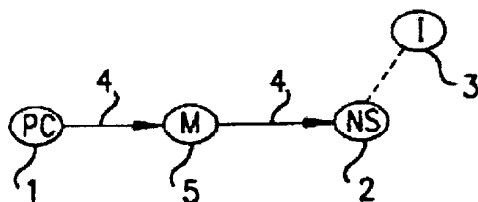

FIG. 1

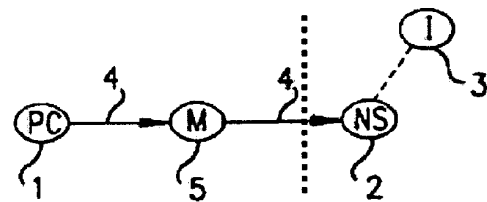
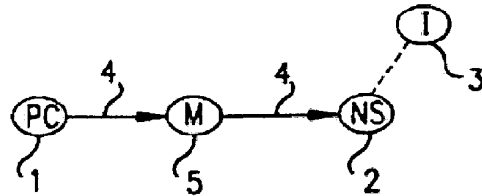

FIG. 1

1 **Response - Part 5. Ellis has drawn a distinction between the Network Provider and**  
 2 **the Internet. The Applicant has not drawn such a distinction.**

4  
6  
8 Ellis Figure 1 shows Network Provider 2 as  
10 separate from Internet 3.



12  
14  
15  
16  
17  
18  
19  
20  
21  
22  
23  
24  
25  
26  
27  
28  
29  
30  
31  
32  
33  
34  
35  
36  
37  
38  
39  
40  
41

FIG. 1

16 In Applicant's Figure 1, Modem 103 is shown as connecting to the Internet. There is no  
17 distinction made between the Internet Service Provider and the Internet. Applicant states,  
18 in Paragraph 0002 of the present Application:

19 [0002] This invention relates to a distributed computing system. For the purposes of  
20 this application the term "distributed computing" includes "distributed storage." **The**  
21 **term "Internet" refers to the current world wide packet data communication**  
22 **network and whatever system may replace it regardless of what name it may be**  
23 **given or what communications protocol it may use. It also includes on-line services**  
24 **which, although they may not consider themselves the "Internet", provide a**  
25 **gateway for their subscribers to the Internet.**

26  
27 Most people consider their Internet connection to start at the point where they connect to  
28 their Internet Service Provider, which is probably why it's called an *Internet Service*  
29 *Provider*. Applicant has followed this convention, Ellis has not.

30  
31  
32 **Response - Part 6. Applicant acted as his own lexicographer to define Home**  
33 **Network Server.**

34  
35 From the application of the present Applicant:

36 **SUMMARY OF THE INVENTION**

37 [0014] A Home Network Server is used in a home to network various clients such as  
38 PCs, sensors, actuators, and other devices. It also provides the Internet connection to the  
39 various client devices in the Home Network. The Home Network Server also provides a  
40 firewall to prevent unauthorized access to the Home Network from the Internet. The use  
41 of a Home Network Server, as opposed to the use of peer-to-peer networking, allows a



1 robust operating system to be used. It also allows the users on the Home Network to add  
2 additional applications to their PCs without fear of jeopardizing the proper functioning  
3 of their Internet security program (firewall) or the distributed computing software.  
4 (Although a firewall is not strictly necessary, prudence dictates its use.)  
5

6 **Response - Part 7. Applicant's Home Network Server is distinctly different from**  
7 **Ellis's Server (Network Server).**

8  
9 As has been shown, Ellis's **server 2** is part of his Network Provider's equipment. As such,  
10 its computing resources are not the resources being traded by the PC User for something  
11 of value such as Internet access. Instead, it is the resources of **PC 1** which are being  
12 traded.  
13

14 In the Applicant's invention, **Home Network Server 101** is part of the subscriber's system  
15 and is located on the Subscriber's premises. It is the resources of **Home Network Server**  
16 **101** that are being traded for something of value, like subsidized or free Internet access.  
17

18 **Home Network Server 101** has a number of other, important functions, in addition to  
19 acting as a proxy server for the Subscriber's Internet access. It provides the computing  
20 resources to operate the systems in the Subscriber's home. See Applicant's Application  
21 Paragraph 0026:

22 [0026] Router, Switch, or Hub 102 connects to one or more clients such as PC<sub>1</sub> 104  
23 or Sensor/Actuator<sub>1</sub> 106. More than one client PC may be used, such as PC<sub>n</sub> 105,  
24 and more than one Sensor/Actuator may be used, such as Sensor/Actuator<sub>n</sub> 107.  
25 *Sensor/Actuators are used to control and/or monitor the home's systems such as*  
26 *HVAC and Security and appliances such as refrigerators, washers, and dryers.*  
27

28 Another of the advantages of Applicant's **Home Network Server 101** is that it can run a  
29 robust, stable operating system without requiring the Subscriber to replace his software.  
30 At the time Ellis's invention was made, as well as the time the invention of the present  
31 Applicant was made, the vast majority of PCs used some version of the Microsoft Windows  
32 Operating System, and most PC Applications were available only for such systems. Thus,  
33 one advantage of Applicant's uses of **Home Network Server 101** is that the Subscriber  
34 can continue to use Microsoft Windows on his PCs without jeopardizing the safety of his  
35 home's systems.

1 In Ellis's response to the First Office Action for his application 09/320,660 he made clear  
2 the importance of being able to run applications on his **PC 1** which were not available to  
3 the operating systems typically used by servers. (The First Office Action was mailed  
4 October 14, 1999, Ellis's Response is dated April 14, 2000, and the application was  
5 eventually issued as U.S. Patent 6,167,428 .)

6  
7 From Ellis's Response, Page 24 Second Paragraph:

8  
9 The Examiner appears to have rejected claims 27-41 because of a belief that UNIX  
10 and NT servers can be run on personal computers and can be made to function  
11 temporarily as a master personal computer or as a slave personal computer, as similarly  
12 recited in claims 27-41. However, a UNIX or an NT server functions as a server, not as  
13 a master personal computer or as a slave personal computer, which require applications  
14 not found in UNIX or NT operating systems. Therefore, Applicant submits that neither  
15 Seti@home nor a UNIX or an NT server running on personal computers discloses,  
16 teaches or suggests: .....

17  
18 Ellis then discusses how this relates to his claims. However, the importance of being able  
19 to run standard PC applications on Ellis's **PC 1** has been established.

20  
21 In contrast, the value of Applicant's **Home Network Server 101** is precisely its ability to  
22 use a stable, reliable Operating System. As was previously noted, at the time Ellis's  
23 invention was made, as well as the time the invention of the present Applicant was made,  
24 the vast majority of PCs used some version of the Microsoft Windows Operating System,  
25 and most PC Applications were available only for such systems. Hence the value of having  
26 **Home Network Server 101** being able to run a stable, reliable Operating System.

27  
28 Thus, Ellis's clarification of his invention made in his Response teaches away from the  
29 invention of the present Applicant and further shows how Applicant's **Home Network**  
30 **Server 101** is distinctly different from Ellis's **Server (Network Server) 2** as well as Ellis's  
31 **PC 1** personal computer.

32

1  
2  
3 **(b) providing one or more home network client devices; (Col 13 lines 8-29, Figure 9)**  
4  
5

6 The PCs shown in Ellis Figure 9 are not home network client devices. They are networked  
7 PCs participating in parallel processing. According to Ellis Column 6 lines 49-53:

8  
9 FIG. 9 is a simplified diagram of a section of a computer network, such as the Internet,  
10 showing an embodiment of a system architecture for conducting a request initiated by a  
11 PC for a search using parallel processing means that utilizes a number of networked  
12 PC's.

13  
14 (Presumably, Ellis meant "a request *initiated* by a PC" and not "a request *imitated* by a  
15 PC.")

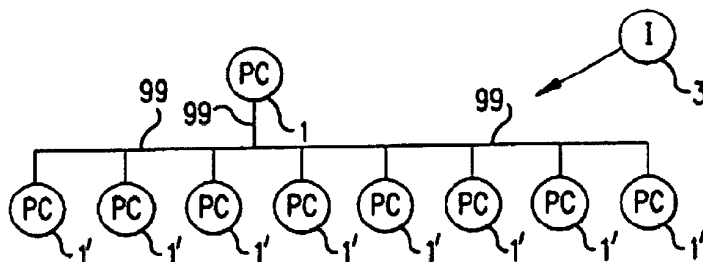
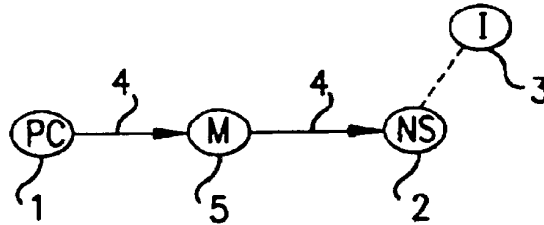

FIG.9

16  
17  
18 Applicant's invention does not use the resources of the Home Network clients for its  
19 distributed computing agreement. It uses the unused resources of **Home Network Server**  
20 **101**.

1  
2 **(c) providing an Internet connection; (Col 8 lines 7-10, Col 13 lines 4-7, Figure 1**  
3 **item 3)**

4  
5  
6  
7  
8  
9  
10  
11  
12 **Ellis Figure 1**  
13 **Item 3**



14  
15  
16  
17  
18  
19  
20  
21  
22  
23  
24  
25  
26  
27  
28  
29  
30  
31  
32  
33  
34  
35  
36  
37  
38  
39  
40  
41  
42  
43  
44  
45  
46  
47  
48  
49  
50  
51

**FIG. 1**

Both Ellis and present Applicant use the Internet. However, as detailed in Response - Part 5, Ellis's **Network Server 2** is part of the Network Provider, not Subscriber's **PC 1**. In addition, most people consider their Internet connection to start at the point where they connect to their Internet Service Provider, which is probably why it's called an **Internet Service Provider**. Applicant has followed this convention, Ellis has not.

**(d) providing access to the resources of said home network server that would otherwise be unused; (Col 11 lines 55-61, Col 12 lines 17-26, Figure 5)**

Both Ellis and present Applicant receive something of value for the use of otherwise-unused computing resources. However, Ellis's computing resources are provided by the Subscriber's **PC 1** while present Applicant provides the otherwise-unused computing resources of Subscriber's Home **Network Server 101**, which Ellis lacks. The advantage of Applicant's system has been discussed in Response - Part 7 above.

**(e) providing a first firewall between said Internet connection and said home network Server; Ellis teaches the concept of supporting the structure of inserting a firewall between the internet and home network server to provide security for the host PC against instruction by outside hackers. (Col 19 lines 25-32)**

While both Ellis and Applicant recognize the value of firewalls, Ellis does not use a home network server. Column 19 lines 25-32 refer to Ellis Figure 10A – Figure 10I, all of which

1 show **Server 2** and **Internet 3**, which as has been previously discussed, is part of the  
2 Network Provider, not Subscriber's **PC 1**.

---

3  
4  
5  
6 **(f) providing a second firewall to prevent unwanted interactions between said**  
7 **access to the resources of said home network that would otherwise be unused and**  
8 **said home network server; (Col 16 lines 33-42, Col 19 lines 19-25)**

9  
10 While both Ellis and Applicant recognize the value of firewalls, Ellis does not use a home  
11 network server. Column 16 lines 33-42 and Column 19 lines 25-32 refer to Ellis Figure 10A  
12 – Figure 10I, all of which show **Server 2** and **Internet 3**, which as has been previously  
13 discussed, is part of the Network Provider, not Subscriber's **PC 1**.

---

14  
15  
16 **whereby the subscriber receives something of value in return for said access to the**  
17 **resources of said home network server that would otherwise be unused. (Col 7**  
18 **lines 38- 48, Col 10 lines 1-6)**

19  
20 Both Ellis and present Applicant receive something of value for the use of otherwise-  
21 unused computing resources. However, Ellis's computing resources are provided by the  
22 Subscriber's **PC 1** while present Applicant provides the otherwise-unused computing  
23 resources of Subscriber's Home **Network Server 101**, which Ellis lacks. The advantage of  
24 Applicant's system has been discussed in Response - Part 7 above.

---

25  
26  
27 To summarize Applicant's response to Examiner's rejection of Claim 5:

28  
29 **1.** Ellis does not show a Home Network Server. Ellis's **server 2** is part of the Internet  
30 Service Provider's equipment and is not in the Subscriber's home.

31 **2.** As such, its computing resources are not the resources being traded by the PC User for  
32 something of value such as Internet access. Instead, it is the resources of **PC 1** which are  
33 being traded.

34 **3.** Ellis's financial arrangement requires that the PC User and the Network Provider be  
35 different entities.

36 **4.** The PCs shown in Ellis Figure 9 are not home network client devices. They are  
37 networked PCs participating in parallel processing. Applicant's invention does not use the

1 resources of the Home Network clients for its distributed computing agreement. It uses the  
2 resources of *Home Network Server 101*.

3

4 5. While both Ellis and Applicant recognize the value of firewalls, since Ellis does not use  
5 a Home Network Server, his firewall must run in Subscriber's PC (*PC 1*).

6

**Section 3.**

For the foregoing reasons, Applicant submits that all objections and rejections have been overcome. Applicant requests that the rejection of pending claims 1-5 be withdrawn and that the application be allowed as filed.

Respectfully submitted,

Jed Margolin  
pro se inventor

Jed Margolin

Date: April 21, 2005

Jed Margolin  
3570 Pleasant Echo Dr.  
San Jose, CA 95148-1916  
(408) 238-4564

I hereby certify that this correspondence is being deposited with the United States Postal Service as first class mail with sufficient postage in an envelope addressed to:

Mail Stop Amendment  
Commissioner for Patents  
P.O. Box 1450  
Alexandria, VA 22313-1450

on the date below.

Date: April 21, 2005

Inventor's Signature: Jed Margolin

## Appendix A – Definition of Server

# Server

From Wikipedia, the free encyclopedia.

*This article is about computer servers. For the food service use, see waiter.*

In computing, a **server** is:

- A computer software application that carries out some task on behalf of users. This is usually divided into file serving, allowing users to store and access files on a common computer; and application serving, where the software runs a computer program to carry out some task for the users. This is the original meaning of the term. Web, mail, and database servers are what most people access when using the internet.
- The term is now also used to mean the physical computer on which the software runs. Originally server software would be located on a mainframe computer or minicomputer. These have largely been replaced by computers built using a more robust version of the microprocessor technology than is used in personal computers, and the term "server" was adopted to describe microprocessor-based machines designed for this purpose. In a general sense, server machines have high-capacity (and sometimes redundant) power supplies, a motherboard built for durability in 24x7 operations, large quantities of ECC RAM, and fast I/O subsystem employing technologies such as SCSI, RAID, and PCI-X or PCI-Express.

**Contents** [\[hide\]](#)

[1 Usage](#)

[2 Server hardware](#)

[3 Server operating systems](#)

[4 X Window server](#)

[5 Historical note](#)

[6 See also](#)

[7 External links](#)

[\[edit\]](#)

## Usage

Sometimes this dual usage can lead to confusion, for example in the case of a web server. This term could refer to the machine which stores and operates the websites, and it is used in this sense by companies offering commercial hosting facilities. Alternatively, *web server* could refer to the software, such as the Apache HTTP server, which runs on such a machine and manages the delivery of web page components in response to requests from web browser clients.



1 [edit]

## 2 **Server hardware**

3 A server computer shares its resources, such as peripherals and file storage, with the users'  
4 computers, called clients, on a network. It is possible for a computer to be a client and a server  
5 simultaneously, by connecting to itself in the same way a separate computer would.

6 Many new devices now come with server capabilities. The X-Internet, Web Services, and  
7 Microsoft's .NET initiative all work to make even the smallest system a server.

8 Many large enterprises employ numerous servers to support their needs. A collection of servers in  
9 one location is often referred to as a server farm. It is possible to configure the machines to  
10 distribute tasks so that no single machine is overwhelmed by the demands placed upon it (called  
11 load balancing), and this is often done for hosts that expect tremendous amounts of activity. The  
12 terminology can be even more confusing in this case because the client (or user) will connect to a  
13 remote host to access the server application, and that server application may need to access other  
14 server software and/or another server machine.

15 Due to the continual demand for ever more powerful servers in ever decreasing spaces, companies  
16 such as IBM have developed higher density configurations, the most notable of which is known as  
17 the blade server. Blade servers incorporate a number of server computers - sometimes as many as  
18 nine - each housed inside a high-density module known as a "blade", within the space typically  
19 occupied by a single computer.

20 [edit]

## 21 **Server operating systems**

22 The rise of the microprocessor-based server was facilitated by the development of several versions  
23 of the Unix operating system to run on the Intel microprocessor architecture, including Solaris,  
24 Linux and FreeBSD. The Microsoft Windows series of operating systems also now includes server  
25 versions that support multitasking and other features required for servers, beginning with Windows  
26 NT. The current Windows Server version is Windows Server 2003.

27 [edit]

## 28 **X Window server**

29 The X Window System can cause some confusion in the definition of servers and clients. One might  
30 expect that the "server" in X would be the computer in which individual programs are running. In  
31 reality, an X server provides access to computer input and output devices, such as monitors,  
32 keyboards, and mice. Programs that are running in an X environment connect to the server to gain  
33 access to the hardware. In most situations, both the X server, and the X clients (programs) reside on  
34 the same computer, but X allows for situations where clients can be running on multiple computers  
35 that are miles away.

1 [\[edit\]](#)

## 2 **Historical note**

3 Mainframes and minicomputers were originally accessed using dumb terminals, which were unable  
4 to carry out any significant processing. This largely ended with the widespread use of personal  
5 computers by users.

6 [\[edit\]](#)

## 7 **See also**

- 8 • [Mail server](#)
- 9 • [Web server](#)
- 10 • [FTP server](#)
- 11 • [image server](#)
- 12 • [Central ad server](#)
- 13 • [server log](#)
- 14 • [streaming media server](#)
- 15 • [sound server](#)
- 16 • [peer-to-peer](#)
- 17 • [client-server model](#)
- 18 • [History of computing hardware \(1960s-present\)](#)
- 19 • [CORBA](#)
- 20 • [Dedicated server](#)

21 [\[edit\]](#)

## 22 **External links**

- 23 • [System support for scalable network](#)
- 24 [servers](http://www.cs.rice.edu/CS/Systems/ScalaServer/) (*http://www.cs.rice.edu/CS/Systems/ScalaServer/*)
- 25 • [The C10K problem](http://www.kegel.com/c10k.html) (*http://www.kegel.com/c10k.html*)
- 26 • [Discussion "Writing a scalable](#)
- 27 [server"](http://groups.google.de/groups?group=comp.programming.threads&threadm=580fae16.0312210310.1410bf2b%40posting.google.com) (*http://groups.google.de/groups?group=comp.programming.threads&threadm=580f*  
28 *ae16.0312210310.1410bf2b%40posting.google.com*)

29

30 Retrieved from "<http://en.wikipedia.org/wiki/Server>"

31 **Views**

- 32 • [Article](#)
- 33 • [Discussion](#)
- 34 • [Edit this page](#)

1 • [History](#)

2 **Personal tools**

3 • [Create account / log in](#)

4 **Navigation**

5 • [Main Page](#)

6 • [Community portal](#)

7 • [Current events](#)

8 • [Recent changes](#)

9 • [Random page](#)

10 • [Help](#)

11 • [Donations](#)

12 **Search**

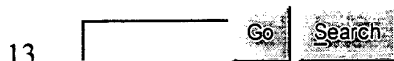

14 **Toolbox**

15 • [What links here](#)

16 • [Related changes](#)

17 • [Special pages](#)

18 **In other languages**

19 • [Български](#)

20 • [Česky](#)

21 • [Dansk](#)

22 • [Deutsch](#)

23 • [Español](#)

24 • [Suomi](#)

25 • [Français](#)

26 • [□□□](#)

27 • [תִּירְבֵּעַ](#)

28 • [Magyar](#)

29 • [Nederlands](#)

30 • [□□□](#)

31 • [Norsk](#)

32 • [Polski](#)

33 • [Русский](#)

34 • [Simple English](#)

35 • [□□\(□□\)](#)

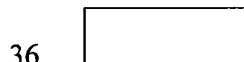

1

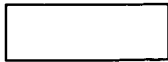

2

- This page was last modified 11:26, 24 Jan 2005.

3

- All text is available under the terms of the [GNU Free Documentation License](#) (see

4

[Copyrights](#) for details).

5

- [About Wikipedia](#)

6

- [Disclaimers](#)

7

8

9

## Appendix B – Reuters Article on Power Grid

From: <http://www.bluefish.org/facegrim.htm>

# U.S. Power Grid Faces Grim Summer

by James Jelter  
Reuters, March 30, 2001

The electricity system supporting the world's biggest economy is old, tired, and in danger of falling apart.

While U.S. regulators, power companies and the public all share blame for the system's neglect, it has taken a major energy crisis in California — the high-tech darling of the U.S. economy — to drive home just how bad things have become.

Former Energy Secretary Bill Richardson summed it up last May, when strong demand and scant supplies triggered a tenfold explosion in Western wholesale power prices: "We are a superpower economically, but we've got a grid that's almost a Third World grid."

California's economically disruptive energy woes highlight a national shortcoming exposed by 11 percent growth in the nation's population this past decade, an explosion of electrical gadgets Americans use at home and the heavy demand for power from the Internet-driven New Economy.

And an expected increase of 15 percent or more in new generation won't come fully online for another two years, leaving much of the nation extremely vulnerable to outages in what promises to be a long — and costly — summer.

Beyond California, there is a growing threat of severe energy shortages across the Western half of the country this summer.

The populous Northeast, though facing less dire shortages than the West, is also grappling with thin supplies, prompting a rush to build new power plants in New York City.

Meanwhile, constraints on the transmission grid continue to hamper the flow of energy in parts of the South.

In California, severe energy shortages have dragged the state's 34 million residents through four days of rolling blackouts so far this year, and state officials warn there are more to come.

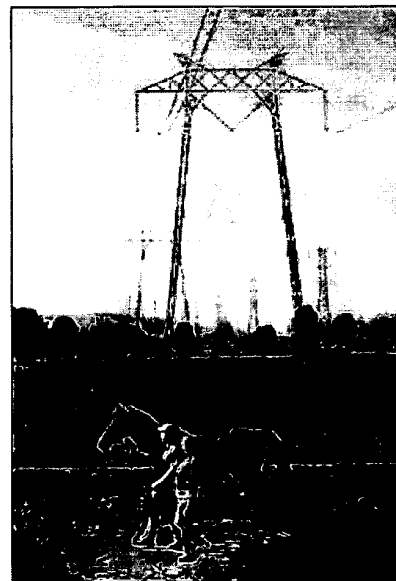

(c) 2001 Reuters

**BEST AVAILABLE COPY**

1 The California Independent System Operator, which manages most of the state's grid, predicts  
2 shortfalls this summer of up to 6,800 megawatts — enough to power 6.8 million homes — when air  
3 conditioning pushes power demand to its annual peak.

4 That translates into up to 200 hours — nearly three work weeks — of power outages statewide and  
5 possibly more if the Golden State suffers an unusually hot summer.

6 President Bush earlier this month told reporters "The energy crisis we're in is a supply-and-demand  
7 issue, and we need to reduce demand and increase supply."

8 Simply put: the United States has outgrown its power system.

9 The Energy Information Administration, the U.S. Department of Energy's statistical arm, estimates  
10 demand for electricity is growing nationwide at 2.1 percent a year.

11 But that growth rate is much higher in the West, South and parts of the Northeast, the regions  
12 experiencing the fastest population growth and hosting the strongest local economies.

13 Supporting those economies are a fleet of corporate and home computers and "server farms" — vast  
14 warehouses crammed with the computers that run the Internet.

15 The biggest of these farms use a whopping 120 megawatts around the clock, equal to the energy use  
16 of 120,000 homes and enough to merit a new mid-sized plant to serve each facility.

17 Also contributing to the surge in demand is the flood of electronic appliances filling American  
18 homes.

19 Central air conditioning, VCRs, microwave ovens, automatic garage door openers, programmable  
20 lighting and watering systems were novelties in most homes 25 years ago, if they existed at all.  
21 Many homeowners today cannot imagine life without them.

22 The Northwest Power Planning Council, an agency of the states of Idaho, Oregon, Montana and  
23 Washington, reported last month that the demand for electricity has grown 24 percent in the past  
24 decade while new generation has grown only 4 percent.

25 "When California is factored in, the gap between demand and supply is even greater," the report  
26 said.

27 Adding to the Northwest's energy worries is a severe drought, shrinking reservoirs behind some of  
28 the world's biggest hydroelectric dams to their lowest levels in 25 years and cutting deeply into  
29 available supplies.

30 During years with normal rainfall, hydro-power accounts for about 70 percent of Washington state's  
31 electricity.

1 Natural gas, used to generate about 20 percent of the nation's electricity — and up to 35 percent in  
2 California --is also in short supply, the result of several years of mild winters, low demand, and  
3 flagging drilling activity.

4 On top of these fuel shortages, the country is now coming to grips with its failure to build new  
5 power plants.

6 A decade ago, the United States enjoyed a healthy surplus of electricity, prompting a move toward  
7 deregulating the electric utility sector by introducing competition to produce a more efficient  
8 marketplace and, ultimately, cheaper energy prices.

9 But uncertainties tied to deregulation discouraged utilities from investing in new generating assets.

10 At the same time, few regulators could foresee the boom in energy demand unleashed by the  
11 technology-driven economy of the 1990s.

12 Add to this mix widespread public resistance to placing electrical gear anywhere near their  
13 neighborhood, and there were not many incentives left to spark power plant construction.

14 In the Western states, for example, it has been 10 years since a major power plant was brought on  
15 line.

16 Years of neglect also dog the nation's transmission grid, the 203,600-mile high voltage network  
17 linking power plants to neighborhood distribution lines.

18 The grid has seen few changes in 50 years. Designed to serve local utilities, deregulation has  
19 encouraged energy marketers to "wheel" their electrons ever greater distances to reach more  
20 lucrative markets.

21 This is putting a huge strain on the system, leading to bottlenecks that often create shortages rather  
22 than ease them.

23 Upgrades to the system have been slow in coming mainly because the transmission rates grid  
24 operators can charge are still tightly regulated, leaving them little financial incentive to invest in  
25 their aging lines.

26 Generators, on the other hand, are bombarded by price signals, with soaring wholesale prices  
27 screaming a clear, albeit belated, message to build more power plants.

28 Given the stream of cash being pumped into new power plants, the North American Electric  
29 Reliability Council (NERC) predicts between 109,000 and 193,000 megawatts of new generation  
30 will be in place by 2004.

31 **James Jelter**

32 *U.S. Power Grid Faces Grim Summer*

33 **Reuters**, March 30, 2001

34